



1 lockers



2 shelving



3 cupboards & work stations



4 kinetic mobile shelving



5 technic shelving



6 cloakroom



7 cabinets

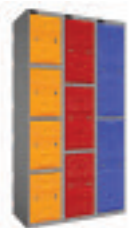

8 ultrabox plastic lockers



MEETS BS 4875-7: 2006 PART 7
AND BS 4875-8: 1998 PART 8



PROBE

SHELVING

2

KINETIC

NEW Kinetic mobile system - p2-3

IKON

Ikon shelving, an evolution - p4-7

1

2

3

4

5

6

7

8

9

ACTIVECOAT[®]
anti-bacterial technology
HYGIENIC

KINETIC MOBILE SHELVING SYSTEM

The mobile shelving system by Probe has been totally re engineered from the ground up making it easier to use and quicker to install. The brand new system incorporates safety features including a 'true' non slip floor and illuminated hand wheels indicating when the unit is in operation.

KINETIC MOBILE SHELVING

A completely freestanding mobile shelving system, no drilling, no fixing down, no messy ground or civil works. It will not damage or disturb your carpet or floor covering in any way.

HEIGHT ADJUSTABLE ANTI TILT TRACK

The unique screw adjustment from above ensures a level track even on uneven floors. This track offers an ultra safe anti-tilt mechanism and concealed end stop for safety.

INTEGRAL FLOOR

The 'true' non-slip integral floor provides a secure, rigid and safe platform to walk on.

NEW ILLUMINATED HANDWHEEL

Super bright LEDs illuminate when the motion sensors detect the wheel is in use. They stay lit for a period after the wheel has stopped, this safety feature allows others to see that the unit is being used.



PROBE KINETIC SHELVING
Below are two examples of shelving in the same area. Probes Mobile Shelving System increases shelving area by as much as **100%**.



IKON SHELVING

This shelving system is an evolution of our best selling Mistral shelving. The shelving accessories are fully compatible excluding door sets as the shelving heights have been optimised for efficient storage of contemporary storage products.

maximum bay loading:

600kg

dependent on specification

pictured: single bay

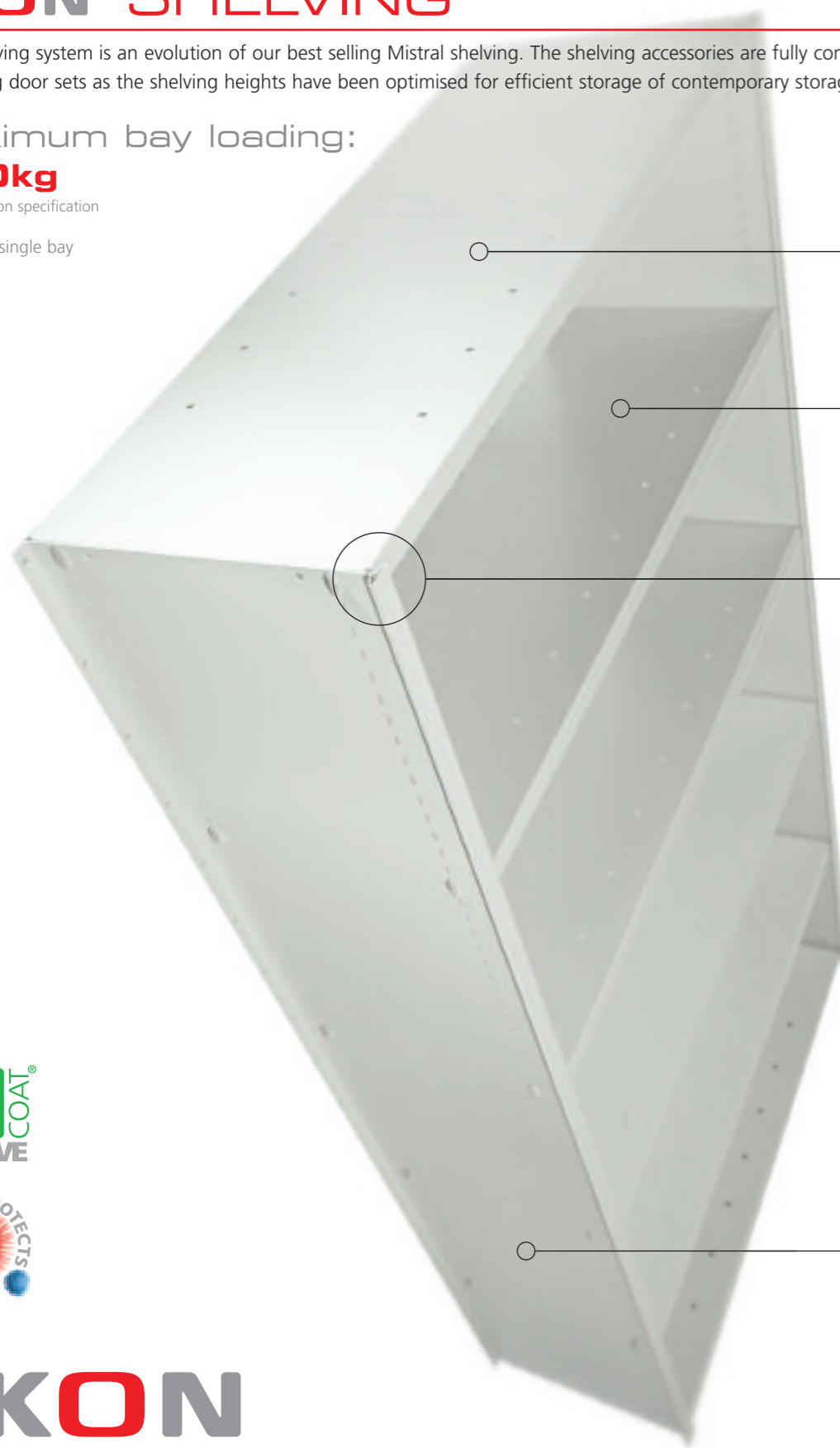

WHITE
RAL 9016

WHITE AC+IVECOAT[®]
The new hard wearing, anti-bacterial powder coating exclusively from Probe.

SHELVES
A quick and simple system to build with shelves being clipped in place.

TRUE DELTA EDGE
This, slim, True Delta Edge adds style and strength to this high quality shelving system.



A STYLISH SOLUTION
Available in three heights, six depths and with a range of special use shelves and accessories, you are sure to find what you are looking for.



3 HEIGHT OPTIONS
Uprights available in 3 heights and six depths.

SHELF OPTIONS
A range of shelves are available to suit your needs, including pull out shelves and filing cradles & frames.

DECOR END PANELS
Add the finishing touch to this stylish system with these neat decor end panels.

DOOR & FRAME SETS
These convenient door sets allow an added security feature to this universal system. Available in 1830mm & 2130mm high and 1000mm wide. Pull out shelves are not compatible with Door & Frame Sets.

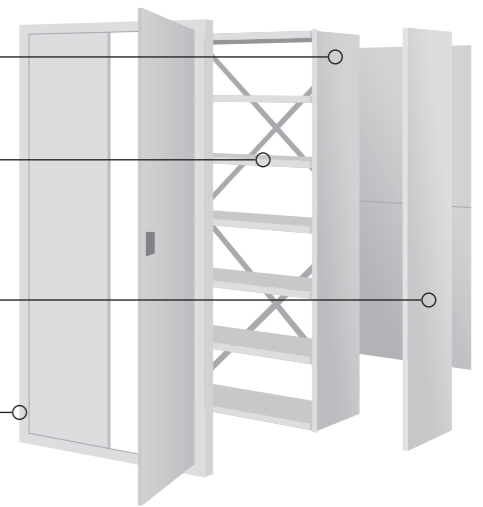

DOOR & FRAME SETS

BAY DIMENSIONS

Height (mm)	Widths (mm)			Depths (mm)				
	Sidewalls	Shelf	250	300	350	400	450	600
1830	}	750	•	•	•	•	•	•
2130		900	•	•	•	•	•	•
2430		1000	•	•	•	•	•	•
		1200	•	•	•	•	•	•

Individual shelf loading of 100kgs UDL.

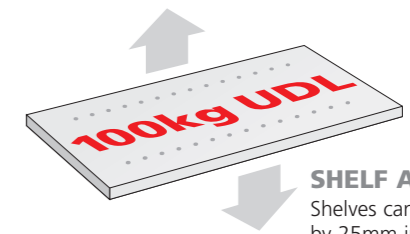

SHELF ADJUSTMENT
Shelves can be raised or lowered by 25mm increments making this system extremely versatile.

Bay bracing requirements

Maximum bay loading 600kg

dependent on specification

BAYS AERIAL VIEW

WITHOUT CLADDING

Denotes position of bracing

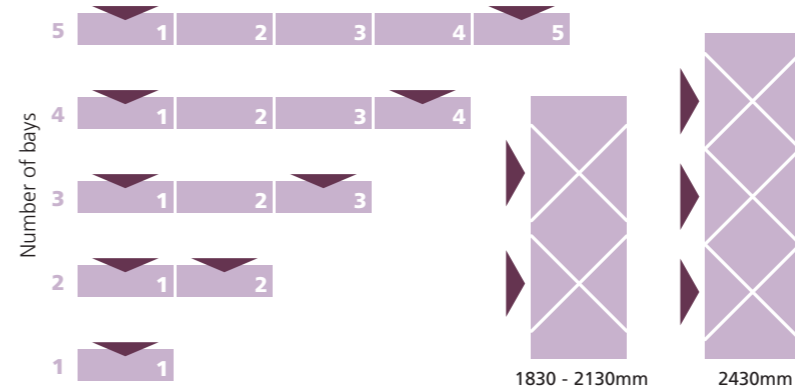

□ This system does not need bracing if fully clad.

BAY REAR VIEW

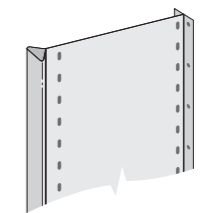

SIDEWALLS

Ikon sidewalls blend strength with appearance through innovative design and manufacture.

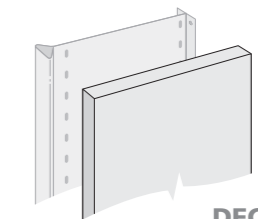

DECOR END PANELS

Ikon offers an optional Decor End Panel to add that finishing touch to this attractive system.



IKON
SHELVING

PROBE www.probe.lockers.ltd.uk

ACTIVECOAT[®] hygienic, hard wearing and anti-bacterial
anti-bacterial technology 99.9% REDUCTION OF BACTERIA INCLUDING MRSA & E-COLI for the life of the coating



IKON SHELVING

NEW maximum bay loading:

600kg

dependent on specification

NEW maximum shelf loading:

100kg



3 HEIGHT OPTIONS

A range of heights and depths are available to suit your needs.

SHELF OPTIONS

A wide range of shelf sizes and special use shelves have been made available to suit your needs.

CONVENTIONAL DOOR SET

These convenient door sets allow secure storage of valuable items within this affordable system. See opposite for space saving Tambour option.

TRUE DELTA

These True Delta uprights give this system a stylish appearance while adding strength.



FEATURES & BENEFITS

- A stylish and affordable shelving system.
- **ACTIVECOAT**[®] Probe's new hard wearing, anti-bacterial, powder coating make this system suitable for clean environments.
- Shelves may be clipped for quick and easy assembly or bolted for added strength.

IKON SHELVING

This shelving system is an evolution of our best selling Mistral shelving. The shelving accessories are fully compatible excluding door sets as the shelving heights have been optimised for efficient storage of contemporary storage products.



CLAD BAY WITH TAMBOUR DOORS

CLAD BAY

OPEN BAY



SHELF UPRIGHT HEIGHTS

ACCESSORIES



COMMERCIAL SHELF
To complement this system, a wide range of shelf options have been made available to suit your needs.

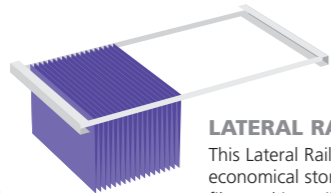

LATERAL RAIL
This Lateral Rail allows for the economical storage of hanging files and is available in two depths: 350mm & 400mm UDL 40Kg

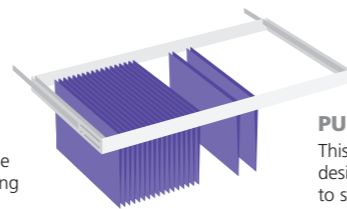

PULL OUT CRADLE*
This Pull Out Cradle is designed to give easy access to stored hanging files and is available in two depths: 350mm & 400mm UDL 40Kg

*Pull out shelves are not compatible with Door & Frame Sets.

ACCESSORIES

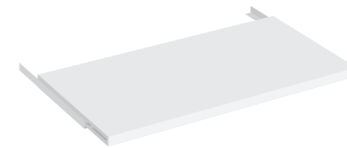

PULL OUT SHELF*
These Pull Out Shelves offer quick and convenient access to many items. UDL 40Kg

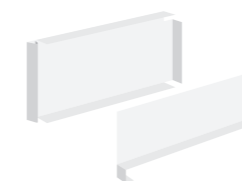

DIVIDERS
A large range of Full and Part height Dividers are available, see price guide for all options.



TAMBOUR DOORS*
These lockable Tambour doors allow an added security feature where space is at a premium including mobile shelving. Available in 1830mm and 2130mm high and 1M wide. *Pull out shelves are not compatible with Tambour Doors.

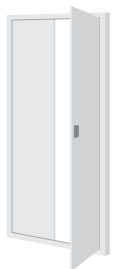

DOOR SETS*
These convenient door sets allow an added security feature to this universal system. Available in 1830mm & 2130mm high and 1M wide. *Pull out shelves are not compatible with Door & Frame Sets.

FEATURES & BENEFITS

- Quality engineered to provide a sturdy and robust shelving system that will give many years of service.
- A wide range of accessories makes this a truly flexible system to suit your needs.



www.probe.lockers.ltd.uk



ACTIVECOAT[®]
anti-bacterial technology

hygienic, hard wearing and anti-bacterial

99.9% REDUCTION OF BACTERIA INCLUDING MRSA & E-COLI for the life of the coating



TECHNIC

maximum bay loading:
500kg

dependent on specification

pictured: double sided bay

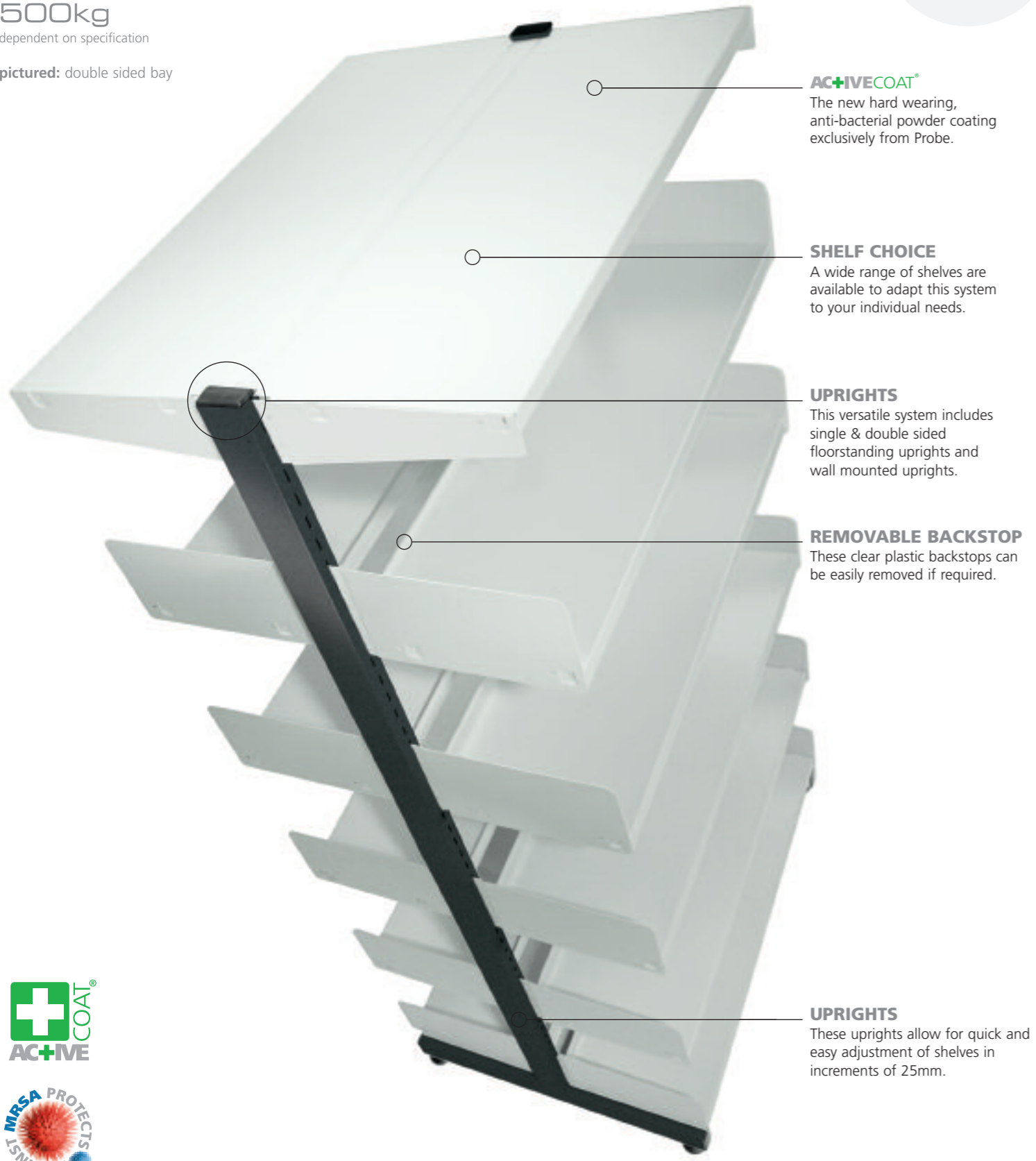

AC+IVECOAT®
The new hard wearing, anti-bacterial powder coating exclusively from Probe.

SHELF CHOICE
A wide range of shelves are available to adapt this system to your individual needs.

UPRIGHTS
This versatile system includes single & double sided floorstanding uprights and wall mounted uprights.

REMOVABLE BACKSTOP
These clear plastic backstops can be easily removed if required.

UPRIGHTS
These uprights allow for quick and easy adjustment of shelves in increments of 25mm.



For your piece of mind, Probe Technic Shelving has passed the following British Standards for strength and rigidity:
BS 4875-7: 2006 PART 7 & BS 4875-8: 1998 PART 8

SINGLE SIDED BAYS pictured right

Height (mm) Uprights	Widths (mm) Shelf
1200	750
1500	
1800	
2100	900
2300	

DOUBLE SIDED BAYS pictured left

Height (mm) Uprights	Widths (mm) Shelf
1200	750
1500	
1800	
2100	900
2300	

WALL MOUNTED BAYS pictured right

Height (mm) Uprights	Widths (mm) Shelf
1030	750
1380	
1680	
2030	900
2300	

Maximum bay loading 500kg

dependent on specification

MAXIMUM SHELF LOADING (UNIFORMLY DISTRIBUTED)		
SHELF	SIZE(mm)	UDL
Flush/Canopy Shelf	750 x 250	65kg
	750 x 300	65kg
	900 x 250	65kg
	900 x 300	65kg
Display Shelf	750	65kg
	900	65kg
Tape Cassette or CD/DVD Shelf	900	65kg
Video Shelf	900	65kg
Display & Storage Shelf	900 x 350	65kg
Standard Shelf	750 x 250	65kg
	750 x 300	65kg
	900 x 250	65kg
	900 x 300	65kg

DOUBLE SIDED BAY
Pictured with shelves on one side only

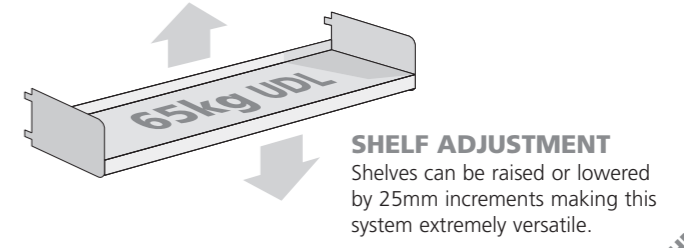
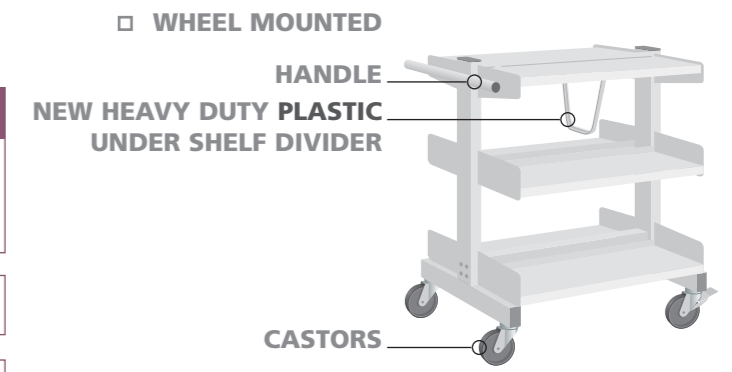
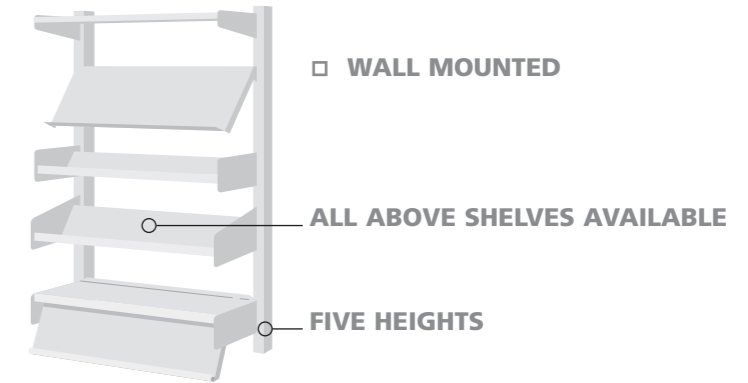
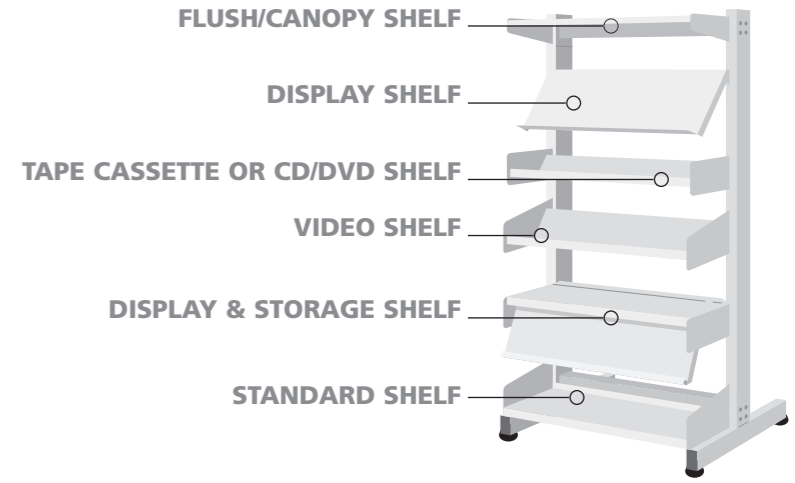

TECHNIC LIBRARY SHELVING

TECHNIC SHELVING

This versatile shelving system offers a wide range of specialist shelves and accessories to suit your business. Technic Library can be quickly adapted to meet your changing needs.



□ SINGLE SIDED BAYS
WALL MOUNTED OPTION

5 HEIGHT OPTIONS
Available in five heights 1200, 1500, 1800, 2100 & 2300mm and two depths 250 & 300mm. Note: Wall mounted available in different heights, see technical page.

SHELF OPTIONS
A wide range of shelf options has been made available to suit your needs.

A STYLISH SYSTEM
A stylish system well suited to your office environment.

QUICK BUILD
This versatile shelving system is quick and easy to construct, saving down time and minimising disturbance.



For your peace of mind, Probe Technic Shelving has passed the following British Standards for strength and rigidity:
BS 4875-7: 2006 PART 7 & BS 4875-8: 1998 PART 8

ACCESSORIES

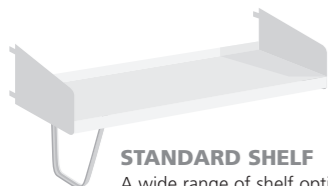

STANDARD SHELF
A wide range of shelf options are available to suit your needs. Standard shelf comes with clear plastic back stop. Pictured with optional plastic Under Shelf Divider.



DISPLAY SHELF
Display documents, brochures and products. UDL 65Kg



DISPLAY & STORAGE SHELF
This shelf is similar to the display shelf with the added facility to store a number of displayed items. UDL 65Kg

ACCESSORIES



TAPE/VIDEO CASSETTE OR CD/DVD SHELF
UDL 65Kg



FLUSH/CANOPY SHELF
Used at the top of this system to maximise storage space. UDL 65Kg

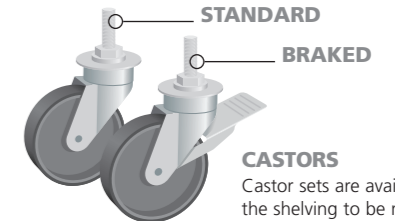

CASTORS
Castor sets are available enabling the shelving to be moved easily.

AVAILABLE COLOURS FOR TECHNIC SHELVING

All Technic units are powder coated with **ACTIVECOAT** exclusive to Probe.

RED
Similar to BS 04 E53

BLUE
Similar to RAL 5019

YELLOW
Similar to RAL 1004

GREEN
RAL 6018

WHITE
RAL 9016

SILVER
RAL 9006

BLACK
RAL 9004

□ DOUBLE SIDED BAYS



□ SINGLE SIDED BAYS WALL MOUNTED OPTION



FEATURES & BENEFITS

- Full range of optional accessories
- Adjustable feet (except wall & wheel mounted units)
- Elegant and sturdy construction
- A quick and easy to build system
- Available in a wide range of colours



www.probe.lockers.ltd.uk



ACTIVECOAT
anti-bacterial technology

hygienic, hard wearing and anti-bacterial

99.9% REDUCTION OF BACTERIA INCLUDING MRSA & E-COLI for the life of the coating



INDUSTRIAL ANGLE

maximum bay loading:

6800kg

dependent on specification

pictured: single bay

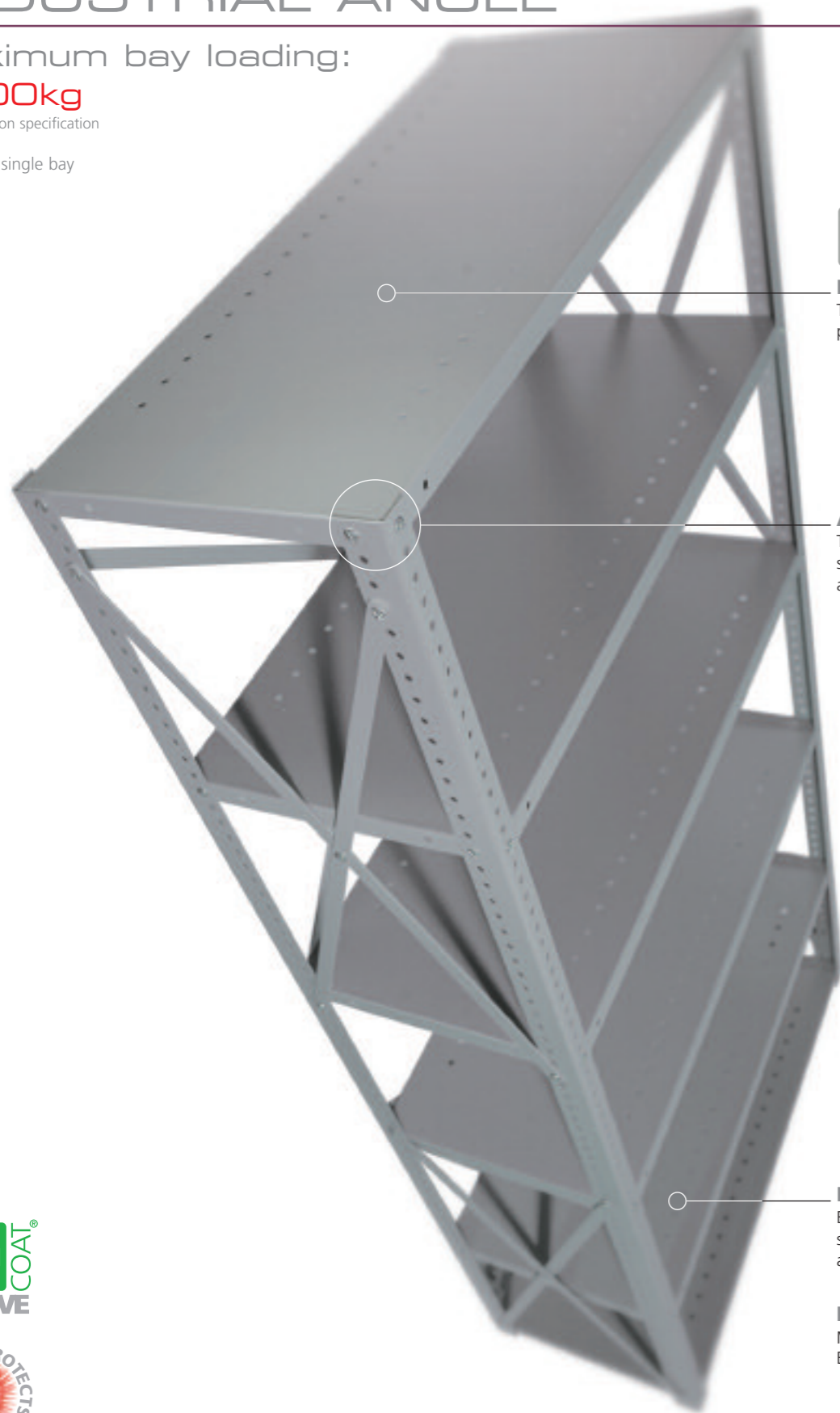

DOVE GREY
BS 694

DOVE GREY AC+IVECOAT®
The new hard wearing, anti-bacterial powder coating exclusively from Probe.

ANGLE POST
This universal system offers maximum strength for heavy industrial applications.

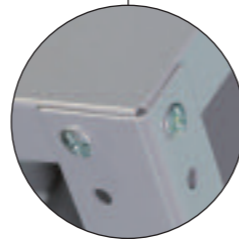

HEAVY DUTY SHELVES
Both Commercial and British Standard shelves are available in many widths and depths for maximum flexibility.

BS:826 MANUFACTURED
Manufactured in accordance with BS:826:1955

HEIGHT OPTIONS
Available in a wide range of heights and depths.

SHELF OPTIONS
A wide range of shelf sizes have been made available to suit your needs.

DOOR & FRAME SETS
These convenient door sets offer an added security feature to this universal system. Available in 75" & 87" high and 36" wide.

SHELF ADJUSTMENT
Shelves can be raised or lowered by 1" (25.4mm) increments making this system extremely versatile.

SHELF CLIPS
Shelves may be seated on clips for ease of adjustment but maximum shelf loading is reduced. Specific shelves still need to be bolted, refer to technical department for specification.

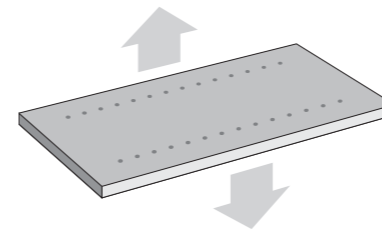

BAY DIMENSIONS

Height (inch)	Widths (inch)	Depths (inch)					
		12	15	18	24	30	36
39	24	•	•	•	•		
51		•	•	•	•		
63	30	•	•	•	•	•	
75		•	•	•	•	•	•
87	42	•	•	•	•		
99		•	•	•	•		
111	48	•	•	•	•		
123		•	•	•	•		
	1M	•	•	•	•		

Individual shelf loadings from **115-204kg UDL**

Bay bracing requirements

Maximum bay loading 6800kg

dependent on specification

BAYS REAR VIEW WITHOUT REAR CLADDING

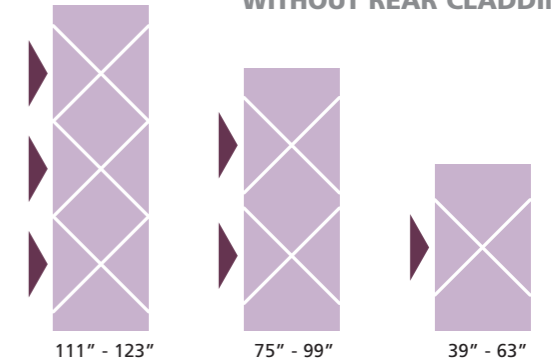

BAYS AERIAL VIEW WITHOUT CLADDING

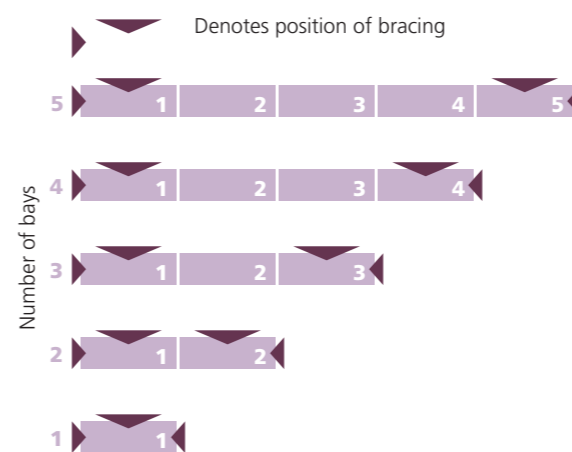

BAYS AERIAL VIEW WITH BACK CLADDING ONLY

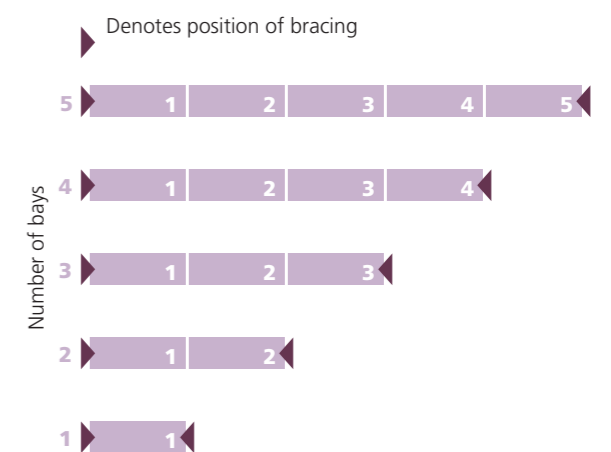

□ This system does not need bracing if fully clad.



INDUSTRIAL ANGLE
CONTINUED

PROBE

www.probe.lockers.ltd.uk



INDUSTRIAL ANGLE

INDUSTRIAL ANGLE

This shelving system offers maximum strength and flexibility. It also offers our widest range of sizes to accommodate your space and is fully compatible with any similar, third party, BSS systems you may already have.



HEIGHTS TO SUIT
Available in many standard heights and may be supplied cut to your own specification. These uprights come in two strengths, Heavy Duty and Ultra-Heavy Duty.

HEAVY DUTY SHELVES
Both Commercial and British Standard shelves are available in many widths and depths for maximum flexibility.

DOOR SET
These convenient door sets allow secure storage of valuable items within this universal system.

FEATURES & BENEFITS

- Extremely strong construction.
- Fully compatible with all similar, third party, BSS systems.
- **ACTIVECOAT®**
Probe's new hard wearing, anti-bacterial, powder coating greatly improves levels of hygiene in your environment.



FEATURES & BENEFITS

- Quality engineered to provide a shelving system that will give many years of service.
- A large range of optional accessories to accommodate your specific needs.

ACCESSORIES

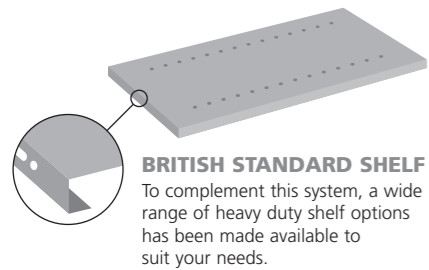

BRITISH STANDARD SHELF
To complement this system, a wide range of heavy duty shelf options has been made available to suit your needs.

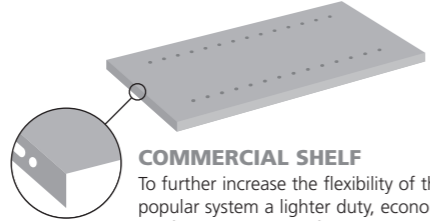

COMMERCIAL SHELF
To further increase the flexibility of this popular system a lighter duty, economical, shelf has been added for those applications where ultimate strength is not required.

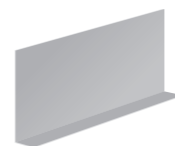

PART HEIGHT SHELF DIVIDER
These dividers are designed for easily creating individual part height compartments on shelves.

ACCESSORIES

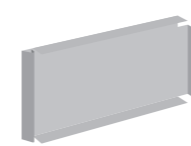

SHELF DIVIDER
These dividers are perfect for creating individual compartments on shelves and are available in a range of depths and heights.



RETAINING BIN FRONT AND PLINTH
Retaining Bin Fronts are easily fixed to shelves preventing items rolling off. Plinths fit to bottom of bay preventing items rolling under.



DOOR SETS
These convenient door sets allow an added security feature to this universal system. Available in 75" & 87" high and 36" wide.

ROLLED EDGE

maximum bay loading:
500kg

dependent on specification

pictured: single bay

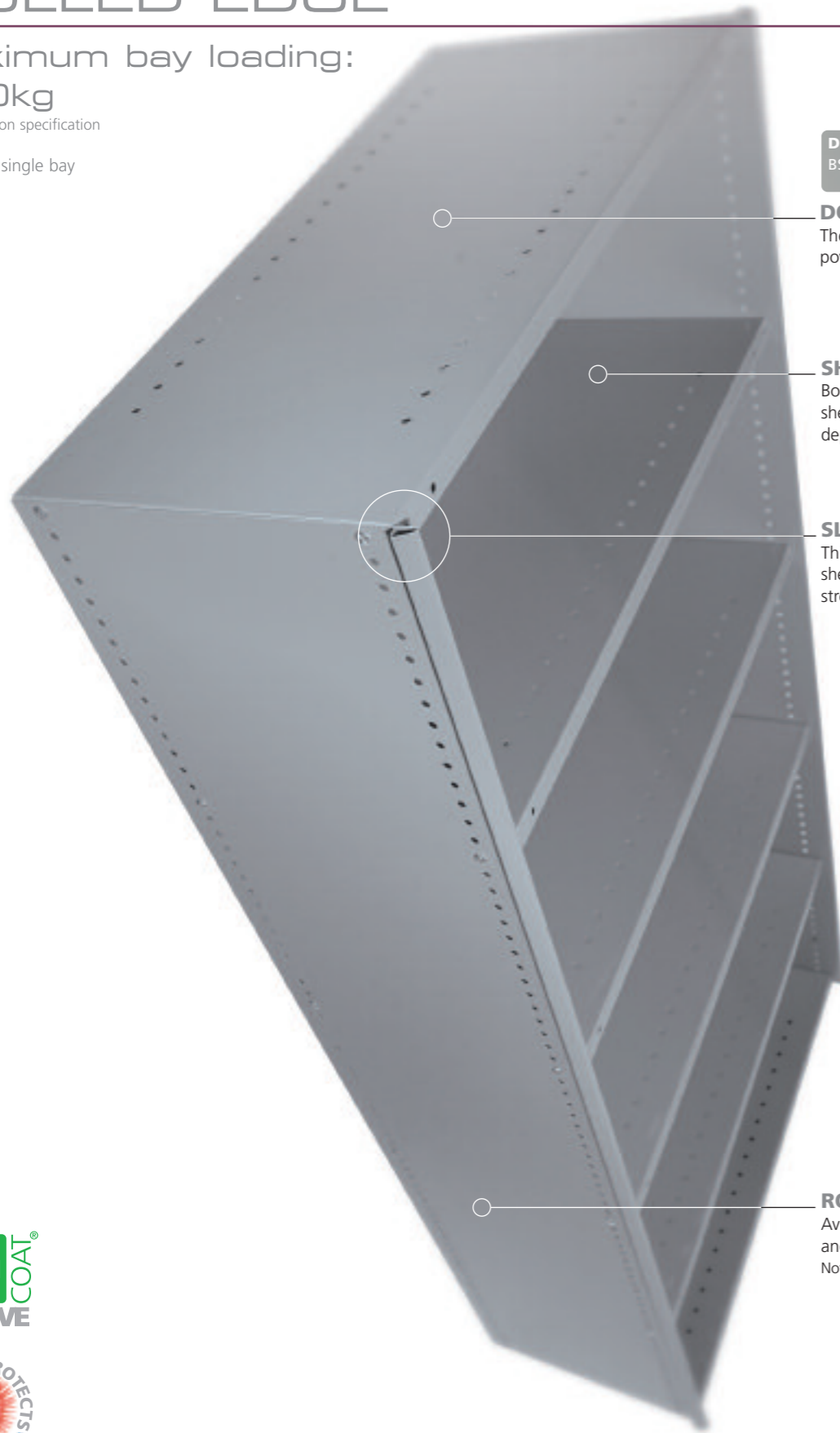

DOVE GREY
BS 694

DOVE GREY AC+IVECOAT®
The new hard wearing, anti-bacterial powder coating exclusively from Probe.

SHELVES
Both Commercial and British Standard shelves are available in many widths and depths for maximum flexibility.

SLIM VERTICAL EDGE
This, slim, rolled edge allows maximum shelf width to be used while adding strength to this system.

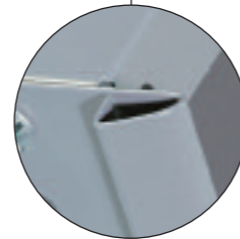

ROLLED EDGE UPRIGHTS
Available in three heights 75", 87" & 99" and four depths 12", 15", 18" & 24".
Note: 99" not available in 24" depth.



3 HEIGHT OPTIONS
75" 87" and 99" uprights in a choice of depths.

4 SHELF DEPTHS & 6 WIDTHS
A wide range of shelf options have been made available to suit your needs. Not all depths are available with all widths, see price guide for a comprehensive list.

SPECIAL USE SHELVES
See the next page for the full range of pull out and filing shelves.

DOOR & FRAME SETS
These convenient door sets allow an added security feature to this universal system. Available in 75" & 87" high and 36" wide.

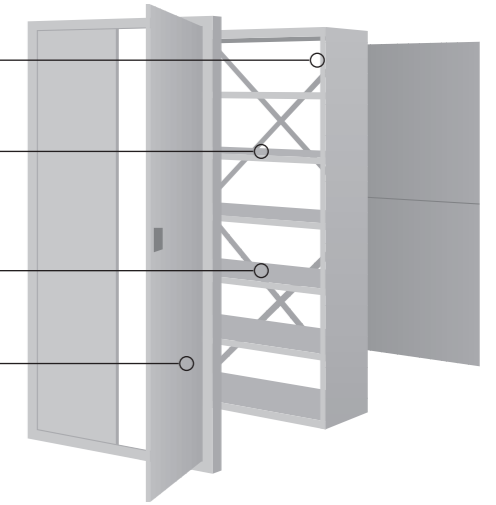

BAY DIMENSIONS

Height (inch)	Widths (inch)	Depths (inch)			
		12	15	18	24
75	24"	•	•	•	•
	30"	•	•	•	•
87	36"	•	•	•	•
	1M	•	•	•	•
99	42"	•	•	•	•
	48"	•	•	•	•

Individual fixed shelf loadings **90-205kgs UDL**
See price list for individual shelf loadings.

PULL OUT SHELVES

Height (mm)	Widths (mm)	Depths (mm)	
		15"	18"
75	36"	•	•
		•	•
87	36"	•	•
99	36"	•	•

Individual shelf loading of 40kgs UDL.

PULL OUT FILE CRADLE

Height (mm)	Widths (mm)	Depths (mm)	
		15"	18"
75	36"	•	•
		•	•
87	36"	•	•
99	36"	•	•

Individual cradle loading of 40kgs UDL.

LATERAL FILING FRAME

Height (mm)	Widths (mm)	Depths (mm)	
		15"	18"
75	36"	•	•
		•	•
87	36"	•	•
99	36"	•	•

Individual filing frame loading of 40kgs UDL.

SLIM VERTICAL EDGE

Slim Vertical Edge rolled for added strength and style. Pictured with optional Decor End Panels to finish off bay ends neatly.

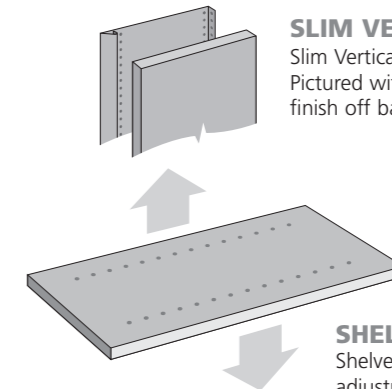

SHELF ADJUSTMENT
Shelves can be raised or lowered by 1" (25.4mm) increments making this system extremely versatile.

SHELF CLIPS

Shelves may be seated on clips for ease of adjustment but maximum shelf loading is reduced. Specific shelves still need to be bolted, refer to technical department for specification.

Bay bracing requirements

Maximum bay loading 500kg
dependent on specification

BAYS AERIAL VIEW

WITHOUT CLADDING

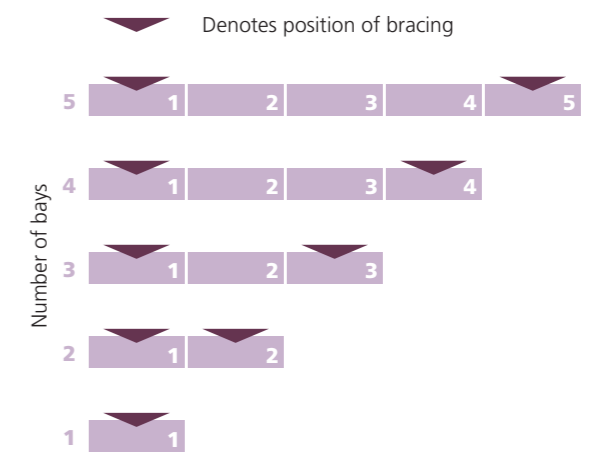

BAY REAR VIEW



□ This system does not need bracing if fully clad.

ROLLED EDGE
CONTINUED



ROLLED EDGE

ROLLED EDGE

This neat shelving system with its Slim Vertical Edge gives increased access to shelves and is fully compatible with all, third party, rolled edge shelving systems.



3 HEIGHT OPTIONS

Available in three heights 75", 87" & 99" and four depths 12", 15", 18" & 24". Note: 99" not available in 24" depth.

4 SHELF DEPTHS AND 6 WIDTHS

A wide range of shelf options have been made available to suit your needs.

Not all depths are available with all widths, see price guide for a comprehensive list.

DOOR SET

These convenient door sets allow secure storage of valuable items within this universal system.

SLIM VERTICAL EDGE

This, slim, rolled edge allows increased access to shelves and gives added strength to this neat system.

FEATURES & BENEFITS

- Slim Vertical Edge giving increased access to shelves.
- Fully compatible with all, third party, rolled edge shelving systems.
- Shelves may be clipped for quick and easy assembly or bolted for added strength.



FEATURES & BENEFITS

- Quality engineered to provide a sturdy and robust shelving system that will give many years of service.
- **ACTIVECOAT®**
Probe's new hard wearing, anti-bacterial, powder coating greatly improves levels of hygiene in your environment.

ACCESSORIES

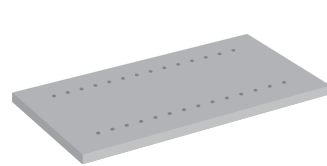

SHELVES

To complement this system, a wide range of shelf options have been made available to suit your needs.

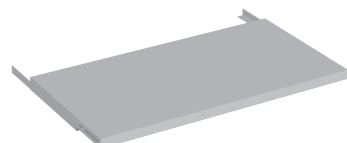

PULL OUT SHELF

These Pull Out Shelves offer quick and convenient access to many items.
UDL 40Kg

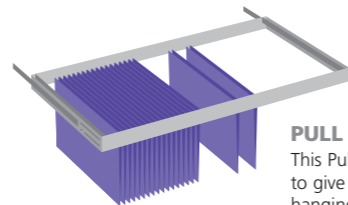

PULL OUT CRADLE

This Pull Out Cradle is designed to give easy access to stored hanging files and is available in two depths: 15" & 18"
UDL 40Kg

ACCESSORIES

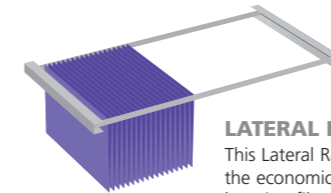

LATERAL RAIL

This Lateral Rail allows for the economical storage of hanging files and is available in two depths: 15" & 18"
UDL 40Kg

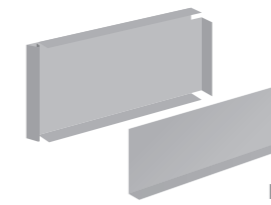

DIVIDERS

A large range of Full and Part height Dividers are available, see price guide for all options.



DOOR SETS

These convenient door sets allow an added security feature to this universal system.
Available in 75" & 87" high and 36" wide.



www.probe.lockers.ltd.uk
info@probe-lockers.ltd.uk

tel: 01244 677 585
fax: 01244 241 175



ACTIVECOAT®
anti-bacterial technology

hygienic, hard wearing and anti-bacterial

99.9% REDUCTION OF BACTERIA INCLUDING MRSA & E-COLI for the life of the coating

