

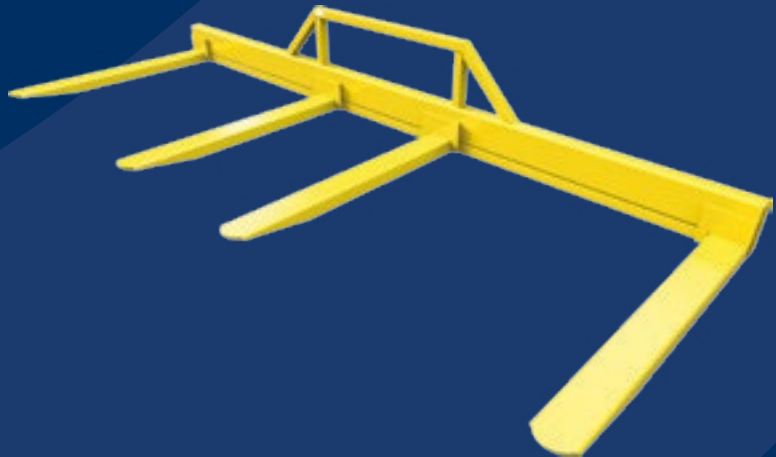

Forklift Attachments Best Sellers Product Overview

Solving all your **Material Handling Needs**



We Tick All The Boxes

3 Year Guarantee

In-House Manufacturing

ISO 9001 Quality Procedures

No Quibble Guarantee

Spare Parts

Full Testing & Certification

Thorough Examination (Loler) Testing

Custom Design Solutions

On-Site Product Training

About Us

Established in 1974, we entered the material handling market as one of very few suppliers, with an initial product range of forklift scoops, fork extensions and lifting jibs. Our product range has grown since those early days, and we now offer one of the largest ranges of material handling equipment in the UK.

Quality has always been at the core of our business, and we pride ourselves on offering our customers the very best products which provide true value for money.

Our enviable reputation in the industry is a result of consistently providing the highest standards of services to our customers.



1985 - Early model drum rotator

Our Support

- ✓ **1st Class Customer Service**
- ✓ **Industry Experience**
- ✓ **Expert Help & Guidance**

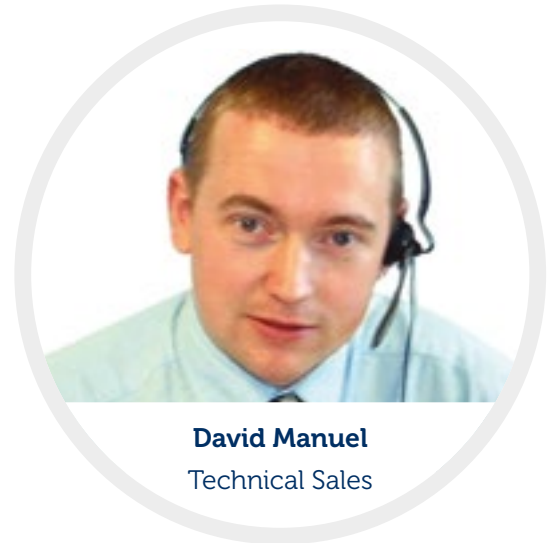

David Manuel
Technical Sales



Tipping Skips



Lids



Auto Release Kits



Mesh Extensions

Suitable for use in a multitude of industries, our forklift tipping skips help keep working areas clear and allow safe and speedy removal of scrap or rubbish to the appropriate waste receptacle or collection point.

Regular duty 3mm (Also available in Heavy duty 'HD' 5mm)

Model Ref	Vol Capacity (m3)	Load Capacity (kg)
RFS 25L	0.25	1000
RFS 40L	0.40	1000
RFS 80L	0.80	1000
RFS 120L	1.20	1250
RFS 160L	1.60	1500
RFS 200L	2.00	1500

We can also produce our skips with a galvanised finish or from stainless steel, whatever your skip requirement, we can help.



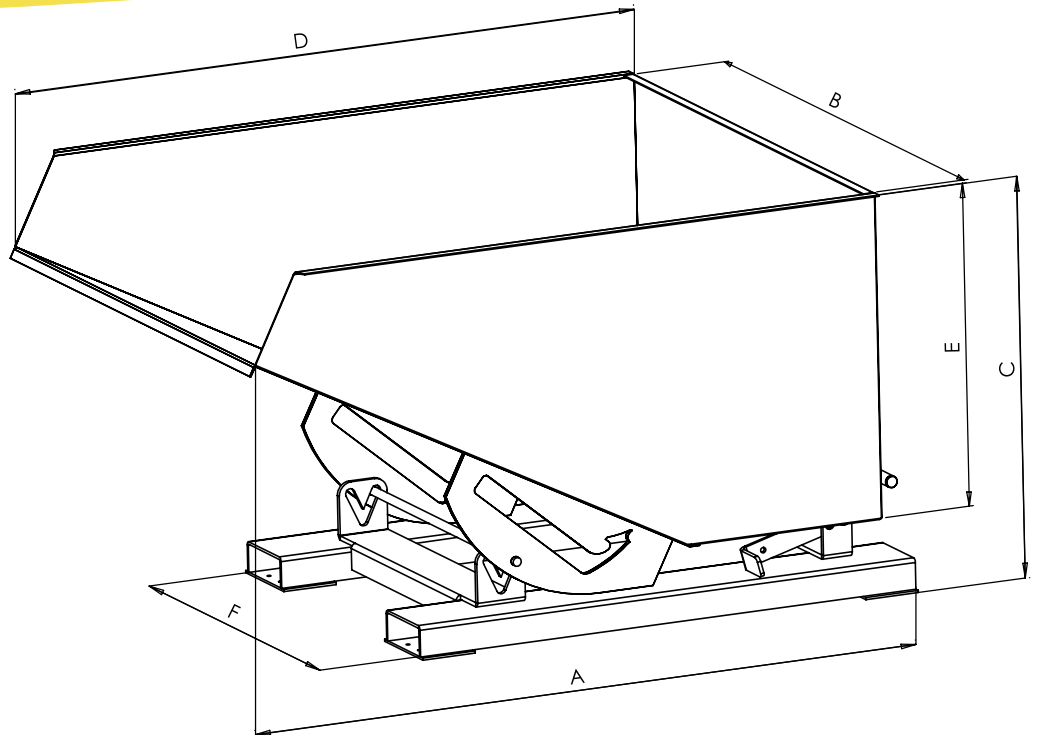

**Maximum Fork Section
150 x 60mm**

Model Ref	Length A (mm)	Width B (mm)	Height C (mm)	Bin Length D (mm)	Bin Height E (mm)	Fork Spread F (mm)
RFS 25L	1148	794	678	1025	547	890
RFS 40L	1410	794	781	1197	547	890
RFS 80L	1710	900	985	1540	750	890
RFS 120L	1710	1300	985	1540	750	890
RFS 160L	1710	1700	985	1540	750	890
RFS 200L	1710	2125	985	1540	750	890

We also offer



Base emptying stillages



Low loading skips



Tidy bins



Wheelie bin handlers

Forklift Forks



Our forks are supplied using only the most reputable steel plants and the highest quality of steel.

Fully tested and approved, you can be assured our fork arms meet the latest international standards (including ISO 2328).

Whatever the requirement, whatever the capacity, we can offer forks to fit any conceivable application.

Stainless Steel
Inverted Fork Arms
Full Taper
Hydraulic

All configurations



FEM



Square Plate



Pin/Bar



Terminal West



Forklift Extensions

- ✓ Heavy Duty 5mm Pressing
- ✓ Fully Rounded Toe Section
- ✓ Additional 8mm Internal Plates
- ✓ Closed Base Rear Strap Design

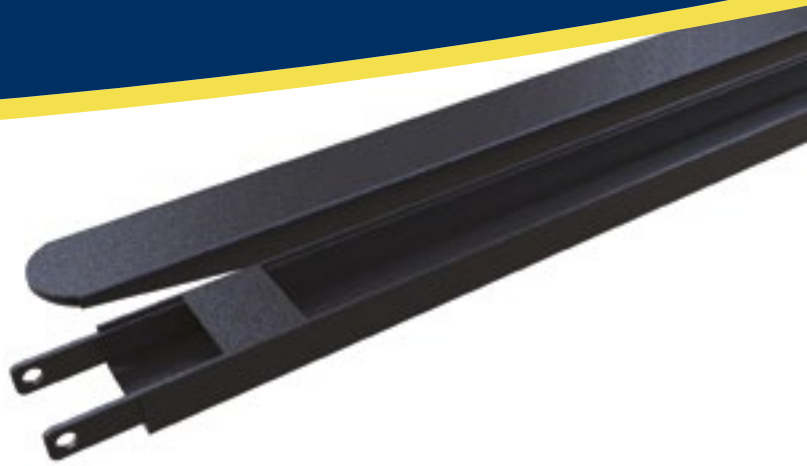

A superior fork extension, designed to offer occasional long reach and stabilising capabilities when the forklift forks are not long enough.

To suit 100mm wide forks up to 40mm thick

Model Ref	Extension Length (mm)	Extension Width (mm)
FEX100-1500	1500	136
FEX100-1650	1650	136
FEX100-1800	1800	136
FEX100-2000	2000	136

To suit 125mm wide forks up to 50mm thick

Model Ref	Extension Length (mm)	Extension Width (mm)
FEX125-1500	1500	161
FEX125-1650	1650	161
FEX125-1800	1800	161
FEX125-2000	2000	161

Other widths & lengths are available to suit your specific fork requirements.

We also offer



Fork protection sleeves



Radius top sleeves



Coil support sleeves



Triangular sleeves

Spark Resistant - ATEX



We Can Help

If you are using your forklift attachment or piece of material handling equipment in a potentially hazardous and explosive atmosphere, then you must ensure your equipment will not cause an explosion during routine operation.

We can manufacture our attachments entirely from spark proof stainless steel to comply with the ATEX Directive.



What constitutes a hazardous area?

An area where a potentially explosive mix of air and flammable gases or air and dust, or air dust & gases may occur.



Zones & Definitions

European & IECEx classification	Definition of zone
Zone 0 (gases/vapours)	An area in which an explosive mixed atmosphere is consistently present for long periods.
Zone 1 (gases/vapours)	An area in which an explosive mixture is likely to occur in normal operation.
Zone 2 (gases/vapours)	An area in which an explosive mixture is not likely to occur in normal operation and if occurs, will persist for a short time.
Zone 20 (dusts)	An area in which explosive atmosphere in the form of cloud of combustible dust in air is consistently present for long periods.
Zone 21 (dusts)	An area in which an explosive atmosphere in the form of a cloud of combustible dust is likely to occur in normal operation occasionally.
Zone 22 (dusts)	An area in which an explosive atmosphere in the form of a cloud of combustible dust in air is not likely to occur in normal operation, but if does, will persist for a short time.



Drum Handling

Drum Grab

The entry-level drum grab designed solely for handling steel drums with rolling hoops. Ideal for low to medium movement of drums around the factory or store. Fully automatic in operation.



FDH-1

Suitable for drum types



Model Ref	SWL (kg)	No. of Drums	Max Fork Size (mm)	Fork Spread (mm)
FDH-1	500	1	140 x 50	560
FDH-2	1000	2	140 x 50	880



FDH-2

Suitable for drum types



All our drum handling equipment is 'CE' marked, fully tested and certified to comply with latest Health & Safety Regulations.



Universal Drum Grab

With a simple to use 'two-position' adjustment, the Universal Drum Grab can handle both 210 litre steel drums and 210 litre 'L' & 'XL' ring plastic drums.



Suitable for drum types



Model Ref	SWL (kg)	No. of Drums	Max Fork Size (mm)	Fork Spread (mm)
FDHU-1	500	1	140 x 50	560

Mauser Drum Grab

Designed for use with 210 litre Mauser open top and tight head egg-shaped plastic drums. Arms close automatically around the base of the drum holding it securely during transportation.



Suitable for drum types



Model Ref	SWL (kg)	No. of Drums	Max Fork Size (mm)	Fork Spread (mm)
FDHM-1	380	1	150 x 70	585

Drum Handling

Rim Grip Drum Handler

The drum handler to choose for handling drums packed tightly together. Steel jaws grip the rim of the drum, allowing the drums to be picked up or set down without spaces between them.

Suitable for drum types



PB-1



PB-2

Safe & Secure
Drum Gripping

Model Ref	SWL (kg)	No. of Drums	Max Fork Size (mm)	Fork Spread (mm)
PB-1	750	1	140 x 50	560
PB-2	1500	2	140 x 50	560



Drum Rotator

Offering safe, smooth and effortless drum rotation, drums are held firmly in place by two webbing straps/ratchets to prevent drum slippage.

High quality gearbox connected to either a crank handle or loop chain allows for controlled drum pouring below shoulder height or above.

DTR-1



Model Ref	SWL (kg)	Max Fork Size (mm)	Min Width Required Between Forks (mm)	Method of Operation
DTR-1	360	140 x 50	656	Crank Handle
DTR-2	360	140 x 50	656	Loop Chain

Suitable for drum types



DTR-2



All our drum handling equipment is 'CE' marked, fully tested and certified to comply with latest Health & Safety Regulations.

Drum Handling

Fork Drum Positioner

A means of manipulating drums from the horizontal position to vertical and vice versa without leaving the seat of the fork truck. The four tine model allows drums to be stacked in racking where clearance above the drums is minimal.



Suitable for drum types



Model Ref	SWL (kg)	No. of Tines	No. of Drums	Max Fork Size (mm)	Fork Spread (mm)
FDP-1	400	3	1	140 x 50	567
FDPF-1	400	4	1	140 x 50	567

Drum Key (210 Litre)



Steel



Plastic



Fibre



Mauser



Your Peace of Mind

40 Years Experience

With over 40 years experience in the forklift attachment and material handling industry, we have built up an enviable reputation by supplying top quality products to clients worldwide. Manufactured to strict ISO 9001 procedures at our site in Mid Wales, all of our products are designed to meet the rigours of everyday industry – all whilst ensuring real value for money.

Our skilled workforce, innovative design team, and dedicated customer support are all ready and waiting to help with any material handling problem you may have.



Spare Parts

Over time, your attachment may need the occasional spare part, and it's important that you have them available if you need them. We offer a full range of spare parts for all our manufactured products, so if you need to replace that broken spring, or damaged clamp, then we'll get you back up and running with minimal downtime.



Full Testing & Certification

All our products come fully tested and certified in accordance with the Machinery Directive (Directive 2006/42/EC of the European Parliament). We take Health & Safety seriously, and in doing so ensure you're supplied with a product that meets all HSE requirements.



Thorough Examination

Although we'll supply you with a Thorough Examination (Loler) test certificate to cover you for the first 12 months (or 6 months product dependant) from date of supply, as a CFTS accredited company, we can also help you with your Thorough Examination renewal certificates, which, just like a car's MOT, is required on a periodic basis by law.



On-Site Product Training Service

Once you've bought an attachment from us, our service doesn't have to end there. Although every single one of our products come supplied with clear operating instructions, sometimes having a 'hands on' approach can really help, and we'd be delighted to offer you our on-site product training.



Forklift Platforms

Contact's forklift safety platforms offer a strong, safe and stable working deck from which to carry out un-scheduled and occasional emergency tasks where there could be an immediate risk to personnel.

Such tasks (i.e. maintenance work, light bulb replacement, building / racking inspection) can be carried out in a safe controlled manner.



All our platforms comply fully with HSE Guidance Note PM28 (Fourth Edition).

Model Ref	Width x Length (mm)	No. of Persons	SWL (kg)	Max Fork Size (mm)	Fork Spread (mm)
WP-STD-MARK-4	1000 x 1000	1-2	500	150 x 60	920
WP-GATED	1000 - 1220	1-2	500	150 x 60	794

We also offer



Crane slung platforms



Emergency rescue platforms



Goods transfer platforms



Wide Load Stabilisers

Fixed Four Fork

Designed for use when handling extra wide pallets or long product such as steel or plastic pipes, steel flats, plastic extrusions or timber. The truck forks slide into the inner sleeves and the outer forks support and balance the load.



Tailor made to suit your exact load handling requirements.

Available in widths from 1500mm to 5000mm

Model Ref	Max SWL (kg)
FFA-1	1000
FFA-2	2000
FFA-3	3000
FFA-4	4000
FFA-5	5000

Adjustable Four Fork

Designed for use when handling extra wide loads where the pallet width varies. The outer forks can be moved in or out to suit the variations in pallet or load.



Models 2500-3000 wide, Maximum lateral adjustment 750mm per fork
Models 3500-5000 wide, Maximum lateral adjustment 1000mm per fork

Model Ref	Max SWL (kg)
AFFA-1	1000
AFFA-2	2000
AFFA-3	3000
AFFA-4	4000
AFFA-5	5000

Push Broom Sweepers



ES-1800

- ✓ Robust Steel Shroud
- ✓ Quick & Easy Fitment
- ✓ No Moving Parts
- ✓ Low Maintenance

Offering simple yet cost effective sweeping, our range of push broom sweepers caters for all types of working conditions and environments – whether it's sweeping the warehouse floor of packaging waste or keeping the farmyard clean, we have a sweeper to suit.

Model Ref	Broom Width (mm)	No. of Rows	Max Fork Size (mm)	Best For
ES-ECO	1800	5	180 x 80	Lightweight Sweeping (Warehouse)
ES-1800	1800	8	180 x 80	Medium to Heavy Sweeping (Yard)
ES-HD	1800	11	140 x 50	Heavy Arduous Sweeping (Building Site)



Replaceable bristles ensures the service life of the sweeper is extended for years to come.



Snow Plough

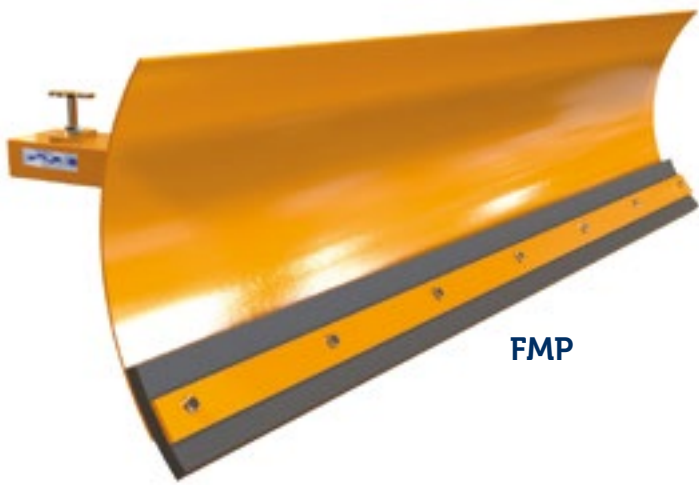

FMP



Also available
in Adjustable &
Sprung Loaded
Models

Utilising heavy duty rolled steel, our most popular 'Fixed' blade snow plough comes fully equipped for ploughing the heaviest and most compacted of snow.

Model Ref	Ploughing Width (mm)	Max Fork Size (mm)	Max Fork Spread (mm)
FMP 1220	1250	140 x 50	830
FMP 1525	1600	140 x 50	830
FMP 1830	1900	140 x 50	830
FMP 2130	2200	140 x 50	830

Optional Extras:

- Rubber Blade Inserts
- Castors

We also offer



Pedestrian snow plough



Towable salt spreader



Pedestrian salt spreader





Custom Design Solutions



If you can't find an 'off the shelf' solution to your material handling problem, then don't despair - our innovative design team can make an attachment for you, tailored specifically for your needs.

With a proven track record of helping many of our customers across the UK, our dedicated design team are on hand to talk through your requirements.

5 Steps to Your Perfect Solution

Specification	Design	Approval	Manufacture	Support
				
<ul style="list-style-type: none">• On site consultation• Liaise directly with our designers	<ul style="list-style-type: none">• Latest Solidworks technology• Stress analysis• Modern design techniques	<ul style="list-style-type: none">• Full rendering of photo realistic imagery• Customer approval process	<ul style="list-style-type: none">• ISO 9001 quality procedures• Coded welders• In-house UK manufacturing	<ul style="list-style-type: none">• Test certification• Product rating• Thorough Examination

If you need a 'be-spoke' solution to your material handling, we'd love to hear from you

Call Us On **+44 (0)1686 611 200**



Goods Cage

Designed with lift up gates each side and fold down ramps to facilitate the loading/unloading of goods.

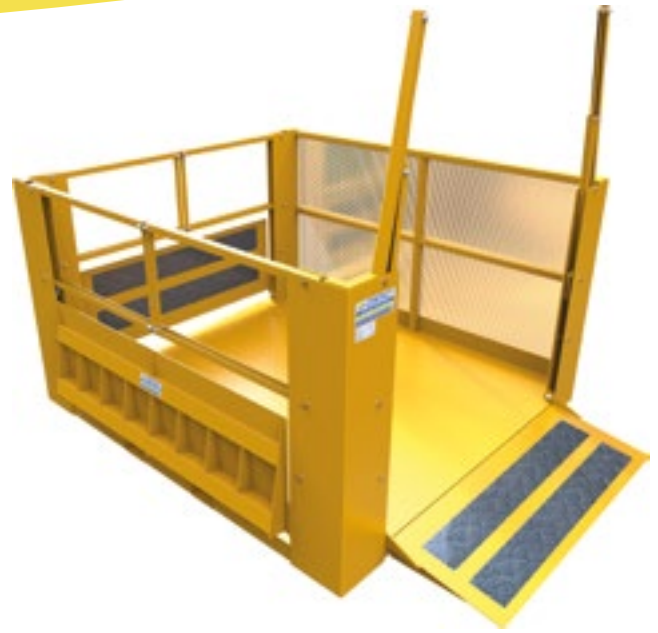

Cylinder Grab

This squeeze clamp design allowed large Calor gas cylinders to be handled safely on the forklift forks.



Roller Tines

Produced to aid the loading/unloading of military aircraft.



Hydraulic Grab

With shore 60A polyurethane coated jaws, this hydraulic drum handler proved ideal for handling large volume mixed types drums.

Lifting Jibs



Lowliner Jib

An inexpensive jib which gives longer reach capabilities for picking up a product which is difficult to palletise or for handling motors, press tools etc from positions which are hard to access.

Supplied c/w hook and shackle which can be moved to suit any suitable lifting position.

Don't forget, we also supply lifting gear equipment such as hooks, shackles, chain slings etc.

Model Ref	Truck Capacity (kg)	Max Fork Size (mm)	Fork Spread (mm)
LLJ 500-0.8	1000	140 x 50	370
LLJ 500-1.0	1300	140 x 50	370
LLJ 500-1.3	1500	140 x 50	370
LLJ 500-1.8	2000	140 x 50	370
LLJ 500-2.2	2500	140 x 50	370
LLJ 500-2.7	3000	180 x 80	470
LLJ 500-3.1	3500	180 x 80	470
LLJ 500-3.5	4000	180 x 80	470
LLJ 500-4.4	5000	180 x 80	470

Jib Selection & Capacity Chart

Model Ref	Load Capacity Carrying Capacity at Load Centre Shown						
	Truck Capacity @500mm (kg)	500mm	750mm	1000mm	1250mm	1500mm	1750mm
LLJ 500-0.8	1000	800	650	500	380	310	230
LLJ 500-1.0	1300	1000	800	630	470	388	280
LLJ 500-1.3	1500	1300	900	680	500	450	380
LLJ 500-1.8	2000	1800	1400	1100	900	720	580
LLJ 500-2.2	2500	2200	1800	1400	1100	1000	850
LLJ 500-2.7	3000	2700	2050	1450	1200	1100	900
LLJ 500-3.1	3500	3100	2500	1900	1500	1200	1000
LLJ 500-3.5	4000	3500	2700	2000	1600	1300	1100
LLJ 500-4.4	5000	4400	3400	2700	2200	1850	1400





Fork Mounted Jib

A fixed length jib which mounts onto the forks of any truck. The ideal attachment for lifting and conveying loads which are not suitable for, or do not require palletising.

Supplied c/w hook and shackle which can be moved to suit any suitable lifting position.

All our lifting jibs are 'CE' marked, fully tested and certified to comply with latest Health & Safety Regulations.

Model Ref	Truck Capacity (kg)	Max Fork Size (mm)	Fork Spread (mm)
FMJ 500-0.8	1000	140 x 50	510
FMJ 500-1.0	1300	140 x 50	510
FMJ 500-1.3	1500	140 x 50	510
FMJ 500-1.8	2000	140 x 50	510
FMJ 500-2.2	2500	140 x 50	510
FMJ 500-2.7	3000	180 x 80	590
FMJ 500-3.1	3500	180 x 80	590
FMJ 500-3.5	4000	180 x 80	590
FMJ 500-4.4	5000	180 x 80	590

Jib Selection & Capacity Chart

Model Ref	Load Capacity Carrying Capacity at Load Centre Shown				
	Truck Capacity @500mm (kg)	1000mm	1250mm	1500mm	1750mm
FMJ 500-0.8	1000	500	380	310	230
FMJ 500-1.0	1300	630	470	388	280
FMJ 500-1.3	1500	680	500	450	380
FMJ 500-1.8	2000	1100	900	720	580
FMJ 500-2.2	2500	1400	1100	1000	850
FMJ 500-2.7	3000	1450	1200	1100	900
FMJ 500-3.1	3500	1900	1500	1200	1000
FMJ 500-3.5	4000	2000	1600	1300	1100
FMJ 500-4.4	5000	2700	2200	1850	1400

Lifting Jibs



Tele-Liner Jib

All the benefits of the 'lowliner jib' but with the added feature of a mechanically extending inner section for extra reach.

Supplied with two hooks which allow extra long loads to be carried safely.

- Closed Length:** 2000mm
- Extended Length:** 3000mm

Model Ref	Truck Capacity (kg)	Max Fork Size (mm)	Fork Spread (mm)
LLX 500-1.8	2000	140 x 50	390
LLX 500-2.2	2500	140 x 50	390
LLX 500-2.7	3000	180 x 80	540
LLX 500-3.1	3500	180 x 80	540
LLX 500-3.5	4000	180 x 80	540
LLX 500-4.4	5000	180 x 80	540

Jib Selection & Capacity Chart

Model Ref	Load Capacity Carrying Capacity at Load Centre Shown											
	Truck Capacity @500mm (kg)	500 mm	750 mm	1000 mm	1250 mm	1500 mm	1750 mm	2000 mm	2250 mm	2500 mm	2750 mm	3000 mm
LLX 500-1.8	2000	1800	1400	1100	900	720	580	500	360	330	260	210
LLX 500-2.2	2500	2200	1800	1400	1100	1000	850	750	560	440	320	230
LLX 500-2.7	3000	2700	2050	1450	1200	1100	900	840	670	490	360	270
LLX 500-3.1	3500	3100	2500	1900	1500	1200	1000	900	730	580	450	370
LLX 500-3.5	4000	3500	2700	2000	1600	1300	1100	1000	820	670	540	460
LLX 500-4.4	5000	4400	3400	2700	2200	1850	1400	1100	900	750	620	500





Extender Jib

Allows transport of long loads. The two hooks provided allow loads to be slung at greater centres than with a conventional fixed jib. The greater length available allows loads to be picked up from otherwise inaccessible areas.

Closed Length: 2000mm

Extended Length: 3000mm

Don't forget, we also supply lifting gear equipment such as hooks, shackles, chain slings etc.

Model Ref	Truck Capacity (kg)	Max Fork Size (mm)	Fork Spread (mm)
FMX 500-1.8	2000	140 x 50	510
FMX 500-2.2	2500	140 x 50	510
FMX 500-2.7	3000	180 x 80	590
FMX 500-3.1	3500	180 x 80	590
FMX 500-3.5	4000	180 x 80	590
FMX 500-4.4	5000	180 x 80	590

Jib Selection & Capacity Chart

Model Ref	Load Capacity Carrying Capacity at Load Centre Shown									
	Truck Capacity @500mm (kg)	1000 mm	1250 mm	1500 mm	1750 mm	2000 mm	2250 mm	2500 mm	2750 mm	3000 mm
FMX 500-1.8	2000	1100	900	720	580	500	360	330	260	210
FMX 500-2.2	2500	1400	1100	1000	850	750	560	440	320	230
FMX 500-2.7	3000	1450	1200	1100	900	840	670	490	360	270
FMX 500-3.1	3500	1900	1500	1200	1000	900	730	580	450	370
FMX 500-3.5	4000	2000	1600	1300	1100	1000	820	670	540	460
FMX 500-4.4	5000	2700	2200	1850	1400	1100	900	750	620	500

Lifting Hooks



Fork Mounted Hook - Adjustable

The most cost effective way of safely hanging a load under the forks of your lift truck. Simply clamps onto the forks, anywhere along their length.

Model Ref	Max SWL	Max Fork Size (mm)	Fork Spread (mm)
FMHA-1.0	1000	140 x 50	678
FMHA-2.0	2000	140 x 50	678
FMHA-3.0	3000	140 x 50	678
FMHA-4.0	4000	180 x 80	758
FMHA-5.0	5000	180 x 80	758

Lifting Gear

To compliment our range of lifting jibs and hooks, we also supply a comprehensive range of lifting gear equipment and accessories.

- ✓ **Pewag Chain Sling Systems**
- ✓ **Hooks & Shackles**
- ✓ **Container Lifting Lugs**
- ✓ **Lifting & Lashing Points**
- ✓ **Much More...**

pewag



Attachments for Telehandlers

Versatile

Designed for the construction and plant hire industry, our range of attachments include:

Snow Ploughs, Safety Cages, Fork Carriages, Lifting Hooks, Waste Skips, Buckets, Platforms, Sweepers, Lifting Jibs & many more...



Quality

With over 40 years dedicated experience in the material handling industry, we have built up an enviable reputation by supplying quality products worldwide.



Supplied with brackets to suit

CAT TH62, JCB Q Fit
Manitou, Matbro,
Merlo
& many more...

Contact Attachments Ltd
Unit E, Mochdre Industrial Estate
Newtown
Powys, SY16 4LE
Wales, United Kingdom

Freephone: 0800 028 3332 (UK)
International: +44 (0)1686 611 200
Fax: +44 (0)1686 611 201
sales@forklift-attachments.co.uk

Interested in starting a discussion?
We would be delighted to hear from you!

Call Us On 0800 028 3332