

cubicle centre

www.washroomcubicles.co.uk



UK Manufacturer of Toilet Cubicles & Washroom Systems

Company Introduction	03		
Cubicle Product Guide	04		
Material Guide	05		
Pendle	06	40	
Pendle Junior	07	41	
Pennine	09	42	
Malvern	10	43	
Malvern Plus	11	44	
Grampian	13	45	
New Cambrian	14	46	
Cairngorm	15	47	
Privacy	17	48	
Cotswold	19	49	
Brecon	21	50	
Brecon CGL	22	50	
			Sydney 24 52
			Sydney CGL 25 52
			Vanity Unit Kits 26 53
		New CGL Vanity Units 27 53	
		Wall Panel Systems 28 54	
		Pendle Panel System 29 55	
		Healthcare IPS 30 31	
		Cistern-Box Kits 32	
		New Lockers & Benches 33	
		New Trevi Panel Shower Panels 34 35	
		New Acrylic Splashbacks 36 37	
		Increased Height WC Cubicles 51	
		Toilet Cubicle Sizes (Guidelines) 38	
		FAQ 56	
		Sanitary Ware 59	

We are always looking to ensure the wood used to make our products comes from the most responsible sources available. Certain MFC colours can be supplied as FSC® Certified on request. Simply look out for the FSC 'ticktree' logo in this brochure.



The mark of responsible forestry

Wood sourced from responsibly managed forests

To learn more about the Forest Stewardship Council®, visit www.fsc.org



Some people think a cubicle is just a cubicle, but we take our business seriously.

The smallest rooms in the building can lead to the biggest frustrations. At Cubicle Centre we are working hard to make your life as easy as possible.

Why Choose Cubicle Centre

For architects and specifiers

- We provide a full library of 2D CAD and 3D BIM (Building Information Modelling) files for all our products
- Specification sheets provide a detailed overview of each product
- Our "Create Specification" tool provides a custom specification in seconds

For contractors and fitters

- Some of the shortest lead times in the industry
- Support throughout the design and build of your project
- Detailed fitting and installation instructions

For the end user

- Excellent quality products (even budget ranges have robust fittings)
- A cubicle range to suit any environment or budget
- Committed to using responsibly sourced wood-based materials

Cubicle Centre is an award winning, family run business that specialises in the manufacture of washroom panel products. We won "SME of the Year" and "Best of the Best" in the Constructing Excellence Awards.

We can also supply sanitary ware, brassware and washroom accessories to complete your project. These products are available to buy online at Plumbware.co.uk (a Cubicle Centre brand).

Not sure which cubicle system is right for you?
Questions about installation, specifications or design?

Contact our friendly team for technical and buying advice:

Tel: (01924) 457 600
Email: sales@washroomcubicles.co.uk

Cubicle Centre
Caldervale Business Park, Ravensthorpe, West Yorkshire, WF13 3JL

Cubicle Product Guide

Fast-Track Pendle Systems

	Price Range	Lead Times* (Working Days)	Material	Fittings	Colours**	Pages Product	Specification
Pendle	Low-Medium	3 - 5	MFC	PVC / SAA	5 options	Pg 06	Pg 40
Pendle Junior	Low-Medium	3 - 5	MFC	PVC / SAA	2 options	Pg 07	Pg 41
Pendle Panels	Low - Medium	3 - 5	MFC	Suspension Fittings	7 options	Pg 29	Pg 55

Made to Measure Cubicles

	Price Range	Lead Times* (Working Days)	Material	Fittings	Colours**	Pages Product	Specification
Pennine	Low	5 - 7	MFC	SAA	4 colours	Pg 09	Pg 42
Malvern	Low-Medium	5 - 7	MFC	SAA (Anti-Vandal)	8 colours	Pg 10	Pg 43
Malvern Plus	Medium	7 - 10	MFC	SAA (Anti-Vandal)	145 colours	Pg 11	Pg 44
Grampian	High	15	HPL	SAA (Anti-Vandal)	160 colours	Pg 13	Pg 45
Cambrian	Medium - High	10 - 12	CDF	Heavy Duty SAA	24 colours	Pg 14	Pg 46
Cairngorm	Medium - High	10 - 12	CGL	Heavy Duty SAA	144 colours	Pg 15	Pg 47
Privacy	High	10 - 12	CGL	Heavy Duty SAA	51 colours	Pg 17	Pg 48
Cotswold	High	20	CGL	Robust (Powder Coated)	144 colours	Pg 19	Pg 49
Brecon	Medium	10 - 12	MFC	Powder Coated or SAA	24 colours	Pg 21	Pg 50
Brecon CGL	Medium - High	10 - 15	CGL	Heavy Duty SAA	144 colours	Pg 23	Pg 50
Sydney	Medium	10 - 12	MFC	SAA / Magnetic Catch	24 colours	Pg 24	Pg 52
Sydney CGL	Medium - High	10 - 15	CGL	SAA / Magnetic Catch	144 colours	Pg 25	Pg 52

Vanity Units & Panel Systems

	Price Range	Lead Times* (Working Days)	Material	Fittings	Colours**	Pages Product	Specification
Vanity Unit	Low - Medium	10 - 15	MFC/HPL	Metal Bracket System	7 stock	Pg 26	Pg 53
CGL Vanity Unit	Medium - High	15	CGL	Metal Bracket System	144 colours	Pg 27	Pg 53
Wall Panels	Low - Medium	10 - 15	All 3	Suspension Fittings	Matching	Pg 28	Pg 54
Healthcare IPS	Medium - High	20	HPL	Suspension Fittings	10 HPL stock	Pg 30	Pg 31
Cistern-Box Kits	Low - Medium	10 - 15	All 3	Suspension Fittings	Matching	Pg 32	Pg 32
Trevi Panel	Medium	10	MR MDF	Satin Silver Channels	28 colours	Pg 34	Pg 35
Splashbacks	Low - Medium	15 - 20	Acrylic	Attachment Adhesive	18 acrylics	Pg 36	Pg 37

* Lead times may increase during busier periods of the year (I.E. school holidays).

** Colour option are subject to change due to suppliers.

Material Guide

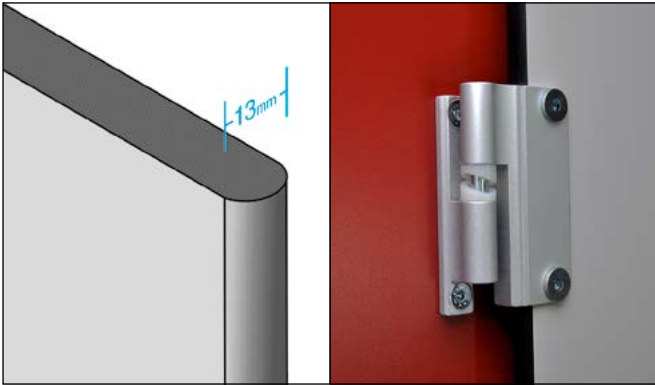

Compact Grade Laminate (CGL)

Constructed from multiple layers of high quality kraft paper, reinforced by thermosetting resins under high pressure and temperature. This produces tough, high density, totally waterproof and hygienic panels that have a high level of strength.

All visible CGL panel edges are machined to a smooth round profile.

CGL is the ideal choice for washroom and changing room areas that have very high traffic.

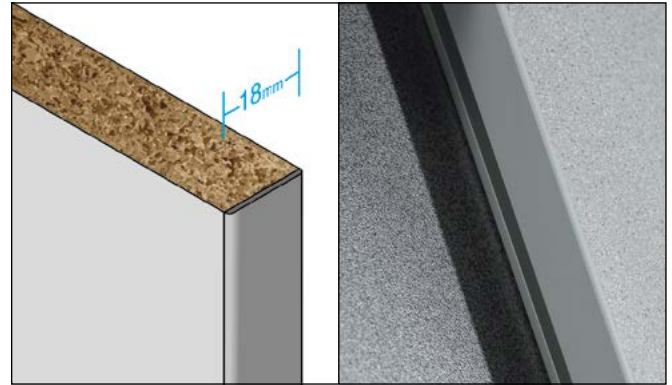

Melamine Faced Chipboard (MFC)

Melamine Faced Chipboard incorporates a decorative melamine surface bonded to both sides of high density chipboard under high pressure and temperature.

All visible MFC panels have impact resistant, PVC edging applied.

MFC is a cost effective, hygienic and lightweight solution for all non-wet toilet areas.

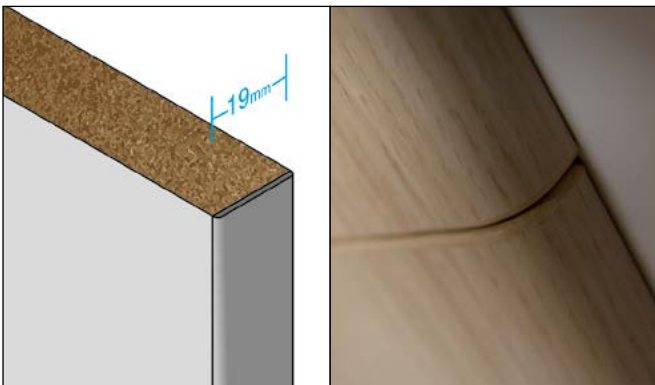

High Pressure Laminate (HPL)

Constructed from layers of high quality kraft paper, reinforced by thermosetting resins under high pressure and temperature with one decorative surface. The result is a hygienic 0.8mm thick flexible sheet material.

HPL is bonded onto a high density coreboard to produce a strong finished panel. Panels can be post-formed to create a seamless, curved edge detail.

HPL is suitable for use in areas of high traffic and reasonably demanding conditions.

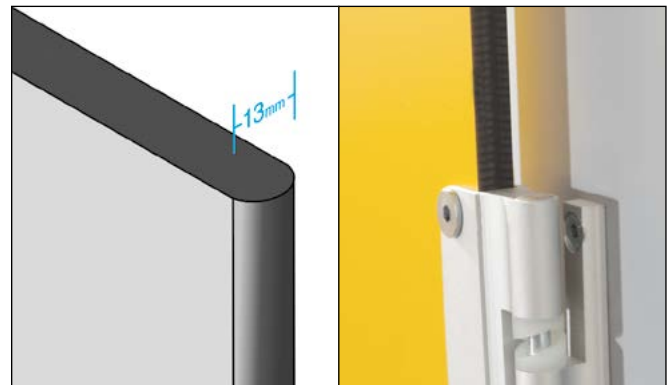

Compact Density Fibreboard (CDF)

CDF is a robust high density, black coloured wood fibreboard. Stability, scratch resistance and splash water resistance are among the characteristics of this sophisticated natural wood composite.

All visible CDF panel edges are machined to a smooth round profile.

CDF is an excellent choice when additional durability is required.



Three enclosed cubicles requires - x3 Box A (Door Pack) and x2 Box B (Partition Pack)



Pendle

Specification: [Page 40](#)

A box packed toilet cubicle system suited for all dry areas. Comprising of Box A (Door Pack) and Box B (Partition Pack), containing all necessary panels and fittings.

Usually dispatched within 48 hours of order

Box packed for ease of transport and handling

Adjustable on-site

Durable panels with tough PVC edging

Smoke Blue, Grey, Plain Grey, White or Woodgrain Options



Indicator Face



Cubicle Leg



Cubicle Latch



Full-Height Hinge



Two enclosed cubicles requires - x2 Box A (Door Pack) and a Box B (Partition Pack)



Pendle Junior

Specification: Page 41

A box packed toilet cubicle system suited for Junior school washrooms. Comprising of Box A (Door Pack) and Box B (Partition Pack), containing all necessary panels and fittings.

Usually dispatched within 48 hours of order

Box packed for ease of transport and handling

Adjustable on-site

Durable panels with tough PVC edging

Two door colour options - Blueberry or Dragon Fruit (above)



Indicator Face



Cubicle Leg



Curved Door



Full-Height Hinge

Pennine cubicles offer a level of durability not normally associated with a budget range.

Brackets and hinges are through-bolt types that provide a strong and secure cubicle fixing.





Speckled Grey option

Pennine

Specification: Page 42

Suited for use in dry areas where function and price are the most important factors. Pennine offers all the key functional qualities required for a practical washroom environment.

Budget range

Fast-Track delivery

Melamine Faced Chipboard (MFC)

Solid PVC edging

Available in Speckled or Plain Grey, White or Cream



Indicator Face



Cubicle Leg



Cubicle Latch



Hidden Safety Hinge



Plain Grey Panels with Red Doors
Speckled Anthracite Vanity Top with Plain Grey Panels



Malvern

Specification: Page 43

Developed for the refurbishment market, Malvern cubicles consist of durable panels and tamper proof fittings. We can dispatch custom-made cubicles within 5 to 10 working days thanks to smart stocking and fast custom manufacturing.

Fast-Track delivery

Melamine Faced Chipboard (MFC)

Tough PVC edging (Light Grey)

Anti-vandal cubicle fittings

Choice of 8 colour options for cubicle doors

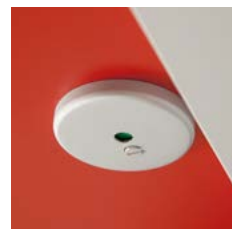

Indicator Face



Adjustable Cubicle Leg

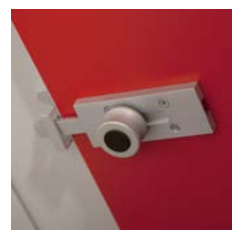

Cubicle Latch

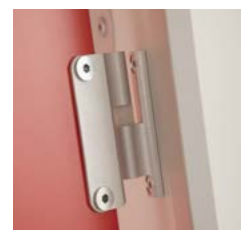

Hidden Safety Hinge



Choose from over 100 colours online

Malvern Plus

Specification: Page 44

To the same specification as Malvern, this cubicle system offers anti-vandal cubicle fittings and a wide colour choice as standard.

Made to measure

Melamine Faced Chipboard (MFC)

Matching PVC edging

Anti-vandal cubicle fittings

Choice of over 100 colours

Available in an increased height configuration (See page 51)

www.washroomcubicles.co.uk

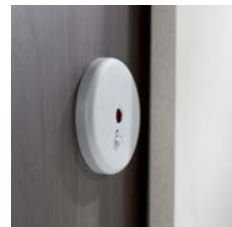

Indicator Face



Adjustable Cubicle Leg



Pilaster Bracket



Secure Hinge Face Plate



A tough cubicle system suited for areas of high traffic and reasonably robust conditions - manufactured using High Pressure Laminate.

See pages 28 and 54 for details on Wall Panels Systems.



Rovere Zadar doors and panels with Grigio Argento partitions and vanity top

Grampian

Specification: Page 45

A robust cubicle system with panels manufactured from High Pressure Laminate (HPL) bonded onto high density coreboard.

Made to measure

High Pressure Laminate (HPL)

Post-Formed pilasters available @ extra cost

Anti-vandal cubicle fittings

15 standard colours / 145 non-standard colours

Available in an increased height configuration (See page 51)

www.washroomcubicles.co.uk



Indicator Face



Adjustable Cubicle Leg



Secure Hinge Face Plate



Hidden Safety Hinge

New



Colours Azul Star and Amarillo Sol

Cambrian

Specification: Page 46

When your cubicles need to be that bit more durable to perform in a tougher environment, our Cambrian range is the answer. Constructed from Compact Density Fibreboard (CDF) these cubicles offer stability a step above our chipboard ranges.

Cambrian is splash resistant, but is not suitable for shower cubicles.

Made to measure

Compact Density Fibreboard (CDF)

Robust alternative for your toilet cubicles

Heavy duty fittings

Available in an increased height configuration (See page 51)

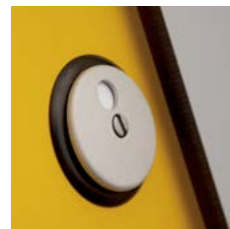

Indicator Face



Wide Base Cubicle Leg



Robust 'Single Action' Latch

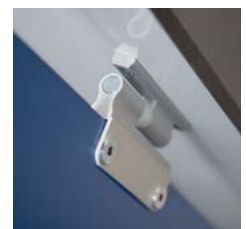

Hidden Safety Hinge



Grigo Argento doors with Rosso Oriente partitions

Cairngorm

Specification: Page 47

Designed to perform in even the most demanding environments, Cairngorm cubicles are vandal resistant and completely water proof. Manufactured from Compact Grade Laminate - a waterproof and hygienic product that has a high level of strength.

Cairngorm cubicles are supplied with heavy duty fittings which are through-bolted on site for increased stability.

Made to measure

Compact Grade Laminate (CGL)

Suited for use in shower areas

Heavy duty fittings

Available in an increased height configuration (See page 51)

www.washroomcubicles.co.uk



Indicator Face



Wide Base Cubicle Leg



Robust 'Single Action' Latch



Hidden Safety Hinge



A full-height design manufactured from **Compact Grade Laminate** framed and secured with full length channel fittings.

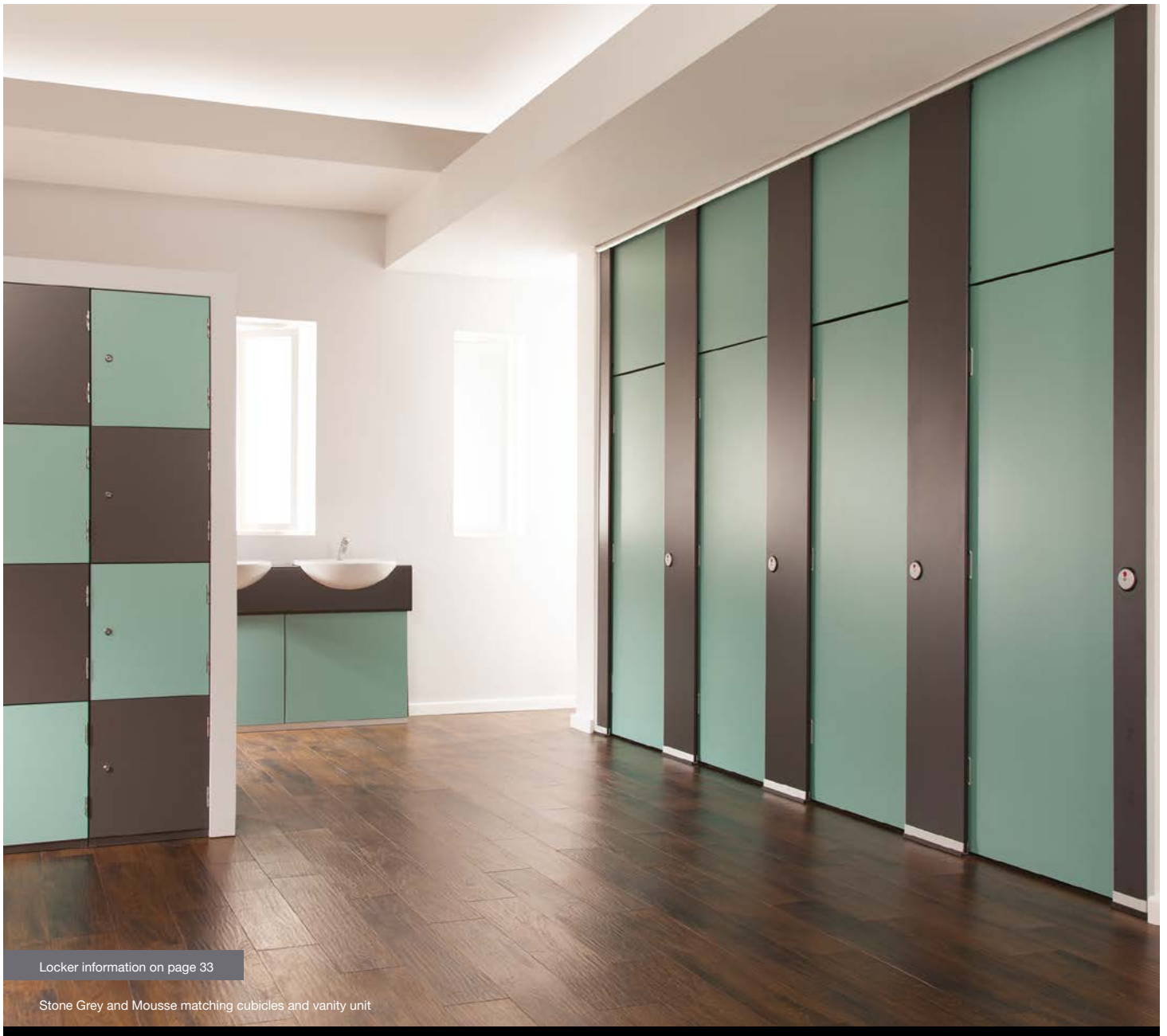

Locker information on page 33

Stone Grey and Mousse matching cubicles and vanity unit

Privacy

Technical: Page 48

For the ultimate in washroom privacy look no further. Durability combined with a functional, clean design make this full-height WC cubicle system a winning formula for modern commercial washrooms.

Made to measure

Full-height system

Compact Grade Laminate (CGL)

Heavy-duty fittings - no fixings visible from exterior

Wide colour choice



Indicator Face



Floor Channel



Robust 'Single Action' Latch



Hidden Safety Hinge

Cotswold cubicles are supplied with sub-assembled fittings saving you time and money on-site.

No fixings are visible from the exterior of the cubicle.





Compact Grade Laminate Panels - Oak

Cotswold

Specification: Page 49

A combination of style and durability, Cotswold is perfect for areas of high volume usage with a robust build quality proven to meet everyday demands.

- _____
- Made to measure
- _____
- Compact Grade Laminate (CGL)
- _____
- Fully framed system
- _____
- No fixings visible from exterior
- _____
- Wide colour choice
- _____



Indicator Face



Wide Base Cubicle Leg



Robust 'Single Action' Latch



Hidden Safety Hinge



The Brecon range is the most popular choice for junior schools.

Choose from square, arch, or reverse-curve door profiles, and from a range of vibrant colours – Blueberry, Mango and Dragon Fruit are popular options.



Blue Panels with Dragon Fruit Doors (Non-Standard Fittings Shown)



Brecon

Specification: Page 50

Combining creativity with added safety features, Brecon is the preferred choice of cubicle system for Junior school washrooms.

Made to measure

Melamine Faced Chipboard (MFC)

Anti-trap hinges and latches

Multi-coloured or SAA fittings

Bright selection of MFC colours



Indicator Face



Adjustable Cubicle Leg



Cubicle Latch



Hidden Safety Hinge



All the great features of the Brecon junior school cubicles, but with some added brawn.

Compact Grade Laminate (CGL) panels teamed up with durable fittings mean your cubicles should never be out-of-order.



Compact Grade Laminate (CGL) panels of Grigio Ferro partitions with Arancio Doors

Brecon CGL

Specification: Page 50

With all the playful options of the standard Brecon cubicle system, **Brecon CGL** is a real tough cookie suited for children's washrooms requiring a little extra muscle.

Made to measure

Compact Grade Laminate (CGL)

Anti-trap hinges and latches

Heavy duty fittings

Wide colour choice

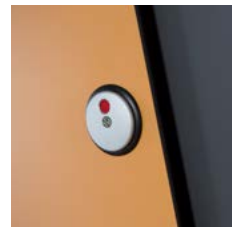

Indicator Face



Wide Base Cubicle Leg

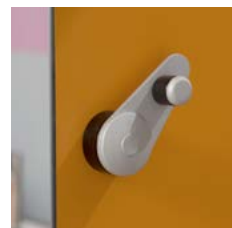

Robust 'Single Action' Latch



Hidden Safety Hinge



Sydney

Specification: Page 52

A lively and fun way to introduce young children to toilet cubicles and the washroom environment. Secure floor supports deliver a sturdy and safe cubicle system suited for any nursery / infant school washroom.

Made to measure

Melamine Faced Chipboard (MFC)

Overall height of 1500mm with 100mm floor clearance

Anti-trap hinges with magnetic door catch

Same colour selection as Brecon (MFC) range

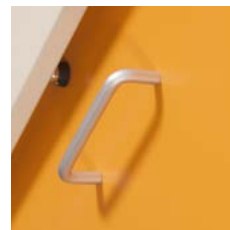

Child-Friendly Handle



Floor Supports



Magnetic Door Catch

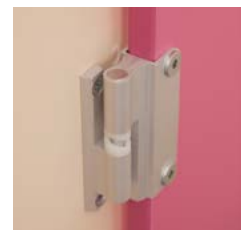

Hidden Safety Hinge



Sydney CGL

Specification: Page 52

Perfect for a EYFS or day nursery setting. All the child friendly design of Sydney, but with durable and water resistant panels. Slamming doors and splashed water are no trouble for these tough cubicles.

Made to measure

Compact Grade Laminate (CGL)

Overall height of 1500mm with 100mm floor clearance

Anti-trap hinges with magnetic door catch

Wide colour choice

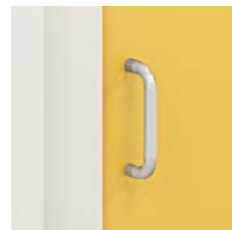

Child-Friendly Handle



Floor Supports



Unique Curved Design

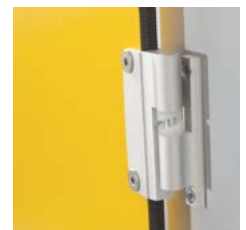

Hidden Safety Hinge



Vanity Units

Vanity Units are made to measure and available as either Inset (550mm deep) or Semi-Recessed (350mm deep) options. Overall vanity height is 850mm (standard) - this can be altered to suit your individual requirements.

Vanity tops are 20mm thick with a High Pressure Laminate (HPL) finish as standard. Under panels are constructed from high performance MFC as standard or CGL panels with a CGL vanity kit.

The new, unique design removes the need for a timber frame, saving you both time and money.

PLEASE NOTE:

Vanity Units are supplied in kit form for self-assembly.

Solid surface Vanity Units are available on request.



New



Banian Noirci top with Banian Bianchi under panels

CGL Vanity Units

The same specification as the standard vanity unit, but made from water-resistant and durable Compact Grade Laminate (CGL) panels. Also available in splash-resistant Compact Density Fibreboard (CDF) to match the cubicles. The ideal option for high usage areas.

Made to measure

CDF or CGL panel material

Choice of inset or semi-recessed designs

Unique design removes need for timber frame

Colour choice to match your cubicles



Semi-Recessed Vanity Unit



Curved Aluminium Front Edge



Matching Colour Choice



Made-to-Measure



Wall Panel Systems

Full-height wall panel systems can be supplied to match your cubicle colour configuration and material.

Panels are Melamine Faced Chipboard (MFC) as standard, with a protective PVC edging.

For areas prone to a wet environment, such as changing rooms, Cubicle Centre can supply CGL wall panel systems.

Panels come flat-packed, complete with all flash-gap material and suspension fitting components.

Overall system height varies according to your ceiling height.

See page 54 for specification details.



Timber frame supplied by other

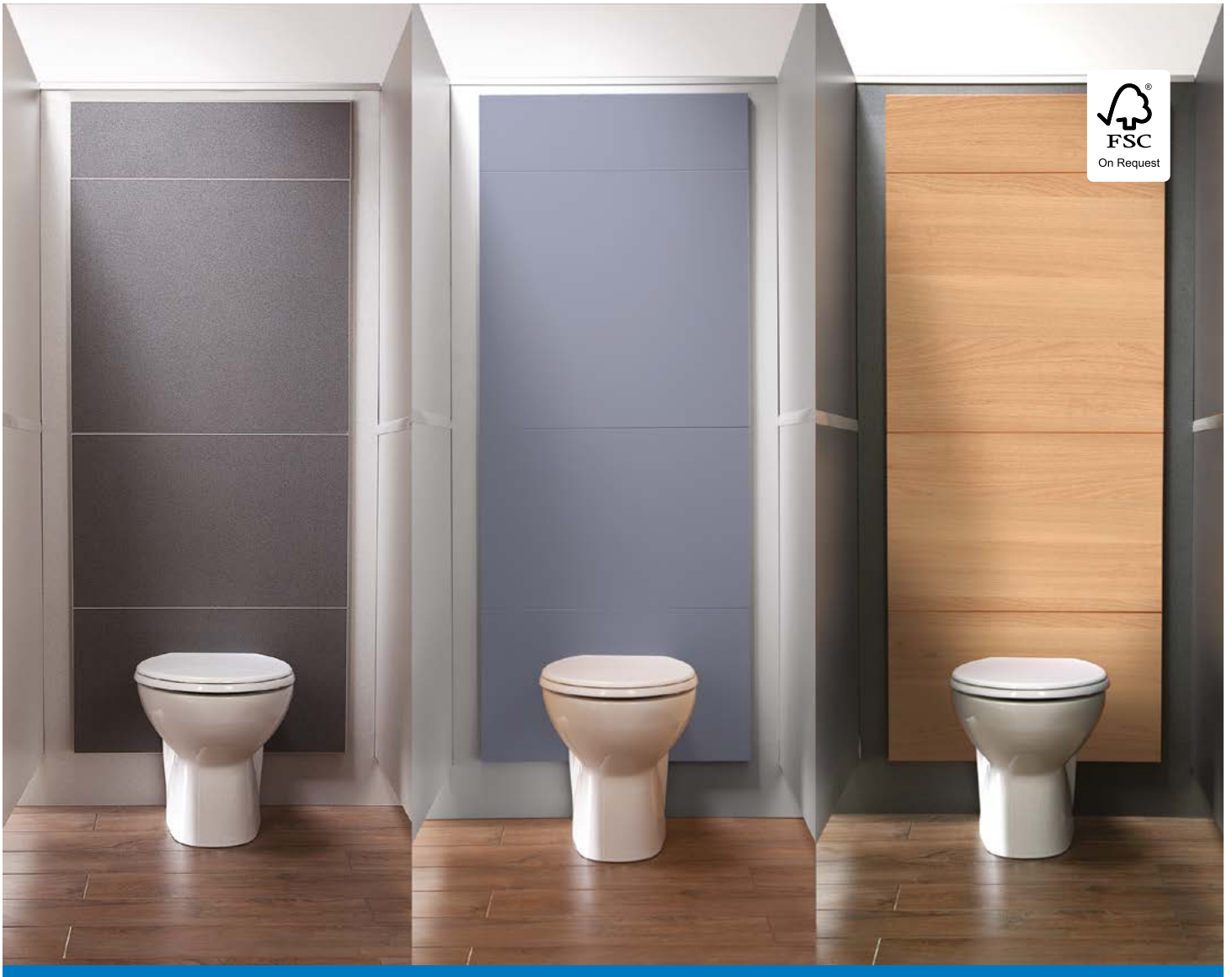

Pendle Panels

Simple to specify, delivered to you quickly and easily adjusted and installed on-site.

The Pendle washroom panel system has been developed for both urinal and WC panel configurations.

With an overall height to match Pendle cubicles (1950mm), this box packed panel system can be cut-to-size on site to fit various cubicle widths up to a max. of 1200mm.

Pendle Junior panels are available in Blueberry and Dragon Fruit.

Pendle products can be supplied as FSC certified on request.

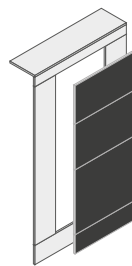

Grey

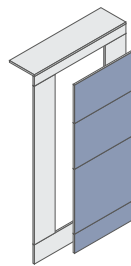

Smoke Blue

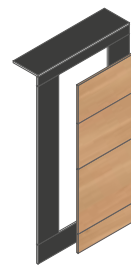

Woodgrain

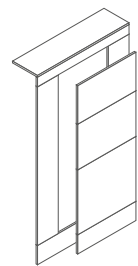

White

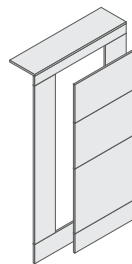

Plain Grey

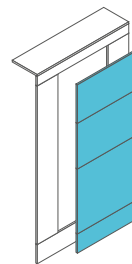

Blueberry

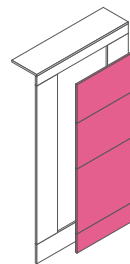

Dragon Fruit

Specification: page 55



Healthcare **IPS**

A complete IPS Panel System fully compliant with NHS Estate Guidelines and HBN 00-10 Part B panel specifications.

This panel only system allows for the reuse of existing sanitary ware but should new sanitary fittings be required, these can be supplied separately from the Plumbware.co.uk 'Healthcare' range.

Specification

Overall height: Variable to suit

Overall width: 800mm as standard

Panel System: 13mm Compact Grade Laminate panels

Boxed Unit: 20mm thick front panels with High Pressure Laminate finish

NOTE: Timber frame supplied by other.



Postformed edge detail available in HPL option

Healthcare IPS (HPL) Colour Options

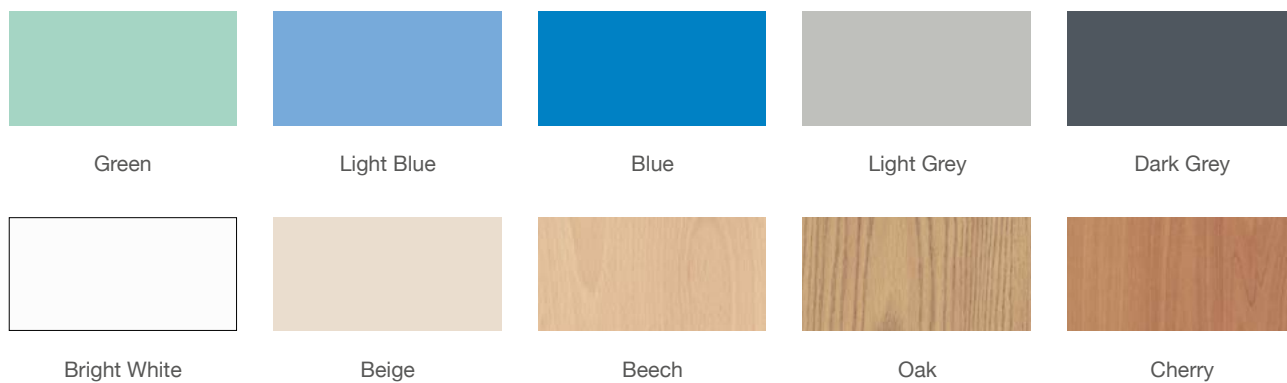

For CGL colour options visit: www.washroomcubicles.co.uk/compact-grade-laminate/

Healthcare IPS Configurations

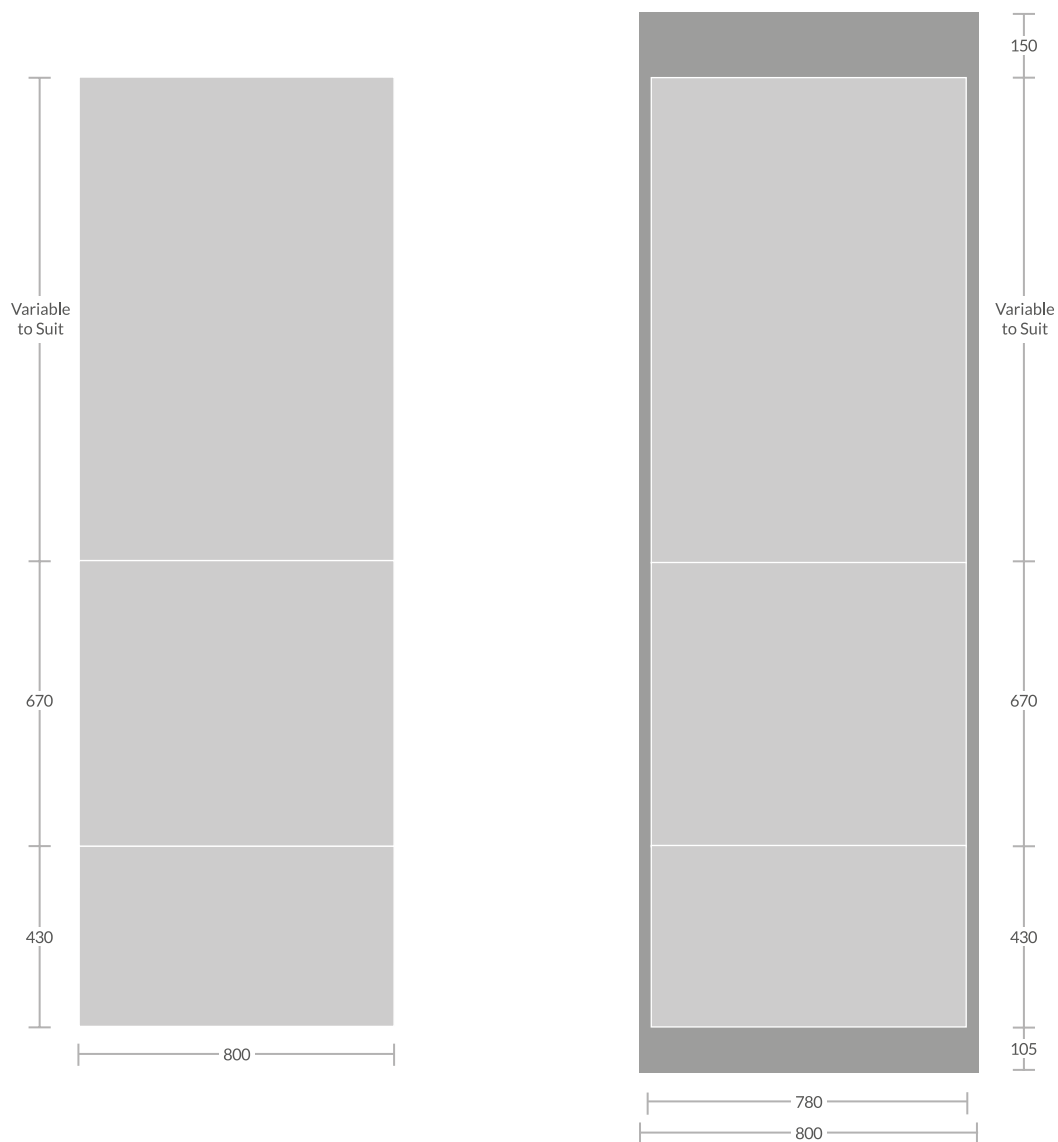

Panel System

Panels Compact Grade Laminate

Depth 13mm

Boxed Unit

Panels High Pressure Laminate

Depth 200mm standard + front panels



Cistern-Box Kits

Cistern-Box or 'half-height' kits are available as an alternative to the full height option.

Available in MFC, HPL, CDF and CGL, Cistern-Box Kits measure 1200mm (high) x 300mm (deep) as standard, and fit your internal cubicle width(s).

This product can also be manufactured to suit your individual site requirements, simply provide us with your measurements.

Timber frame supplied by others.



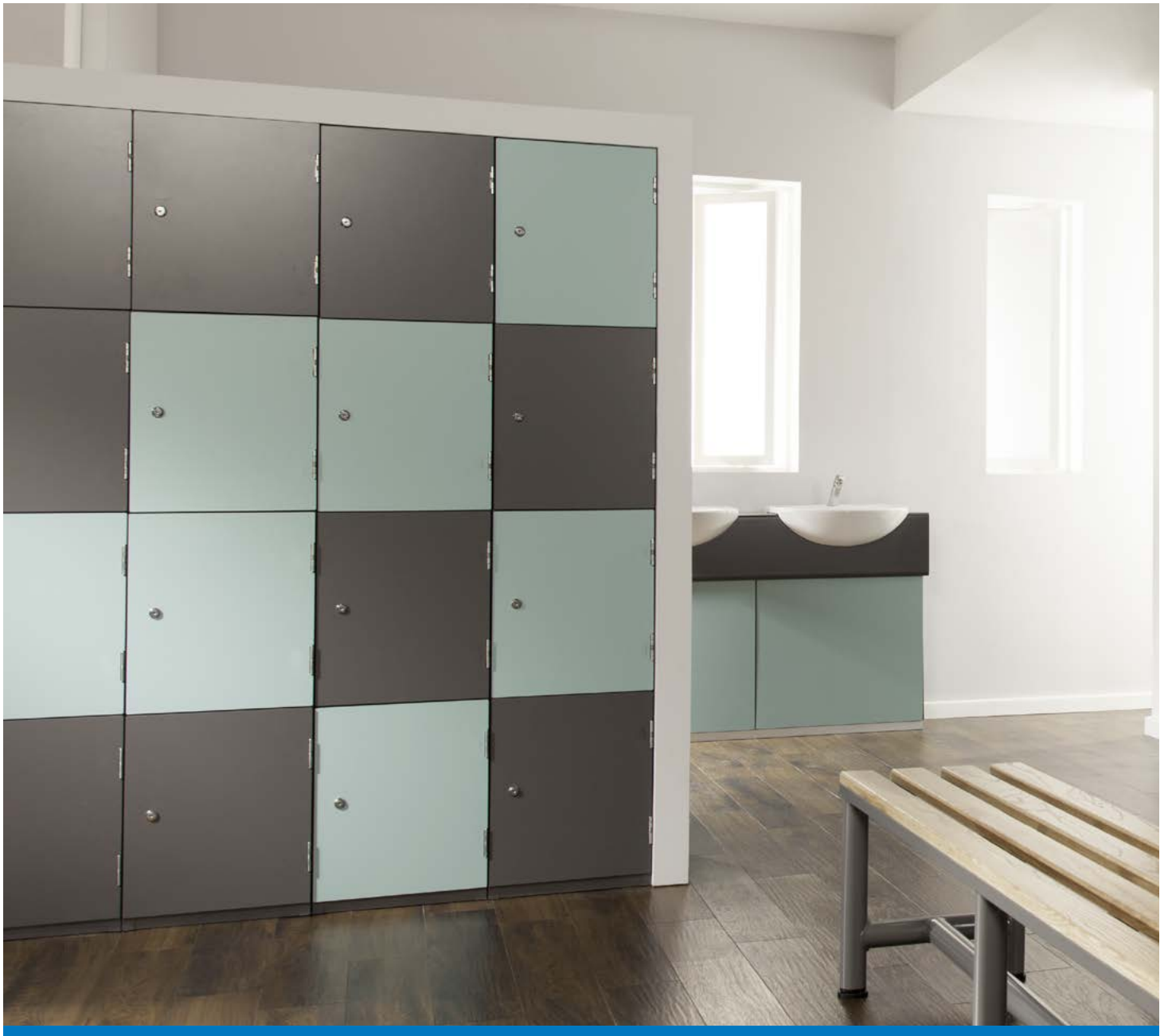

Lockers & Benches

For a complete changing room area, Cubicle Centre can now supply made to measure bench seating and locker systems.

Lockers are available in a variety of configurations to suit your requirements. There are a wide choice of colour options for the locker doors.

Various types of bench seating can be made to order.

Contact us on 01924 457600 to discuss your requirements and to obtain a quote.

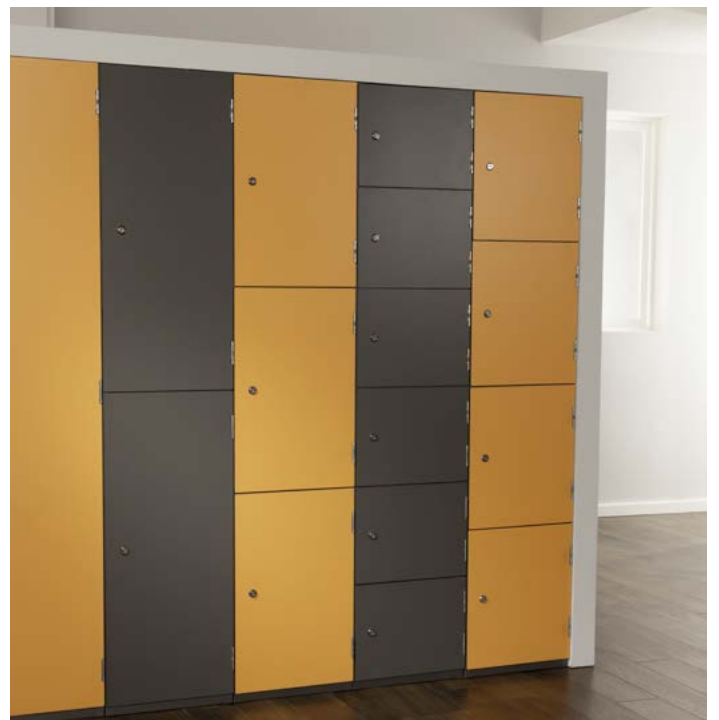

New



Black Sparkle Trevi Panel in a corner configuration

Trevi Panel

Trevi Panel offers a cost effective alternative to tiling a washroom. The panels are 11mm Moisture Resistant MDF which, when sealed, is perfect for wet locations.

Quick to install, more hygienic and very little maintenance required once fitted. The panels are adjustable on site to suit your requirements. Available in our range of standard and premium colours (www.washroomcubicles.co.uk/shower-panels/).

Orders are delivered with the following:

- Shower Panels measuring 1200mm x 2400mm
- Satin Silver Channels
- White Shower Seal Channel
- Adhesive and Silicone



Trevi Panel™ Shower Panel



Uniclass 1.4 L516
Uniclass 2015 Ss_25_25_45_25

NBS Create 25-85-45/120
Keynote K32/140

Manufacturer

Cubicle Centre
+44 (0)1924 457600
design@washroomcubicles.co.uk

Available Downloads

FITTING INSTRUCTIONS
.pdf format

Product reference Trevi Panel
Material Moisture Resistant MDF

Standard Panel Size
1200mm x 2400mm

Fittings

Satin Silver Internal Corner Channel
Satin Silver End Channel
Satin Silver "H" Connecting Channel
White PVC Seal Channel

Panel colour

Standard and Premium colours available. See link below

Framing

Satin Silver Channels

Colour

Standard & Premium options
www.washroomcubicles.co.uk/shower-panels/

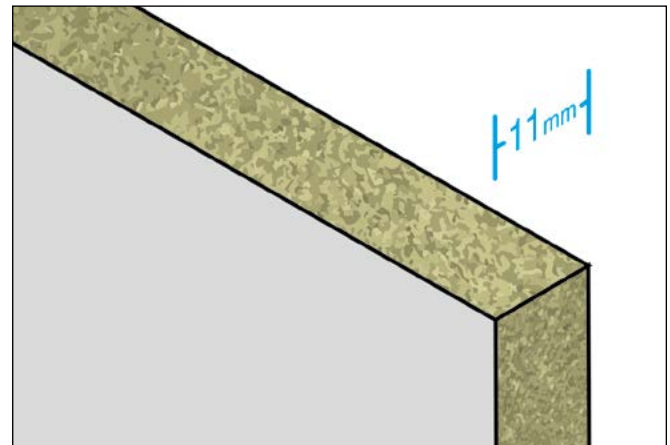

Moisture Resistant MDF

Moisture Resistant (MR) Medium-density fibreboard (MDF) is an engineered wood product made by breaking down hardwood or softwood residuals into wood fibres and combining it with wax and a resin binder, and forming panels by applying high temperature and pressure.

Once the edges are properly sealed the panels are ideal for wet room locations.

Corner Configuration

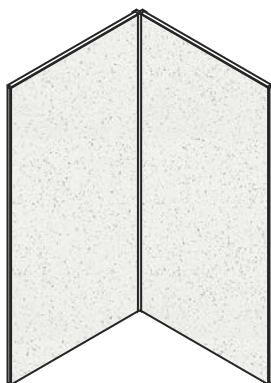

Enclosed Configuration

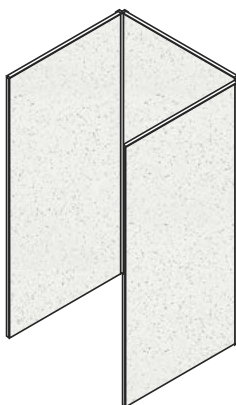

Return Configuration

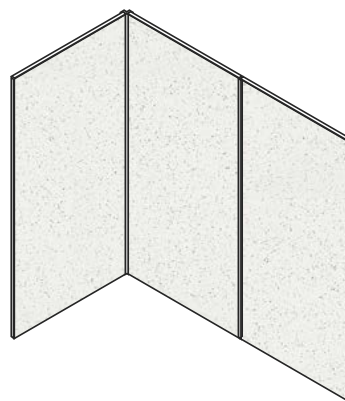

Panel Only



New



Banian Noirci vanity top with Morello Cherry Splashback

Acrylic Splashbacks

Acrylic splashbacks are beautiful and tough. The acrylic glass is 4mm thick with a back painted surface available in a range of colours. This gives a fantastic colour intensity and reflection through its surface, just like coloured glass.

Our acrylic panels are an affordable alternative to glass and ceramic tiles. The highly durable panels are 25 times more impact resistant than traditional glass. So it will not shatter.

It also has a high heat resistance of up to 100°C. The material is also 100% waterproof so ideal for the washroom environment.

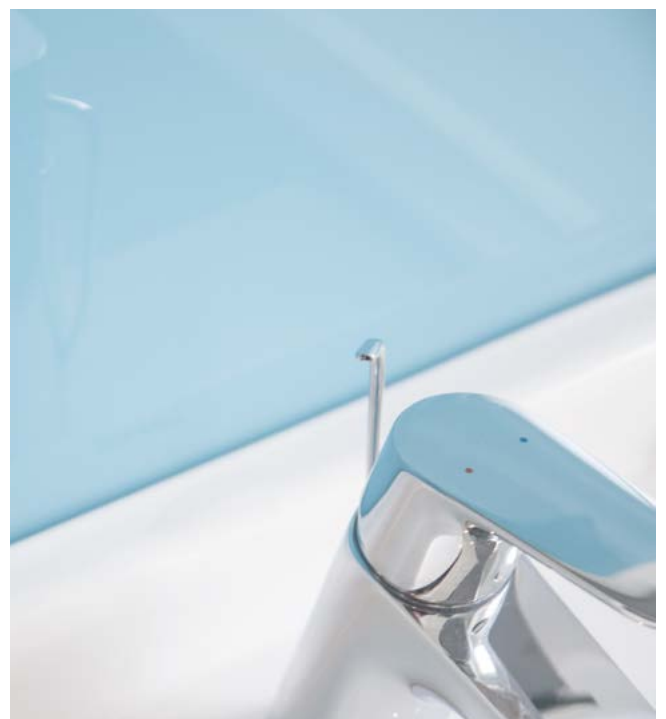

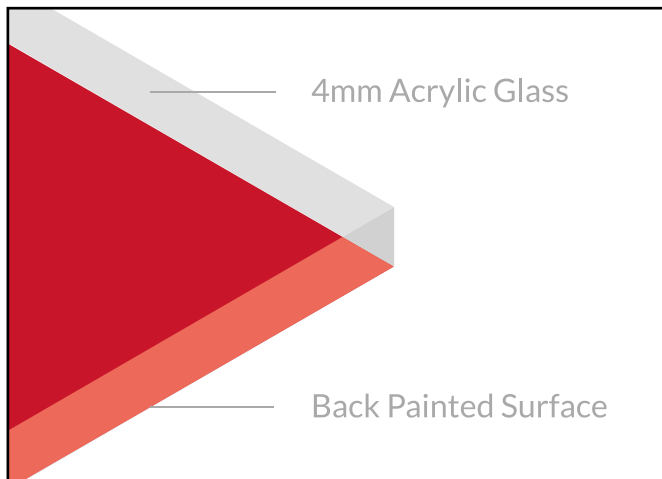

Acrylic Glass Summary

- Cost-effective glass alternative
- 100% waterproof
- Panels can be cut on site
- Scuffs can be polished away
- High heat resistance
- Will not shatter
- Less energy to produce than glass
- Material can be recycled
- Fantastic colour intensity
- Looks like traditional coloured glass

Acrylic Glass Colour Options



Toilet Cubicle Sizes (Universal Access Guidelines)

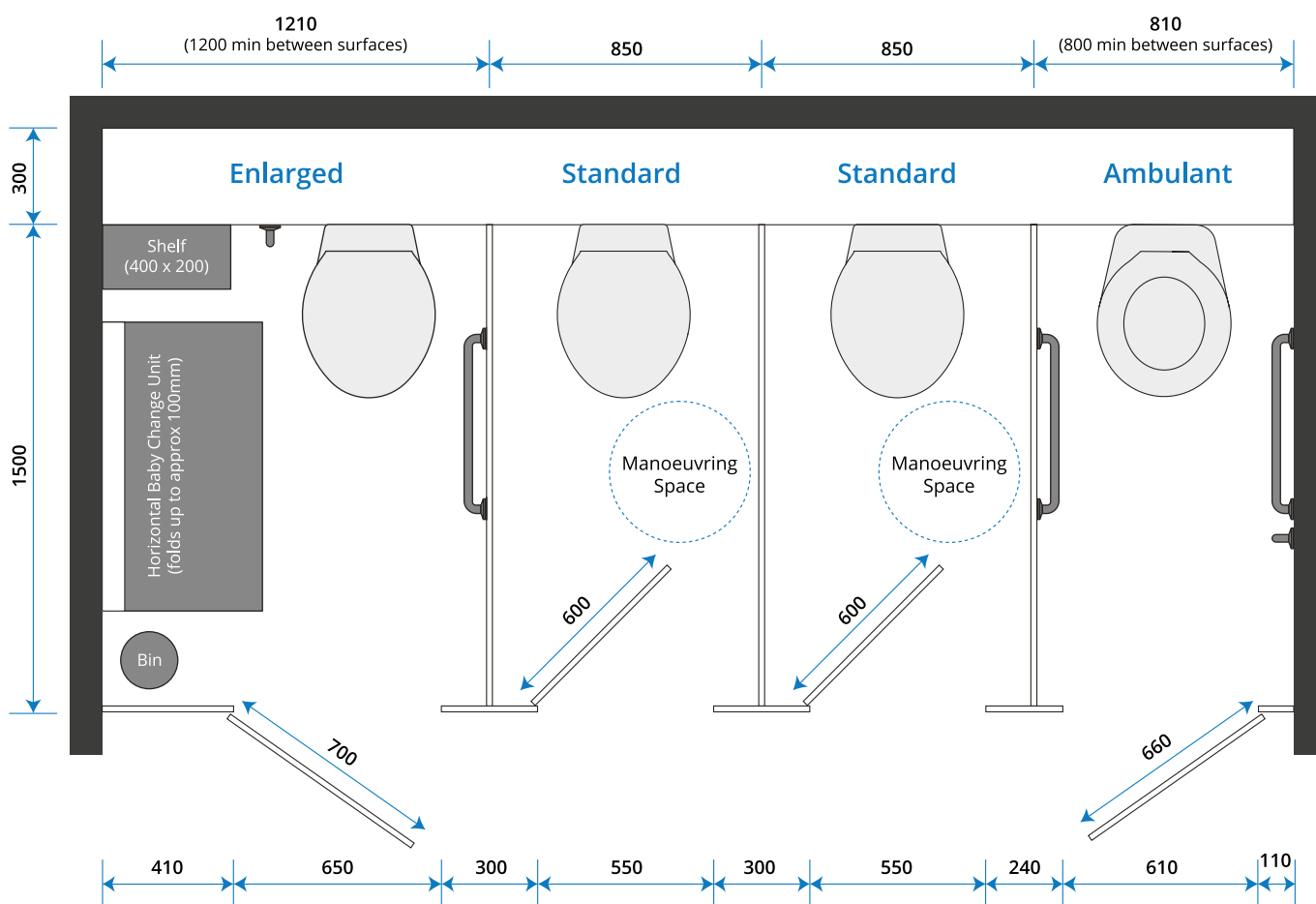

Enlarged WC Cubicles:

Where there are 4 or more cubicles in a washroom, one of these must be an enlarged cubicle.

Enlarged cubicles must be a minimum width of 1200mm and include an outward opening door.

A horizontal and vertical grab rail set is required around the WC.

Standard Toilet Cubicles:

All standard cubicles must now have a minimum of 450mm diameter manoeuvring space within the cubicle.

Indicator-bolts must be capable of being operated with a closed fist (single action) - and doors must allow for emergency access should the user collapse and become trapped in the cubicle.

Ambulant Disabled Cubicles:

Every same-sex washroom must have at least one wc cubicle that is suitable for the ambulant disabled.

If there is only one cubicle in the washroom this must be suitable for an ambulant disabled person.

The ambulant disabled cubicle must include an outward opening door.

Wheelchair Accessible Cubicle Dimensions

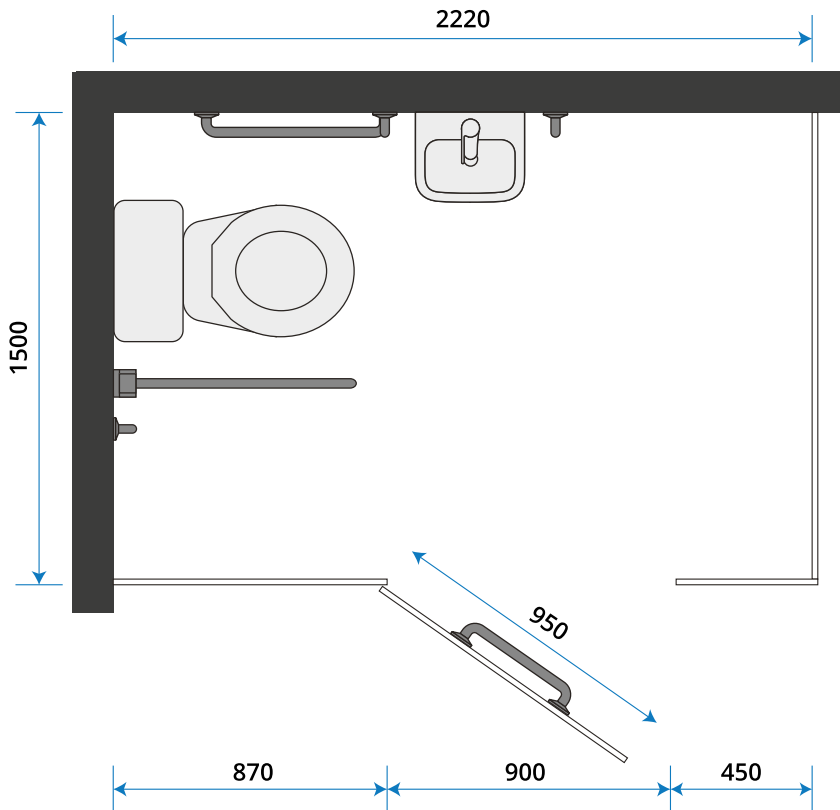

Wheelchair Accessible Cubicles:

The wheelchair accessible layout has been modified to accommodate an overall toilet cubicle length of 2220mm (previously 2000mm).

The door opening needs to be 900mm with a 950mm (wide) outward opening door.

Doc-M Packs are available to purchase online from:

plumbware.co.uk

Unisex Wheelchair Accessible Toilet Layout

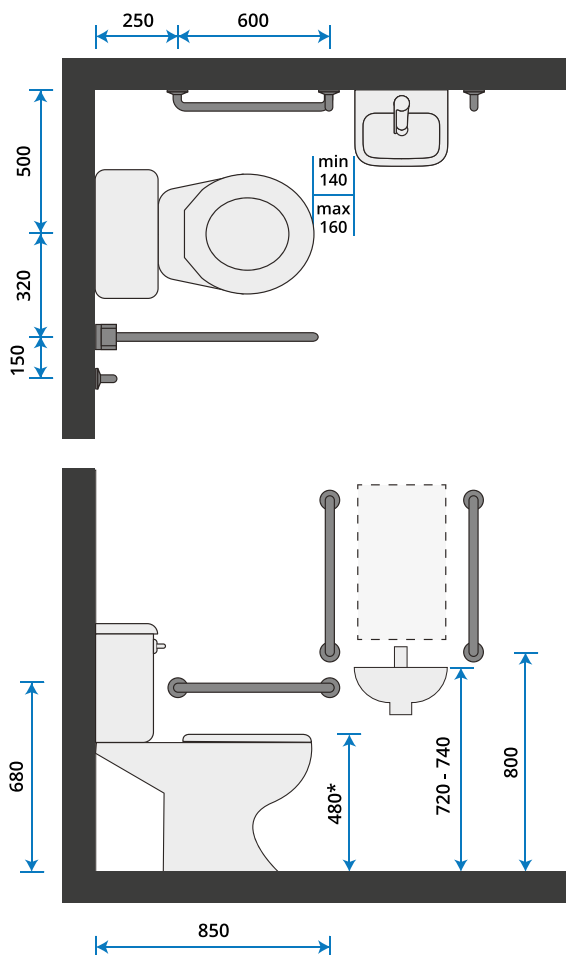

Ambulant Disabled Toilet Layout

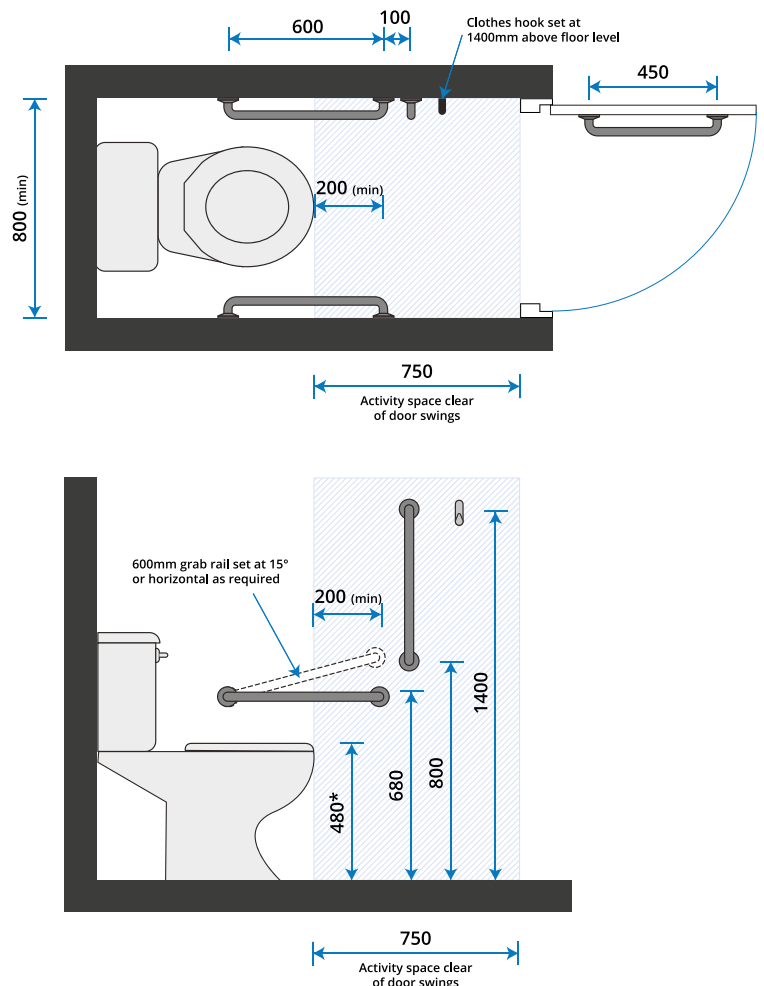

Pendle® Cubicle System



Uniclass 1.4 L2226
Uniclass 2015 Ss_25_12_60_60

NBS Create
Keynote

25-05-60/160
K32/120

Manufacturer

Cubicle Centre
+44 (0)1924 457600
design@washroomcubicles.co.uk

Available Downloads



How to Order

Pendle cubicles can be ordered quickly and easily online.
To place your order visit:
www.plumbware.co.uk

Product reference Pendle Cubicle System
Material Melamine Faced Chipboard

Pendle Dimensions
Every **DOOR** requires a **BOX A** | Every **PARTITION** requires a **BOX B**

Overall cubicle height
1950mm including a 150mm floor clearance

Partitions
Partition depth 1800mm (maximum)
Partition height 1800mm

Fittings
SAA: cubicle legs, heavy-duty hinges and cubicle latches. PVC header rail and channels.

Pendle System
Adjustments can be made to cubicles to suit site requirements by reducing doors and partitions on-site. The cut edges are protected by full-height door and wall channels.

Colours

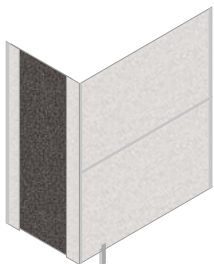

Grey



Woodgrain

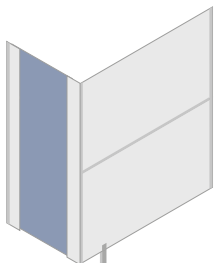

Smoke Blue

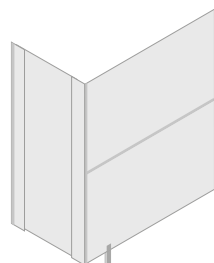

Plain Grey

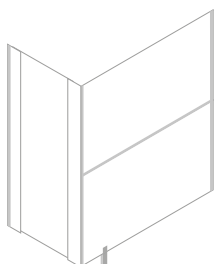

White

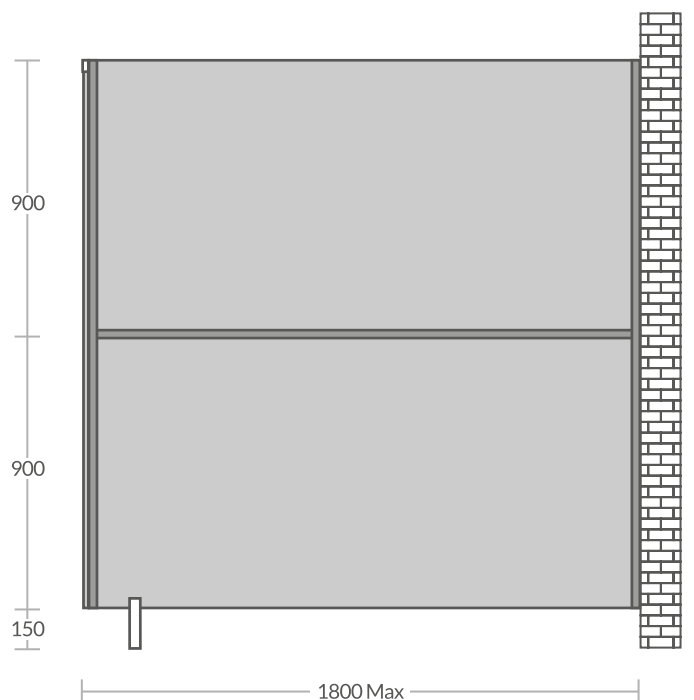
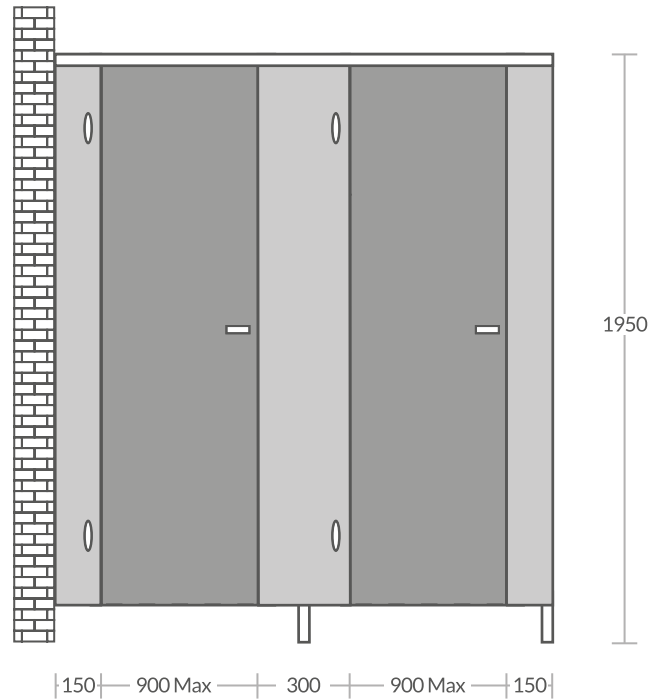

Pendle Junior[®] Cubicle System



Uniclass 1.4 L2226
Uniclass 2015 Ss_25_12_60_60

NBS Create 25-05-60/160
Keynote K32/120

Manufacturer

Cubicle Centre
+44 (0)1924 457600
design@washroomcubicles.co.uk

Available Downloads

CAD BLOCK
.dwg format

How to Order

Pendle cubicles can be ordered quickly and easily online.
To place your order visit:
www.plumbware.co.uk

Product reference Pendle Cubicle System
Material Melamine Faced Chipboard

Pendle Junior Dimensions
Every **DOOR** requires a **BOX A** | Every **PARTITION** requires a **BOX B**

Overall cubicle height
1950mm including a 150mm floor clearance

Partitions
Partition depth 1800mm (maximum)
Partition height 1800mm

Fittings
SAA: cubicle legs, heavy-duty hinges and cubicle latches. PVC header rail and channels.

Pendle System
Adjustments can be made to cubicles to suit site requirements by reducing doors and partitions on-site. The cut edges are protected by full-height door and wall channels.

Colours

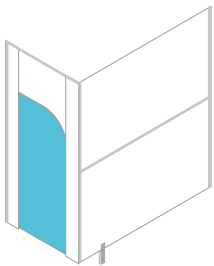

Blueberry

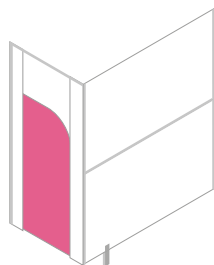

Dragon Fruit

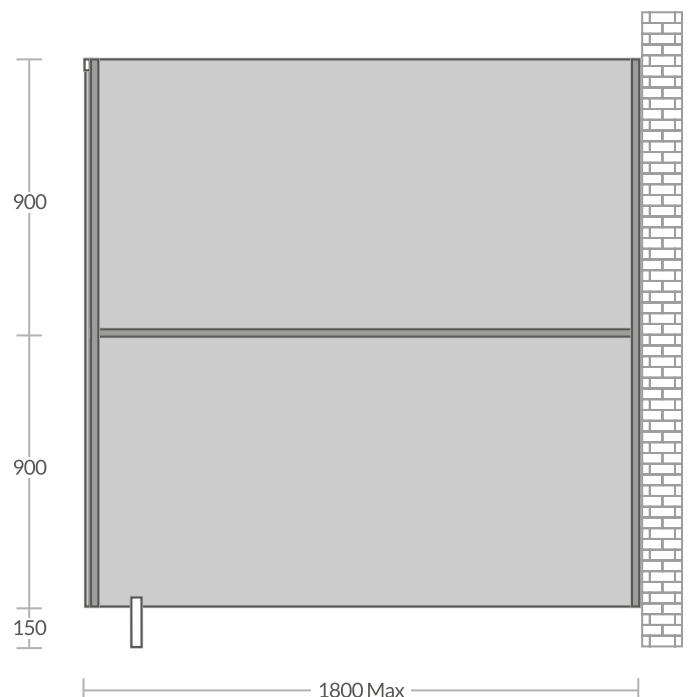
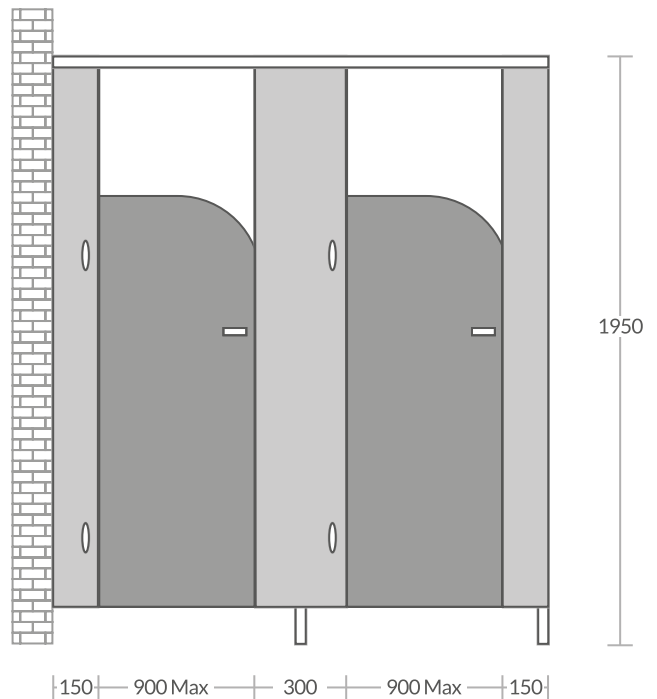

Pennine[®] Cubicle System



Uniclass 1.4 L2226
 Uniclass 2015 Ss_25_12_60_60

NBS Create 25-05-60/160
 Keynote K32/120

Manufacturer

Cubicle Centre
 +44 (0)1924 457600
design@washroomcubicles.co.uk

Available Downloads

CAD BLOCK .dwg format	BIM OBJECT .rfa format	NBS PLUS Create Specification
---------------------------------	----------------------------------	---

Product reference Pennine Cubicle System
Material Melamine Faced Chipboard

Overall cubicle height
 1955mm including a 155mm floor clearance

Partitions
 Partition depth 1500mm (standard)
 Up to 1800mm
 Partition height 1800mm
 Colour Speckled Light Grey, Plain Grey, White or Cream

Doors
 Colour As Partition colour

Fittings
 SAA: head-rail, brackets, cubicle legs, heavy-duty hinges and cubicle latches

Wall Panel System
 Height Not required, Full-height, Half-height
 Material Melamine Faced Chipboard
 Panel colour Speckled Light Grey, Plain Grey, White or Cream
 Flash colour As panel colour

Standard Pennine Dimensions

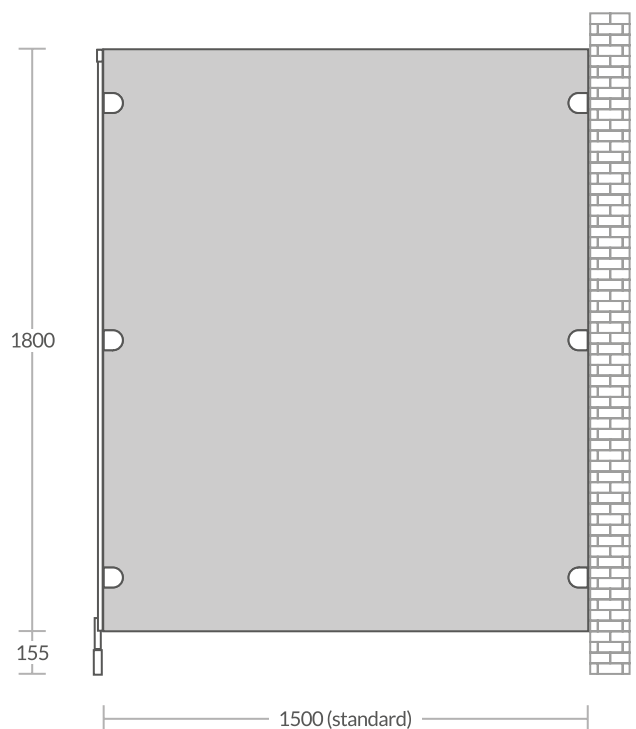
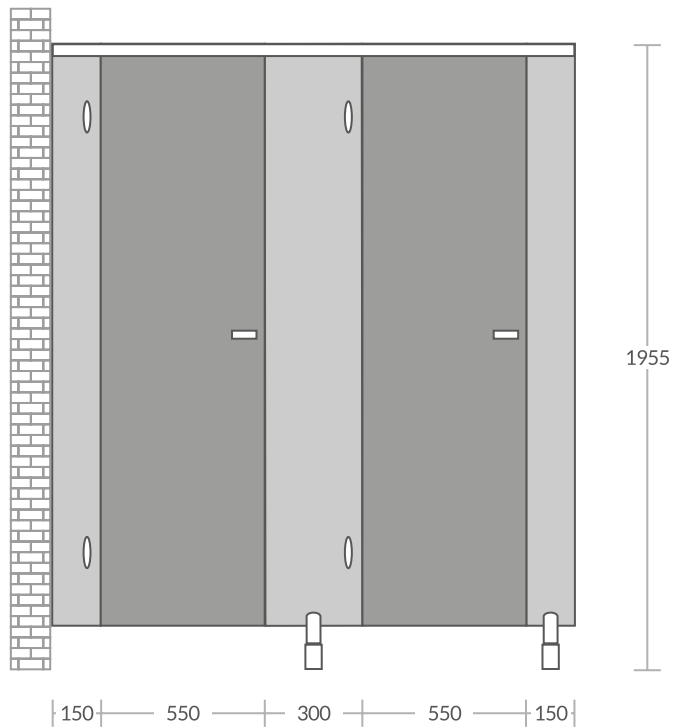

Malvern® Cubicle System



Uniclass 1.4 L2226
 Uniclass 2015 Ss_25_12_60_60

NBS Create 25-05-60/160
 Keynote K32/120

Manufacturer

Cubicle Centre
 +44 (0)1924 457600
design@washroomcubicles.co.uk

Available Downloads

CAD BLOCK .dwg format	BIM OBJECT .rfa format	NBS PLUS Create Specification
---------------------------------	----------------------------------	---

Product reference Malvern Cubicle System
Material Melamine Faced Chipboard

Overall cubicle height
 1955mm including a 155mm floor clearance

Partitions
 Partition depth 1500mm (standard)
 Up to 1800mm
 Partition height 1800mm
 Colour Speckled Light Grey, Plain Grey, White or Cream

Doors
 Colour See below

Fittings
 SAA: head-rail, brackets, adjustable cubicle legs, heavy-duty hinges and cubicle latches

Wall Panel System
 Height Not required, Full-height, Half-height
 Material Melamine Faced Chipboard
 Panel colour See below
 Flash colour See below

Colour
 Speckled Light Grey, Speckled Anthracite, Plain Grey, White, Cream, Blue, Red, Yellow

Standard Malvern Dimensions

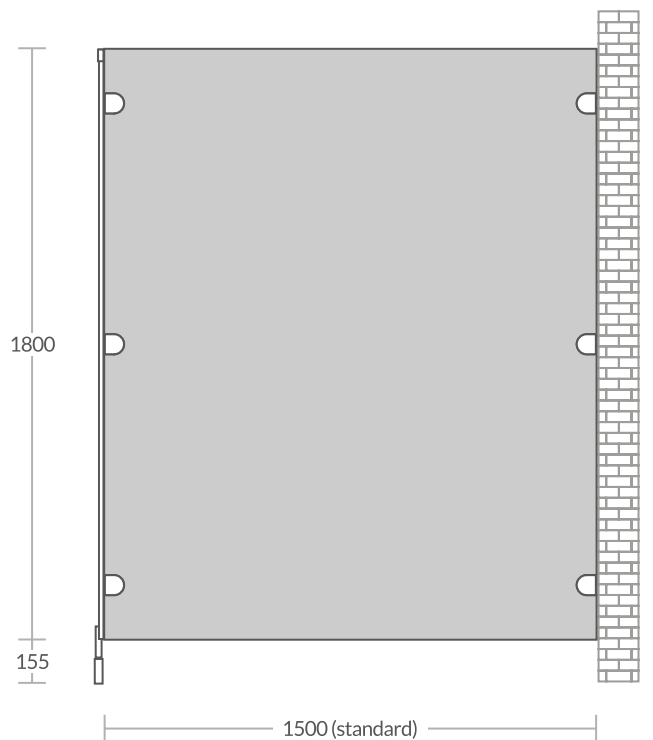
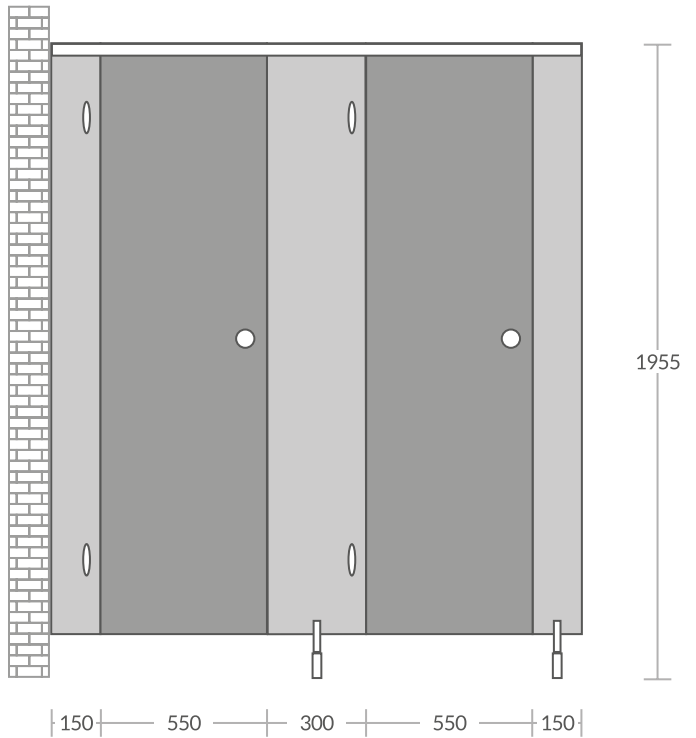

Malvern Plus[®] Cubicle System



Uniclass 1.4 L2226
 Uniclass 2015 Ss_25_12_60_60

NBS Create 25-05-60/160
 Keynote K32/120

Manufacturer

Cubicle Centre
 +44 (0)1924 457600
design@washroomcubicles.co.uk

Available Downloads

CAD BLOCK .dwg format	BIM OBJECT .rfa format	NBS PLUS Create Specification
---------------------------------	----------------------------------	---

Product reference Malvern Plus Cubicle System
Material Melamine Faced Chipboard

Overall cubicle height
 1955mm including a 155mm floor clearance

Partitions

Partition depth 1500mm (standard)
 Up to 1800mm
 Partition height 1800mm
 Colour See below

Doors

Colour See below

Fittings

SAA: head-rail, brackets, adjustable cubicle legs, heavy-duty hinges and cubicle latches

Wall Panel System

Height Not required, Full-height, Half-height
 Material Melamine Faced Chipboard
 Panel colour See below
 Flash colour See below

Colour

Full colour range
www.washroomcubicles.co.uk/malvern-plus-colours/

Increased Height

[Available in an increased height configuration \(See page 51\)](#)

Standard Malvern Plus Dimensions

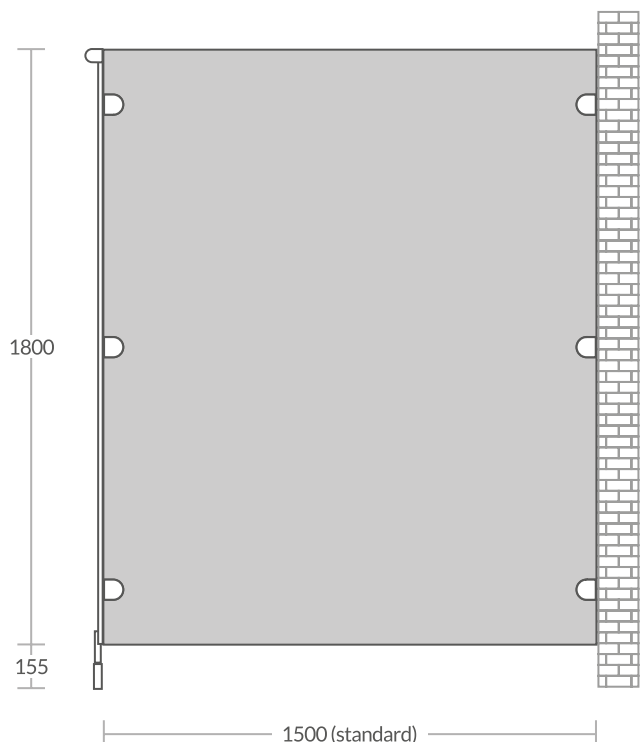
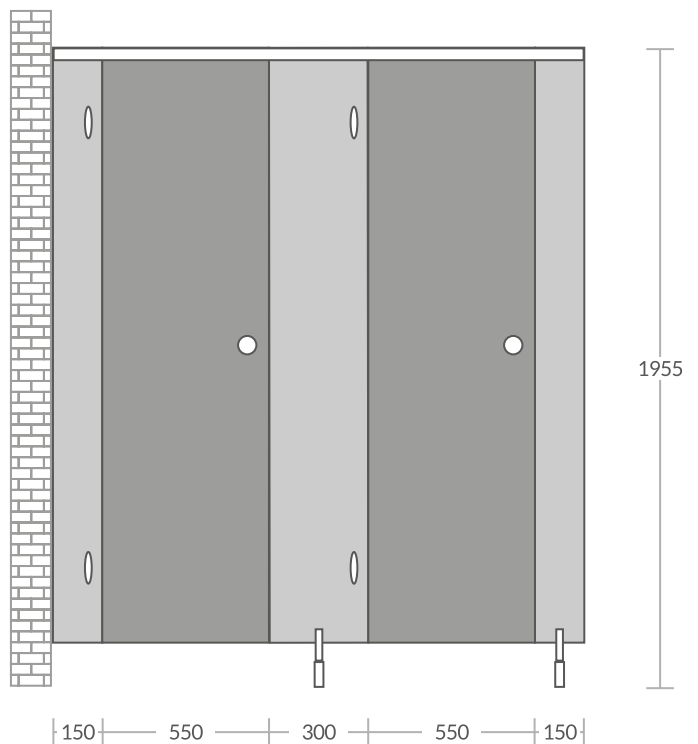

Grampian[®] Cubicle System



Uniclass 1.4 L2226
Uniclass 2015 Ss_25_12_60_60

NBS Create
Keynote

25-05-60/160
K32/120

Manufacturer

Cubicle Centre
+44 (0)1924 457600

design@washroomcubicles.co.uk

Available Downloads

CAD BLOCK
.dwg format

BIM OBJECT
.rfa format

NBS PLUS
Create Specification

Product reference Grampian Cubicle System
Material High Pressure Laminate

Overall cubicle height
1955mm including a 155mm floor clearance

Partitions

Partition depth 1500mm (standard)
Up to 1500mm
Partition height 1800mm
Colour See below

Doors

Colour See below

Fittings

SAA: head-rail, brackets, adjustable cubicle legs, heavy-duty hinges and cubicle latches

Wall Panel System

Height Not required, Full-height, Half-height
Material High Pressure Laminate
Panel colour See below
Flash colour See below

Colour

White, Bright White, Cream, Light Grey, Mid Grey, Dark Grey, Black, Speckled Light Grey, Speckled Anthracite, Lime Green, Blue, Dark Blue, Red, Beech, Maple

Non-standard

www.washroomcubicles.co.uk/high-pressure-laminate/

Increased Height

[Available in an increased height configuration \(See page 51\)](#)

Standard Grampian Dimensions

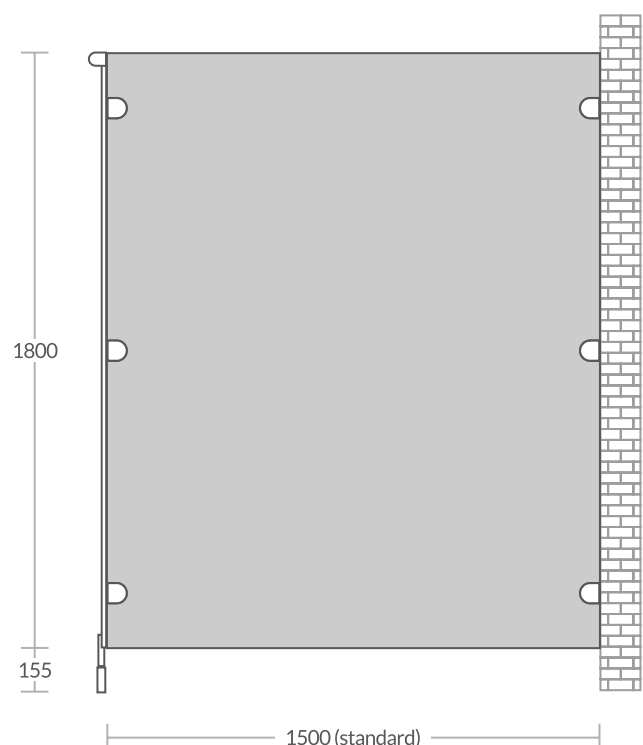
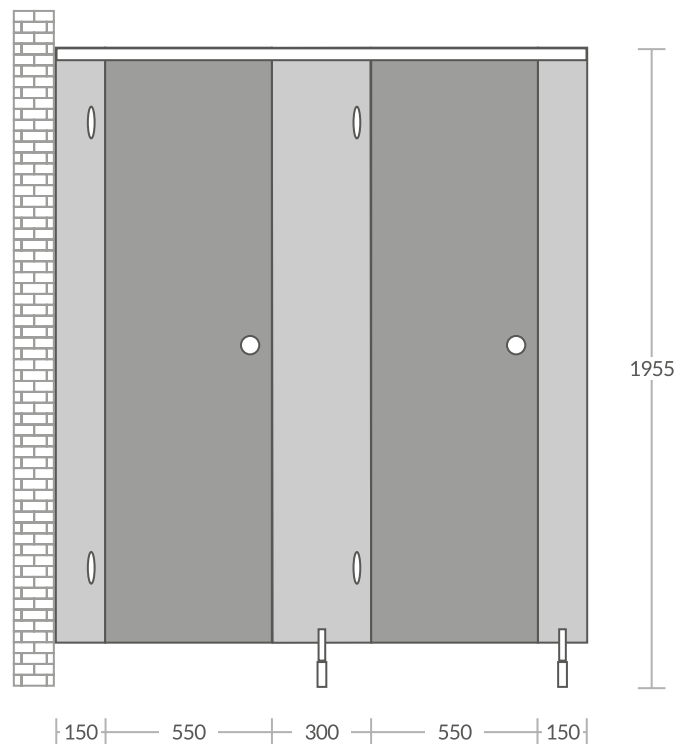

Cambrian™ Cubicle System



Uniclass 1.4 L2226
 Uniclass 2015 Ss_25_12_60_60

NBS Create 25-05-60/160
 Keynote K32/120

Manufacturer

Cubicle Centre
 +44 (0)1924 457600
design@washroomcubicles.co.uk

Available Downloads

CAD BLOCK
 .dwg format

NBS PLUS
 Create Specification

Product reference Cambrian Cubicle System
Material Compact Density Fibreboard

Overall cubicle height
 1955mm including a 155mm floor clearance

Partitions

Partition depth 1500mm (standard)
 Up to 1800mm
 Partition height 1800mm
 Colour See below

Doors

Colour See below

Fittings

SAA: head-rail, brackets, wide-base cubicle legs, heavy-duty hinges and cubicle latches

Wall Panel System

Height Not required, Full-height, Half-height
 Material Compact Density Fibreboard
 Panel colour See below
 Flash colour See below

Colour

Full colour range
www.washroomcubicles.co.uk/compact-density-fibreboard/

Increased Height

[Available in an increased height configuration \(See page 51\)](#)

Standard Cambrian Dimensions

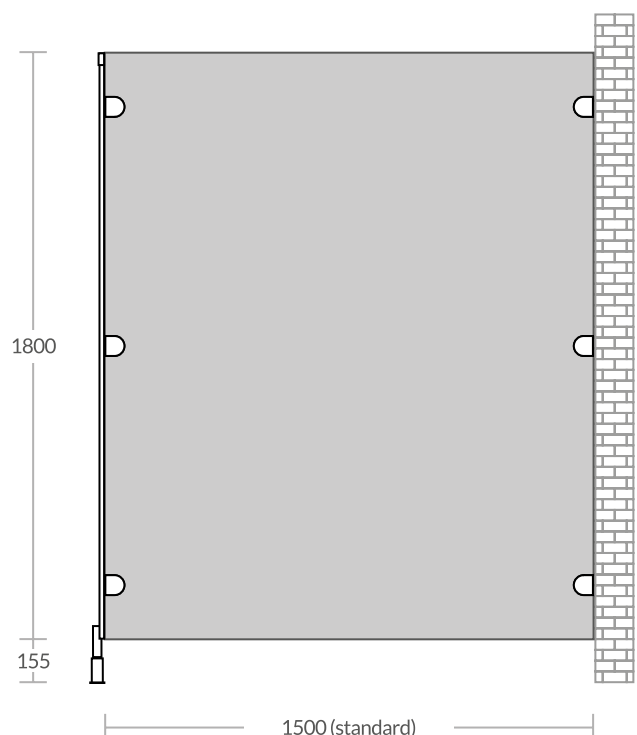
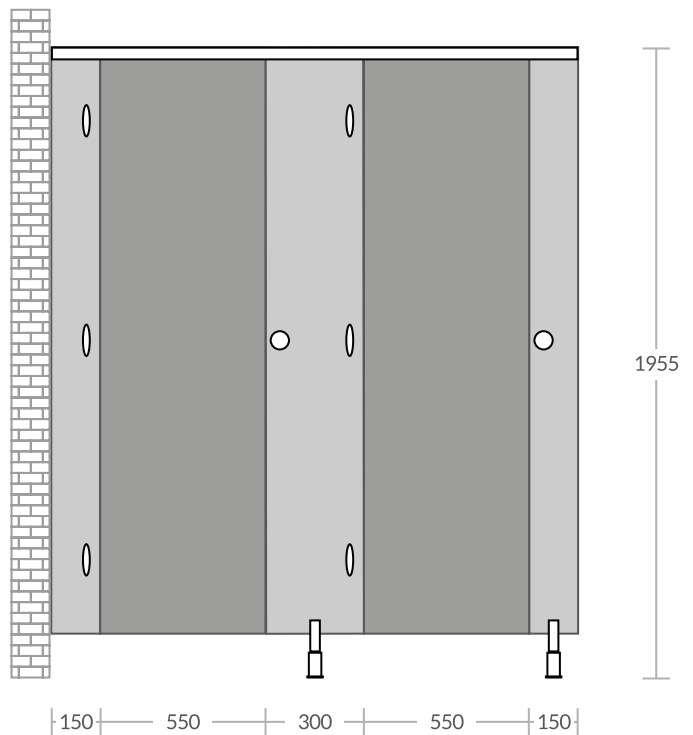

Cairngorm® Cubicle System



Uniclass 1.4 L2226
Uniclass 2015 Ss_25_12_60_60

NBS Create 25-05-60/160
Keynote K32/120

Manufacturer

Cubicle Centre
+44 (0)1924 457600
design@washroomcubicles.co.uk

Available Downloads

CAD BLOCK
.dwg format

BIM OBJECT
.rfa format

NBS PLUS
Create Specification

Product reference Cairngorm Cubicle System

Material Compact Grade Laminate

Overall cubicle height

1955mm including a 155mm floor clearance

Partitions

Partition depth 1500mm (standard)
Up to 1800mm

Partition height 1800mm

Colour See below

Doors

Colour See below

Fittings

SAA: head-rail, brackets, wide-base cubicle legs, heavy-duty hinges and cubicle latches

Wall Panel System

Height Not required, Full-height, Half-height

Material Compact Grade Laminate

Panel colour See below

Flash colour See below

Colour

Full colour range

www.washroomcubicles.co.uk/compact-grade-laminate/

Increased Height

[Available in an increased height configuration \(See page 51\)](#)

Standard Cairngorm Dimensions

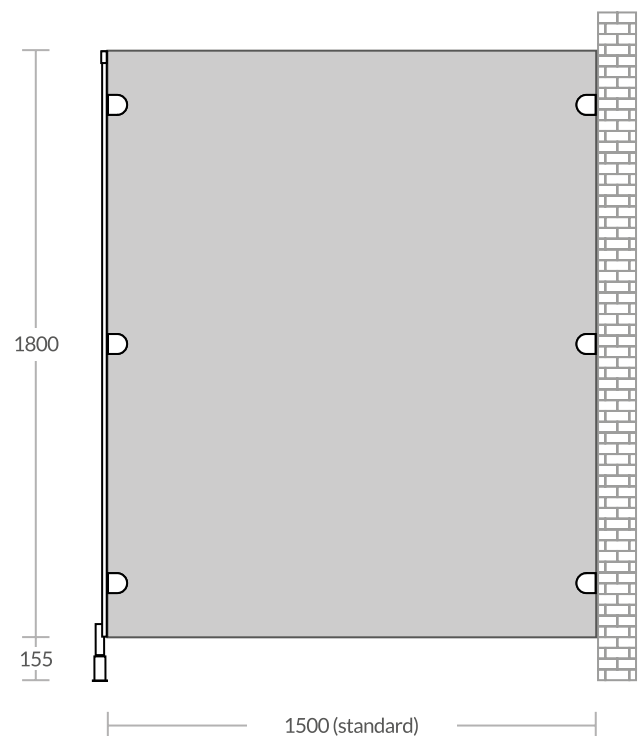
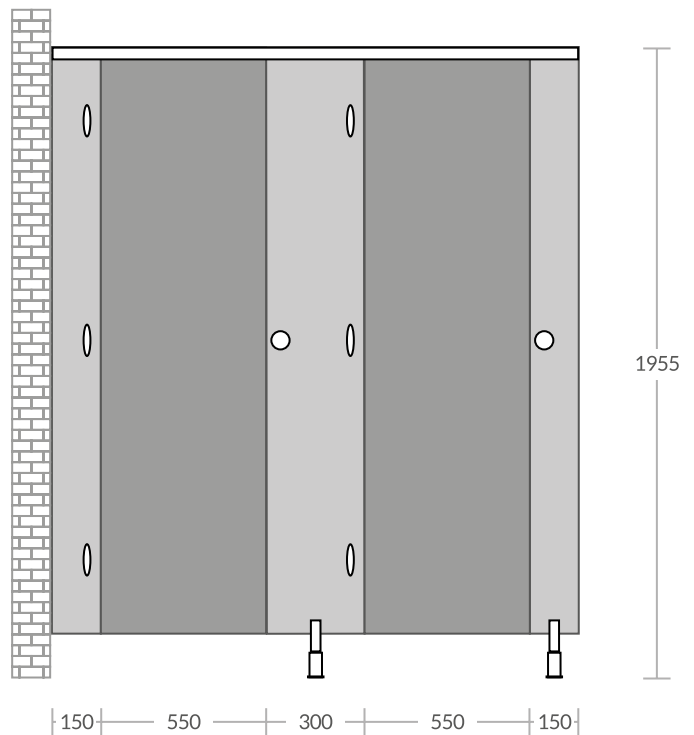

Privacy™ Cubicle System



Uniclass 1.4 L2226 NBS Create 25-05-60/130
 Uniclass 2015 Ss_25_12_60_30 Keynote K32/112

Manufacturer

Cubicle Centre
 +44 (0)1924 457600
design@washroomcubicles.co.uk

Available Downloads

CAD BLOCK .dwg format	BIM OBJECT .rfa format	NBS PLUS Create Specification
---------------------------------	----------------------------------	---

Product reference Privacy Cubicle System
Material Compact Grade Laminate

Overall cubicle height
 2600mm (max) including a 15mm floor clearance at door

Partitions
 Partition depth 1500mm (standard)
 Up to 2000mm
 Partition height Up to 2600mm
 Colour See below

Doors
 Colour See below

Fittings
 SAA: head-rail, wall and partition channels, heavy-duty hinges and cubicle latches

Wall Panel System
 Height Not required, Full-height, Half-height
 Material Compact Grade Laminate
 Panel colour See below
 Flash colour See below

Colour
 Full colour range
www.washroomcubicles.co.uk/privacy-cubicle-colours/

Standard Privacy Dimensions

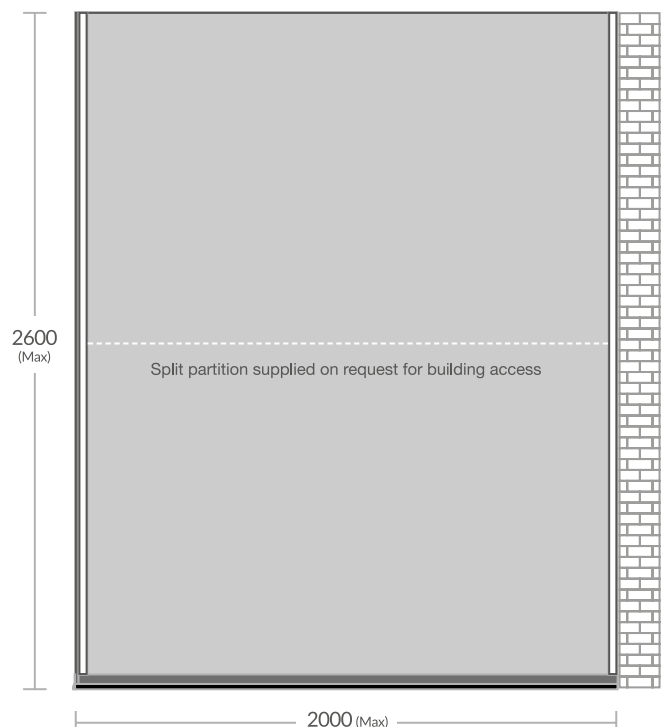
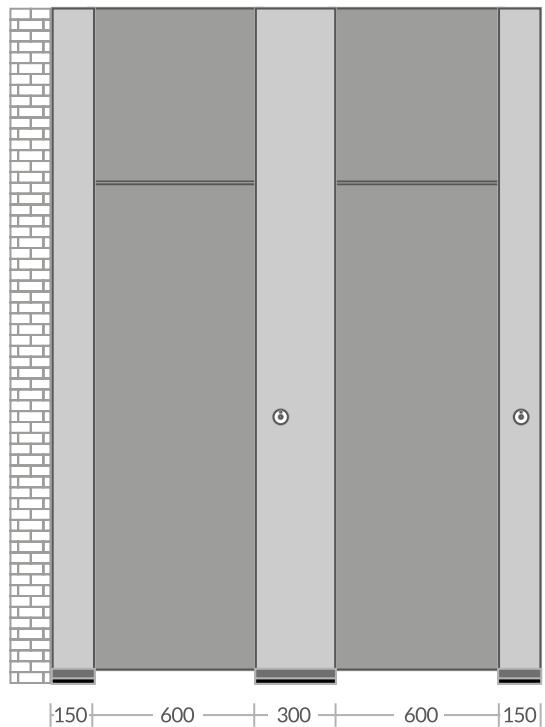

Cotswold® Cubicle System



Uniclass 1.4 L2226
 Uniclass 2015 Ss_25_12_60_30

NBS Create
 Keynote

25-05-60/130
 K32/112

Manufacturer

Cubicle Centre
 +44 (0)1924 457600
design@washroomcubicles.co.uk

Available Downloads

CAD BLOCK .dwg format	BIM OBJECT .rfa format	NBS PLUS Create Specification
---------------------------------	----------------------------------	---

Product reference Cotswold Cubicle System
Material Compact Grade Laminate (standard)
 Melamine Faced Chipboard

Overall cubicle height
 1980mm including a 150mm floor clearance

Partitions

Partition depth 1500mm (standard)
 Up to 1800mm
 Partition height 1800mm
 Colour See below

Doors

Colour See below

Fittings

Pilasters at 112mm (end) and 200mm (middle) as site ready sub-assemblies; hinges, leg supports, latches and wall channels (powder-coated finish)

Wall Panel System

Height Not required, Full-height, Half-height
 Material Compact Grade Laminate (standard)
 Melamine Faced Chipboard
 Panel colour See below
 Flash colour See below

Colour

Full colour range
www.washroomcubicles.co.uk/compact-grade-laminate/
www.washroomcubicles.co.uk/melamine-faced-chipboard/

Standard Cotswold Dimensions

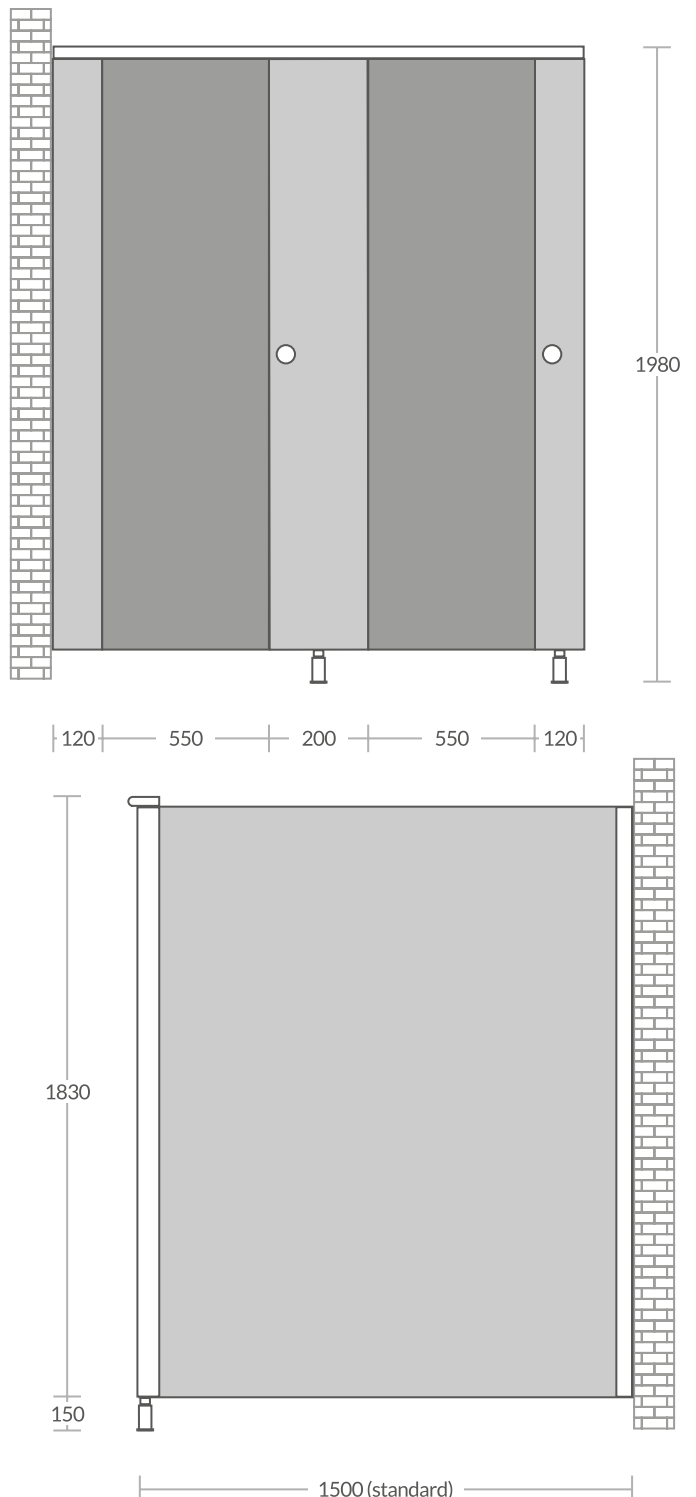

Brecon[®] Cubicle System



Uniclass 1.4 L2226
Uniclass 2015 Ss_25_12_60_60

NBS Create 25-05-60/160
Keynote K32/120

Manufacturer

Cubicle Centre
+44 (0)1924 457600

design@washroomcubicles.co.uk

Available Downloads

CAD BLOCK
.dwg format

BIM OBJECT
.rfa format

NBS PLUS
Create Specification

Product reference Brecon Cubicle System
Material Melamine Faced Chipboard

Overall cubicle height
1955mm including a 155mm floor clearance

Partitions

Partition depth 1500mm (standard)
Up to 1800mm
Partition height 1800mm (standard)
1200mm, 1350mm, 1500mm shaped
partition at extra cost
Colour See below

Doors

Door profile Arch,
Square or
Reverse Curve
w/ 300mm drop



Door height 1200mm (Arch or Square only),
1350mm, 1500mm
Colour See below
Decorative vinyl Happy Everything, Space Adventure,
Colourful Chameleons, Ocean View

Standard Brecon Dimensions

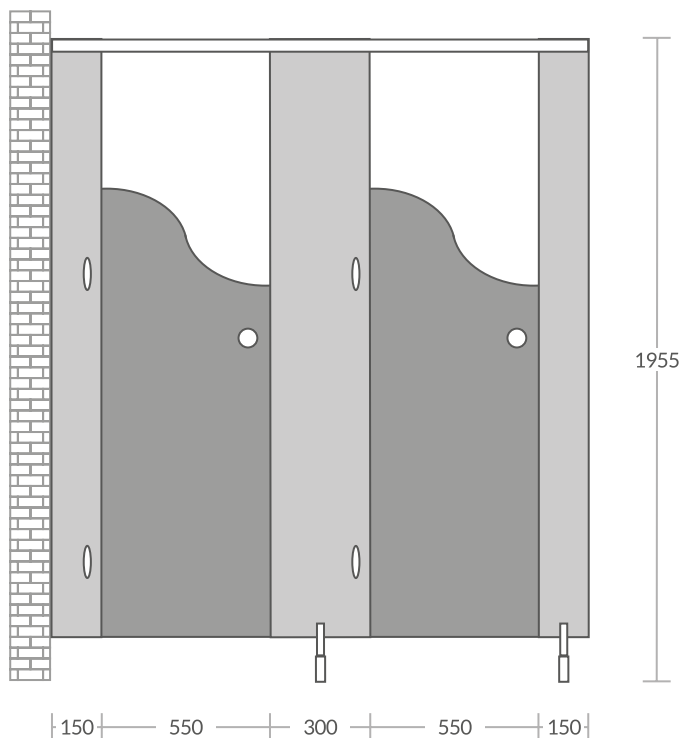

Fittings

SAA or Powder-coated (multi-coloured): head-rail, brackets, adjustable cubicle legs, heavy-duty hinges and cubicle latches

Wall Panel System

Height Not required, Full-height, Half-height
Material Melamine Faced Chipboard
Panel colour See below
Flash colour See below

Colour

Blue, Red, Yellow, Green, White, Cream, Plain Grey, Stone Grey, Blueberry, Kiwifruit, Mango, Dragon Fruit

Notes

[Brecon is available in CGL @ extra cost](#)

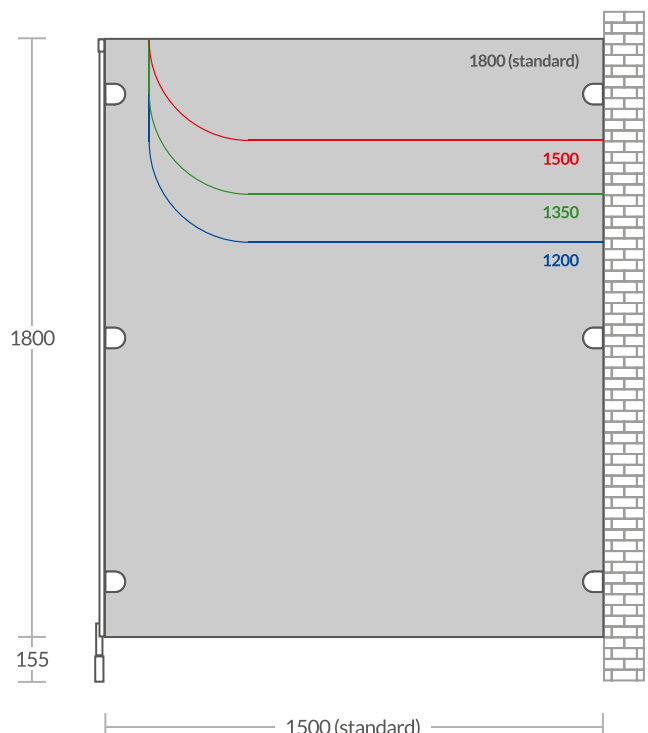

Increased Height WC Cubicles



Uniclass 1.4 L2226 NBS Create 25-05-60/160
 Uniclass 2015 Ss_25_12_60_60 Keynote K32/120

Manufacturer

Cubicle Centre
 +44 (0)1924 457600
design@washroomcubicles.co.uk

Product reference and Material

Increased Height WC Cubicles:
 Malvern Plus - Melamine Faced Chipboard
 Grampian - High Pressure Laminate
 Cairngorm - Compact Grade Laminate
 Cambrian - Compact Density Fibreboard

Overall cubicle height

2100mm including a 100mm floor clearance

Partitions

Partition depth 1500mm (standard)
 Up to 1800mm
 Partition height 2000mm
 Colour See below

Doors

Colour See below

Fittings

SAA: head-rail, brackets, partition pedestals, heavy-duty hinges and cubicle latches

Wall Panel System

Height Not required, Full-height, Half-height
 Material Melamine Faced Chipboard
 High Pressure Laminate
 Compact Grade Laminate
 Compact Density Fibreboard
 Panel colour See below
 Flash colour See below

Colour

Full colour range
www.washroomcubicles.co.uk/increased-height-cubicles/

Increased Height WC Dimensions

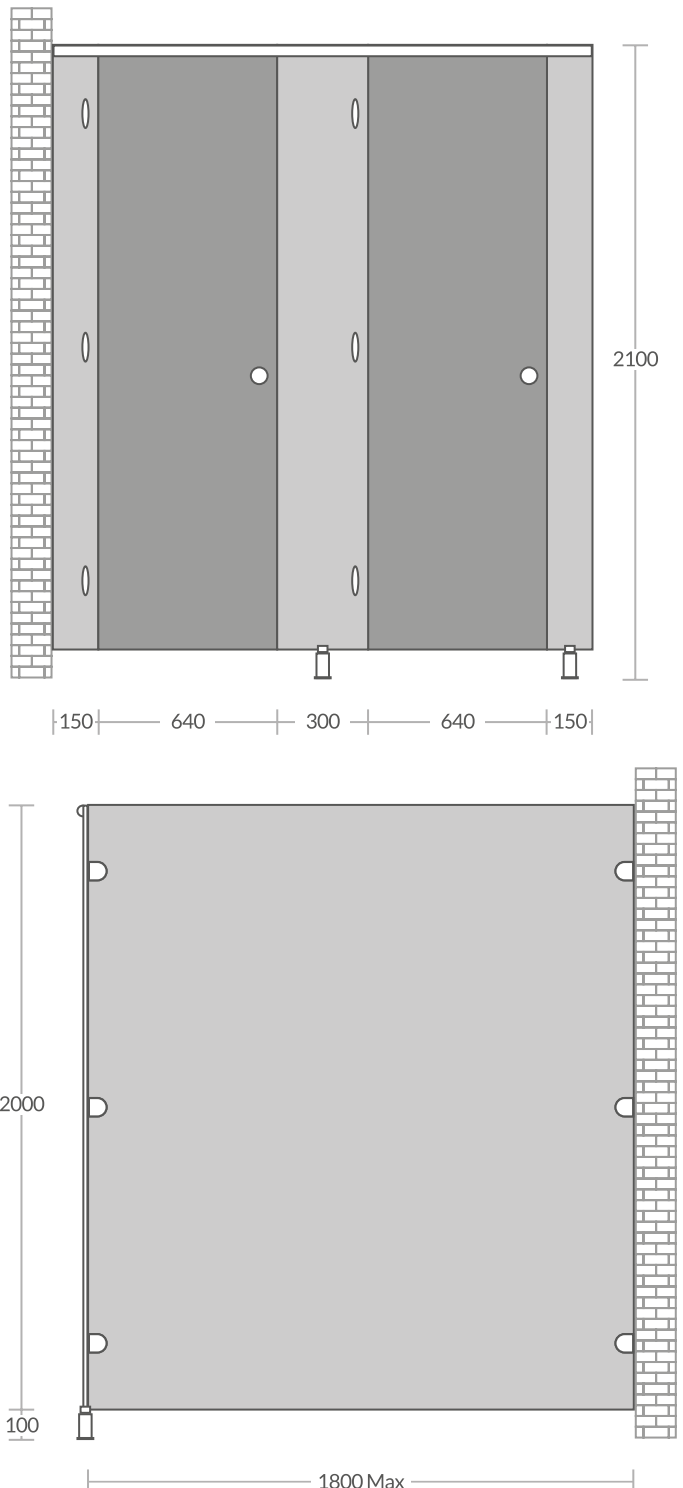

Sydney[®] Cubicle System



Uniclass 1.4 L2226
Uniclass 2015 Ss_25_12_60_60

NBS Create
Keynote

25-05-60/160
K32/120

Manufacturer

Cubicle Centre
+44 (0)1924 457600

design@washroomcubicles.co.uk

Available Downloads

CAD BLOCK
.dwg format

BIM OBJECT
.rfa format

NBS PLUS
Create Specification

Product reference Sydney Cubicle System
Material Melamine Faced Chipboard

Overall cubicle height

1500mm including a 100mm floor clearance

Partitions

Partition depth 1500mm (standard)
Up to 1800mm
Partition height 1100mm
Colour See below

Doors

Door height 1100mm
Colour See below
Decorative vinyl Happy Everything, Space Adventure
Colourful Chameleons, Ocean View

Fittings

SAA: brackets, floor supports, heavy-duty hinges, door handles and magnetic catches

Wall Panel System

Height Not required, Full-height, Half-height
Material Melamine Faced Chipboard
Panel colour See below
Flash colour See below

Colour

Blue, Red, Yellow, Green, White, Cream, Plain Grey, Stone Grey, Blueberry, Kiwifruit, Mango, Dragon Fruit

Notes

[Sydney is available in CGL @ extra cost](#)

Standard Sydney Dimensions

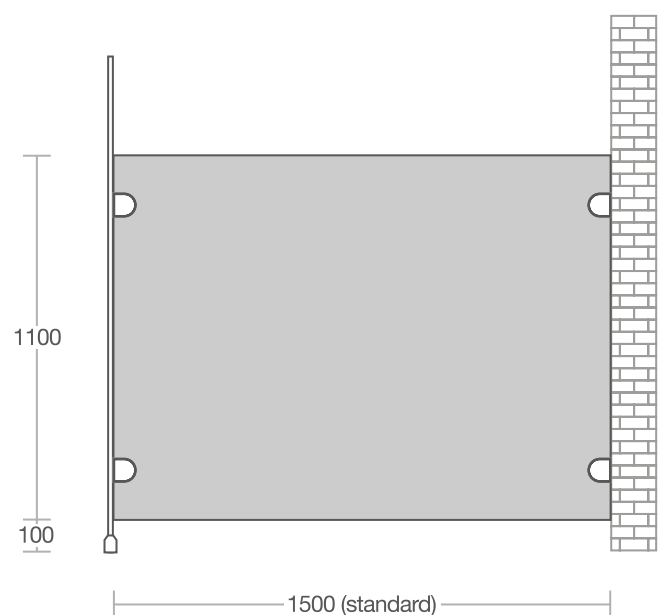
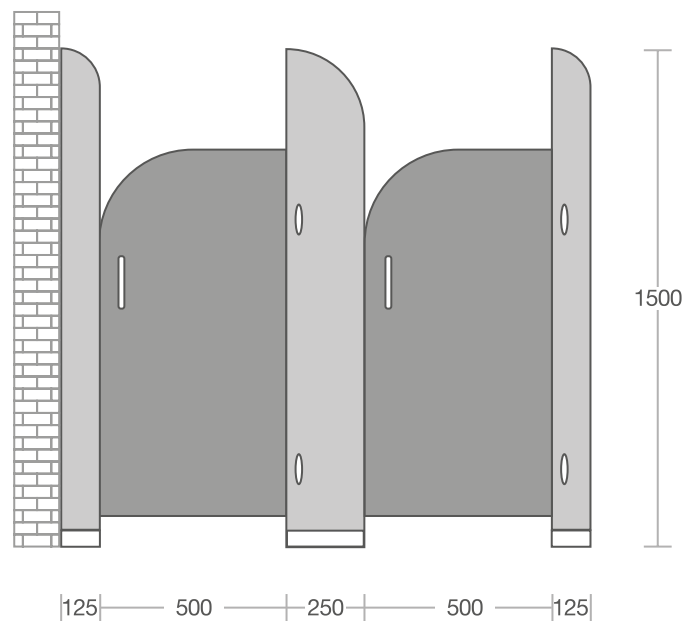

Vanity Units



Uniclass 1.4 L7212
Uniclass 2015 Pr_40_20_76_94

NBS Create 45-35-72/378
Keynote N10/145

Manufacturer

Cubicle Centre
+44 (0)1924 457600
design@washroomcubicles.co.uk

Available Downloads

CAD BLOCK .dwg format	BIM OBJECT .rfa format	NBS PLUS Create Specification
---------------------------------	----------------------------------	---

Product reference	Vanity Unit
Material	High Pressure Laminate (standard) Compact Grade Laminate
Overall vanity height	850mm (standard) or to suit individual requirements
Vanity type	Type Inset (550mm deep) Semi-Recessed (350mm deep)
Vanity top	Material High Pressure Laminate (standard) Compact Density Fibreboard Compact Grade Laminate Colour See below
Vanity panels	Material Melamine Faced Chipboard (standard) High Pressure Laminate Compact Density Fibreboard Compact Grade Laminate Colour See below
Light pelmet	Material High Pressure Laminate (standard) Colour See below
Colour	HPL (standard) www.washroomcubicles.co.uk/high-pressure-laminate/ MFC www.washroomcubicles.co.uk/melamine-faced-chipboard/ CDF www.washroomcubicles.co.uk/compact-density-fibreboard/ CGL www.washroomcubicles.co.uk/compact-grade-laminate/

Inset Vanity Unit

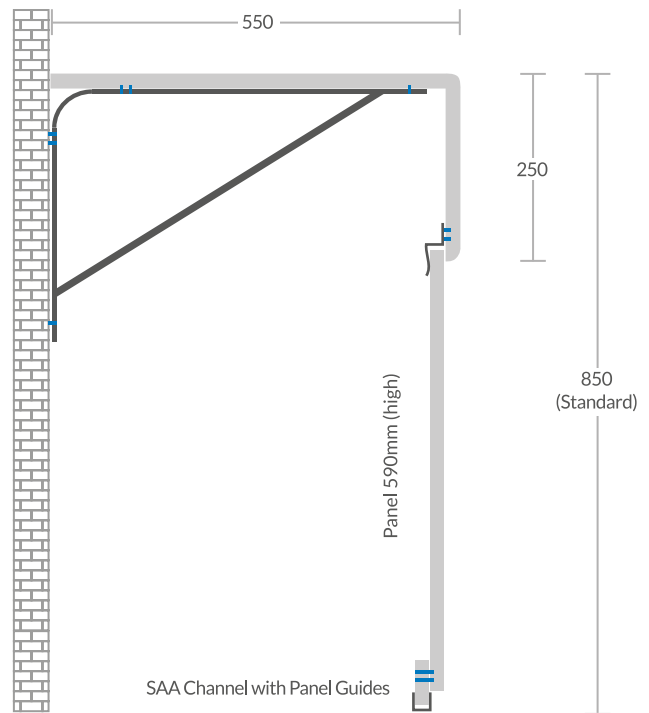

Semi-Recessed Vanity Unit

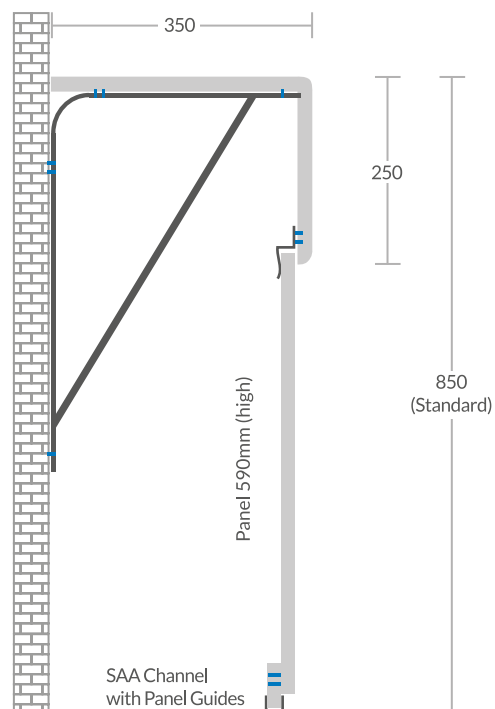

Wall Panel Systems



Uniclass 1.4 L516
Uniclass 2015 Ss_25_25_45_25

NBS Create 25-85-45/120
Keynote K32/140

Manufacturer

Cubicle Centre
+44 (0)1924 457600

design@washroomcubicles.co.uk

Available Downloads

CAD BLOCK .dwg format	BIM OBJECT .rfa format	NBS PLUS Create Specification
---------------------------------	----------------------------------	---

Product reference Wall Panel System
Material Melamine Faced Chipboard (standard)
High Pressure Laminate
Compact Grade Laminate
Compact Density Fibreboard

Overall panel system height
Up to 2800mm - can be manufactured to suit individual requirements

Panels
Height Up to 2800mm
Full-height
Half-height (1200mm standard)
Material Melamine Faced Chipboard (standard)
High Pressure Laminate
Compact Grade Laminate
Compact Density Fibreboard
Panel colour See below
Panel edging 2.0mm PVC lipping (MFC or HPL)
Post-formed verticle edges (HPL)
Black, machine rounded profile (CGL or CDF)
Flash colour See below

Framing
Timber frame supplied by other

Colour
MFC (standard)
www.washroomcubicles.co.uk/melamine-faced-chipboard/
HPL
www.washroomcubicles.co.uk/high-pressure-laminate/
CGL
www.washroomcubicles.co.uk/compact-grade-laminate/
CDF
www.washroomcubicles.co.uk/compact-density-fibreboard/

Wall Panel Configurations

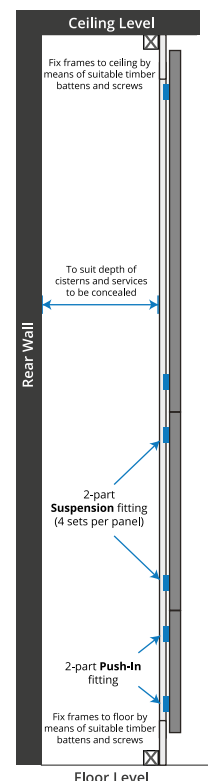
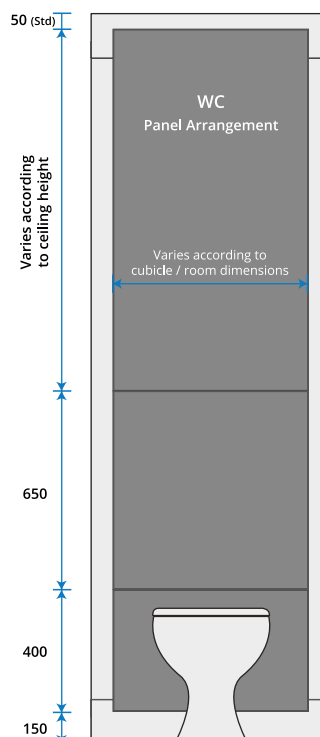
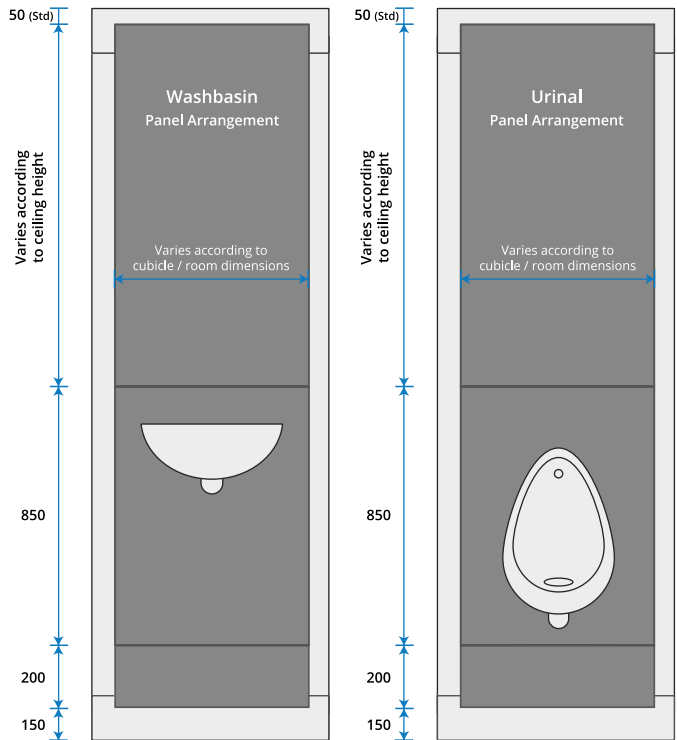

Timber frame supplied by other

Pendle Panel Systems



Uniclass 1.4 L516
 Uniclass 2015 Ss_25_25_45_25

NBS Create
 Keynote

25-85-45/120
 K32/140

Manufacturer

Cubicle Centre
 +44 (0)1924 457600

design@washroomcubicles.co.uk

Available Downloads

CAD BLOCK
 .dwg format

How to Order

Pendle cubicles can be ordered quickly and easily online.

To place your order visit:

www.plumbware.co.uk

Product reference Wall Panel System

Material Melamine Faced Chipboard

Overall panel system height

1950mm to match Pendle/Pendle Junior cubicle system

Panels

Height 1950mm
 Material Melamine Faced Chipboard
 Panel edging 2.0mm PVC lipping (MFC)

Framing

Timber frame supplied by other

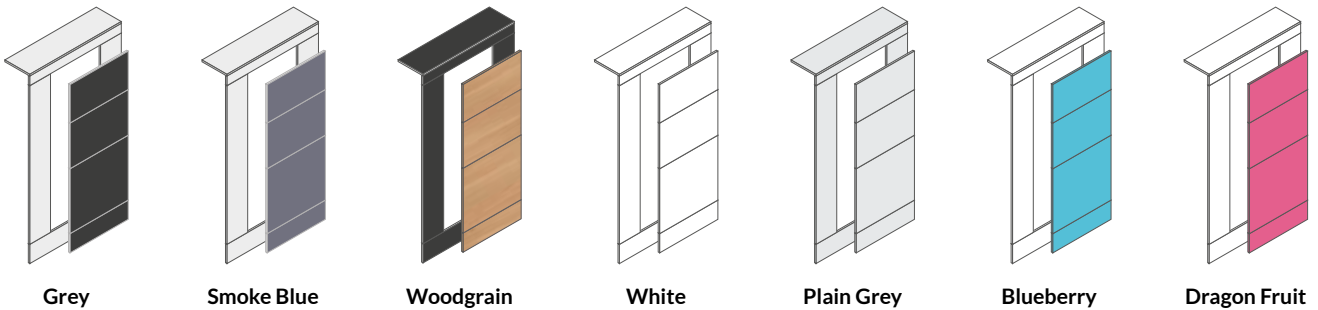

WC Panel System

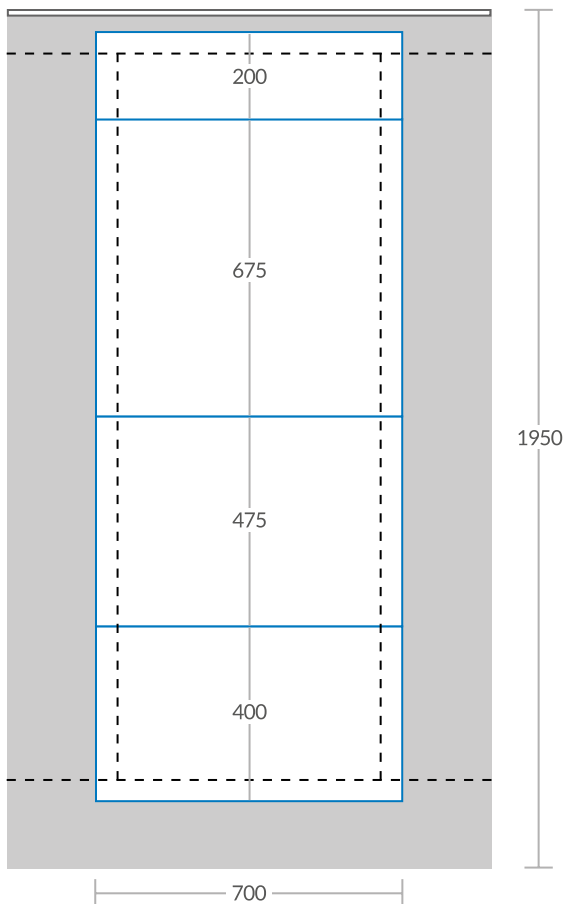

Urinal Panel System

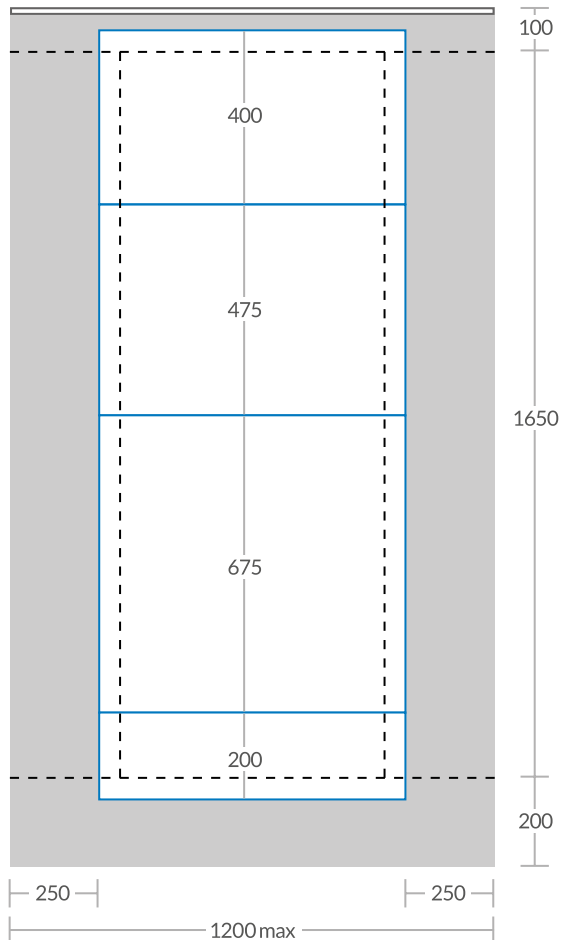

Frequently Asked Questions

Do you offer a fit-out service?

Cubicle Centre manufacture and supply only.

Our washroom systems are designed to be easily assembled by competent tradespersons.

Can I buy replacement / spare parts?

Maintenance Packs (including spare fittings) can be supplied with your initial order on request, at extra cost.

Replacement parts will only be sold for Cubicle Centre washroom systems.

What is the recommended minimum size for a standard toilet cubicle?

750mm (wide) x 1500mm (deep)

See page 38 for Universal Access Guidelines.

What is the 'cubicle configuration'?

We need to know which of the following four situations your cubicles will be fitted in:

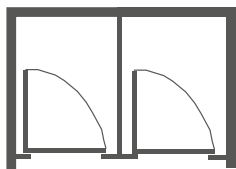

Enclosed
(between walls)

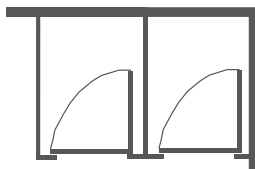

Corner

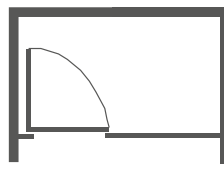

In-Line

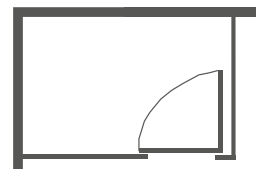

In-Line with Return

What is your budget range of toilet cubicles?

Pennine (page 09) offers a practical washroom solution for those with a low budget.

See page 04 for Cubicle Product Guide.

I need some cubicles urgently...

The *Pendle* and *Pendle Junior* cubicle systems are usually dispatched within 48 hours of order. See page 06 and 07 for further details. The complete *Pendle* range can be ordered online at Plumbware.co.uk



How do I get a quote?

Due to the majority of products being made to measure, pricing is on a job-to-job basis.

Email (sales@washroomcubicles.co.uk) your washroom requirements to us along with a drawing or sketch and we'll do the rest.

Alternatively, visit www.washroomcubicles.co.uk/quote to fill in an online form. Our sales team are on hand to answer any questions you may have on 01924 457600.

Frequently Asked Questions

How quickly can I have my order?

Lead times can vary from 5 to 15 working days depending on your specific requirements.

PLEASE NOTE: Lead times may increase during busier periods of the year (i.e. school holidays)

Those looking to refurbish washrooms during school holidays are advised to place their order several weeks beforehand.

Which product is best suited for use in shower / changing areas?

The *Cairngorm*, *Cotswold* and *Privacy* cubicle systems are suited for use in shower / changing areas or in areas that are likely to be subject to a wet environment or vandalism.

What are the different types of panel material?

Our products have various types of panel materials suited to different environments. *Melamine Faced Chipboard (MFC)* is suited to standard washrooms, while *Compact Grade Laminate (CGL)* is waterproof and durable and perfect for heavy use washrooms. A full description of each material can be found on page 05 Material Guide.

Do you offer screen printed doors for children's cubicles?

Cubicle Centre offer an alternative range of exclusive vinyl designs which can be applied to your cubicle doors on request. See below for some of the designs available.

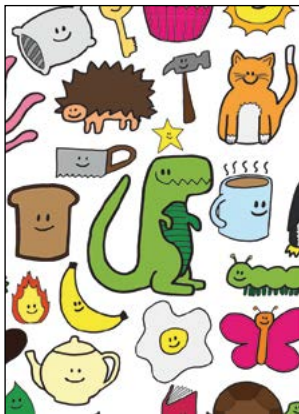

Happy Everything



Space Adventure



Colourful Chameleons

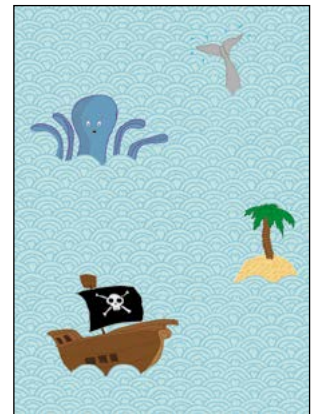

Ocean View

What should I clean the cubicles with?

For MFC products, remove general stains and marks with a proprietary non-abrasive bathroom or kitchen surface cleaning solution on a damp cloth. Do not use excessive amounts of water or solution.

CGL products are water proof and can therefore be cleaned more intensely with water and solution.

Avoid scrubbing or using anything with sharp edges in contact with the panels.

Can I open an account?

You may apply to open an account with us.

Account application forms are available from our website:

www.washroomcubicles.co.uk/downloads/DART-Credit_Application.pdf

Unless you currently hold an account with us, all made to measure bespoke items are subject to pro-forma prepayment.

We accept: BACS / CHAPS or



Frequently Asked Questions

How do I install my cubicles?

Cubicle Centre manufacture and supply only and recommend that fitting is done by a competent joinery team. Each range has its own set of fitting instructions sent with the order. Our team can help with any other instructions via telephone.

How do I calculate the number of toilets and wash basins I should provide?

The British Standard 6465-1:2006 Sanitary Installations document has information, formulas and tables explaining how many toilets, urinals and basins should be provided. The calculations are different for each location. The document covers, schools, offices, shopping centres, entertainment venues, restaurants, pubs and swimming pools. A full break down can be found at:

www.washroomcubicles.co.uk/how-many-toilets-do-you-need/

Are there any regulations I need to consider when planning a washroom?

Different sectors have different washroom regulations. For example a school has different toilet layout regulations to an office. To save time and effort when planning your project we created PDF guides for different sectors. Schools, offices, leisure centres, stadiums and holiday parks are all covered.

To download your guide visit:

www.washroomcubicles.co.uk/washroom-guides/

Do you offer any help to architects or specifiers?

We have created a range of resources to help with the planning of a washroom project. 2D CAD drawings 3D BIM files, specification sheets and a customised specification tool are all available at:

www.washroomcubicles.co.uk/architects/

Do you offer any posters for children?

We created a range of fun illustrated posters that remind children to wash their hands, put rubbish in the bin and drink water. These can be downloaded for **free** from:

www.washroomcubicles.co.uk/posters/



Disclaimer

© 2018 Cubicle Centre

Whilst every care has been taken to ensure the information included in this brochure was correct at the time of printing, we reserve the right to change specifications at any time without prior notice. Where specification is critical, please contact us to ensure you have the latest available information. The colours in this brochure are within the constraints of the printing process and are NOT to be used for matching purposes.

Disability Discrimination Act - Building Regulations:

The responsibility for washroom compliance with current building regulations lies with the project manager. However, on request, we can offer advice on this subject.



Full range of sanitary ware available to buy online



plumbware.co.uk

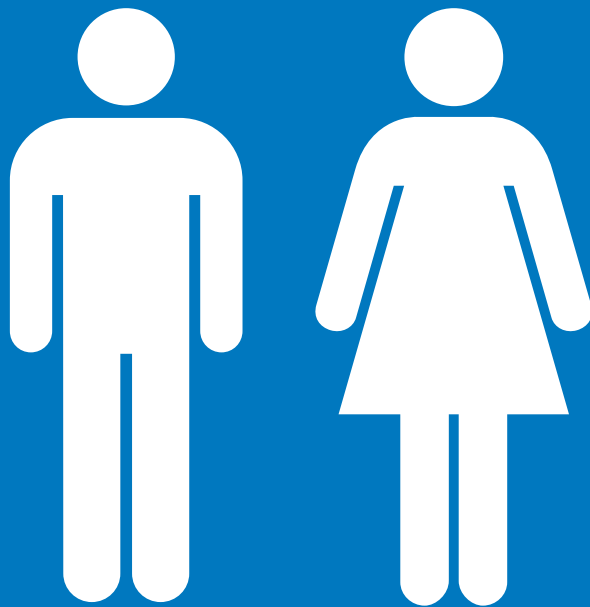

cubicle centre

Tel: 01924 457600 | Fax: 01924 437600 | Email: sales@washroomcubicles.co.uk | Web: www.washroomcubicles.co.uk

Cubicle Centre, Caldervale Business Park, Huddersfield Road, Ravensthorpe, West Yorkshire, WF13 3JL

Cubicle Centre is the trading name of DART Cubicles LLP. Registered in England No. OC376041. Printed January 2018.