

Easyflush Direct

Installation
guide

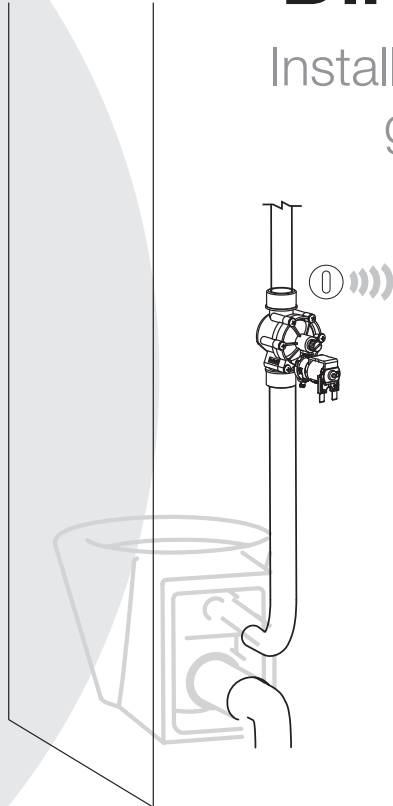

Please keep this booklet for future reference.

Installer, when you have read these instructions
please ensure you leave them with the user.



Made in
BRITAIN



1. Introduction

The Easyflush Direct valve provides electronic flushing of the WC without the need for a WC cistern. There are two versions:

Easyflush Wave is operated by the user bringing their hand towards the infrared sensor. A part flush is triggered by holding the user's hand in place for 1 second; a full flush is triggered by a hand pass of over 1 second. The dual flush setting is a factory default but can be changed by the installer.

Easyflush Direct Walkaway is activated when the user stands up or leaves the cubicle but it can also be activated by the user bringing their hand toward the sensor. The dual flush setting is a factory default but can be changed by the installer. A part flush is triggered by short user occupancy and a full flush by long user occupancy (over 45 seconds).

With Easyflush Direct there is no cistern to be refilled; this means a second flush can be activated without a delay. The product includes a hygiene rinse function.

Supplied parts

1. Sensor unit
2. Valve unit
3. Sensor nut
4. Sensor rubber gasket
5. Clamp plate
6. DC pipe interrupter
7. Valve rubber seal
8. Cap seal
9. Cap washer
10. Cap nut
11. 1.5" flush pipe fitting
12. Long screws
13. Short screws
14. Sticky pad
15. 6mm screw packer
16. Extension cable
17. Mains adapter

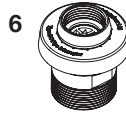
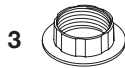
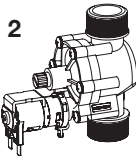

2. Installation

IMPORTANT: Read this before fitting the WC valve.

Flushing directly from the mains water supply

When flushing WCs or urinals directly from the mains, the Water Regulations require that the water supply be protected by a suitable category 5 protection method or device.

In the case of WCs, this can be achieved in three ways:

1. The use of a dedicated supply for flushing use only, supplied from a break tank that protects the mains supply with a type AA, AB or AD air gap.
2. The use of a specific type of WC bowl which has been tested and shown to incorporate the equivalent of a type AB air gap.
3. The use of a WRAS approved type DC pipe interrupter (supplied with all Cistermiser Direct Flushing products).

A note about type DC pipe interrupters

These devices have an integral air gap; it is therefore important that pipework design and WC bowl selection are appropriate to ensure sufficient flow to flush the WC while preventing water flowing back up and out of the air gap.

The DC pipe interrupter must be installed not less than 150mm above the spill over level of the WC pan.

Ensure you follow these key design & installation points

- Install the valve as high as possible above the WC bowl.
- Install a free-flowing, low restriction connection from the valve to the WC bowl.
- Use a large pipe size in the pipework between the DC pipe interrupter and the WC.
- Make use of the flow regulators provided; if you still have issues with the DC pipe interrupter overflowing, it may be necessary to install a further flow restricting device upstream of the valve.

NOTE: For grey water/rain harvesting. Ensure adequate filtering is fitted, a 10µm filter is recommended.

NOTE: For chemical water treatment. If the water system had been treated with chemical dosing, ensure the system is thoroughly flushed before fitting any Cistermiser products. Concentrated chemicals in dead legs can damage the product and result in failure. If the water is treated with Chlorine Dioxide (ClO₂), ensure concentration levels are maintained below 5ppm.

NOTE: As with all water containing products, limescale in hard water areas can affect the products performance. This can result in maintenance to remove the limescale when required.

3. Installation schematic

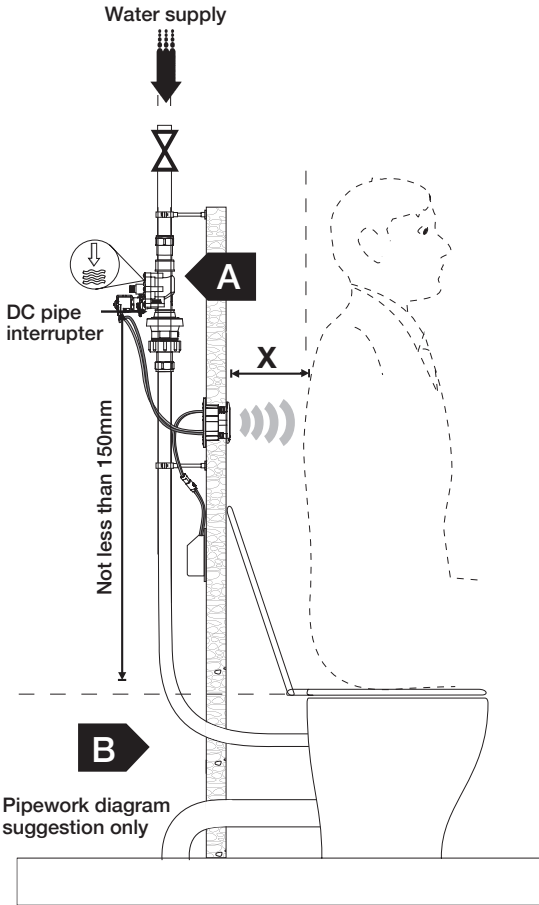

X – Walkaway version only

If this distance is less than 12cm it is recommended that the Hand Activation is disabled. Refer to Section 9. (ICU required; not supplied.)

NOTE: Flush pipework prior to installation. Do not install opposite a mirror. When installed opposite a shiny surface, the range may require adjustment. See section 8 Advanced settings guide.

The valve must be installed at least 150mm above the spill over level to comply with Water Regulations.

When installing the valve it is good practice to ensure there is an accessible isolating valve upstream of the valve.

Ensure flow rate at valve **A** does not exceed the flow rate to the WC bowl **B**, to prevent water backing-up to the DC pipe interrupter.

A 1.5m extension cable is supplied if required for placement of sensor.

DMA55 power supply included with Easyflush Direct (Requires 1A fused spur)

Panel mounted sensor

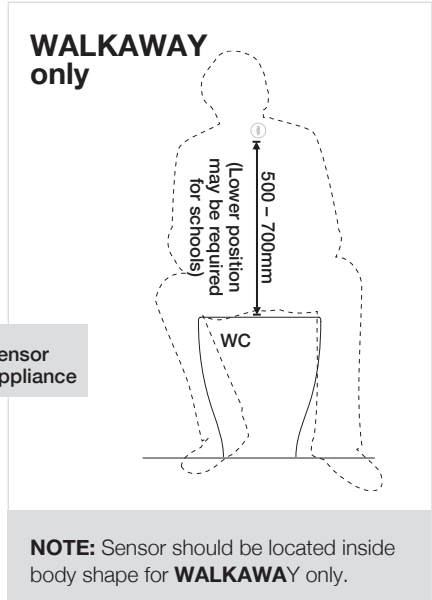
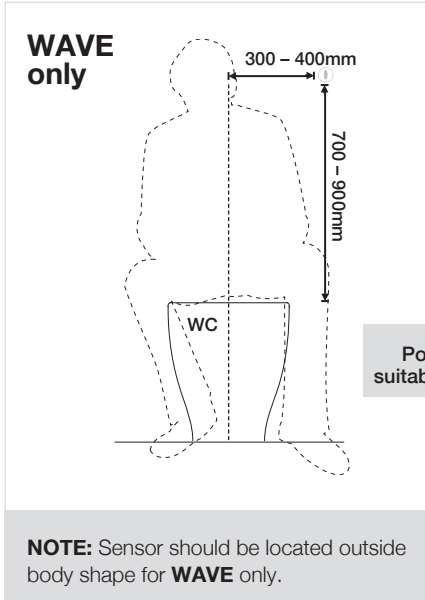

OR

Position sensor suitable for appliance

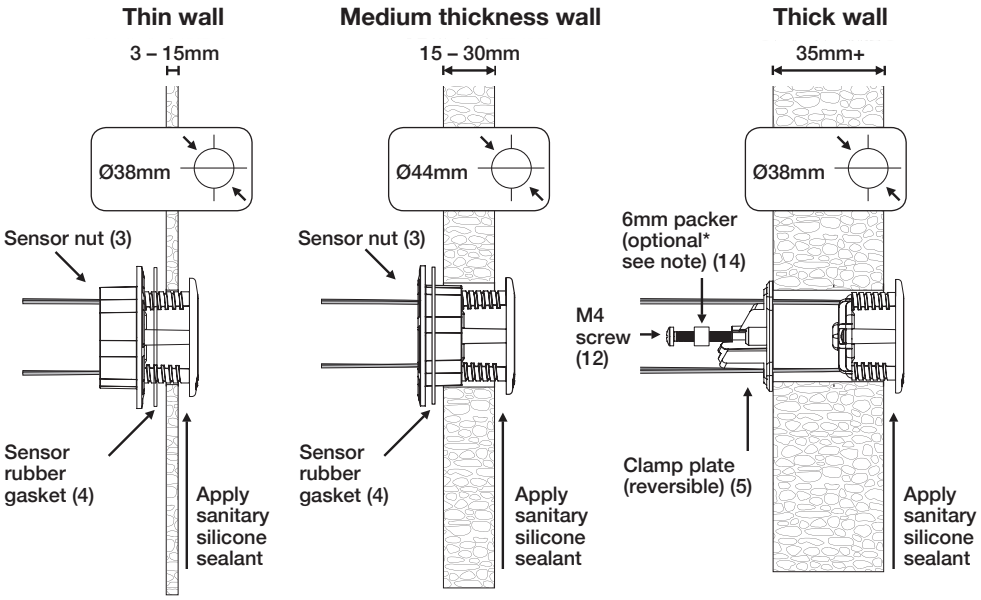

NOTE: *If wall thickness is under 35mm use packer to prevent screw causing damage to sensor.

Easyflush Direct is supplied with a DC pipe interrupter and a 1.5" flush pipe fitting. Fit the DC pipe interrupter to the valve outlet ensuring the rubber seal is in place.



← Rubber seal

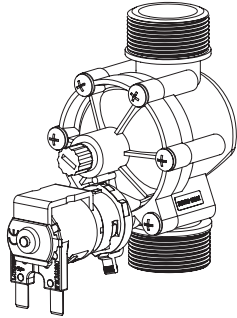

← 1" BSP connection

NOTE: To connect to supply pipework you will require a 1" female BSP to 22mm or 28mm (copper) connection (not supplied).

← Easyflush Direct valve



← Rubber seal

If the DC pipe interrupter is not required (see 'Flushing directly from the water supply in Section 2), fit the 1.5" flush pipe fitting, in place of the DC pipe interrupter. Fittings are supplied to connect to a 38mm (1.5") flush pipe.

← 1.5" flush pipe fitting

PLEASE NOTE THAT:
Removing the DC pipe interrupter may contravene the Water Regulations (see page 3).

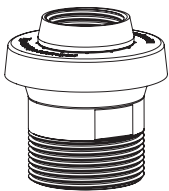

← DC pipe interrupter



← Flush pipe fittings

NOTE: If you wish to connect to a 2" flush pipe, an adapter can be purchased from your local plumbing merchant.



4. Power connections

DMA55 power supply included with Easyflush Direct (Requires 1A fused spur)

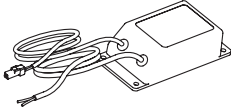

Fasten the mains adapter into place on the panel in a dry location using the screws or adhesive pads provided and connect the un-terminated mains cable to a 50Hz 230V AC single phase supply via a 1A fused spur (not supplied).

Connect the spade connectors from the sensor to the solenoid terminals; take care to connect the wires according to the colour coding on the label. If the wires are not long enough they can be extended by up to 1.5 metres with the cable supplied.

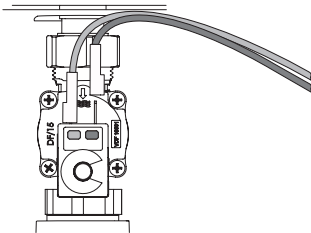

Electrical connection

Connect the power connector from the sensor to the mains adapter.

NOTE: Remove the label from the sensor BEFORE connecting to the power. When the power is first connected the LED in the sensor flashes amber. This is normal and lasts only a few seconds.

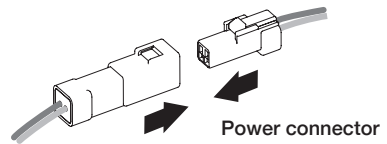

Alternative power options

For multiple connections the Cistermiser power supply unit (PSUC) can be used to power up to 20 units (not supplied).

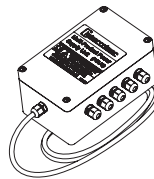

NOTE: When using a Cistermiser power supply unit (PSUC), ensure that when connecting correct polarity is ensured. Brown wire = positive
Grey wire = negative

Additional configuration options

With the Infrared configuration unit (ICU) remote control (sold separately).

- Hygiene rinse on/off. The installer is able to switch the 12 hr hygiene rinse function on or off.

- Clean mode. The Easyflush Direct can be disabled for a short period to allow for cleaning.
- Siphonic trap refill mode. When activated this allows a small flush after every flush to refill the siphonic trap.
- Toggle wave feature on/off.

5. Configuration

IMPORTANT – water flow rate requirement

To achieve an effective and efficient flush, the water system needs to deliver at least 90 lpm. Typically this would require that the dynamic/working water pressure, measured before the valve, is at least 2 bar.

To comply with the water regulations the full flush volume must not exceed 6 litres.

The Easyflush Direct is fitted with a 100 lpm flow regulator* that will limit the flow through the valve to 100 lpm.

The flush duration is set by default to 3.5 seconds, this ensures the flush volume will be below 6 litres. The part flush will automatically be set to 0.6 x the full flush duration. This will ensure the part flush volume is less than 2/3rd the full flush volume as specified in the Water Regulations.

To adjust the flush duration and therefore the flush volume see Section 10 'configuring the full flush duration'.

*Alternative flow regulators are available. Please contact Cistermiser.

NOTE: On smaller pipe sizes please pay particular attention that you achieve 90 lpm at the valve outlet for an effective flush.



WARNING:

The use of several other appliances from the same water supply simultaneously may reduce the flow rate below 90 lpm.

The flow rate can also be reduced by turning the adjuster screw in the middle of the valve (clockwise to reduce flow) or by fitting a third party pressure reducing valve above the Easyflush Direct.

Ensure that the dynamic water pressure (pressure measured while the valve is open and water is flowing) is sufficient to achieve the required flow rate.

6. Usage advice and specification

Minimum working pressure:	An effective and efficient flush is achieved with a flow rate of >90 lpm. A typical installation will require 2bar dynamic pressure, measured before the Easyflush Direct, to achieve 90 lpm.
Maximum working pressure:	5 bar

NOTE: When using the Easyflush Direct valve from a mains water supply, the pressure may be higher than is suitable for the design of the bowl which can cause splashing to occur. In such cases fit a flow regulator (supplied) as indicated in Section 5.

Back siphonage protection:	Class 5, Type DC
----------------------------	------------------

Factory settings

Range:	EFD Wave – circa 18cm EFD Walkaway – circa 65cm (9cm for hand activation)
Full flush duration:	3.5 seconds
Part flush duration:	2 seconds
Power requirements:	6V DC regulated from mains adapter (1A fused spur required)
Cleaning:	Clean with soap and water only
Lens care:	Infrared lens can be polished with a soft cloth

Electronic specification

Control classification	Independent
Maximum load:	2W, 0.33A (6VDC)
Rated temperature range:	0-40 deg C
Action classification:	Type 1.Y
Pollution classification:	Degree 1
Ingress protection:	IP65

7. Component dimensions

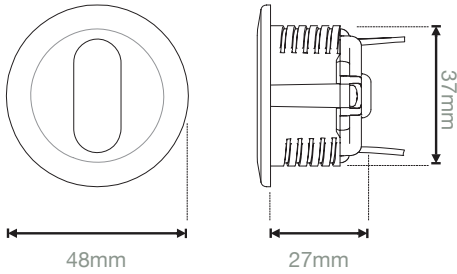
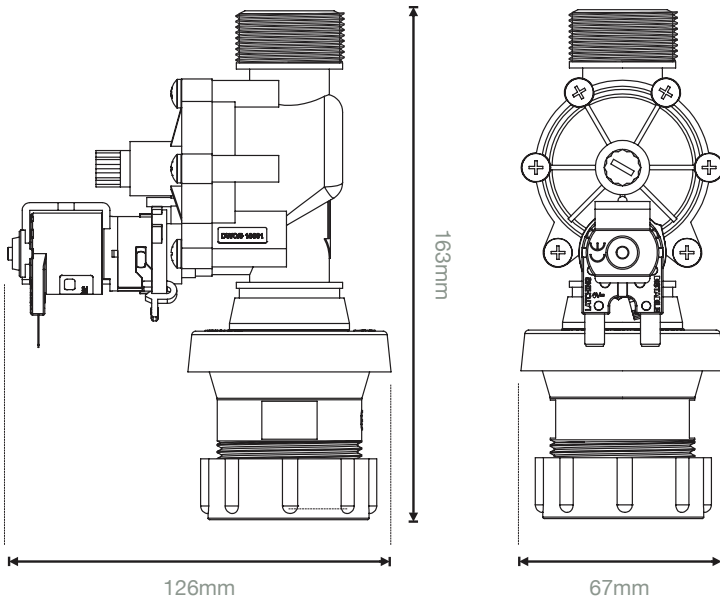







8. Advanced settings guide





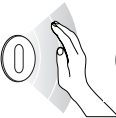

Easyflush Walkaway





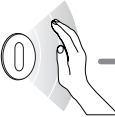



Carry out only if standard (default) settings are found to be unsuitable on first use.

-  Disconnect power, wait for 5 seconds and reconnect. Solid amber while ambient light detected. 
-  When **flashing amber**.  Place hand 4-6cm from sensor until **constant green**, then remove hand.  
-  You are now in configuration mode
If a hand is not placed over the sensor, it will go into normal operation mode.

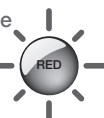
Sensing range of adjustment

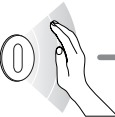
-  Wait for **single red flashing LED** to enter sensing range mode. 
-  Briefly place your hand in front of the sensor until the **green LED flashes slowly**. Range configuration mode will then be ready.  
-  Stand at the distance from the sensor you would like to set at maximum range. Wait 8 seconds until **constant green LED** shows.   Sensor distance is now set.

Full flush duration adjustment

-  Wait for **double red flashing LED** to enter full flush time.  **x 2**
 -  During **double red flashing**, briefly place your hand in front of the sensor. The valve will flush and the cistern will refill. A **green flashing LED** will be seen. Hold hand steady.  
 -  When the flush has run for the desired time, move your hand out of the line of sight of the sensor. The water will cease and the flush duration will be set to a maximum of 4 seconds.
-  After configuration the unit will **flash amber**, giving opportunity to re-enter 

NOTE: Part flush duration will be automatically set at 0.6 x full flush duration.

Easyflush Direct Wave Carry out only if settings need to be changed

1 Disconnect power, wait for 5 seconds and reconnect.

2 When **flashing amber**.



Place hand 4-6cm from sensor until **constant green**, then remove hand.

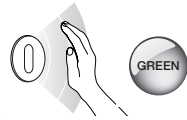

3 You are now in configuration mode

If a hand is not placed over the sensor, it will go into normal operation mode.

Sensing range of adjustment

A Wait for **single red flashing LED** to enter sensing range mode.



B Briefly place your hand in front of the sensor until the **green LED flashes slowly**. Range configuration mode will then be ready.

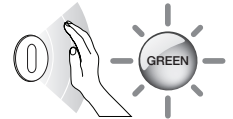

C Move your hand to the distance from the sensor you would like to set as maximum range. Wait 8 seconds until **constant green LED** shows.



Sensor distance is now set.

Full flush duration adjustment

A Wait for **double red flashing LED** to enter full flush time.

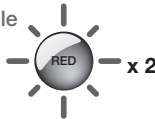

B During **double red flashing** briefly place your hand in front of the sensor. The valve will flush and the cistern will refill. The valve will flush while **the green flashing** will be seen. Hold hand steady.

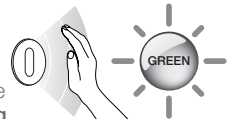

C When the flush has run for the desired time, move your hand out of the line of sight of the sensor. The water will cease and the flush duration will be set to a maximum of 4 seconds.

4 After configuration the unit will **flash amber** giving opportunity to re-enter

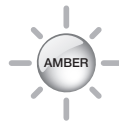









NOTE: Part flush duration will be automatically set at 0.6 x full flush duration.



9 Infrared Configuration Unit (ICU) guide

NOTE: Not supplied but recommended for multiple installations. ICU is available from Cistermiser or any major plumbing merchant.

Button descriptions

-  Activates cleaning mode
-  Activates ICU configuration mode
-  Decreases setting
-  Increases setting
-  Checks the setting being altered
-  Saves changes and exits ICU configuration mode
-  Quits ICU configuration mode without saving changes
- 1**  Configures sensor range
- 2**  Configures full flush duration
- 4**  Configures hand wave
- 5**  12 hour hygiene cycle activation
- 6**  Dual flush activation
- 7**  Autorange setting of sensor range
- 9**  Resets to default factory settings



- 3**  Not used
- 8**  Not used

Entering configuration mode

Point the ICU towards the Easyflush Direct sensor and push the configuration  button. Activation is most effective when the configuration button is held down as the ICU is brought close to the sensor.

Sensor blinks red when ICU is detected. It can take up to three seconds for the product to sense the ICU. The Easyflush Direct will return to normal operation if there are no button presses for 30 seconds.

Configuring sensor range

Point the ICU at the Easyflush Direct sensor and press the **1**  sensor range button (the sensor blinks green).

Decrease or increase the sensor range by pressing the  and  buttons respectively.

The sensor blinks red when the min or max value is reached.

Press the  button to check the sensor range setting – the sensor displays the current setting by flashing green; see table.

For Wave version

Number of flashes	1	2	3	4	5
Range (cm approx)	6	9	11	15	17

For Walkaway version

Number of flashes	1	2	3	4	5
Range (cm approx)	45	50	53	56	58

Save setting and exit ICU configuration mode by pressing  the button.

Exit without saving by pressing the  button.

Configuring part flush time

Point the ICU at the Easyflush direct sensor and press the **2** (⏸) flush time button (the sensor blinks green).

Decrease or increase the part flush time by pressing the **⏪** and **⏩** buttons respectively. The sensor blinks red when the min or max value is reached.

Press the **OK** button to check the part flush time setting – the sensor displays the current setting by flashing green; see table.

Number of flashes	1	2	3	4	5
Part flush time (sec)	1	2	3	4	5

Save setting and exit ICU configuration mode by pressing the **SAVE** button.

Exit without saving by pressing the **QUIT** button.

Activating and de-activating the hand wave flushing (walkaway version only)

Point the ICU at the Easyflush Direct sensor and press the **4** (⏸) (the sensor blinks green). By default the hand wave function is on.

Pressing the **⏪** and **⏩** button switches the hand wave function on or off respectively.

Press the **OK** button to check the setting – the sensor flashes green once if function is off or twice if it is on.

Save setting and exit ICU configuration mode by pressing the **SAVE** button.

Exit without saving by pressing the **QUIT** button.

Activating the 12-hour hygiene flush cycle

Point the ICU at the Easyflush Direct sensor and press the hygiene cycle **5** (⏸) button (the sensor blinks green).

Pressing the **⏪** and **⏩** buttons switches the hygiene flush function on or off respectively.

Press the **OK** button to check the setting – the sensor flashes green once if function is off or twice if it is on.

Save setting and exit ICU configuration mode by pressing the **SAVE** button.

Exit without saving by pressing the **QUIT** button.

Activating the dual flush function

Point the ICU at the Easyflush Direct sensor and press the **6** (⏸) (the sensor blinks green).

Pressing the **⏪** and **⏩** buttons switches the dual flush function on or off respectively. Press the **OK** button to check the setting – the sensor flashes green once if function is off or twice if it is on.

Save setting and exit ICU configuration mode by pressing the **SAVE** button.

Exit without saving by pressing the **QUIT** button.

Configuring sensor range using the autorange function

If the cubicle door is opposite the sensor, ensure that the cubicle door is closed or ajar, but not fully open.

Point the ICU at the Easyflush Direct sensor and press the **7** (⏸) button.

Immediately stand clear of the sensor. Sensor blinks green for 5 seconds, then a steady green when setting complete. The sensor measures the background reflections and sets the sensor range to an appropriate setting.

Save setting and exit ICU configuration mode by pressing the **SAVE** button.

Exit without saving by pressing the **QUIT** button.

Reset to factory settings

Enter into configuration mode. Point the ICU at the Easyflush Direct sensor and press the **9** (⏸): the sensor blinks green once. This returns all settings to the default factory settings.

To save the setting and exit ICU configuration mode press the **SAVE** button. The sensor will blink green for one second and then constant amber for three seconds.

To exit without saving press the **QUIT** button. The sensor will blink red for one second and then constant amber for three seconds.

10. Troubleshooting

Indicators for normal sensor function after user activation

Wave:

- Single green flash once a second (if part flush)
- Double green flash once a second

Walkaway:

- 3 seconds between green flashes (if a presence is detected)
- Single green flash once a second (if part flush)

No water is entering the bowl

No obvious indicator	Ensure that the water supply is reaching the valve.
	Blockage. Ensure the filter on the inlet of the valve is clear.
	Water pressure <0.5 bar >5 bar can cause valve to not open or close.
The sensor is obscured	This occurs when an object/debris blocks or covers the sensor, the object/debris needs to be removed from the sensor and Easyflush Direct will resume normal functionality.

The valve is not working at all

The sensor light does not flash when a hand is placed in front of it.	Ensure the power supply is connected and wired correctly.
Sensor is flashing red slowly or not at all when hand is placed in front of it.	Low or no power. Ensure spur is live and 6v DC from DMA55 power adapter. Check connection for damp.
No obvious indicator	Ensure there is a good water supply and dynamic pressure of 2 to 5 bar.

Continuous flow into the WC bowl from the valve

No obvious indicator	Ensure water pressure is min 0.5 bar. Flush any potential debris out of the valve.
Sensor is flashing red slowly	Low or no power. Contact Cistermiser.

WC flushes when in use

Working as normal	Ensure that the sensor is mounted in the correct position. Refer to installation schematic (Section 3).
	Ensure the sensor range is correctly configured. Refer to the advanced setting guide (Section 8) or Infrared Configuration Unit (ICU) guide.

10. Troubleshooting

Flush is ineffective

Working as normal otherwise	Ensure the flow rate of the water supply is 90 lpm.
Blockage	Ensure the filter on the inlet of the valve is clear.

Other issues

Double red flash	Faulty wiring. Check wiring carefully.
	Faulty solenoid. Call Cistermiser for advice.
Red flash once every second	Low or no power. Contact Cistermiser.
Red flash twice every three seconds	Sensor covered or heavily scratched. Uncover or polish out scratches.

Cistermiser product warranty and extended warranty

Cistermiser products are guaranteed for 12 months from the date of manufacture. The guarantee is for faulty products and parts only: there is no labour warranty. If you believe your product is faulty, please either contact Cistermiser directly on **0118 969 1611** or at **support@cistermiser.co.uk**, with a photograph and the serial number, to help diagnose the cause of the problem.

The warranty on Cistermiser products can be extended, at no cost within one year of date of manufacture, to three years from the date of installation by completing the enclosed warranty card or at **www.cistermiser.co.uk/warranty**. Please make a note of the serial number and take a photograph of the installation before you leave site.

Commissioning check-list

Easyflush Direct

Cistermiser products are guaranteed for 12 months from the date of manufacture. The guarantee is for

<h1 style="font-size: 48px; margin: 0;">3</h1> <p style="font-size: 24px; margin: 0;">YEAR extended warranty</p>	<p>The warranty on Cistermiser products can be extended within one year of date of manufacture, at no cost, to three years from the date of installation by completing online registration at www.cistermiser.co.uk/product-registration and completing and returning the commissioning checklist below.</p>
--	--

Product serial number

Installation address

No	Activity	Checked	Date
1.	Flush pipework prior to installation.	<input type="checkbox"/>	<input type="checkbox"/>
2.	Check valve orientation: valve should normally be mounted more than 150mm from spill over level of toilet pan.	<input type="checkbox"/>	<input type="checkbox"/>
3.	Install an isolation valve upstream of solenoid valve.	<input type="checkbox"/>	<input type="checkbox"/>
4.	Check all connections for leaks.		
5.	Ensure water supply pressure is above 2 bar dynamic, to give a minimum of 90 litres per minute at valve entry.	<input type="checkbox"/>	<input type="checkbox"/>
6.	Check sensor is mounted in correct position for type of sensor. (See installation instructions)	<input type="checkbox"/>	<input type="checkbox"/>
7.	Ensure label is removed from sensor before connecting power.	<input type="checkbox"/>	<input type="checkbox"/>
8.	Check electrical connections: To the solenoid orange to orange, blue to blue. Ensure either mains or battery power or multi product power supply is connected.	<input type="checkbox"/>	<input type="checkbox"/>
9.	Check operation: adjust sensor range and flush time if necessary.	<input type="checkbox"/>	<input type="checkbox"/>
10.	Test operation.	<input type="checkbox"/>	<input type="checkbox"/>
a	Wave: Place hand within 10 cm of sensor for 1 second valve will part flush; sensor will flash once per second. Place hand within 10cm of sensor for 2 seconds valve will full flush, sensor will flash twice per second.	<input type="checkbox"/>	<input type="checkbox"/>
b	Walkaway: If presence is detected sensor flashes green once every 3 seconds. Sensor detects a presence for less than 40 seconds, valve will part flush. Sensor detects a presence for over 40 seconds valve will full flush.	<input type="checkbox"/>	<input type="checkbox"/>

Cistermiser range

Urinal flushing

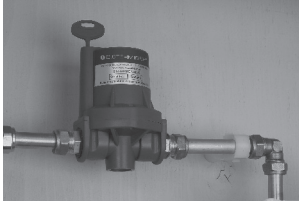

Hydraulic Valve

An automatic urinal flush control valve which reduces water consumption. The valve uses a simple patented mechanism which prevents water waste by ensuring that the auto-flush cistern is only filled, and can only flush, when the washroom is used.



Infrared Control (IRC) Valve

This valve automatically manages the water supply to the urinal cistern and reduces water consumption by up to 80%. The PIR sensor detects movement and activates the solenoid valve, allowing water into a urinal cistern.



Direct Flush Valve

An infrared sensor controlled urinal valve. It automatically flushes individual urinals after use, ensuring the highest level of hygiene from the minimum volume of water.

WC flushing



Easyflush Wave

An infrared, hands-free and water-conserving WC cistern flush valve suitable for concealed or exposed cisterns. Easy to install in retrofits or new installations, its no-touch dual flush WC cistern valve promotes water economy and hygiene in domestic and commercial washrooms.



Easyflush Walkaway

An infrared controlled automatic WC cistern flush valve that is suitable for concealed cisterns. The valve flushes once the user exits the cubicle. Ideal for use in environments where hygiene and water economy are concerns.



Easyflush Direct

An infrared electronic flushing system that removes the need for a WC cistern by taking its water feed straight from the mains supply. Ideal for high traffic areas as the system allows for a second flush without a delay.

Infrared Taps



Novatap

A contemporary deck-mounted chrome tap. The infrared control reduces water and energy usage and eliminates the risk that the tap may be left running. Internal and external valve installation options.



Vectatap

An elegantly designed infrared tap with the benefit of hygienic hands-free operation. Vectatap improves water and energy efficiency and includes auto-shut off and hygiene flush features.

Washroom control systems



Anti-Vandal Range

Our specialist vandal-resistant range of touch-activated washroom controls; for use in high risk or demanding public environments.



Sensazone

An innovative system to conserve water and energy. Occupancy is monitored by sensors; when someone enters the washroom all services controlled by Sensazone are activated – the hot and cold water, lighting and extractor fans.

Davidson Holdings' brands

Salamander Pumps



Salamander is one of the UK's leading manufacturers of pumps for boosting water pressure for showers, bathrooms and whole house supply in domestic and small commercial tank-fed systems.

www.salamanderpumps.co.uk



Keraflo manufacture delayed action float valves, which provide an accurate and effective method of controlling the level of stored cold water in tanks both with and without raised float valve chambers. The range is used in domestic, commercial and industrial applications worldwide.

www.keraflo.co.uk



Homeboost is an intelligent pump from Salamander Pumps that recognises when water flow is less than 12 ltrs/min and automatically boosts the performance of the incoming mains water up to 12 ltrs/min.

www.home-boost.co.uk

PENDOCK

Pendock manufacture solutions to the challenges of enclosing structures and perimeter casings for building interiors. The range includes pipe boxing, column and HVAC casings, radiator covers and washroom cubicles.

www.pendock.co.uk



Talon is the UK market leader in the manufacture and supply of plastic pipe clips, pipe collars and fixing plugs, plus a range of cover profiles for concealing pipework.

www.talon.co.uk



Combimate is a domestic limescale prevention device that prevents limescale build-up and soft water corrosion in combination boilers and other domestic hot water appliances.

www.combimate.co.uk



Fuelstop TFV is an overheat protection device that shuts off supply to fuel burning appliances. The FuelStop TFV complies with British safety standards and, unlike other fire valves, it is filled with liquid not gas, reducing nuisance trips.

www.fuelstop.co.uk

Cistermiser Limited

Unit 1, Woodley Park Estate, 59-69 Reading Road, Woodley, Reading, Berkshire RG5 3AN
t: +44 (0) 118 969 1611 f: +44 (0) 118 944 1426
e: sales@cistermiser.co.uk www.cistermiser.co.uk