

# TOWEL RAILS

**CLOAKROOM**  
SOLUTIONS



Durable and easy to care for.  
Including mounting material  
for wall screwing.

## TOWEL RAILS G-SERIES

The towel rails of the G series are bent by hand from one piece. Towel rail  $\varnothing 12$  mm for wall screwing. Distance to wall 62 mm (axis dimension). Solid stainless steel, hand-polished to a satin finish.

Also available in custom sizes.

<b>HS12-400G</b>	Overall length 42,5 cm.
<b>HS12-500G</b>	Overall length 52,5 cm.
<b>HS12-600G</b>	Overall length 62,5 cm.
<b>HS12-700G</b>	Overall length 72,5 cm.
<b>HS12-800G</b>	Overall length 82,5 cm.
<b>HS12-900G</b>	Overall length 92,5 cm.
<b>HS12-1000G</b>	Overall length 102,5 cm.
<b>HS12-1200G</b>	Overall length 122,5 cm.

Product example  
HS12-800G Detail view:

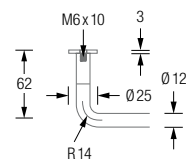

Product example HS12-800G Plan view:

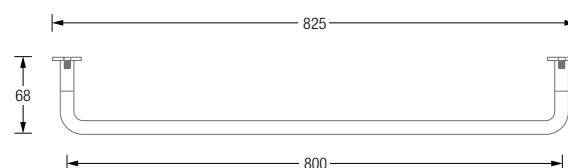



G-SERIES ADHESIVE MOUNT TOWEL BAR

Durable and easy to care for.  
Including mounting material  
for wall bonding.

## TOWEL RAILS

### G-SERIES ADHESIVE MOUNT

The towel rails of the G series are bent by hand from one piece. Towel rail  $\varnothing 12$  mm with Tesa® Power.Kit set for wall mounting. Distance to wall 65 mm (axis dimension). Solid stainless steel, hand-polished to a satin finish.  
Also available in custom sizes.

<b>HS12-400G-K55</b>	Overall length 45,5 cm.
<b>HS12-500G-K55</b>	Overall length 55,5 cm.
<b>HS12-600G-K55</b>	Overall length 65,5 cm.
<b>HS12-700G-K55</b>	Overall length 75,5 cm.
<b>HS12-800G-K55</b>	Overall length 85,5 cm.
<b>HS12-900G-K55</b>	Overall length 95,5 cm.
<b>HS12-1000G-K55</b>	Overall length 105,5 cm.
<b>HS12-1200G-K55</b>	Overall length 125,5 cm.

Product example  
HS12-800G-K55 Detail view:

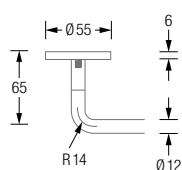

Product example HS12-800G-K55 Plan view:

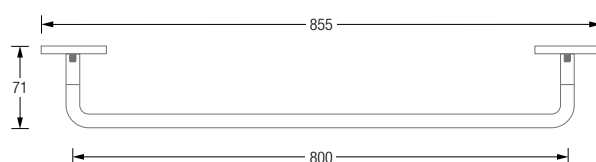



TOWEL RAILS G SERIES  
SHOWER CURTAIN RAIL DSE900  
SHOWER TRAYS DAE230

## TOWEL RAIL E-SERIES

Including mounting material for wall screwing.

## TOWEL RAILS E-SERIES

The elegant E-Series towel rails feature concealed rail attachments. Towel rail  $\varnothing$  12 mm for wall screwing. Distance to wall 69 mm (axis dimension). Solid stainless steel, hand-polished to a satin finish.

Also available in custom sizes.

<b>HS20-80E400</b>	Overall length 42,5 cm.
<b>HS20-80E500</b>	Overall length 52,5 cm.
<b>HS20-80E600</b>	Overall length 62,5 cm.
<b>HS20-80E700</b>	Overall length 72,5 cm.
<b>HS20-80E800</b>	Overall length 82,5 cm.
<b>HS20-80E900</b>	Overall length 92,5 cm.
<b>HS20-80E1000</b>	Overall length 102,5 cm.
<b>HS20-80E1200</b>	Overall length 122,5 cm.

Product example  
HS20-80E800 Detail view:

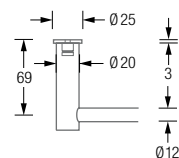

Product example HS20-80E800 Plan view:

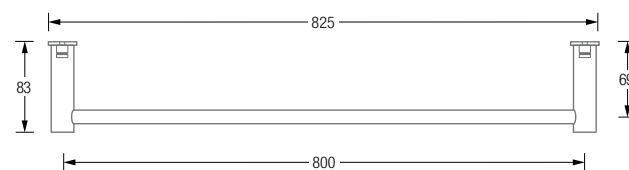

Installation with hat rosette R25H:

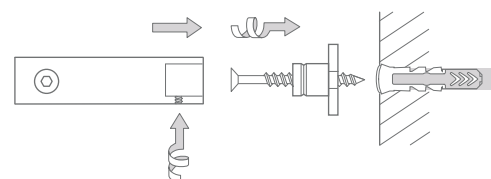

## E-SERIES ADHESIVE MOUNT TOWEL RAIL

Durable and easy to care for.  
Including mounting material  
for wall bonding.

## TOWEL RAILS

### E-SERIES ADHESIVE MOUNT

The elegant E-Series towel rails feature concealed rail attachments. Towel rail  $\varnothing$  12 mm with Tesa® Power.Kit set for wall mounting. Distance to wall 72 mm (axis dimension). Solid stainless steel, hand-polished to a satin finish. Also available in custom sizes.

<b>HS20-80E400-K55</b>	Overall length 45,5 cm.
<b>HS20-80E500-K55</b>	Overall length 55,5 cm.
<b>HS20-80E600-K55</b>	Overall length 65,5 cm.
<b>HS20-80E700-K55</b>	Overall length 75,5 cm.
<b>HS20-80E800-K55</b>	Overall length 85,5 cm.
<b>HS20-80E900-K55</b>	Overall length 95,5 cm.
<b>HS20-80E1000-K55</b>	Overall length 105,5 cm.
<b>HS20-80E1200-K55</b>	Overall length 125,5 cm.

Product example  
HS20-80E800-K55 Detail view:

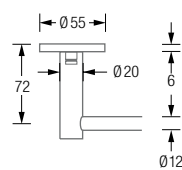

Product example HS20-80E800-K55 Plan view:

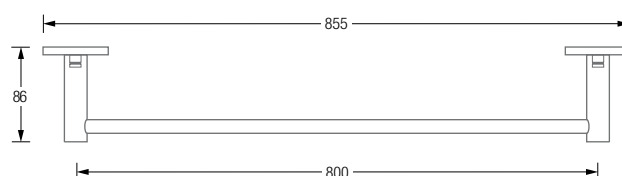

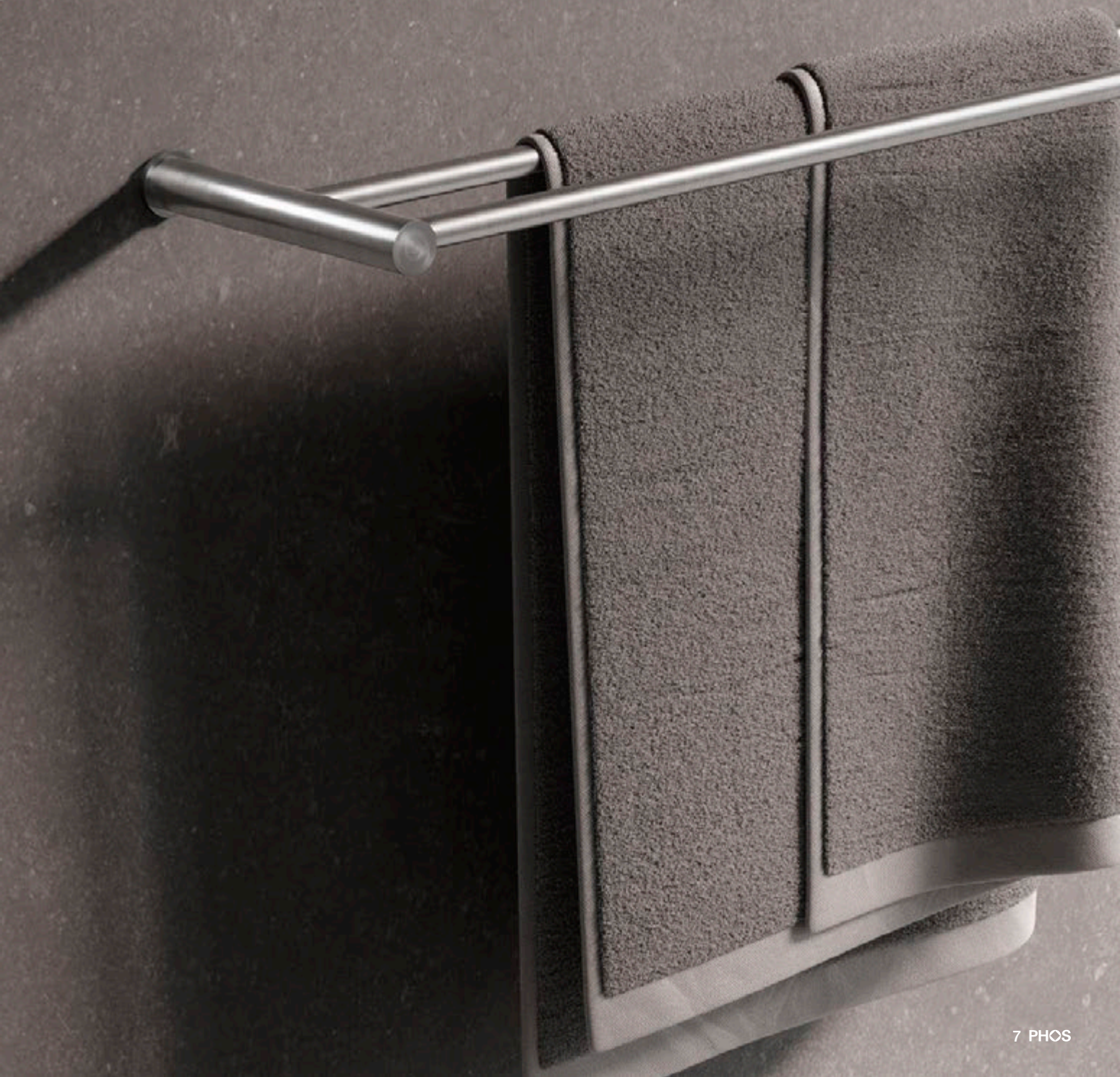



TOWEL RAIL E-SERIES DOUBLE

Including mounting material for wall screwing.

## TOWEL RAILS E-SERIES DOUBLE

The elegant E-Series double towel rails feature concealed rail attachments. Two towel rails  $\varnothing$  12 mm for wall screwing. Wall distance 66 or 129 mm (axis dimensions). Solid stainless steel, hand-polished to a satin finish.

Also available in custom sizes.

<b>HS20-140ED400</b>	Overall length 42,5 cm.
<b>HS20-140ED500</b>	Overall length 52,5 cm.
<b>HS20-140ED600</b>	Overall length 62,5 cm.
<b>HS20-140ED700</b>	Overall length 72,5 cm.
<b>HS20-140ED800</b>	Overall length 82,5 cm.
<b>HS20-140ED900</b>	Overall length 92,5 cm.
<b>HS20-140ED1000</b>	Overall length 102,5 cm.
<b>HS20-140ED1200</b>	Overall length 122,5 cm.

Product example  
HS20-140ED800 Detail view:

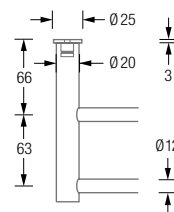

Product example HS20-140ED800 Plan view:

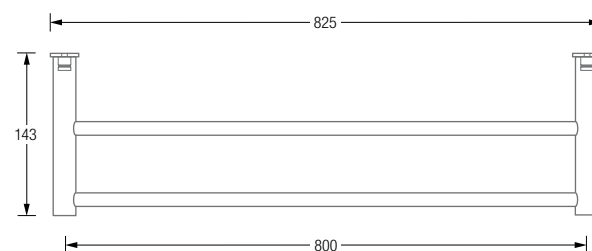



## TOWEL RAIL D-SERIES

Including mounting material for wall fixing.

## TOWEL RAILS D-SERIES

The high-quality and stylish D-Series towel rails feature two detachable rod holders, which allows flexible positioning of the mounting points. Continuous towel rail  $\varnothing$  12 mm for wall screwing. Distance to wall 69 mm (axis dimension). Solid stainless steel, hand-polished to a satin finish. Also available in custom sizes.

<b>HS20-80-400</b>	Overall length 40 cm.
<b>HS20-80-500</b>	Overall length 50 cm.
<b>HS20-80-600</b>	Overall length 60 cm.
<b>HS20-80-700</b>	Overall length 70 cm.
<b>HS20-80-800</b>	Overall length 80 cm.
<b>HS20-80-900</b>	Overall length 90 cm.
<b>HS20-80-1000</b>	Overall length 100 cm.
<b>HS20-80-1200</b>	Overall length 120 cm.

Product example  
HS20-80-800 Detail view:

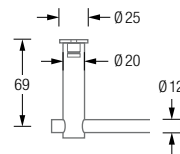

Product example HS20-80-800 Plan view:

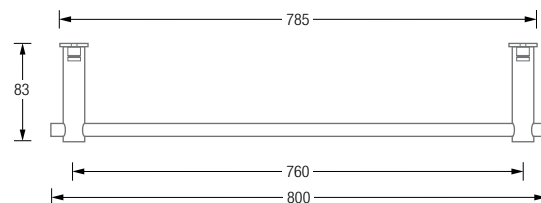



D-SERIES ADHESIVE MOUNT TOWEL RAIL

Durable and easy to care for.  
Including mounting material  
for wall bonding.

## TOWEL RAILS

### D-SERIES ADHESIVE MOUNTED

The high-quality and stylish D-Series towel rails feature two detachable rod holders, which allows flexible positioning of the mounting points. End-to-end towel rail  $\varnothing$  12 mm with Tesa® Power.Kit set for wall gluing, wall distance 72 mm (axis dimension). Solid stainless steel, hand-polished to a satin finish.

Also available in custom sizes.

<b>HS20-80-400-K55</b>	Overall length 45,5 cm.
<b>HS20-80-500-K55</b>	Overall length 55,5 cm.
<b>HS20-80-600-K55</b>	Overall length 65,5 cm.
<b>HS20-80-700-K55</b>	Overall length 75,5 cm.
<b>HS20-80-800-K55</b>	Overall length 85,5 cm.
<b>HS20-80-900-K55</b>	Overall length 95,5 cm.
<b>HS20-80-1000-K55</b>	Overall length 105,5 cm.
<b>HS20-80-1200-K55</b>	Overall length 125,5 cm.

Product example  
HS20-80-800-K55 Detail view:

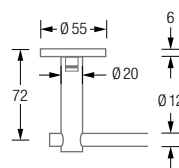

Product example HS20-80-800-K55 Plan view:

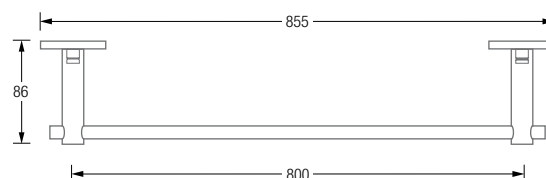

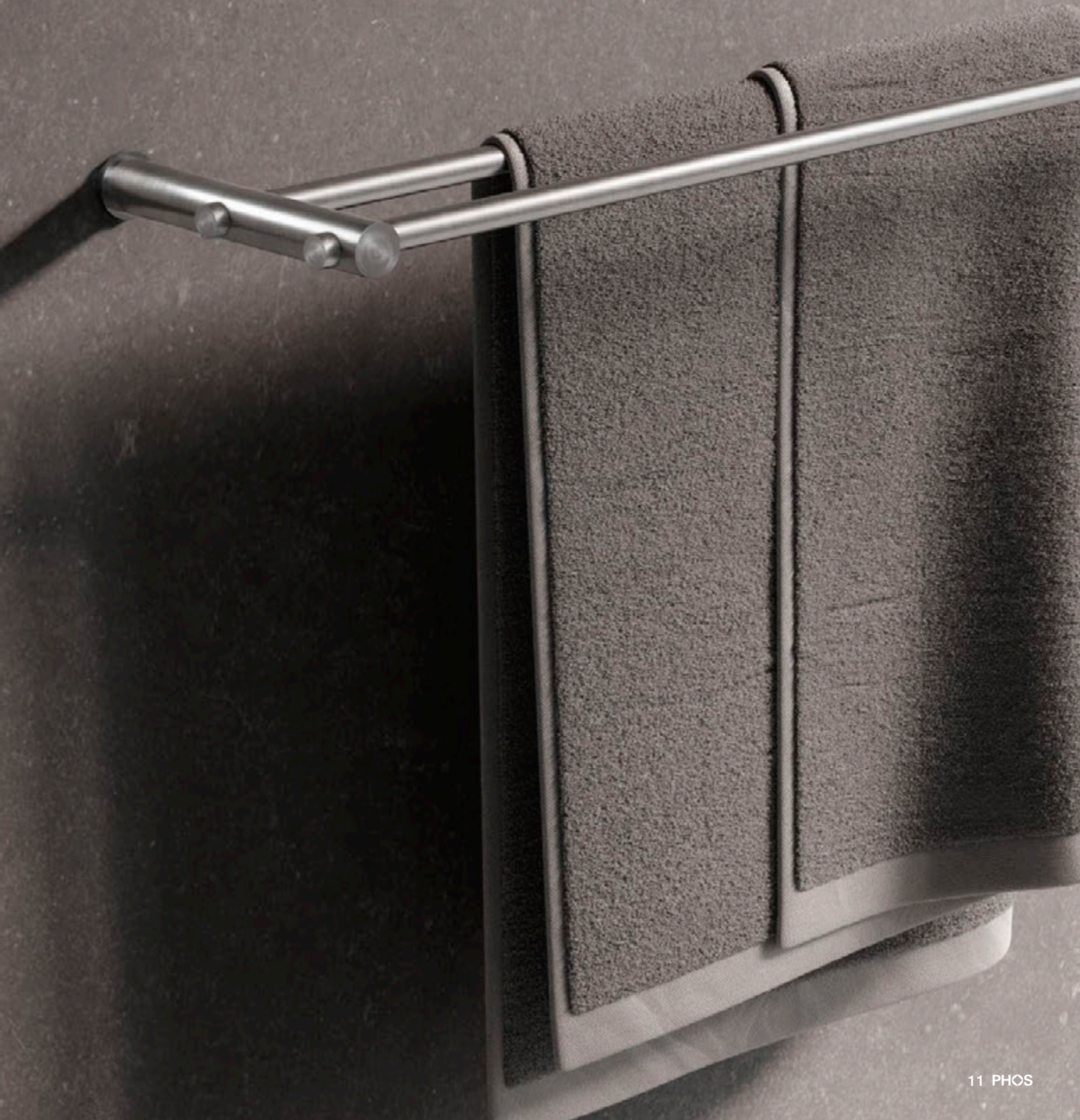

TOWEL RAIL **D-SERIE** DOUBLE

Including mounting material for wall fixing.

## TOWEL RAILS D-SERIE DOUBLE

High quality and stylish, the D-Series double towel rails feature two detachable rail holders, allowing for flexible positioning of the mounting points. Two continuous towel rails  $\varnothing$  12 mm for wall screwing.

Wall distance 66 or 129 mm (axis dimensions). Solid stainless steel, hand-polished to a satin finish.

Also available in custom sizes.

<b>HS20-140D400</b>	Overall length 40 cm.
<b>HS20-140D500</b>	Overall length 50 cm.
<b>HS20-140D600</b>	Overall length 60 cm.
<b>HS20-140D700</b>	Overall length 70 cm.
<b>HS20-140D800</b>	Overall length 80 cm.
<b>HS20-140D900</b>	Overall length 90 cm.
<b>HS20-140D1000</b>	Overall length 100 cm.
<b>HS20-140D1200</b>	Overall length 120 cm.

Product example  
HS20-140D800 Detail view:

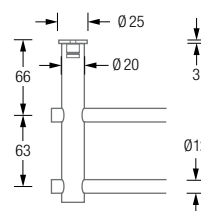

Product example HS20-140D800 Plan view:

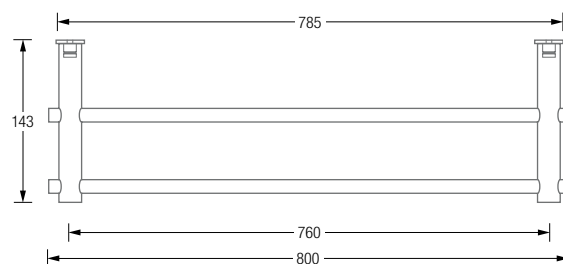





TOWEL RAIL T-SERIE

Including mounting material for wall fixing.

## TOWEL RAILS D-SERIES DOUBLE

The elegant and solid towel rails of the T series offer a clear design. Towel rail  $\varnothing$  20 mm for wall screwing. Distance to wall 80 mm (axis dimension). Solid stainless steel, hand-polished to a satin finish. Also available in custom sizes.

- HS18-400T** Overall length 40 cm.
- HS18-500T** Overall length 50 cm.
- HS18-600T** Overall length 60 cm.
- HS18-700T** Overall length 70 cm.
- HS18-800T** Overall length 80 cm.
- HS18-900T** Overall length 90 cm.
- HS18-1000T** Overall length 100 cm.
- HS18-1200T** Overall length 120 cm.

Product example  
HS18-800T Detail view:

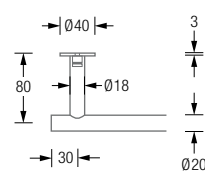

Product example HS18-800T Plan view:

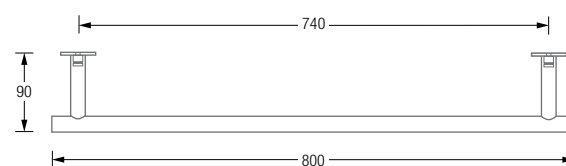

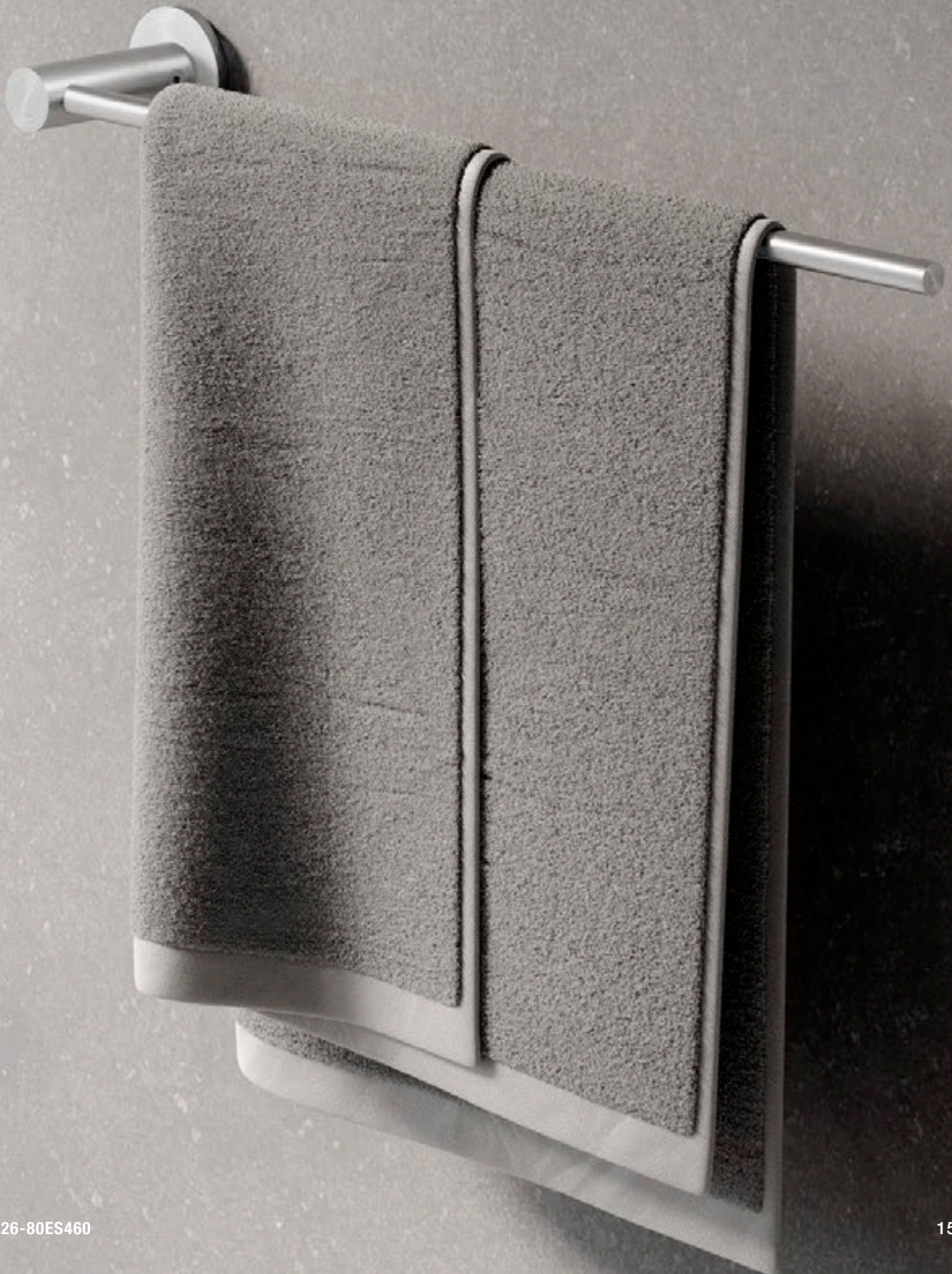

TOWEL RAIL HS26-140EDS460



## TOWEL RAILS

### OPEN ON ONE SIDE

Towel holders open on one side, with one or two arms. Towel rail/s  $\varnothing$  12 mm, axis length 46 cm, total length 49 cm. For wall screwing. Solid stainless steel, hand-polished to a satin finish.

**HS26-80ES460**

Single towel holder, distance to wall 70 mm (axis dimension).

**HS26-140EDS460**

Double towel rail, wall distance 67 or 130 mm (axis dimensions).

Including mounting material for wall fixing.

Mounting with rosette R60M6:

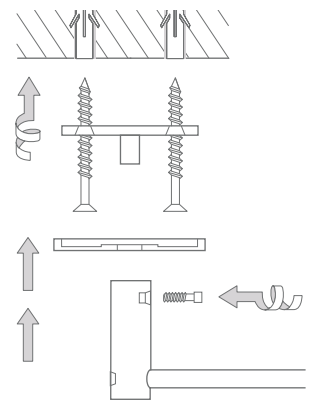

HS26-80ES460 Plan view:

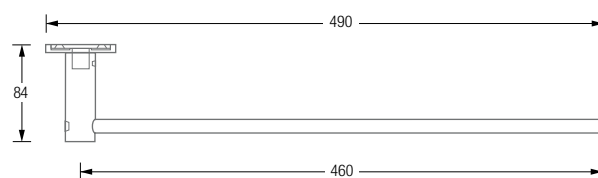

HS26-80ES460 Detail view:

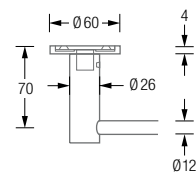

HS26-140EDS460 Plan view:

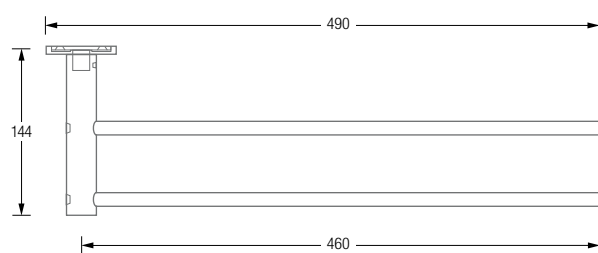

HS26-140EDS460 Detail view:

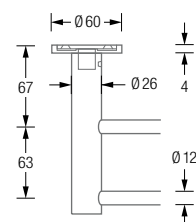







TOWEL RAIL HS12-420D-0

## TOWEL RAIL OPEN ON ONE SIDE

Towel holders open on one side with one or two fixed holding arms. Towel rail/s  $\varnothing$  12 mm for wall screwing. Solid stainless steel, hand-polished to a satin finish.

- HS12-420** With a holding arm.
- HS12-420-0** With a holding arm and O-ring\*
- HS12-420D** With two holding arms.
- HS12-420D-0** With two holding arms and O-rings\*

Product example HS12-420-0 Plan view:

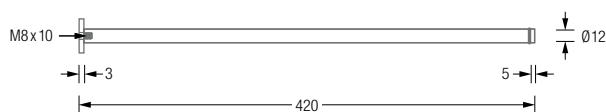

Product example HS12-420-0 Front view:



Product example HS12-420D-0 Plan view:

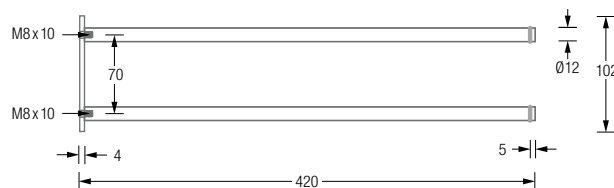

Product example HS12-420D-0 Front view:

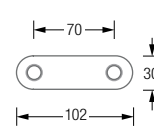

Including mounting material.

Installation with hanger bolt and rosette:

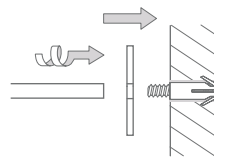

\* Material: Viton®. High chemical and thermal resistance.

Manufactured from fluorine and rubber. ISO abbreviation: FKM, DIN abbreviation: FPM.



## SWIVEL TOWEL RAIL GHH1

Including mounting material for wall screwing.

## TOWEL RAIL ADJUSTABLE

Elegant and simple towel holder with one or two swiveling towel rails  $\varnothing$  12 mm with O-ring\*. For wall screwing. Solid stainless steel, hand-polished to a satin finish.

- GHH1** With a swiveling rail  
**GHH2** With two swiveling rails.

GHH1 Side view:

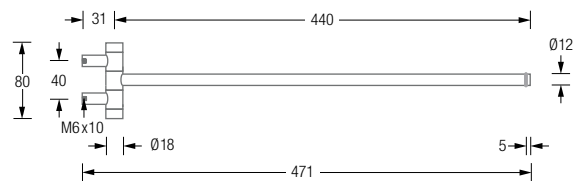

GHH2 Side view:

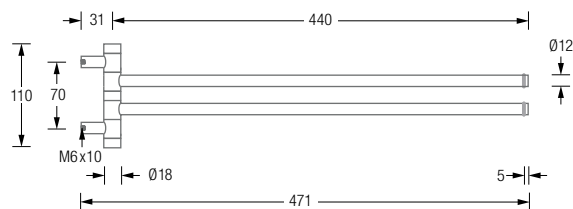

\* Material: Viton®. High chemical and thermal resistance.  
Manufactured from fluorine and rubber. ISO abbreviation: FKM, DIN abbreviation: FPM.



SWIVELING TOWEL RAIL **GHH2**  
MOBILE COAT RAIL **GW1-BPW**  
COAT HANGER **KB2**





T0-B

## CEILING TOWEL RAILS TAKE 0

Towel rail Take 0 for concealed ceiling mounting.

Towel rail  $\varnothing$  18 mm. Solid stainless steel, hand-polished to a satin finish. Standard size for 2.50 m ceiling heights.

Also available in custom sizes.

**T0-B** Without shelf.

**TOG-B** With a glass shelf made of 6 mm ESG (toughened safety glass, satined underside) with polished edges. Including two glass shelf supports, freely positionable in height.

Including mounting material for concealed ceiling mounting.

Installation with ceiling bracket DL12:

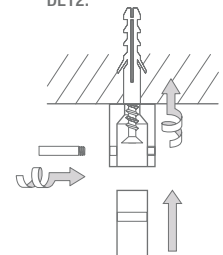

T0-B Front view:

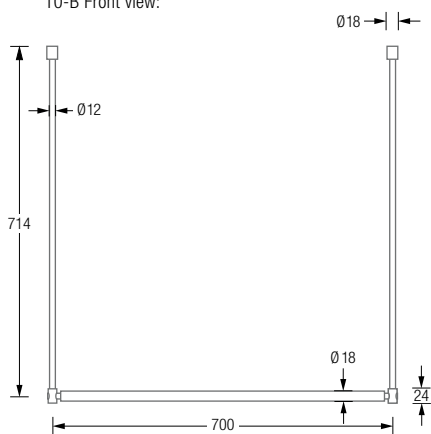

TOG-B Front view:

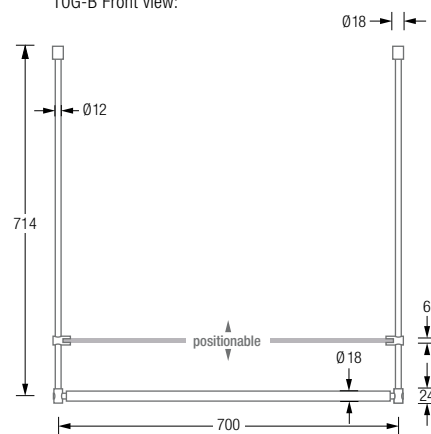

TOG-B Plan view:

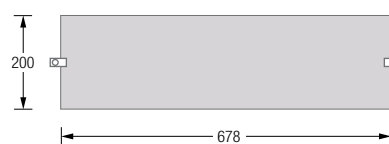





## CEILING TOWEL RAIL

### TAKE 3 AND TAKE 5

Ceiling towel rail with three or five hooks that can be rotated through 360°. For concealed ceiling mounting. Solid stainless steel, hand-polished to a satin finish. Standard size for 2.50 m ceiling heights. Also available in custom sizes.

**T3-B** Take 3, with three rotating hooks .

**T5-B** Take 5, with five rotating hooks.



Including mounting material for concealed ceiling screws.



Object of the permanent exhibition of the Chicago Athenaeum: Museum of Architecture and Design. Good Design Award 2002 - The Chicago Athenaeum. Design: Andreas Winkler.

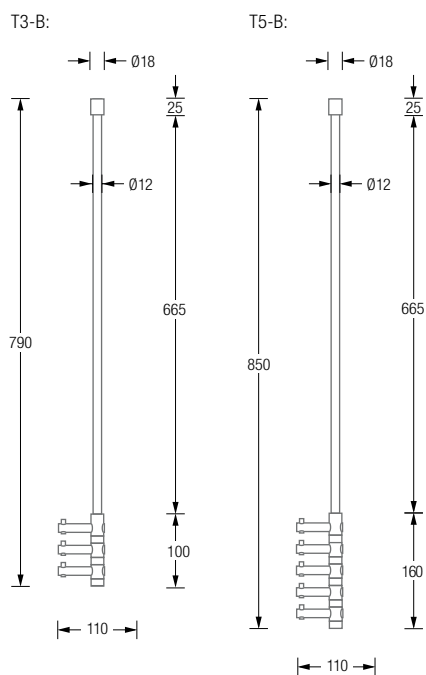

Installation with ceiling bracket DL12:

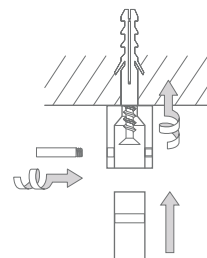



CLOAKROOM SOLUTIONS LTD  
info@cloakroomsolutions.co.uk  
020 3011 1014  
cloakroomsolutions.co.uk