

**Intercall 600 & Intercall 700  
Installation & Operation Guide  
Documentation Issue 4.32  
[www.intercall.co.uk](http://www.intercall.co.uk)**



# Index

## Introduction to Intercall

	<b>Page</b>
Introduction & Intercall 600 & 700 Inter-compatibility.....	3
Guide to Intercall 600.....	4
Guide to Intercall 700.....	5
Ordering Information.....	7
Specials order codes and obsolete order codes.....	8

## User Guide

Intercall 600 Call Points.....	9
Intercall 600 Display Unit.....	10
Intercall 700 Audio Call Point.....	11
Intercall 700 Audio Display Unit.....	12
Intercall 768 Audio Room Communicator.....	15
Intercall 700 Call / Display Unit, Overdoor Lights & Other devices.....	16

## Installation Guide

System Concepts & Network Cable Requirements.....	17
Planning an Installation.....	18
Using the FJB to split the load.....	20
First Fix.....	21
Second Fix.....	23
System Tests.....	24
L747 Installation Procedures.....	26

## Intercall Components & Network Devices

L617 and L717 Power Supply Controller.....	29
L7717 Large Power Supply Controller.....	30
L622 Intercall 600 Standard Call Point.....	31
L622AN310 Intercall 600 Call Point with extended Inputs & Outputs....	32
L733 Door Monitoring & Access Control Point.....	33
L737 Booster Power Supply.....	34
L628 600 Series LCD Display.....	35
L748 Large Corridor LED Display.....	36
L746 Overdoor Light.....	37
L747 Universal Interface.....	38
Alphanumeric Paging.....	39
RB1 Relay Board.....	40
L714 Remote Sounder with Relay.....	41
DPU414 Thermal Printer.....	42
FJB2 Fused Junction Board.....	43
L758 Audio LCD Display.....	44
L722 Call Point.....	45
L634 Network Input/Output Module.....	46
L752 Audio Call Point.....	47
L762 Audio Call/Display Unit.....	48
L768 Room Communicator Unit.....	49
CMS Lite Call Management Software for Windows.....	50

TIR4 Infra Red Trigger.....	51
LIMKIT System Configuration Kit.....	52
SCP Slave Call Point.....	52
SRP Slave Reset / Present Point.....	54
CS1 Ceiling Pull Switch.....	55
PIR1 Passive Infra Red Detector (For Bed monitoring).....	56

## **Configuration Guide**

System Configuration.....	57
Display Menu Settings.....	59
L672 Dementia Controller Menu Settings.....	63
Zoning Configuration.....	64
Zoning Examples.....	66
Factory Text & Call Point Address Setting.....	72
Setting the User ID on the TIR4 Triggers.....	52
L617 / L717 System Configuration Switch Setting.....	74

## **Fault Finding Guide**

Call Point Faults.....	75
Display Unit Faults.....	76
Power Supply Faults.....	77
L747 Interface Faults.....	78
Network Faults: Data corruption / Volt Drop / Audio Faults.....	79

## Introduction to Intercall.

**INTERCALL** is one of the most advanced range of nurse call systems available today. They couple functionality with the most up to date reliable electronic technology available. Intercall have revolutionised nurse call by providing simple to install and operate systems, which are very competitively priced and out perform practically all other systems available today. Indeed the Intercall 600 system is the best selling nurse call system within the UK

Since the introduction of Intercall in 1988, we have made people aware that there can be a more flexible, more efficient, more effective way of using nurse call than ever before

This leaflet covers our two most advanced addressable call systems, the Intercall 600 and the Intercall 700. Both systems are so flexible, that from the smallest home to the largest hospital, we have a solution to your particular requirements. The systems may be completely re-configured, at any time, so now you can choose how to manage patient and staff call requirements and change them as you wish.

We recommend that you read the following pages as they describe how you can make the most of your Intercall Nurse call system.

## **Intercall 600 and 700 Inter-compatibility.**

Intercall 600 and Intercall 700 systems share several network devices. The following table highlights the inter-compatibility between the two systems.

Part No	Description	617 PSU	717 PSU	Network Cable	IR Receiver
<b>L622</b>	600 Series Non Audio Call Point (Mk2)	✓	✓*	2 wire	✗
<b>L722</b>	600/700 Series Non Audio call point with Infra Red	✓	✓	2 wire	✓
<b>L732</b>	600/700 Series Non Audio call point with IR + Aux	✓	✓	2 wire	✓
<b>L722DK</b>	600/700 Door Monitoring Point	✓	✓	2 wire	✗
<b>L617</b>	600 Series Master Power Supply	✓	✗	2 wire	✗
<b>L733</b>	600/700 Series Door Monitor & Access Control Point	✓	✓	2 wire	✗
<b>L717</b>	700 Series Master Power Supply	✗	✓	2 wire	✗
<b>L746</b>	600/700 Triangular Overdoor Light	✓	✓	2 wire	✗
<b>L746s</b>	As above with integral sounder	✓	✓	2 wire	✗
<b>L737</b>	600/700 Series Booster Power Supply	✓	✓	2 wire	✗
<b>L752</b>	700 Series Audio Call Point with Intercom	✗	✓	4 wire	✓
<b>L758</b>	700 Series Audio Display Unit with Intercom	✗	✓	4 wire	✗
<b>L762</b>	700 Series Audio Call / Display Unit with Intercom	✗	✓	4 wire	✓
<b>L768</b>	700 Series Room Communicator	✗	✓	4 wire	✗
<b>L628</b>	600 Series Display Unit (Mk2)	✓	✓*	2 wire	✗
<b>L634</b>	600/700 Series Network Input/Output Module	✓	✓	2 wire	✗
<b>L748</b>	700 Series Corridor LED Display Unit	✗	✓	2 wire	✗
<b>FJB2</b>	Fused Junction Board Unit (Mk2)	✓	✓	4 wire	✗
<b>L747</b>	600/700 Series Universal System Interface	✓	✓	2 wire	✗
<b>L714</b>	600/700 Series Remote Sounder	✓	✓	2 wire	✗
<b>PIR1</b>	Passive Infra Red Bed Monitor	✓	✓	2 wire	✗
<b>SCP</b>	Slave Call Point	✓	✓	-	✗
<b>SRP</b>	Slave Reset/Presence Point	✓	✓	-	✗
<b>RB1</b>	Relay Board	✓	✓	2 wire	✗

Due to the continued development programme on the Intercall range of products, please contact the sales office for the latest information.

\* Only applies to Mk2 products manufactured after August 2003

# A GUIDE TO INTERCALL 600

*Concepts of the simple to use, addressable call system*

The **INTERCALL 600** is our most popular addressable call system, coupling flexibility with ease of use, it provides a complete solution that out performs practically all other systems available today. Being an addressable system, it requires only one two core connection to network devices and operates at 12voltsDC. The room descriptions may be programmed using a PC compatible laptop computer or similar which can be programmed on or off site as required.

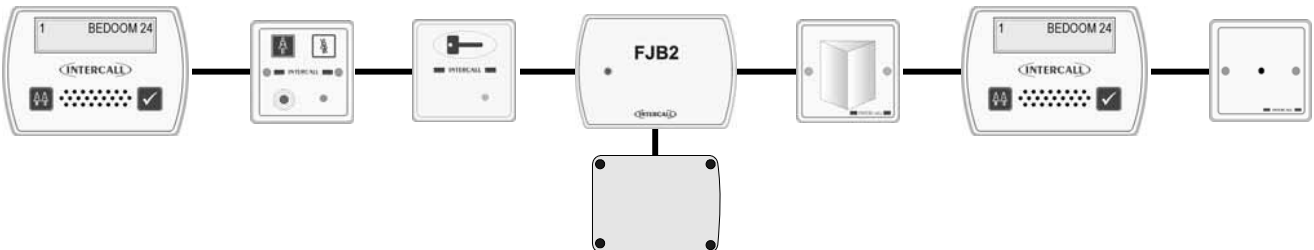

## L622 Standard Call Point.

A Call Point is required for every individual call location on the system. It features six levels of call, multi-colour re-assurance LED & 'call follower' sounder. The industry standard trigger socket will accept pear leads, pressure mats, portable radio triggers and a host of other triggering devices. Options which must be specified when ordering include: Magnetic Key reset (**L622M**) Emergency call only. Non-latching call points are available for telephones etc. *see pages 31 & 45*

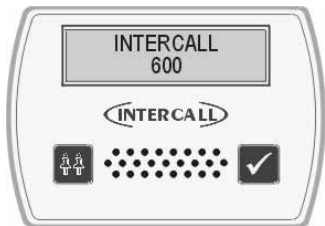

## L628 LCD Displays.

A Display Unit is required in every location where calls are to be shown and the alarm is to sound. It features LCD display with backlight, multi-level adjustable alarm, day/night volume control, 'Priority' alarm tone for specific call locations, configuration menus and an output which can be connected to trigger external equipment. All displays are identical but can be configured on site to operate independently. *see page 35*



## L733 Door Monitoring & Access Control Point.

Generally used to monitor fire doors and main entrances for unauthorised entry or exit. Token allows door to be opened by authorised personnel without sounding the alarm and isolated to allow the door to be left open if required. Supplied with two magnetic tokens. *See page 33*



## SCP Slave Call Point.

Slave call points are used to cover several beds in one room or ward where each individual bed does not require a separate identity on the call system. Units must be wired back to a standard call point to provide the reset and to generate the call identity. *see page 52*



## L746 Overdoor Light.

Overdoor lights are an optional item normally positioned above the door in a corridor to indicate the status of the call point(s) within the room. The **L746** can be used to monitor several call point addresses and are ideal for 'end of corridor' indication. The **L746S** Unit is fitted with an integral sounder. *see page 37*

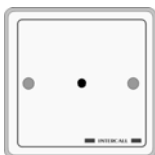

## L714 Remote Sounder with relay.

Remote Sounders are used in areas where only an audible alarm is required. The sounder is similar in operation to the L628 with limited zoning facilities. Any assistance or emergency call on the system will over-ride the standard call tone. The unit is fitted with a relay which provides N.O and N.C 'dry' contacts. *see page 41*

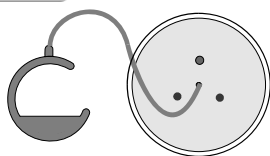

**CS1 Ceiling Pull Switch**  
Connects to call point for en-suite rooms and bathrooms/toilets *See Page 55*

**L717 & L737 Power Supply & FJB2**  
Provides power for system & holds back up battery. Laptop connects to L717 to configure system. L737 is a booster PSU required for larger systems *See Page 31*

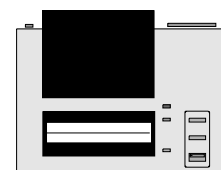
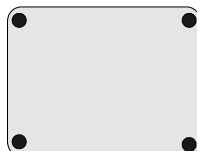

**Printers and alphanumeric pagers**  
Printers and alphanumeric pagers may be connected to the system with the L747 universal interface. *See Page 36*

# A GUIDE TO INTERCALL 700

*Concepts of the advanced call system with intercom*

The **INTERCALL 700** is the latest innovation in the Intercall range of advanced call systems. The system boasts all the features of the Intercall 600 system together with hands free two way speech facilities between all audio units. All room call points have an integral infra red receiver which allows a call to be generated away from the call point without the need for trailing wires. Using an infra red trigger TIR4, it is possible to identify the calling resident together with their location which can be used to route the call to specific members of staff. The system is fully addressable and only requires connection to a common 12v network cable. The system is configured using a PC compatible computer or similar & may be programmed on or off site as required.

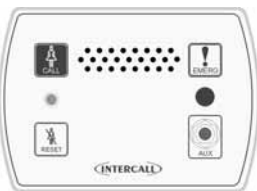
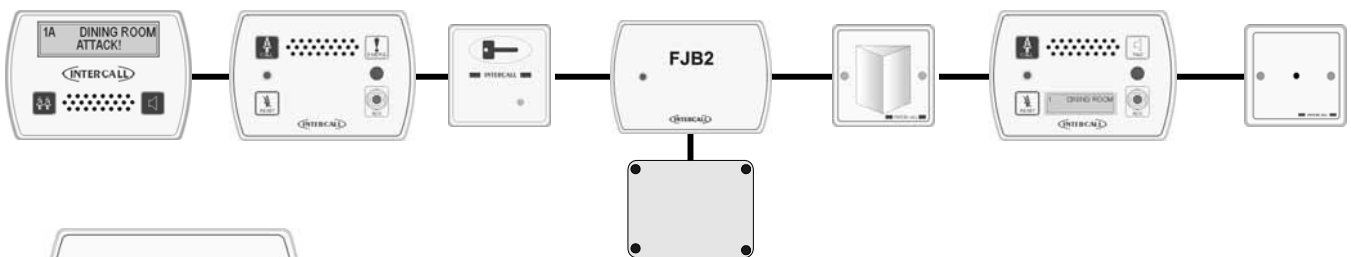

## L752 Audio Call Point.

An L752 is required for every individual audio call location on the system. It features 7 levels of call, hands free two way intercom, integral infra red receiver, audio page facility, re-assurance LED & 'call waiting' sounder. The industry standard jack socket will accept a host of triggering devices. The unit may be flush or surface mounted using the Intercall **BB1** backbox. *See page 47*



## L758 Audio Display Unit.

Audio display units are generally located throughout the establishment and provide description of the call type, location and identity of caller together with sounding the integral alarm. It features 2 line back-lit display, multi function audible alarm, two way intercom facility and audio page facility to all other displays and to all members of staff present within a residents bedroom. *see page 44*



## L762 Call/Display Unit

The L762 combines the features of the speech call point with a built in display. When in staff present mode the unit will display all calls on the system in full alphanumeric text, enabling staff to see & speak to other callers elsewhere on the system without having to leave their patient. *see page 48*



## L722 Non Audio Call Point.

The L722 Call Point contains identical features to the audio call point described above without the intercom. Options which must be specified when ordering include: emergency call only & non-latching operation for telephone ring detectors etc.



## TIR4 Infra Red Trigger.

The infra red trigger is worn by residents and allows access to the call system at all times. It will trigger any Intercall 700 series call point within range and can be configured to generate different levels of call. Each trigger is assigned a unique number which may be programmed into the system to identify the calling resident by name. *see page 51*



## Intercall CMS Lite Software.

With the addition of the powerful Call Management Software, the Intercall 600/700 system becomes the complete solution to resident care. Running on any PC compatible computer under Windows™ 2000/XP, it provides residents database, management reporting and system control functions, in addition, the PC can be connected to a pager transmitter and manage calls to staff alphanumeric pagers. *see page 50*

# INTERCALL ACCESSORIES

*Accessories to enhance your Intercall system*

All **INTERCALL** systems can be enhanced with the use of accessories which allows the system to be used by patients with virtually any level of disability. The following list details a few of the most popular accessories with their application and part numbers. In addition to the standard range of accessories, we also manufacture bespoke accessories to suit a particular requirement, please contact your supplier for more information.



## **NP2 & NP4 Pear Leads.**

Our attractively styled pear leads allow access to the call system when residents are away from the call point. The lead is available in 2Metre and 4 Metre lengths and the right angle jack plug means that the plug is less likely to be damaged by furniture movement. All pear leads are fitted with a clip fastener, which allows the unit to be attached to clothing or bed sheets if required.



## **S2 Water Resistant Air Switches.**

For bathroom / shower applications, the **S2** Air Switch is ideal, being totally sealed and safe as it uses air to trigger the call. The unit is supplied with 2metres of air pipe which is then plugged into the front of any Intercall call point. The unit is fitted with a clip fastener, which allows the unit to be attached to clothing or bed sheets if required. All call points generate a standard call should the pear lead be removed from the jack socket.

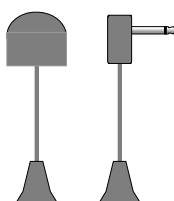

## **PS1 Plug In Pull Cord.**

The PS1 converts a normal call point into a unit which may be activated by pull string. The unit plugs into the jack socket and has a 30cm cord terminated with a 'pull' which allows the call point to be activated by simply pulling gently on the 'pull'. This is ideal in toilets where a ceiling pull switch has not been fitted or where is it out of reach.

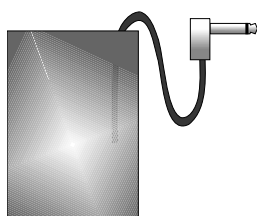

## **PM1 Pressure Mat.**

The PM1 is a standard pressure mat which plugs into the call point jack socket and activates a standard call when pressure is applied to the mat. The unit should be placed under a mat or carpet as it is not designed to be walked on directly. The unit comes supplied with a four metre lead terminated with a right angle jack plug. The surface area of the mat measures 300 x 600 mm.



## **BC1 Breath Switch.**

The breath switch allows even the most severely handicapped access to the call system. It operates in a similar way to the pear leads and air switches, generating a standard call, and plugs into the jack on all call points. It is supplied with detachable mouth - pieces, which may be sterilised.

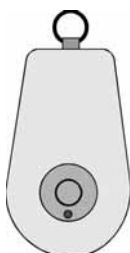

## **TIR4 Infra Red Trigger.**

The TIR4 allows a call point to be activated remotely, and has the advantage of triggering a local call anywhere in the home (Infra Red Call Points only). This enables carers to identify the location of the resident instantly. Competitors' radio signals pass through walls so while it is possible to know who requires assistance it is not possible to pinpoint their exact location from the call system. The TIR4 requires infra red call points to receive the signals, these are available on the Intercall 600 and 700 systems. Using the TIR4 with an Intercall 700 system, it is possible to identify the calling resident and call location.



## Ordering Information

<b>L617</b>	600 Series Master Power Supply Unit.
<b>L628</b>	600 Series LCD Display Unit. (See Note 3)
<b>L622</b>	600 Series Standard Call Point.
<b>L622M</b>	600 Series Call Point with magnetic reset. (See Note 2)
<b>L717</b>	600/700 Series Master Power Supply Unit.
<b>L752</b>	700 Series Call Point with IR receiver and intercom facility. (See Note 3)
<b>L762</b>	700 Series Call/Display Unit as L752 with LCD unit. (See Note 3)
<b>L758</b>	700 Series LCD Display Unit with intercom facility. (See Note 3)
<b>L768</b>	700 Series Room Communicator.
<b>L748</b>	700 Series Corridor LED Display with 100mm characters.
<b>L722</b>	600/700 Series Non Audio Call Point with integral infra red receiver.
<b>L732</b>	600/700 Series Non Audio Call Point with integral infra red receiver.
<b>L733</b>	600/700 Series Door Monitoring & Access Control
<b>L746</b>	600/700 Series Two Colour Group Overdoor Light
<b>L746S</b>	600/700 Series Two Colour Group Overdoor Light with sounder
<b>L737</b>	500/600/700 Series Universal Booster Power Supply
<b>L747</b>	600/700 Series Universal Interface. (Operates with DPU414 or RFTX)
<b>L714</b>	600/700 Series Remote Sounder and relay output board

## Optional Accessories

<b>CS1</b>	Ceiling Pull Switch with twin LED's
<b>LBAT</b>	12V 1.9Ah Battery for Power Supplies (L617/L717/L737)
<b>LIMKIT</b>	600 / 700 Series System Configuration Kit including software.
<b>CMSL</b>	CMS Lite Call Management Software for Intercall 600/700 Windows 2000/XP
<b>SW1</b>	Day / Night Switch - Connects to L617/L717
<b>TIR4</b>	Pendant Infra Red Trigger (Used with L722/L752/L762)
<b>RFTX</b>	Scope Paging Transmitter & 1 Pager (Also Requires L747) (See Note 1 & 2)
<b>RAP</b>	Additional Alphanumeric Pager for above (See Note 1)
<b>DPU414</b>	Thermal Printer to operate with L747
<b>AD1</b>	Adapter Plate (single gang plate to fit double gang box) (white)
<b>AD3</b>	Adapter Plate horizontal double to Pull switch (white)
<b>LPR</b>	Thermal Printer Paper for obsolete DPU40 Printer
<b>LPR2</b>	Thermal Printer Paper for DPU414 Printer
<b>M1</b>	Door Contact Reed Switch (NO / NC)
<b>NP2</b>	Styled 2 Metre Pear Push Lead
<b>NP4</b>	Styled 4 Metre Pear Push Lead
<b>PM1</b>	Pressure Mat (600 x 300mm) Plugs into call point jack socket
<b>PS1</b>	Plug in Pull Cord for Call Points
<b>RB1</b>	Relay Board
<b>SCP</b>	Slave Call Point (No electronics requires connection to call point)
<b>SRP</b>	Slave Reset/Presence Point (For use with L732 Call Point)
<b>S2</b>	Soft Touch Air Switch with 3m of air pipe.
<b>PIR1</b>	Passive Infra Red Detector (See Note 2)
<b>FJB2</b>	Fused Junction Board
<b>BB1</b>	Surface Mounting Backbox for Intercall styled units

**NOTES:** 1 – SPECIAL PROGRAMMING REQUIRED – PLEASE CONTACT THE SALES OFFICE FOR MORE INFORMATION, 2 – SPECIAL ORDER **NON STOCK ITEM** – PLEASE CONTACT THE SALES OFFICE FOR AVAILABILITY, 3 – REQUIRES INTERCALL BB1 BACKBOX FOR SURFACE MOUNTING – FLUSH MOUNTS INTO STANDARD DOUBLE GANG BACKBOX. ©1999 Lismore Instruments Limited



## Obsolete Order Codes with Replacements

<u>OBSOLETE ORDER CODE / PRODUCT</u>	<u>AVAILABLE EQUIVALENT</u>
<b>L607</b> 600 Series Printer Interface	<b>L747</b> 600/700 Series Universal Interface
<b>L707</b> 700 Series Printer Interface	<b>L747</b> 600/700 Series Universal Interface
<b>L627</b> 600 Series Pager Interface	<b>L747</b> 600/700 Series Universal Interface
<b>L727</b> 700 Series Pager Interface	<b>L747</b> 600/700 Series Universal Interface
<b>L616</b> 600 Series Overdoor Light	<b>L746</b> 600/700 Series Overdoor Light
<b>L626</b> 600 Series Group Overdoor Light	<b>L746</b> 600/700 Series Overdoor Light
<b>L716</b> 600/700 Series Overdoor Light	<b>L746</b> 600/700 Series Overdoor Light
<b>L726</b> 600/700 Series Group Overdoor Light	<b>L746</b> 600/700 Series Overdoor Light
<b>L726S</b> 600/700 Series Overdoor Light + Sounder	<b>L746S</b> 600/700 Series Overdoor Light + sounder
<b>L618</b> 600 Series LCD Display Unit	<b>L628</b> 600 Series Display Unit ( <i>BB1 Backbox required when upgrading surface mounted L618 unit</i> )
<b>PCPC1</b> 600 Series Programming Software & Lead	<b>LIMKIT</b> 600 / 700 Series System Configuration Kit including software.
<b>L722DK</b> 600/700 Door Monitoring Point	<b>L733</b> 600/700 Door Monitor & Access Control Point
<b>AN133</b> 600/700 Non Latching Module	<b>L634</b> Network Input/Output Module
<b>L622_AN134</b> 600/700 Remote Reset Call Point	<b>L634</b> Network Input/Output Module
<b>L622_AN121</b> Call Point with Emergency Input	<b>L622_AN310</b> Call Point with extended inputs and outputs

### AN Order Codes

Some items are available to suit particular applications and call points are available with alternative software to perform specialist functions. The most common AN order codes are described below

<b>L622 AN310</b>	L622 Call point with additional terminals for emergency call from the X2 trigger input
<b>L752 AN121</b>	L752 Call point modified to generate emergency call from the X trigger input



### Getting In touch with Intercall Nursecall Systems

UK Technical Support Telephone 0870 870 4660

Export Department Telephone +44 1403 713240

Fax +44 (0)1403 713141

Or visit: [www.intercall.co.uk](http://www.intercall.co.uk)

This manual is updated regularly and copies may be downloaded in Adobe® Acrobat® format from the website shown above.

# Intercall 600 User Guide.

Layout of the Intercall 622 and 722 Non Audio Call Point.

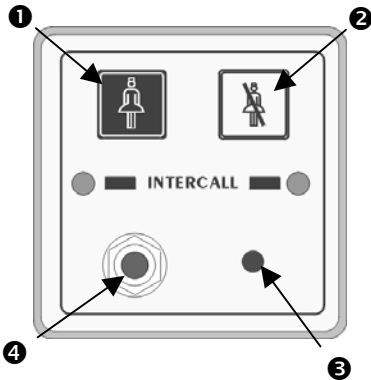

- ❶ Call button.
- ❷ Reset button.
- ❸ Re-assurance light.
- ❹ Jack socket.

Intercall 600 Call levels and what they mean.

**Call** – Standard patient call  
**Assistance** – Staff requiring assistance.  
**Emergency** – Staff requiring urgent assistance.  
**Present** – A member of staff is in the room.  
**Visit** – A member of staff has accepted the call at the display and is on their way to the resident.



### Making a standard call.

A standard call can be generated by any of the following:

- Pressing the **Call button** on the call point.
- Activation of the pear lead (or other device) plugged into the **Jack socket**.
- Operation of a ceiling pull switch wired to the call point.
- Un-plugging the pear lead from the **Jack socket**.

To confirm a standard call is active, the **Re-assurance light** will flash red one per second.



### Staff Present Mode\*.

When members of staff enter a room, they must press the **Reset button** on the call point. The call point is now in ‘Staff Present’ mode and the **Re-assurance light** will show a constant green. Other members of staff can now locate them, by pressing the ‘Show Staff’ button on any display unit. When they leave the room, they should press the **Reset button** again, this tells the system they are no longer in the room & the **Re-assurance light** is off.



### Staff Assistance Call\*.

Staff assistance call can only be generated when the call point is in staff present mode and the **Re-assurance light** showing constant green. Pressing the **Call button** will generate an assistance call and the **Re-assurance light** will alternate red, then green, once a second to confirm this action. To cancel the assistance call, press the **Reset Button** once. The call point is now in staff present mode with the **Re-assurance light** showing constant green. To cancel the staff present, press the **Reset Button** again until the **Re-assurance light** is off.



### Staff Emergency/Crash Call.

Staff emergency call can be generated at any time by pressing the **Call Button** and the **Reset Button** simultaneously (or pressing the **Emergency Button**). To confirm this action the **Re-assurance light** will showing a rapid red flashing light. To cancel the emergency call, press the **Reset Button** once, the call point is now in staff present mode with the **Re-assurance light** showing constant green. To cancel the staff present mode, press the **Reset Button** again until the **Re-assurance light** is off.



### Call Accepted.

To avoid several members of staff from responding to a single call, calls may be accepted from any display unit. To accept a call, wait until the call you wish to accept is on the top line of the display and press the **Accept Button**. The call point **re-assurance light** will flash green to let the resident know that staff are on their way. The call point will return to the calling condition if the call point is not reset within a pre-set time period. Only standard calls and assistance calls can be accepted.

\* Features highlighted in this way, may be disabled by the commissioning engineer.

## Using Intercall 600 Display Units.

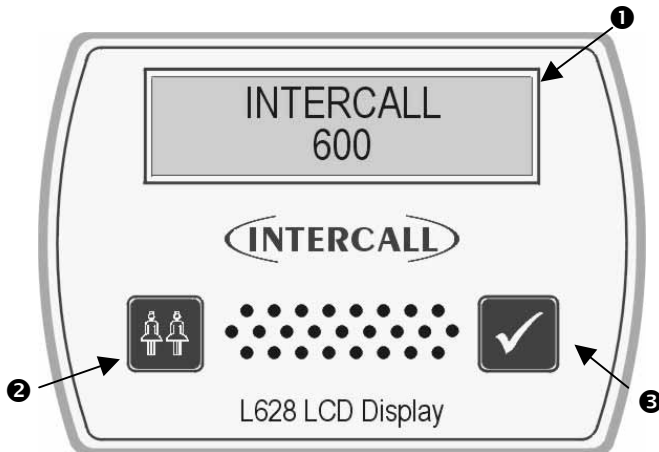

Intercall 600 Call levels and what they mean.

**Call** – Standard patient call

**Assistance** – Staff requiring assistance.

**Emergency** – Staff requiring urgent assistance.

**Present** – A member of staff is in the room.

**Visit** – A member of staff has accepted the call at the display and is on their way to the resident.

❶ Two line LCD display. ❷ Show staff button. ❸ Accept call button.

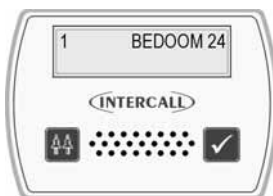

### Standard Call.

A standard call will make a short uninterrupted tone, which repeats every 2 seconds. The number shown on the left identifies the queue position, where the lowest number is the oldest call. The right hand side of the display shows the call location. In the example to the left, there is a call from “BEDROOM 24”.



### More than one Call.

When more than one call is active, the calls are scrolled on the display with their respective queue position. On the example shown to the left, we have two active calls “BEDROOM 24” is the oldest call and is in queue position 1. The call from “DINING ROOM” is more recent and is given queue position 2.

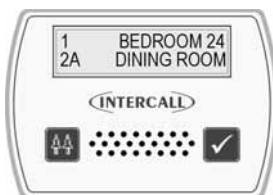

### Assistance Call\*.

An assistance call will make two short tones which are repeated every two seconds. On the illustration to the left, there is a standard call from Bedroom 14 and an assistance call from the Dining Room. The ‘A’ after the call number identifies the call as an assistance call.

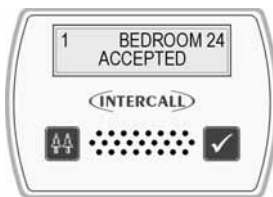

### Accepting a calling resident. (Accept Call/Visit)

To prevent several members of staff from responding to the same call, calls are ‘accepted’ at the display units. To accept a call, simply wait until the call you wish to accept is shown on the top line of the display, then press the **Accept Call** button. It is only possible to accept Standard and Assistance calls shown above.



### Emergency Call.

An emergency call will make a fast series short tones which are repeated continuously. On the illustration to the left, the word ‘EMERGENCY’ indicates the urgency of the call. The accept facility is not available on emergency calls and the staff must attend the room to reset. When an ‘emergency’ call is active, all other calls are held in memory but only displayed when the emergency call is reset.

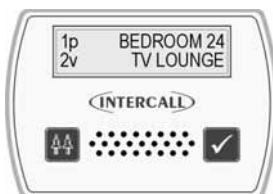

### Locating other members of staff.

To locate other members of staff either in residents rooms or on their way to respond to calls, simply press and hold the **Show Staff** button on any display panel. On the illustration to the left, a member of staff is present in Bedroom 14, indicated by the small ‘P’ and a member of staff has accepted and is visiting the call from the Lounge, indicated by the small ‘V’. Numbering of ‘Visit’ and ‘Nurse Present’ events is the same as standard and assistance calls.

## Intercall 700 User Guide.

Layout of the Intercall 752 Audio Call Point.

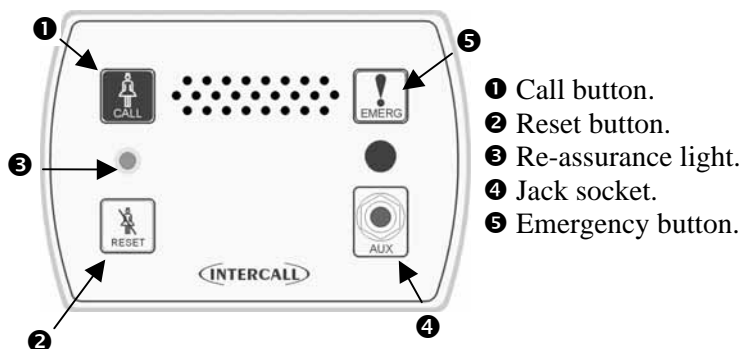

Intercall 700 Call levels and what they mean.

**Call** – Standard patient call

**Priority** – Standard patient call which has remained unanswered for a period of time.

**Assistance** – Staff requiring assistance.

**Emergency** – Staff requiring urgent assistance.

**Attack** – Staff under threat & require urgent assistance.

**Present** – A member of staff is in the room.

**Visit** – A member of staff has accepted the call at the display and is on their way to the resident. If the intercom facility has been used, this will be logged on the printer.

### **Making a standard call.**

A standard call can be generated by any of the following:

- Pressing the **Call button** on the call point.
- Operation of the pear push lead (or other device) plugged into the **Jack socket**.
- Operation of a ceiling pull switch wired to the call point.
- Un-plugging the pear lead from the **Jack socket**.
- Operation of a radio or infra red pendant.

To confirm a standard call is active, the **Re-assurance light** will slowly flash red.



### **Priority Call\***

A Standard call, which has remained active for a pre-set time period will automatically convert to **Priority Call** and the **Re-assurance light** will flash rapidly.

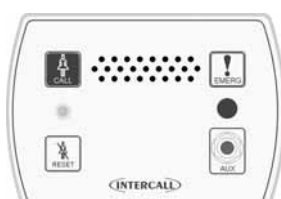

### **Staff Present Mode\*.**

When members of staff enter a room, they must press the **Reset button** on the call point. The call point is now in 'Staff Present' mode and the **Re-assurance light** will show a constant green. Other members of staff can now locate and communicate to this room. When they leave the room, they should press the **Reset button** again, this tells the system they are no longer in the room & the **Re-assurance light** is off.



### **Staff Assistance Call\*.**

Staff assistance call can only be generated when the call point is in staff present mode and the **Re-assurance light** showing constant green. Pressing the **Call button** will generate an assistance call and the **Re-assurance light** will show red, then green once a second to confirm this action. To cancel the assistance call, press the **Reset Button** once. The call point is now in staff present mode with the **Re-assurance light** showing constant green. To cancel the staff present, press the **Reset Button** again until the **Re-assurance light** is off.



### **Staff Emergency/Crash Call.**

Staff emergency call can be generated at any time by pressing the **Call Button** and the **Reset Button** simultaneously (or pressing the **Emergency Button**). To confirm this action the **Re-assurance light** will showing a rapid red flashing light. To cancel the emergency call, press the **Reset Button** once, the call point is now in staff present mode with the **Re-assurance light** showing constant green. To cancel the staff present mode, press the **Reset Button** again until the **Re-assurance light** is off.

### **Staff Attack Calls.**

Staff attack calls can only be generated from an infra red trigger remote from the call point. Attack level calls are indicated by a very rapid red flash on the **Re-assurance light** and can only be reset with a 'reset' infra red trigger, or by a **Guardian** display when used with a combined **Intercall 700 / Guardian** system.

### **Paging other members of staff\*.**

Locating and communicating with other members of staff is simplicity with the Intercall 700 system. Simply press and hold the **Reset button** and you can page to all other Displays and Call points in **Staff Present** mode.

## Layout of the Intercall 758 Audio Display Unit.

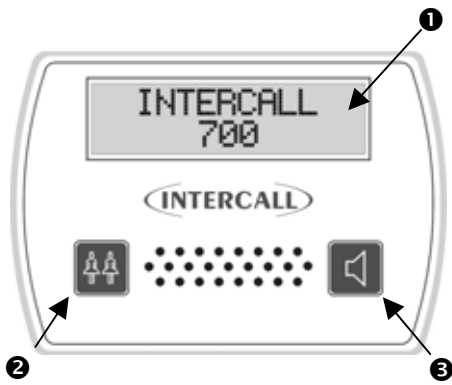

① Two line LCD display. ② Show staff button. ③ Accept call / Intercom button.

### Intercall 700 Call levels and what they mean.

- Call** – Standard patient call
- Priority** – Standard patient call which has remained unanswered for a period of time.
- Assistance** – Staff requiring assistance.
- Emergency** – Staff requiring urgent assistance.
- Attack** – Staff under threat & require urgent assistance.
- Present** – A member of staff is in the room.
- Visit** – A member of staff has accepted the call at the display and is on their way to the resident.

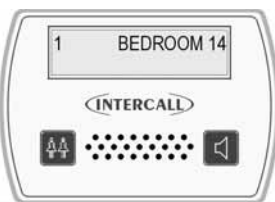

### Standard Call.

A standard call will make a short uninterrupted tone, which repeats every 2 seconds. The number shown on the left identifies the queue position, where the lowest number is the oldest call. The right hand side of the display shows the call location. In the example, there is a call from “BEDROOM 24”.



### More than one Call.

When more than one call is active, the calls are scrolled on the display with their respective queue position. On the example shown to the left, we have two active calls “BEDROOM 24” is the oldest call and is in queue position 1. The call from “DINING ROOM” is more recent and is given queue position 2

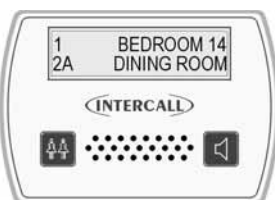

### Assistance Call\*.

An assistance call will make two short tones which are repeated every 2 seconds. On the illustration to the left, there is a standard call from Bedroom 14 and an assistance call from the Dining Room.

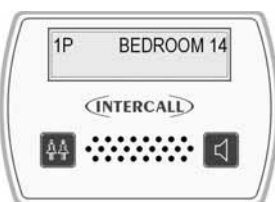

### Priority Call\*.

If a standard call remains un-answered, it automatically converts to a Priority Call. A Priority call is indicated with a letter ‘P’ after the call number. The intercom facility is not available on priority calls and the staff must attend the room to reset. When a priority call is active, all standard and assistance calls are held in memory but only displayed when the priority is reset.



### Emergency Call.

An emergency call will make a fast series short tones, which are repeated continuously. On the illustration to the left, the word ‘EMERGENCY’ indicates the urgency of the call. The intercom facility is not available on emergency calls and the staff must attend the room to reset. When an ‘attack’ or ‘emergency’ call is active, all other calls are held in memory but only displayed when the emergency call is reset.

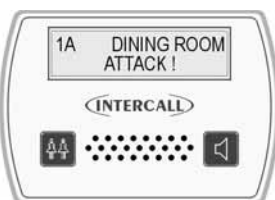

### Attack Call.

An attack call will make a fast series short tones, which are repeated continuously. On the lower line of the LCD, the word ‘ATTACK’ is displayed similar to an emergency call. The intercom facility is not available on emergency calls and the call can only be reset with an infra red ‘reset’ trigger or using a Guardian display unit. When an ATTACK or EMERGENCY call is active, all other calls are held in memory but only displayed when the emergency call is reset.

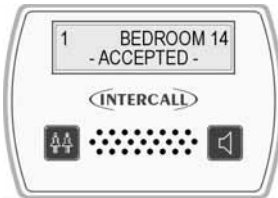

### Accepting a call. (Accepting a non-speech call)

To prevent several members of staff from responding to the same call, calls are 'accepted' at the display units. To accept a call, simply wait until the call you wish to accept is shown on the top line of the display, and press the **Accept Call** button. It is only possible to accept Standard and Assistance calls shown previously. If you are accepting a non-speech call point (such as a toilet or door point) then the call will be removed from the display and the sounder silenced for a pre-set period of time.



### Accepting a call and speaking to a calling resident.

To accept and speak to a resident, the procedure is the same as 'accepting a call' above. Wait until the call you call you wish to speak to is shown on the top line of the display, press & release the **Accept Call** button. Once the word "speech open" appears, you will be able to hear the caller. Press and hold the **Accept Call** button when talking to the resident. Once the conversation is complete, press the **Show Staff** button once to close the intercom. *(The speech channel will close after 60 seconds automatically)*

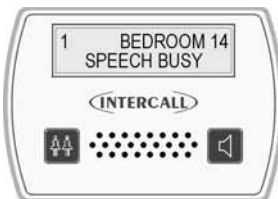

### Speech Busy.

To indicate to all other users that the speech channel is in use, 'Speech Busy' appears on the lower line of all other displays on the system and this is shown to the left. On all other displays, new calls will be shown using the top line of the LCD only and calls may be accepted (as non-speech calls) but the intercom facility will not activate.

### Locating other members of staff.

To locate other members of staff, press and hold the **Show Staff** button on any display panel. On the left, a member of staff is present in Bedroom 14, indicated by the small 'p' and a member of staff is dealing with the call from the Lounge, indicated by the small 'v'.

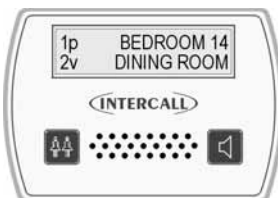

### Paging all other members of staff.

To page all staff, simply press and hold the **Talk** button and speak to all other displays and call points in **staff present** mode. This is only possible when no calls are active on the system and is not possible when 'Speech Busy' is displayed on the lower line of the LCD.

## User ID on the Intercall 700 System.

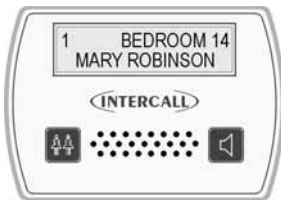

### How the displays show who is calling\*.

With the Intercall 700 system, it is possible to display the residents name, as well as their location when calling. We call this feature **'User ID'**. In order to register their name on the system, the resident must trigger the call point with an infra red trigger assigned to their name. All Intercall 700 Call Points are fitted with an infra red receiver which picks up these signals.

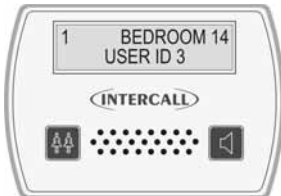

### Standard Calls/Assistance Calls/Priority Calls.

The main difference when the **User ID** is enabled, is that both lines of the LCD are used for each call. On the top line, the location is displayed as previously and on the lower line, the **User ID** is displayed. Above left, is a standard call from 'Bedroom 14' activated by the trigger allocated to 'Mary Robinson'. To the left shows the factory default 'User No' rather than the residents name.



### Secondary Descriptions\*.

Four **User ID**'s are reserved as **System User ID**, these allow common descriptions to be allocated to other calling devices, connected to the call point. For example, a ceiling pull switch in an en-suit bathroom may be given the secondary description "EN-SUIT BATH". This will be combined with the room description when the switch is activated to produce "BEROOM 14 EN-SUIT BATH" as shown on the left.



### More than one call active.

When more than one call is active, the calls are scrolled on the LCD display as normal but you can only see one call at any time. Each call is shown with the corresponding **Caller ID**. On the right we have a second call activated, with call number '2' and this time from 'Peter Jenkins' in the 'Dining Room'.



### No User ID.

If a call point is not triggered from the infra red trigger, it is not possible to establish which resident activated the call point. When this occurs, the lower line of the display reports **'No User ID'** as shown on the left. **This feature can be disabled at the commissioning stage.**

## Using the L768 Room Communicator.

The L768 Room Communicator allows the intercom speech path to be initiated to a Call Point without the Call Point having called first. The unit is very simple to use with the desired room selected using the rotary control on the front panel. General announcements (such as lunch times etc) can also be made from the unit and these are sent into all bedrooms. The L768 must be used in conjunction with L758 displays to show and sound for calls from the rooms.

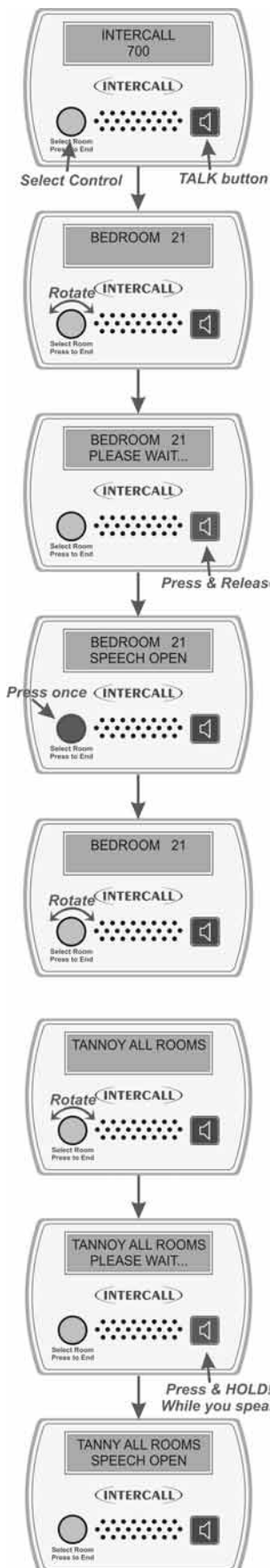

### To call and speak to a room.

Turning the SELECT control (Shown on the left) clockwise or anticlockwise will scroll through all available call points on the system. You may contact any call point which is not currently calling. Rooms can be contacted regardless of other system activity, providing the speech channel is not in use. While the rooms are being contacted, the call point buttons are inactive.

### Selecting the desired room.

Turn the Select control until the desired room is showing on the top line of the display. In the example shown on the left BEDROOM 21 is being selected.

### The privacy bleep.

With the desired room showing on the top line, press and release the TALK button as shown on the left. There will be a small delay while the room is contacted before the privacy bleep is sounded at the call point and at the Room Communicator. While the room is contacted, the screen will show PLEASE WAIT on the lower line of the display.

### Opening the speech channel.

After the privacy bleep has sounded, the intercom channel will be open and the call point will be able to speak to the Room Communicator. Press and hold the TALK button while speaking to the room and release to allow the room to speak. While the speech channel is open the words "Speech Open" will be showing on the lower line of the display.

### Closing the speech channel.

When the conversation is complete, the intercom may be closed by pressing the SELECT button once. This will reset the unit and close the intercom channel.

### Selecting another room.

Once the speech channel has been closed and the room is again showing on the top line of the display, another room can be selected using the SELECT control as previously described. Alternatively, if the SELECT control is not operated for 10 seconds, the unit will return to the default text (Intercall 700)

### Broadcast or Tannoy messages to all rooms.

The room Communicator can also be used to send common messages to all Call Points. Call Points can be contacted regardless of other system activity, providing the speech channel is not in use.

### Selecting tannoy.

Turning the SELECT control (Shown on the left) clockwise or anticlockwise will scroll through the rooms on the system. Use this method until TANNOY ALL ROOMS is shown on the LCD display.

### Using the Tannoy.

With TANNOY ALL ROOMS showing on the display, press and **HOLD DOWN** the TALK button. There will be a small delay while the rooms are contacted before the privacy bleep is sounded in the room and at the Room Communicator. While the room is being contacted, the screen will show PLEASE WAIT on the lower line of the display. Now make the announcement and release the TALK button. It is not possible for the rooms to speak back to the Room Controller in this mode. While the rooms are being contacted, the call point buttons are inactive.





### Call/Display Unit.

The L762 Call/Display Unit combines the features of the L752 Call Point and L758 LCD Display unit. Calls are generated in the same way as with the Audio Call Point discussed previously, with the exception that there is no separate emergency button. (*Emergency calls are generated by pressing both call and reset buttons simultaneously*) The LCD display is enabled when the call point is in 'Staff Present Mode' and operates in a similar way to the LCD Display Unit also described previously.



Normally, when no call is active on the system, the LCD will show the programmed default text and the factory default is 'Intercall 700'. If an Emergency or Attack call is active, the LCD display will show this call, but the sounder will not operate unless the call point is in 'Staff Present' mode.



### How the displays show faults on the system.

The system is continuously monitored and should a system fault occur, the lower line of the LCD will read System Fault and this is accompanied by an audible alarm, which informs of problems without becoming intrusive.

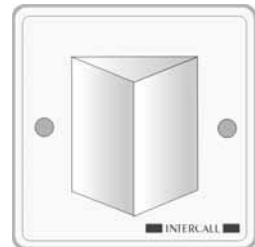

### Overdoor Lights.

Overdoor lights are an optional item generally located outside the room to relay the status of the call point within the room. The unit is fitted with twin red/green LED's which mimic the re-assurance LED on the call points.

### Overdoor Light Call Patterns.

**Call** – Slow Flashing Red

**Priority** – Fast Flashing Red

**Assistance** – Alternating Red / Green flash

**Emergency** – Rapid Red Flashing.

**Attack** – Very Rapid Red Flashing.

**Present** – Continuous Green Indication.

**Call Accepted / Spoken** – Slow Green Flashing

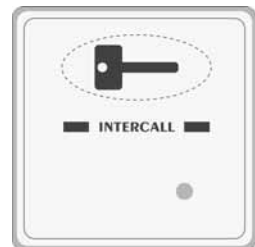

### Door Monitoring and Access Control Points.

Generally used to monitor fire doors and main entrances for unauthorised entry or exit. Token allows door to be opened by authorised personnel without sounding the alarm and isolated to allow the door to be left open if required. *See page 33*



### Slave Call Points.

Similar to standard call points, these units are generally used in rooms with several beds. The unit can only generate a standard call from the CALL button or jack socket. There is no facility to reset and this must be done on the standard call point within the room.

### Slave Reset/Present Points.

Similar to standard call points, these units are located by the door of the room or ward to allow the staff to generate staff present indication and to reset the call away from the call point. There is no call facility on this unit. *See page 54*

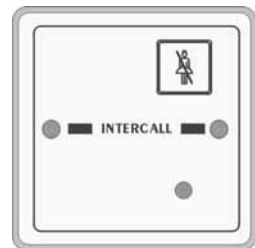

### Remote Infra Red Trigger.

The TIR4 Infra Red Trigger may be used to make a call away from the call point without trailing wires. All Intercall 700 call points are fitted with an infra red receiver as standard, which will receive signals from the trigger within a typical 5 x 5 metre room. *See page 51*

### Pear Leads.

Pear leads are used to trigger the any Intercall call point. They are available in 2metre and 4metre lengths terminated with a 90 degree jack plug. There is a clip which may be used to secure the lead to bedding or residents clothing. The unit features a wipe clean, soft touch switch which is easy activated with light finger pressure.

## Installation Guide.

### System Concepts.

Both the Intercall 600 and Intercall 700 systems are fully addressable and network devices only require a connection to the common “Network” to operate. The Intercall 600 system uses a two core network for power and signals, while the Intercall 700 audio system uses a four core network, one pair for power and signal and the other pair for audio. All units are fitted with a positive (+) and negative (-) terminal and Intercall 700 audio devices have additional (a) and (b) terminals for the audio pair.

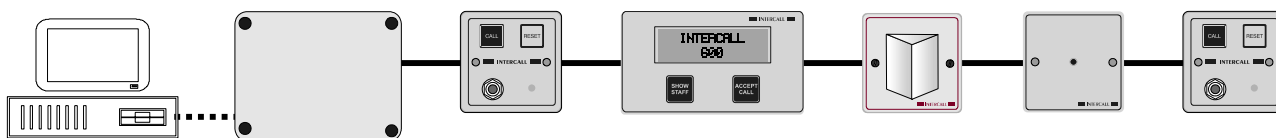

*‘Network Devices’ (Call Points, LCD Displays, Overdoor Lights etc) connect to the ‘Network’ which provides all power.  
The system may be configured using a PC or Laptop Computer which connects to the L717 Power Supply.*

As can be seen on page 3, several Intercall 600 and Intercall 700 network devices may be used on either systems. In addition, it is not necessary to have the audio feature on an entire Intercall 700 system, for example L722 Non Audio Call Points may be used within the bedrooms while Audio Call Points and Audio Displays are used elsewhere on the system. To reduce audio interference and costs, we recommend that the network audio pair is only run to the parts of the system where the audio feature is required.

As with all systems of this nature, the integrity of the network cabling is paramount to the performance and reliability of the system. Excessive cable volt drop must be avoided and to achieve this we recommend the use of a heavier “Spine” cable between Power Suppl(ies) and to Junction Units, then lighter “Spur” cables from the Junction units, taking in the network devices. The network output from the power supply runs at 13.8V and the network devices will operate down to 10 Volts permitting a 3.8v maximum volt drop along the network cables to the furthest device.

We only recommend the use of FJB units, which have fused outputs for the wiring of individual sections of the system. Generally, one FJB would be located on each floor on wing of the establishment, with the Spine Cable connecting them back to the Power Supply Units.

### Understanding “Current Units”.

The amount of volt drop experienced in each length of cable depends on the size of the cable and the total amount of current drawn by the network devices attached to it. To simplify the cable run calculations, we have given each network device a ‘Current Unit’ value, which reflects the amount of current drawn by that unit. The following limits apply: **1. The absolute maximum length of each spur from the FJB 2. The maximum number of ‘Current Units’ per spur from the FJB. 3. The spine cable is also limited to a maximum length per system.**

### Network Cable for Intercall 600 and Intercall 700 Non speech Installations.

Use a 2 core non screened minimum  $0.75\text{mm}^2$  (24/0.2) cable for the network ‘Spine’ between the power supplies and to the FJB’s and 4 or 6 core non-screened stranded security alarm cable  $0.22\text{mm}^2$  (7/0.2) for the network spur outputs from the FJB.

### Network Cables for Intercall 700 speech Installations.

We recommend 2 core non screened minimum  $0.75\text{mm}^2$  (24/0.2) and **Belden 8760** for the network spine and **Belden 8723** for the network spur outputs from the FJB.

**Belden 8760** is a single pair cable, connect to the (A) and (B) terminals with the screen drain wire connected to (-) and use 2 core the  $0.75\text{mm}^2$  non screened for the (+) and (-) connections.

**Belden 8723** is a two pair individual screened cable. Use one pair for the (+) & (-) & one pair for the (A) & (B). Connect the screen drain wire to the Network (-) terminal.

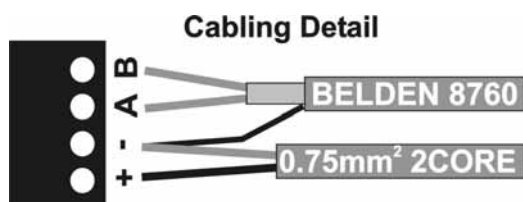

Belden cable (or equivalent) is available from  
Commtech Communications [www.commtechcomm.com](http://www.commtechcomm.com)  
Phone +44(0)1254 232638 Fax +44(0)1254 301197  
or other specialist suppliers.

## Planning an Installation.

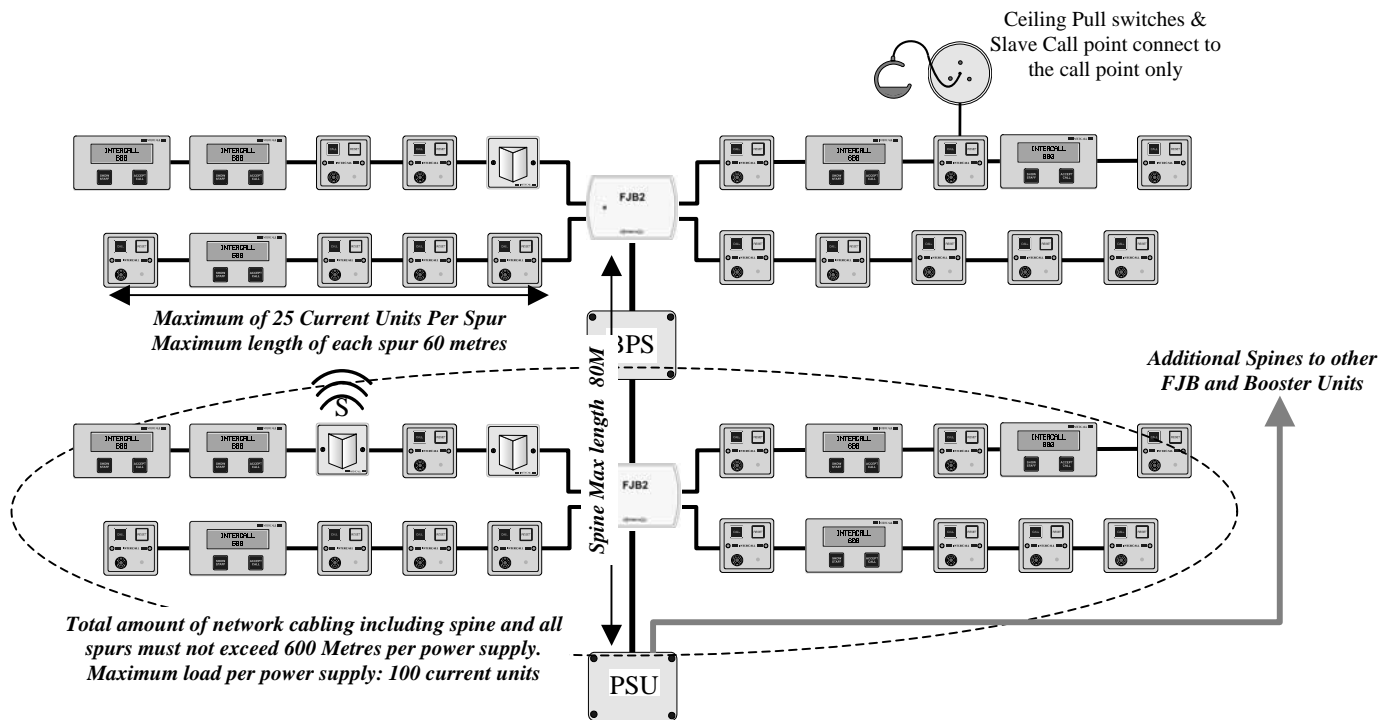

- Locate the **L717 PSU/Controller** in a central location of the building and run “**Spine**” cable(s) to FJB and Booster Power supply locations. We recommend one FJB/Booster location per floor & the spine cable running between floors.
- Run a maximum of 4 cable spurs from the FJB’s each no longer than 60 metres with a **maximum of 25 current units per spur**. See the chart on the right for a “**Current Unit**” rating for each network device.
- If the system requires more than **100 current units** – split the system with a **Booster Power Supply**.
- If the system requires more than 600 metres of network cable (including the spine and all spurs) – split the system with a **Booster Power Supply**.
- Each spine cable must be no longer than 80 metres from **Master Power Supply** to furthest **Booster Power Supply** (or FJB)
- All **Booster Power Supply** inputs must be connected to the **Master Power Supply** output. *See page 33*
- Avoid running Network cables alongside mains cables., fluorescent lights, electrical switch-gear, lift machinery and motors and high voltage cables.
- Never use two cores within a four core cable where the other cores are used by another Intercall system or other system such as Fire Alarm, Telephone etc.
- **There must be NO CONNECTION between the Network + or – and mains electrical earth always check with a suitable meter before switching on the system.**
- **IMPORTANT** The spur length limits assumes that units are located at regular intervals along the length of the cable and that a maximum of 20% of the call points are calling at any one time. This limit can be increased by reducing the length of spur or number of current units attached to the spur. *Eg 40% of the units calling at any one time, max cable run 30 metres or maximum 12 current units per spur.*

The following table shows the number of ‘**Current Units**’ for each piece of equipment

Device	Description	No of Units
L622	Standard Call Point	1
L622M	Magnetic Call Point	1
L733	Door Monitoring Point	1
L634	I/O Module	1
CS1	Ceiling Pull Switch	0
SCP	Slave Call Point	0
L628	Larger LCD Display	4
L746	Overdoor Light	1
L746S	Light + Sounder	3
L714	Remote Sounder	4
L747	System Interface	4
RB1	Relay Board	2
PIR1	Passive Infra Red Unit	1
L722	Infra Red Call Point	1.5
L752	Audio Call Point	2.5
L758	Audio Displays Unit	4
L762	Audio Call/Disp Unit	2.5

## Replacing an existing System – using the existing wiring.

The **INTERCALL** system is ideally suited for the replacement of existing hard wired nursecall system, using the existing cabling but please note the following considerations.

- Study and make notes about the existing system.

The most common problems occur when the old system is removed before the wiring is understood. We need to identify two cores common to all parts of the system which are usually the supply lines. Look for legends on the printed circuit boards (**0v**, **GND**, **+12** + etc)

- Remove all parts of the old system from the wiring.

Another common problem is where parts of the old system are still connected, a remote sounder, bell or buzzer in another part of the system.

- Make sure the old power supply is switched off and disconnected from the system.

Do not attempt to keep the old system running on the same cables as you are installing the new system, you are most likely to damage both systems and delay completion.

- Beware of Multi-core cables.

Multi-core cable is often used on older systems where every call point requires an individual connection back to the display panel. This cable must be 80 pair cable (160 cores) is quite common. If you are using multicore cable you should only use two cores within the multi-core length. If this cable is too small to connect the amount of current units required, then this cable should be replaced with a cable of the SPINE specification.

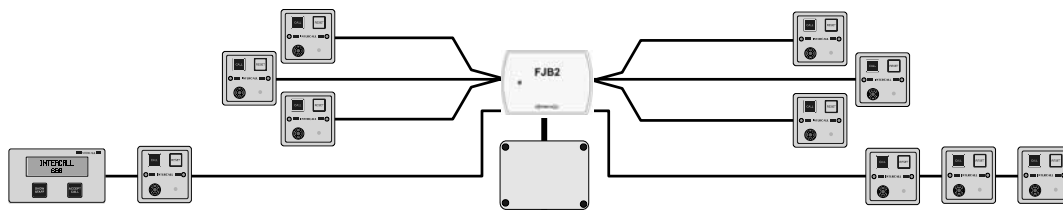

When using the existing cabling, normally there is one cable back from each call point. In this instance, we would connect several call points cables together (*to a maximum of 25 current units*) and connect them to one single output of the FJB. Once the existing cabling is connected, additional spurs can be run from the FJB for new extensions as shown above.

## Typical New Installation.

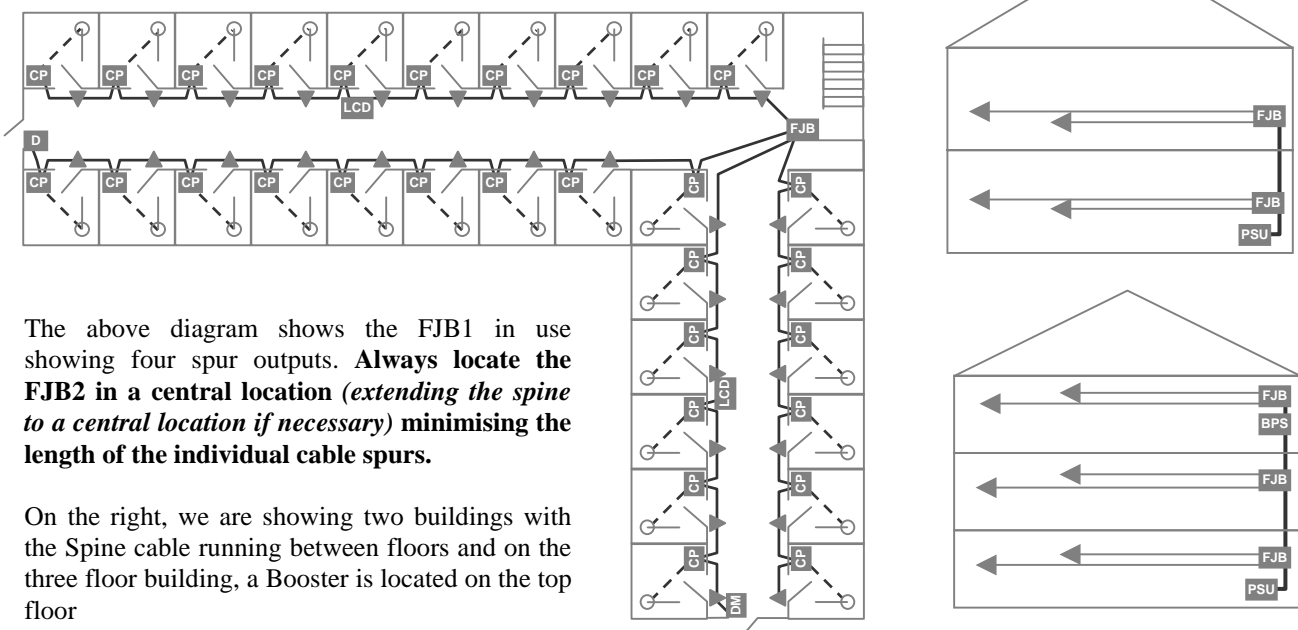

The above diagram shows the FJB1 in use showing four spur outputs. **Always locate the FJB2 in a central location (extending the spine to a central location if necessary) minimising the length of the individual cable spurs.**

On the right, we are showing two buildings with the Spine cable running between floors and on the three floor building, a Booster is located on the top floor

**FJB's in use.**

This page shows the typical installation of a L717/L7717 Master Power Supply and a single FJB2 Fused Junction Box. This application circuit may be repeated, where the 'PSU' is a Booster Power Supply, providing the input for all Booster Power Supplies are connected to the master output. *See page 33*

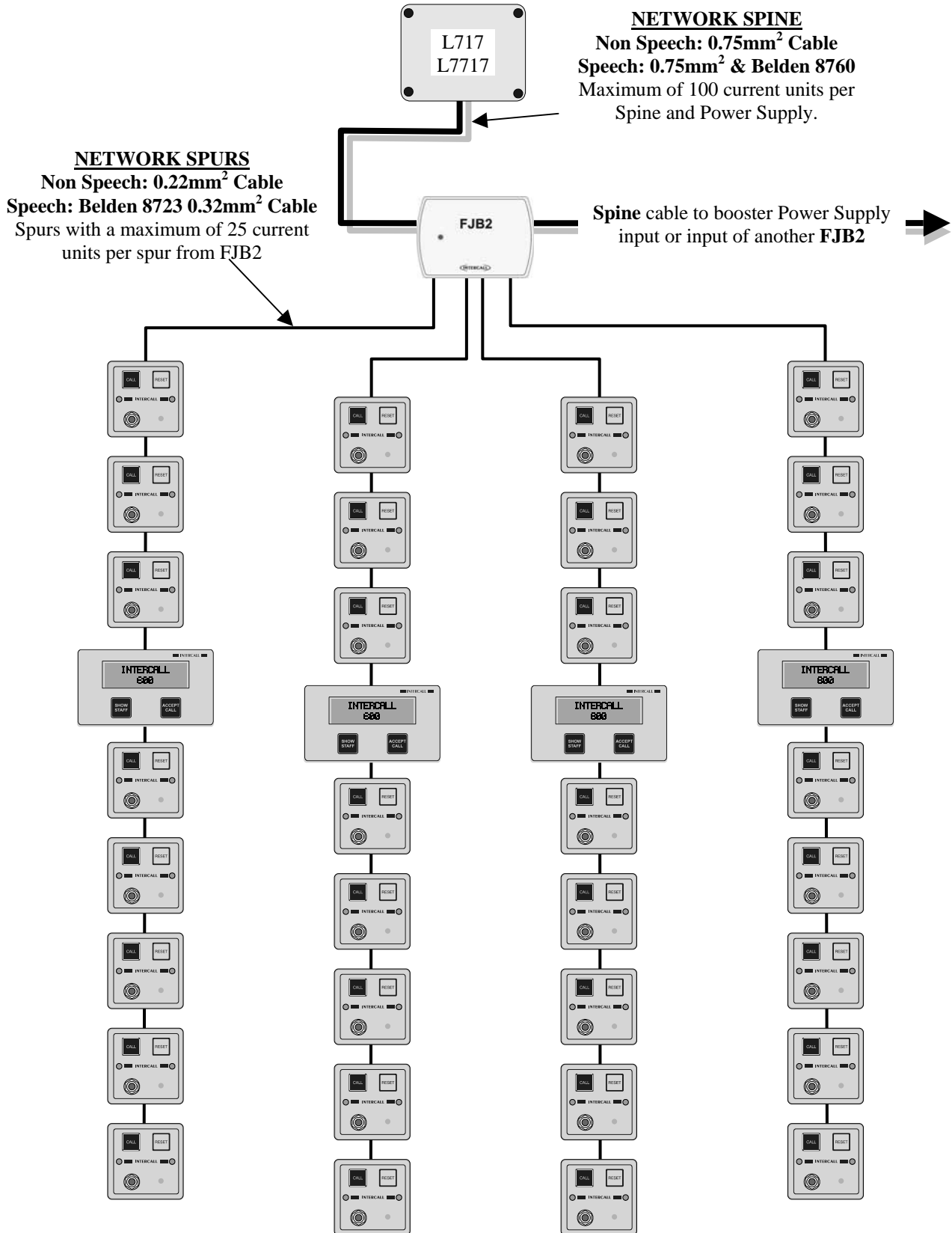

## First Fix.

Please read the advice given on page 17 with regard to power supply position and required cabling techniques.

<b>INTERCALL 600 and 700 Mains connection requirements</b>	
<b>L617</b> 600 Series Master Power Supply	Non Switched Fused Spur unit with 5amp fuse fitted
<b>L717</b> 700 Series Master Power Supply	Non Switched Fused Spur unit with 5amp fuse fitted
<b>L737</b> 600/700 Series Booster Power Supply	Non Switched Fused Spur unit with 5amp fuse fitted
<b>L748</b> 600/700 Corridor LED Display	Non Switched Fused Spur unit with 5amp fuse fitted
<b>RFTX</b> Scope pager transmitter	Non Switched Fused Spur unit with 5amp fuse fitted
<b>DPU414</b> Thermal Printer	Standard 13amp socket

Due to the wide variety of fixing possibilities, the Intercall system is not supplied with backboxes. We recommend the following available from your local electrical wholesaler or supplier.

<b>SURFACE MOUNTING:</b> INTERCALL BB1 BACKBOX <b>FLUSH MOUNTING:</b> 35mm Depth DOUBLE METAL BOXES	<b>SURFACE MOUNTING:</b> CRABTREE 9047 or CONTACTUM 1042 <b>FLUSH MOUNTING:</b> 25mm Depth SINGLE METAL BOXES*
<b>L628</b> 600 SERIES DISPLAY UNIT	<b>L622 / L722</b> NON AUDIO CALL POINTS
<b>L752</b> 700 SERIES AUDIO CALL POINT	<b>L746</b> 600/700 SERIES OVERDOOR LIGHTS
<b>L758</b> 700 SERIES AUDIO LCD DISPLAY UNIT	<b>L714</b> 600/700 SERIES REMOTE SOUNDER
<b>L762</b> 700 SERIES AUDIO CALL/DISPLAY UNIT	<b>RX1</b> RADIO RECEIVER
<b>FJB2</b> 600 / 700 SERIES PROTECTED JUNCTION BOARD	<b>RB1</b> RELAY BOARD
<b>L747(MK2)</b> 600 / 700 SERIES UNIVERSAL INTERFACE	<b>PIR1</b> PASSIVE INFRA RED DETECTOR

### VERY IMPORTANT

**DO NOT USE METAL BACKBOXES BOXES WITH FOUR MOUNTING LUGS AS THEY RESTRICT ACCESS AND CAN DAMAGE SOME UNITS.**

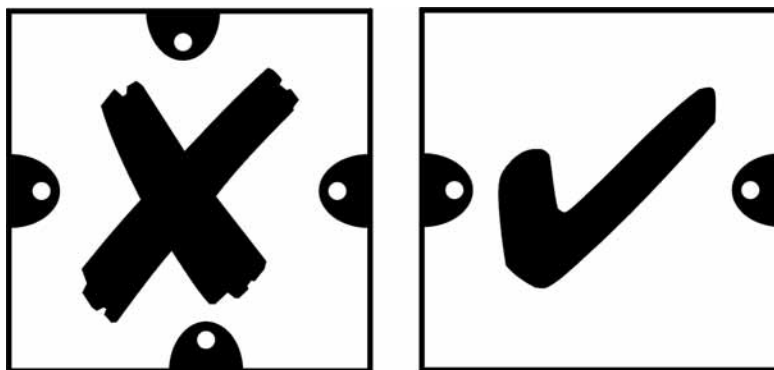

<b>INTERCALL 600 and 700 Equipment which is not mounted in backboxes</b>	
<b>L617</b> 600 Series Master Power Supply	Wall Mounted W240 x H180 x D100 (Allow 200mm access on all sides)
<b>L717</b> 700 Series Master Power Supply	Wall Mounted W240 x H180 x D100 (Allow 200mm access on all sides)
<b>L737</b> 600/700 Series Booster Power Supply	Wall Mounted W240 x H180 x D100 (Allow 200mm access on all sides)
<b>TP1</b> Tone Pager Kit	Desk Mounted – Requires no fixed installation
<b>RFTX</b> Scope Transmitter Kit	Wall Mounted W190 H330 D100 (Not including aerial) (Allow 200mm Access around all sides)
<b>CS1</b> Ceiling Pull Switch	Surface mounting only - Requires no backbox
<b>DPU414</b> Thermal Printer	Desk Mounted – Requires no fixed installation

## First Fix Recommendations.

- Always mount call points above the final bed height to avoid damage to the call points if the beds are moved.
- **IMPORTANT** Ensure Infra Red call points are located in a position suitable for infra red reception and are not obscured by curtains, doors or furniture etc. Infra Red Receiver only units are best located on the ceiling or high on the wall. If the infra red performance is crucial to your system, always perform a site test before installation to establish the optimum location and quantity of infra red receiver units.
- Locating Infra Red Call Points in direct sunlight may degrade their performance.
- **HIGH FREQUENCY FLUORESCENT LIGHT FITTINGS** must operate above 50KHz at all times to ensure they do not interfere with infra red systems. Most lighting manufacturers are aware of this issue and can recommend suitable light fittings.
- Locate LCD displays at typically 1600mm from the ground for ease of use.
- **DO NOT** locate any device directly above a radiator or other heat source as this may affect the front panel label and operation of the unit and LCD display.
- Power Supplies must be located in accessible positions for programming and maintenance access.
- Radio RFTX transmitters must not be located within 10 metres of any Intercall power supply.
- Do not locate audio call points and Audio display units 'back to back' on stud or partition walls as this will cause audio feedback as there is insufficient audio insulation between the two units to prevent this from occurring.
- When first fix is completed ensure INTERCALL parts are stored safely and the back-boxes and any bare wires are protected from paint, nails and plaster!.

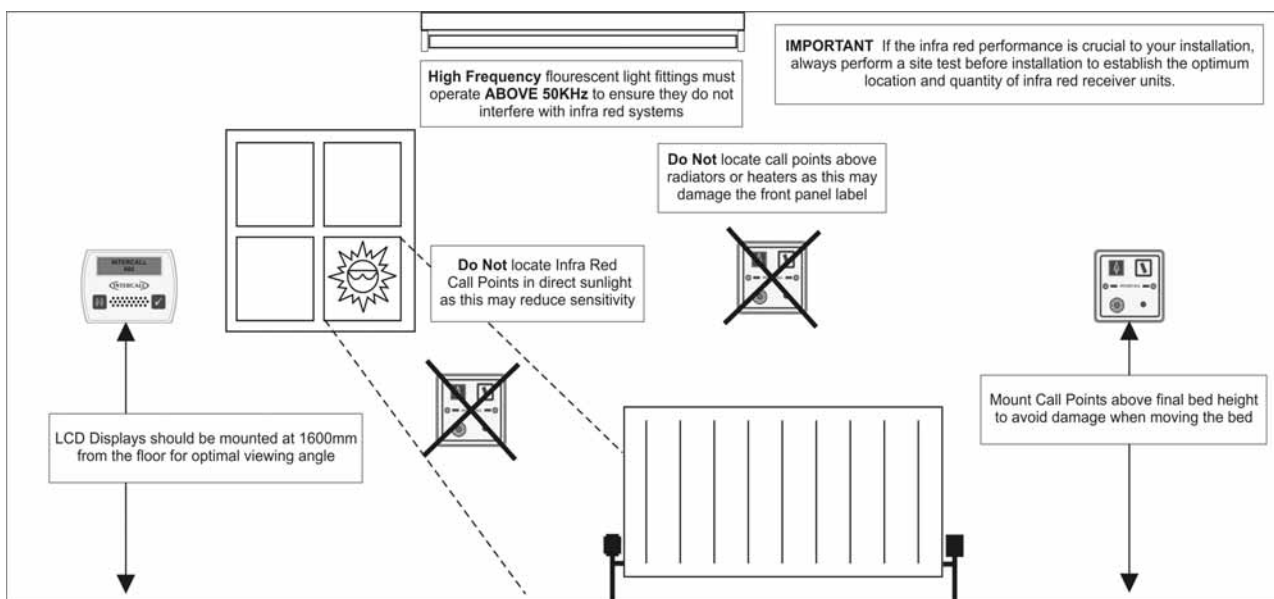

## Second Fix.

These pages cover the connecting and basic testing of all parts of the system. It is intended as a brief overview for connecting and testing for the first time and does not go into great detail on each individual unit. Detailed information on each individual unit is covered from page 29 and the user guide from page 9.

### Connecting the L617/L717 Master Power Supply.

- Connect the mains supply to the L717 Power Supply and switch on.
- The alarm will sound for about 4 seconds while the unit carries out a power on reset.
- If the supply is unstable, due to flat battery, a short on the output wiring or fluctuating mains supply, the unit will not reset and the alarm will continue to sound.
- After the reset, the following light should be visible: The Yellow '**Mains OK**' LED, the Green '**DC OK**' LED and the red '**Micro**' LED will be flashing at once a second.
- If the mains supply of off, the Yellow LED will not light & the mains failure alarm will beep every 5 seconds.
- If the Green LED is not lit check the fuse is intact and the fuse holder is tight around the fuse connections.
- Do not switch the system on by connecting the battery as the surge may blow the fuse.
- Switch off and connect one 'leg' of the installation so that we can test the operation of the units.
- Once the units are connected, test the system as per the instructions in page 24 Basic System Test.

**ALWAYS CHECK THE POLARITY OF THE BATTERY AND ALL UNITS BEFORE SWITCHING ON!**

**All network devices are fitted with reverse polarity protection and the PSU network output fuse will blow or the power supply will shut down if any unit is connected incorrectly.**

### Basic System Test – Power Up.

Before the system is tested, the call point(s) address switches will need to be set. If you are testing a single call point set up we recommend setting the unit to BEDROOM 1. (Switch 1 OFF, All others ON) There is a complete list of factory text settings in this guide. If you will be using overdoor lights, set the switches on the overdoor light to the same setting as the call point.

- Connect the L617/L717 Master Power Supply and test as per the instructions as detailed above and switch the mains supply on.
- When power is applied to the call points, the re-assurance LED will flash green three times to indicate the unit has reset and is running correctly.
- When power is applied to the display units, the display will show the software version (e.g. **V2.01**) followed by the default standing text. The factory default standing text is **INTERCALL 600** or **INTERCALL 700** depending on the system.
- When power is applied to the overdoor lights they illuminate the three green flash start up pattern. Set the address switches in the same way as the Call Point addresses. (See page 37 for more information)

If you are not sure that the above power up sequence has operated correctly, please see page 75 Fault Finding Guide.

### Basic System Test - Call Test. (Intercall 600/700)

Once the system has powered up correctly, the following test can be carried out:

*All items marked \* are optional and may not be fitted on your system.*

- Press the **CALL** area on a call point.
- The red re-assurance LED will flash slowly on the call point.
- After a short pause, the display will sound and the LCD display will be showing **1 BEDROOM 1**.
- \* The overdoor light assigned to BEDROOM 1 will show the standard call signal. (Slow Red Flash)
- Press the **RESET** area on the call point to reset.



### **Basic System Test - Accept Call. (Intercall 600/700)**

The following tests apply to standard Intercall 600 and Non Audio Intercall 700 installations. With the display sounding and showing the call, press the **CALL ACCEPT** button. The following will happen.

- The call point re-assurance LED will stop flashing red and flash green.
- The LCD will briefly display - **ACCEPTED** - on the lower line and the alarm will stop sounding.
- The call will be removed from the display and the LCD display will show **INTERCALL 600/700**.
- \* The overdoor light will show slow flashing green.
- If you press and hold the **SHOW STAFF** button on the display after a pause you will see **1v BEDROOM 1**.
- Release the **SHOW STAFF** button
- After a delay, the call will return as per 1.
- Press the **RESET** area on the call point to reset.

*The Accept Call, Nurse Present functions and the delay period can be disabled or configured for different applications and may not be enabled on your system. Please see page 57 for more information.*

### **Basic System Test - Accept Call & Open Intercom. (Intercall 700 only)**

With the display sounding and showing the call, press the **CALL ACCEPT** button. The following will happen.

- The call point re-assurance LED will stop flashing red and flash green.
- The LCD will briefly display - **ACCEPTED** - on the lower line and the alarm will stop sounding.
- The call will remain on the top line and **SPEECH OPEN** will be displayed on the lower line.
- The intercom channel will open and it is possible to listen to the call point.
- Press and hold the **ACCEPT** button on the display to speak to the call point.
- To cancel the intercom channel, press the **SHOW STAFF** button.
- The call will be removed from the display and the LCD display will show **INTERCALL 700**.
- \* The overdoor light will show slow flashing green.
- If you press and hold the **SHOW STAFF** button on the display after a pause you will see **1v BEDROOM 1**.
- Release the **SHOW STAFF** button
- After a delay, the call will return as per 1.
- Press the **RESET** area on the call point to reset.

### **Basic System Test - Nurse Present & Location. (Intercall 600/700)**

With no call active and the display showing the default text (**INTERCALL 600 or 700**), test the following:

- Press the **RESET** area on the call point and the green LED will light continuously.
- If you press and hold the **SHOW STAFF** button on the display after a pause you will see **1p BEDROOM 1**.
- \* The overdoor light will show continuous green indication.
- Press the **RESET** area on the call point to reset.

### **Basic System Test – Staff Page. (Intercall 700 only)**

With no call active and the display showing the standing text (**INTERCALL 700**) the following tests may be carried out:

- Press and hold the **ACCEPT** button on the display.
- Your speech will be amplified and output from every display on the system.
- Your speech will also be output from all call points in nurse present mode. *See page 11*
- You can also page from the call point as follows:
- Press the **RESET** area on a call point so the green LED lights continuously.
- Press and hold the **RESET/PAGE** button on the call point.
- Your speech will be amplified and output from every display on the system.
- Your speech will also be output from all call points in nurse present mode. *See page 11*
- Press the **RESET** area on the call point so the green LED is extinguished.

*The above are simple system tests, for more detailed information, please refer to page 9 User Guide.*

## System Test Using the L747 'Network Scan' feature.

The L747 has a built in function that scans the entire Intercall 600 and/or Intercall 700 system and gives you a timed and dated printout of all programmed text in the system (Address Text and Caller ID\*), list of addresses with active devices, pre-programmed pager address and the number of network devices (Call Points) on the system.

*\*Intercall 700 only.*

How do I get a printout?

Simple, just connect a DPU414 Thermal Printer in the normal way and set up the L747 for Printer mode. (All DIP Switches in the off position and the jumpers JP1 and JP2 on one pin only) Now, with the L747 LED flashing and the printer on-line switch SW2 to the ON position.

You can leave SW2 in the ON position if desired and switching it back to the OFF position will make the unit print the diagnostic printout again.

Ideal for:

- Finding double addresses
- Finding faulty cabling/call points
- Making sure all call points have the correct text associated with them
- Making sure all call points have text associated with them
- Checking the date and time
- Checking the programmed pager address

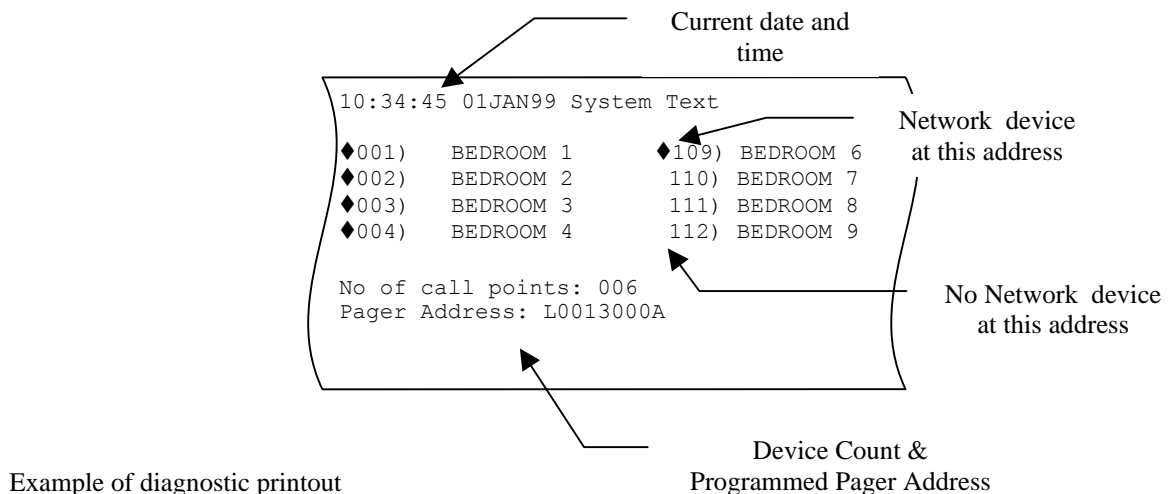

## Installation Procedures – DPU414 connected to L747.

The L747 has now taken over from the L607 and L707 printer interface. It is plug and play and detects which system it is connected to. Please follow the instructions below:

- Unpack the Equipment and check you have the following items:
  - **DPU414 Thermal Printer**
  - **L747 Universal Interface**
  - **Mains ‘plug top style’ Power supply (PSU)**
  - **Parallel Data Lead for connection between L747 & Printer**
  - **Check battery is fitted into printer (See DPU414 Operation Manual page 25)**
  - **Roll of thermal paper**
- Locate DPU414 as required within 1.5 metres of L747 and mains socket.
- Plug power supply into printer & 13 amp socket (See DPU414 manual page 12)
- Switch power supply and printer on (See DPU414 manual page 10)
- Install paper roll into printer (See DPU414 manual page 13 & 14)
- Set ALL 8 of the L747 DIP switches to the OFF position (See Below).
- Set the JP1 and JP2 jumpers on the L747 on one pin only.
- Connect parallel data cable between L747 and Printer. (Manual page 21)
- Ensure DPU414 ‘power’ and ‘on line’ lamps are lit green. (Manual page 10)
- Connect the L747 to the NETWORK + and – cables. OBSERVE POLARITY !
- After about 5 to 10 seconds the printer will print the start up and the L747 LED will flash red once per second.
- **Check time is correct. Should you need to advance or retard the hour for BST or GMT, Press and hold the BST/GMT button until the red LED stops flashing and the printer reports the hour has been advanced or retarded. (If you go over repeat the operation until the correct hour is shown)**
- The date and time is factory programmed, this can be altered using the ‘747set.exe’ software utility, a copy of which can be downloaded from the Intercall web site.
- Secure the L747 to the wall in the backbox. (See Below).
- Secure the Parallel data cable with the jack screws. (See Below).
- Download system text in the normal way. (See Below).
- Changing the position of DIL Switch 2 will make the printer print out all text stored in the system (Addresses and User ID) and it will show a large dot to the left of all addresses that have a call point connected. – Ideal for commissioning and double address testing.
- The red LED on the front of the L747 flashes once per second when receiving good data from the network. If the printer is switched off, set off line or not connected – the red LED will stop flashing. If the printer runs out of paper – The data will be stored and printed out when the new paper roll is fitted.
- The following switches can be set on the L747 to select which calls printed etc – please check with the client.
  - SW1 OFF – Print when a fault occurs (Unit failure/tamper/mains failure) (No audible alarm)
  - SW1 ON – Don’t print when a faults occurs. (No audible alarm)
  - SW3 OFF – Intercall mode (Prints Nurse Present).
  - SW3 ON – Guardian Visit mode (Prints ‘Visit’ if reset trigger button pressed)
  - SW4 OFF – Print in condensed mode for Intercall 700 (Small Characters on one line)
  - SW4 ON – Print in normal mode for Intercall 700 (Larger characters on two lines)

## Installation Procedures – Scope RS232 Serial RFTX Kit connected to L747.

The 747 is “plug and play” and detects which system it is connected to. Please follow the instructions below:

- Unpack the Equipment and check you have the following items:
  - Scope transmitter
  - L747 Universal Interface
  - Mains Lead for Scope Transmitter
  - RS232 Data Lead for connection between L747 & Scope kit (*This lead is only supplied when the Scope equipment is purchased from Intercall*). **Order Code 747SL**
  - Any additional pagers ordered
- 
- Remove the lid of the Scope transmitter and secure the unit to the wall.
  - Attach the aerial to the Scope transmitter
  - Connect the power lead to the mains supply and plug this directly into the bottom of the Scope transmitter using the IEC power socket.
  - Switch the mains supply on & check the RED LED on the bottom of the Scope transmitter
  - **Connect the integral battery in the Scope transmitter.**
  - Unpack the L747 Universal Interface and secure the backbox to the wall.
  - Set the switches on the L747 as follows:
  - SW5 ON and SW8 ON (Towards the silver colour disk Battery)
  - ALL OTHER SWITCHES OFF
  - SERIAL I/O JUMPERS JP1 and JP2 FITTED OVER BOTH PINS
  - Connect the L747 to the NETWORK + and – cables. OBSERVE POLARITY !
  - After about 5 seconds the red LED on the front of the L747 will flash once a second.
  - Connect the RS232 data lead between the L747 socket and the right hand 9 pin data socket on the bottom of the Scope transmitter.
  - Check the L747 red is still flashing and secure L747 to backbox and parallel data connectors to L747 and Scope kit with lock screws.
  - Test by making call and checking GREEN LED on scope transmitter lights for approx 1 second while transmitting to the pagers.
  - The red LED on the L747 will continue to flash all the time good network data is being received and the Scope kit does not give a ‘Busy’ Signal
  - The following switches can be set on the L747 to select which calls are sent to the pager – please check with the client.
- SW1 OFF – Page when a fault occurs (Unit failure/tamper/mains failure)  
SW1 ON – Don’t page when a faults occurs.  
SW2 OFF – Page when a call point is put into nurse present.  
SW2 ON – Don’t Page when a call point is put into nurse present.  
SW3 OFF – Page when a call point is Accepted.  
SW3 ON – Don’t Page when a call point is accepted.  
SW4 OFF – Page when a call point is reset.  
SW4 ON – Don’t Page when a call point is reset.

## Installation Procedures – Upgrading L607/L707 Printer Interface to L747

If the L607 or L707 Printer Interface has failed and you wish to replace this unit, it must be replaced with a L747 Universal Interface. The following text describes the upgrade procedure and pre-installation checks.

1. Check that the existing printer is a **DPU414** (*If the existing printer is a DPU411 or DPU40 then this will not work with the L747 and a new DPU414 must be purchased*)
2. Assuming the existing printer is a **DPU414** you will need to purchase the following items:
  - DPU414 Battery pack **Order Code E1779**
  - DPU414 Plug top power supply Order Code **Order Code E1780**
  - DPU414 Parallel Data Cable **Order Code W1788**
  - L747 Universal Interface
3. If the existing printer is a **DPU40 or DPU411** you will need to purchase the following items:
  - DPU414 Thermal Printer
  - L747 Universal Interface
4. Installation/Upgrade procedure:
  - Disconnect and remove existing **L607 / L707** Printer Interface.
  - Discard existing power and data leads between interface and printer
  - Fit batteries into the compartment in the DPU414 Printer. See DPU414 manual page 25
  - Plug top power supply plugs into 13Amp socket and rear of DPU414 Thermal Printer
  - Connect new white data cable to DPU414
  - Switch plug top power supply and leave connected to DPU414 for 24hours to charge battery.
  - Install L747 as per standard instructions.

To fit the battery into the DPU414:

- Turn the printer over, locate the batter compartment and remove the compartment cover.
- Connect the battery pack plug to the small socket in the battery compartment.
- Insert the battery pack with the label showing.
- Replace the battery compartment cover.
- **Connect the mains charger and switch on for 24 hours to fully charge the battery.**

Intercall 600	<b>617/717</b>
Intercall 700	<b>717</b>

## L717 Intelligent Power Supply Unit.

The L717 may be used with Intercall 700 & Intercall 600 systems provided all network devices were manufactured after August 2003. **The L617 600 Series Power Supply is still available for maintaining earlier Intercall 600 systems as you cannot replace the L617 with a L717 without ensuring all network devices are 600/700 compatible.** The L717 provides power and data signals for the network devices and stores the text programming information & when this is customised, it will need to be downloaded to any new display, call logger or pager interface installed on the system at a later date. **When using with an Intercall 700 with Intercom, the (A) and (B) cables do not connect to this unit.**

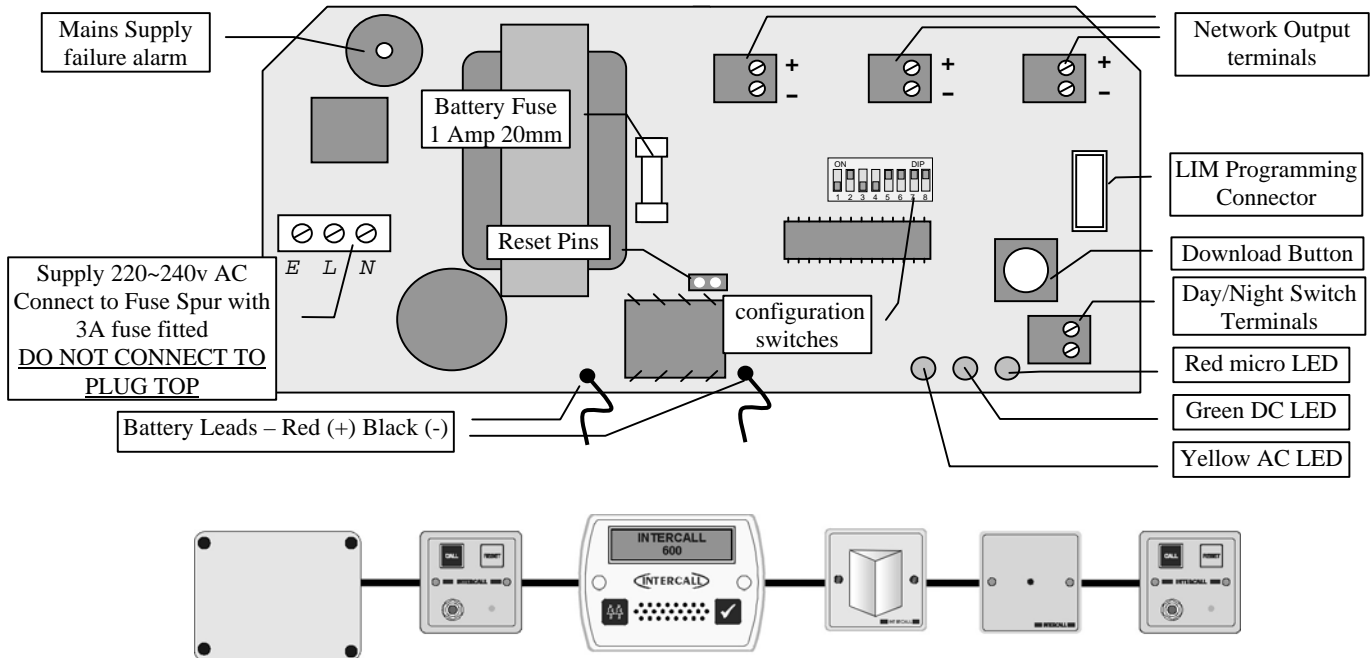

- Mains Terminals:** 220-240VAC @ 20W (Max)
- Battery Leads:** 12v, 1.9/2.1/2.4 Ah sealed lead acid battery. **OBSERVE POLARITY!**
- Output Terminals (+-):** Three pairs provided for convenience, connect to network devices.
- LIM Connector:** Connects to LIM for system text programming. (See page52)
- Configuration Switches:** See page 74 for a complete list of DIL switch settings.
- Day/Night Terminals:** By connecting a switch between these two terminals you can switch the between the two volume levels set-up on the displays. (See Pages 35)
- Download Button:** Press & hold for 10 seconds, then release, to download text to LCD displays. **THE BATTERY MUST BE CONNECTED WHEN DOWNLOADING**
- Reset Pins:** If shorted, resets the power supply and cancels all calls active on the system.
- Mains Failure Alarm:** Beeps every 3 seconds when no mains supply is present.
- Red Led:** Flashes, indicating unit is operating correctly.
- Yellow Led:** Indicates AC is present and transformer is operating.
- Green Led:** Indicates 12volt DC supply is present and fuse is intact
- Onboard Fuse:** 1Amp 20mm protection for power supply & battery.
- Installation:** Self Contained Surface Mounted Case. (See Below)
- Size & Weights:** 225 x 180 x 90 mm, 1400g

Intercall 600	✓*
Intercall 700	✓

## L7717 Large Power Supply Unit.

The L7717 is similar to the L717 Power Supply, however it has the capacity to operate an entire system and does not require the use of L737 Booster Power Supplies. The printed circuit board controller is identical to the L717 as can be seen below, however, the unit is powered from a separate 65Watt supply unit which is mounted alongside the PCB within a self contained, surface mounting, mild steel enclosure. There is space in the enclosure for a 12Volt 12AH battery. The power supply stores the text programming information & when this is customised, it will need to be downloaded to any new display, call logger or pager interface installed on the system at a later date. **When using with an Intercall 700 with Intercom, the (A) and (B) cables do not connect to this unit.** \*The L7717 may be used with Intercall 600 devices manufactured after August 2003 only.

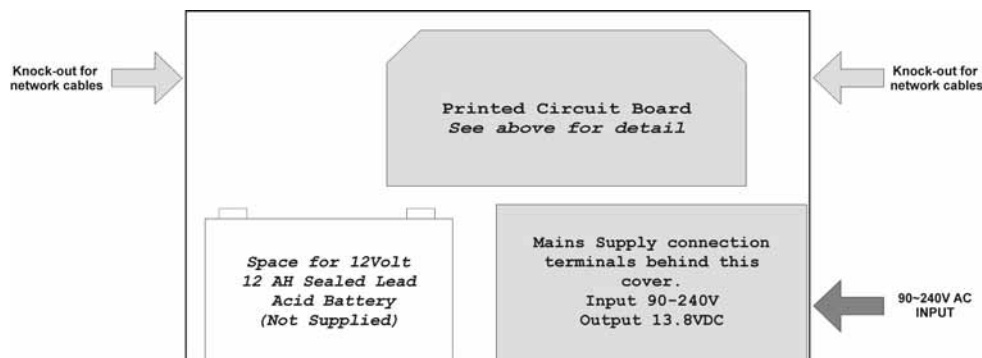
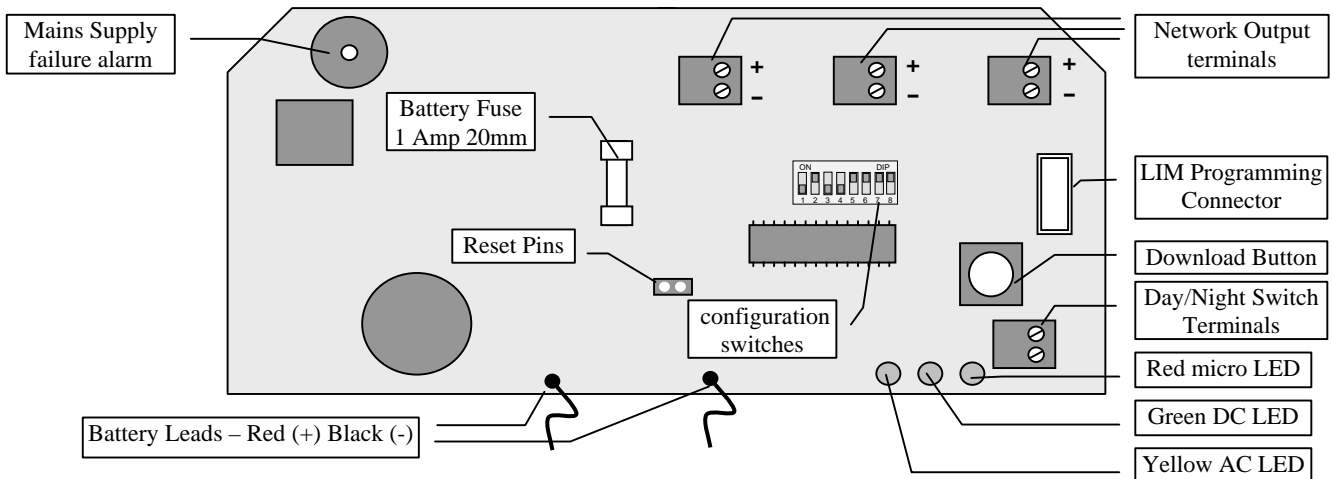

### Mains Supply Input:

Remove protective cover to gain access to these terminals.

### Battery Leads:

12v, 1.9/2.1/2.4 Ah sealed lead acid battery. **OBSERVE POLARITY!**

### Output Terminals (+-):

Three pairs provided for convenience, connect to network devices.

### LIM Connector:

Connects to LIM for system text programming. (See page52)

### Configuration Switches:

See page 74 for a complete list of DIP switch settings.

### Day/Night Terminals:

By connecting a switch between these two terminals you can switch the between the two volume levels set-up on the displays. (See Pages 35)

### Download Button:

Press & hold for 10 seconds, then release, to download text to LCD displays. **THE BATTERY MUST BE CONNECTED WHEN DOWNLOADING**

### Reset Pins:

Short together momentarily to reset system & all active calls.

### Mains Failure Alarm:

Beeps every 3 seconds when no mains supply is present.

### Red Led:

Flashes, indicating unit is operating correctly.

### Yellow Led:

Indicates AC is present and transformer is operating.

### Green Led:

Indicates 12volt DC supply is present and fuse is intact

### Onboard Fuse:

1Amp 20mm protection for power supply & battery.

### Installation:

Self Contained Surface Mounted Case. (See Below)

### Size & Weights:

370mm x 260mm x 110 mm 4.5Kg

Intercall 600	✓
Intercall 700	✓

## L622 Standard Call Point.

The L622 is the standard call point for the Intercall 600 non audio system. It can generate up to 6 independent levels of call which are indicated by the integral twin colour re-assurance LED. There is a 'call follower' sounder which sounds when the call point is in 'staff present' mode to inform staff of another call. The industry jack socket will accept any closing contact input from pear leads, pressure mats, radio triggers and a host of other triggering devices. The X and L terminals are used to connect to ceiling pull switches. Options which must be specified when ordering include; magnetic key reset, (L622M) Please refer to page 9 for a guide on the use of the call point. For Non-Latching and remote reset applications, please see the L634 on page 45.

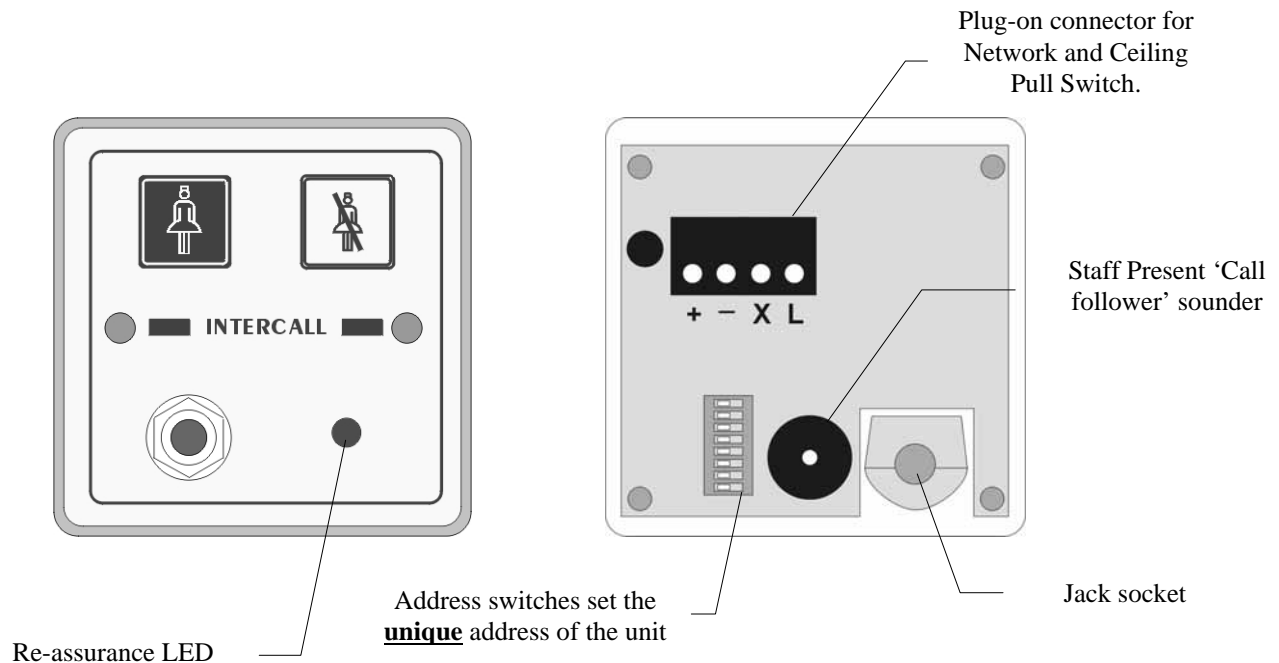

**Network Terminals:** Connect to the Intercall 600 (2 wire) Network. [+,-] **OBSERVE POLARITY**

**X Terminal:** Standard Call Input which automatically generates System User-id 3. This allows the input to have a secondary description, for example 'Ensuit' or 'Ceiling Pull Cord'.

**Re-assurance LED:**

- Slow Red flashing – Standard Call
- Fast Red flashing – Priority Call\*
- Slow Red/Green flashing – Assistance Call
- Rapid Red flashing – Emergency/Crash Call
- Green flashing - Accepted Call – Staff on their way
- Constant Green – Nurse Present Mode

\* When running from 700 Series Power Supply Only.

**L Terminal:** LED Output for ceiling pull switches with built in re-assurance lights.  
**Warning:** This terminal must not be connected to any other device without prior consent from our technical support department.

**Pear lead Socket:** Industry standard socket that will accept any normally open switch.  
 This socket can accept input from pear leads, pressure mats, radio triggers etc.

**Installation:** Flush or surface mount in standard 'single size' electrical backbox.

**Size & Weights:** 80 x 80 x 40 mm, 70g



Intercall 600	✓
Intercall 700	✓

## L622AN310 Call Point with Extended Inputs & Outputs.

The L622AN310 is a modification of the standard L622 unit with additional terminals to provide an emergency call generation for WC or en-suit bathroom ceiling pull switches and L2/X3 terminals for SRP connection. (As per L722) Operation of the unit is identical to the L622 Standard Unit. It can generate up to 6 independent levels of call which are indicated by the integral twin colour re-assurance LED. There is a 'call follower' sounder which sounds when the call point is in 'staff present' mode to inform staff of another call. The jack socket will accept any closing contact input from pear leads, pressure mats, radio triggers and a host of other triggering devices. The X and L terminals are used to connect to ceiling pull switches. Options which must be specified when ordering include; magnetic key reset, (L622MAN121) Please refer to page 9 for a guide on the use of the call point. For Non-Latching applications, please see the L634 on page 45.

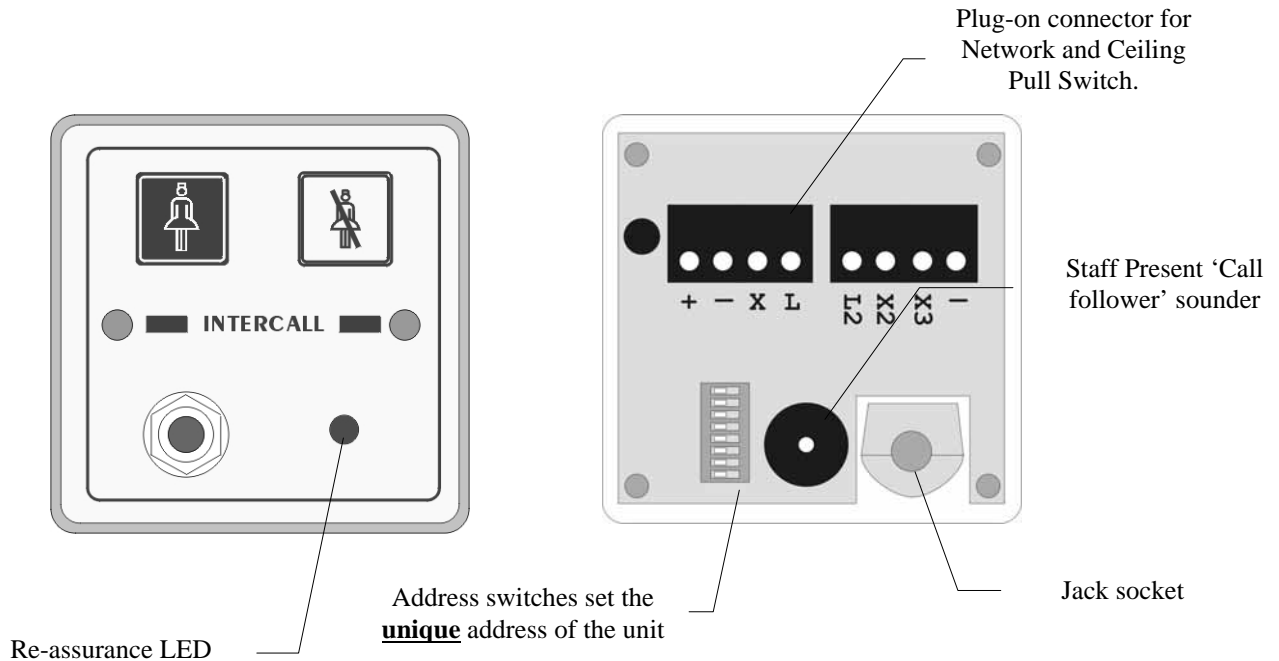

**Network Terminals:** Connect to the Intercall 600 (2 wire) Network. [+ , -] **OBSERVE POLARITY**

**X Terminal:** Connect external normally open contacts between here and Network –ve to trigger the call point into standard call.

**X2 Terminal:** Connect external normally open contacts between here and Network –ve to trigger the call point into emergency call from the En-suit or Bathroom.

**Re-assurance LED:**  
 Slow Red flashing – Standard Call  
 Slow Red/Green flashing – Assistance Call  
 Rapid Red flashing – Emergency/Crash Call  
 Green flashing - Accepted Call – Staff on their way  
 Constant Green – Nurse Present Mode

**L Terminal:** Red LED Output for ceiling pull switches with built in re-assurance lights.

**L2 Terminal:** Green LED Output for SRP (Slave Reset Points).

**Pear lead Socket:** Industry standard socket that will accept any normally open switch.  
*This socket can accept input from pear leads, pressure mats, radio triggers etc.*

**Installation:** Flush or surface mount in standard 'single size' electrical backbox.

**Size & Weights:** 80 x 80 x 40 mm, 70g

Intercall 600	✓
Intercall 700	✓

## L733 Door Monitoring & Access Control Point.

The L733 replaces the L722DK as the Door Monitoring Point for the Intercall 600 and Intercall 700 systems. It is used to protect fire doors, entrance & exit doors or other sensitive areas. The door is fitted with a magnetic contact (not supplied), which is used to trigger the call point and activate the call system. The unit is controlled with the use of a key token, which performs all functions when brought near the token detection area on the fascia. The unit features standard call and emergency call generation, integral 20 second exit timer with audible bleep and mode jumper to prevent sensitive or dangerous exit doors being permanently left open. In mode I & II, the unit automatically re-arms when the door is closed. In mode III, the unit must be manually re-armed. The unit is supplied with one magnetic token.

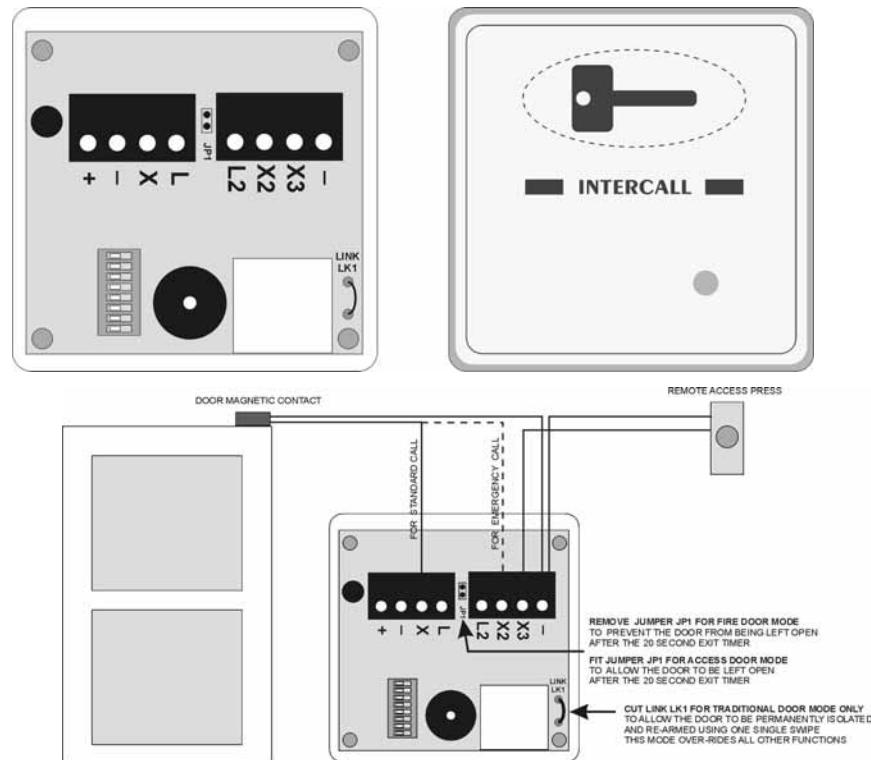

- Network:** Connect to the Intercall 600 or 700 (2 wire) Network. [+ , -] OBSERVE POLARITY
- X Terminal:** Standard Call Input, if the unit goes into alarm it will generate a standard call.
- X2 Terminal:** Emergency Call Input, if the unit goes into alarm it will generate an emergency call.
- X3 Terminal:** Remote authorised access press button input, this mimics the functions of the token area in a remote location (eg external side of the door)
- Exit Timer:** To allow authorised personnel to use the door without generating an alarm. Before opening the door, swipe the token area once, the green LED will flash and the sounder will pulse. The door may now be opened, however, if the door remains open after the 20 seconds, the alarm will sound. If the door is opened & shut within 20 seconds, the unit will re-arm immediately.
- JP1 Fitted:** **Mode I:** This allows the door to be permanently left open. Before opening the door, swipe the token area twice, the sounder stops & the LED is continuously green. The door can now be opened and left open without an alarm being generated. Once the door is shut, the unit will automatically re-arm immediately.
- JP1 Removed:** **Mode II:** This prevents the door from being permanently left open & disables the double swipe feature.
- LK1 Cut:** **Mode III:** This removes the exit timer and converts the single swipe into on/off mode. Before opening the door, swipe once to isolate the door & the green LED will light. Opening and closing the door while isolated has no effect. Close the door and swipe to re-arm the unit.
- Alarm Reset:** The alarm is reset but closing the door and swiping the token area once.
- Installation:** Flush or surface mount in standard 'single size' electrical back-box.
- Size & Weights:** 80 x 80 x 40 mm, 70g

Intercall 600	✓
Intercall 700	✓

## L737 Universal Booster Power Supply Unit.

The Booster Power Supply unit is designed to increase the permitted number of units and quantity of cable that can be used on any one system. Only one master supply may be connected on any one system but several booster units may be connected as required. The input of the all booster unit(s) must be connected directly to the output circuit of the master and not 'daisy chained'. (See diagrams below) You must not make any connection that will effectively 'short out' the L737 input +ve and output +ve. When installing a system that requires a booster, always load the booster(s) output with more cable than the master. You may locate the Booster Power Supply either alongside the master unit or on the next floor/wing etc.

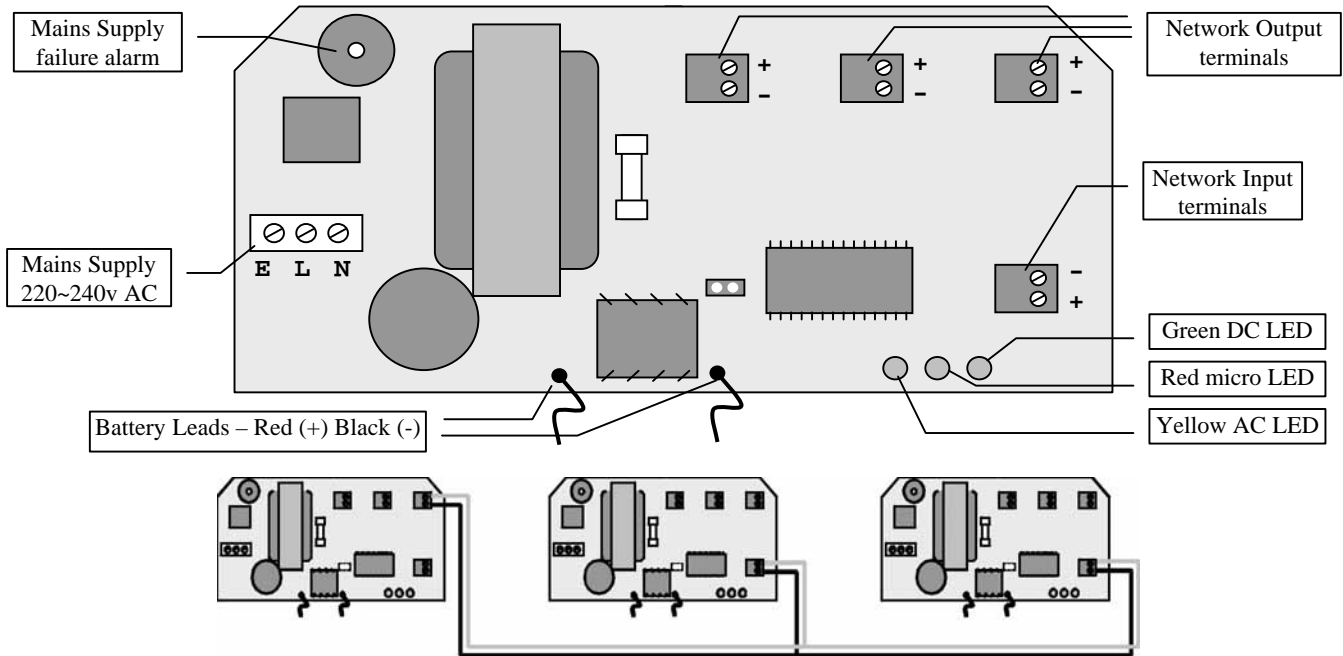

*The input to all Booster PSU's must be connected to the output of the Master PSU*

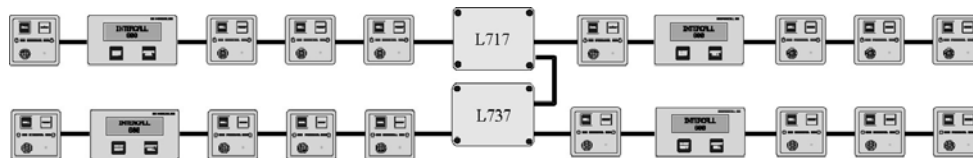

*Use a Booster PSU to split the cable and system loading*

- Mains Terminals:** Live , Neutral , and Earth, 220~240v AC via a 3 Amp fused spur outlet.
- Battery Terminals:** Flying leads with spade terminals for 12v, 1.9/2.1/2.4 Ah battery.  
**Reverse Connection of battery will destroy unit.**
- Output terminals (+&-):** Three pairs provided for convenience, connect to network devices.  
**For Intercall 700, the A & B cables are simply joined input to output.**
- Input Terminal:** Connect to output circuit of master power supply.
- Reset Pins:** If shorted, resets the booster power supply.
- Mains Failure Alarm:** Beeps continuously when no mains supply is present and at power on reset.
- Red Led:** Flashing - booster running. Off – network input failure.
- Yellow Led:** Indicates mains AC supply is present.
- Green Led:** Indicates 12volt DC supply is present and fuse is intact.
- Onboard Fuse:** 1Amp 20mm protection for power supply.  
*(The charger current limit is set at 1.6 Amps)*
- Installation:** Self Contained Surface Mounted Case. (See Below)
- Size & Weights:** 225 x 180 x 90 mm, 1400g

Intercall 600	✓
Intercall 700	✗

## L628 LCD Display Unit.

A display unit is required in every location where calls are to be shown and the alarm is to sound. The L628 features two-line LCD display with backlight and a multi-level adjustable alarm. (See page 10 for more information) It is capable of sounding a different tone for selected call points (doors, drug cupboards, telephone, etc) and only displaying specific call points (*Zoning*) if required. More information can be found from page 57. There is an open collector output, which can be connected to the RB1 Relay Board [See Page 40] or used to directly trigger external equipment. All displays are identical but can be configured on site to operate independently.

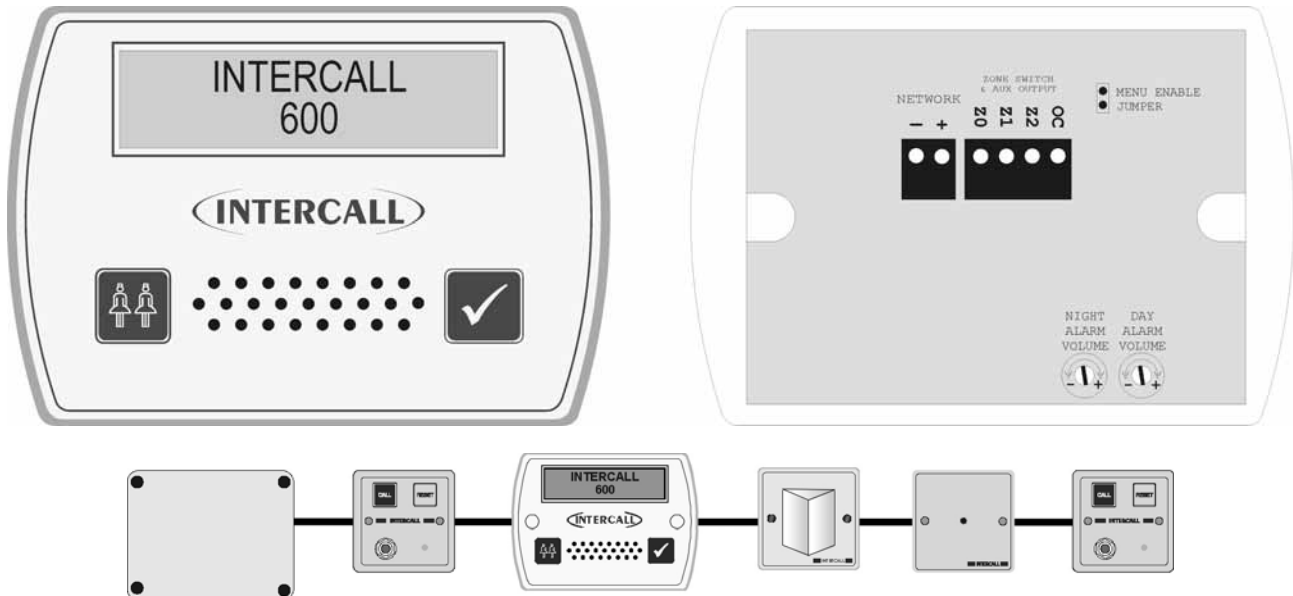

**Network Terminals:** Connect to the Intercall 600 (2 wire) Network. [+ , -] OBSERVE POLARITY

**Z0, Z1, Z2:** Connect to zone switch or wire link (See 'Zone Switch Connection' Below)

**OC Output Terminal:** Open collector output active continuously when the alarm is sounding.  
**Note: Rating 12vDC 100mA. Minimum [ON] resistance = 100 Ohms.**  
*The OC terminal may be used to trigger an external device directly, which will accept this type of input. Alternatively you may connect this terminal to a **RB1 Relay Board** which will provide normally open & normally closed 'dry' contacts.*

**Night Alarm Setting:** This controls the alarm volume when in 'night' mode.

**Day Alarm Setting:** This controls the alarm volume when in 'day' mode.  
*To change between the 'day' and 'night' mode you will need to connect a switch to the DAY/NIGHT terminals on the Master Power supply. (See page 29)*

**Menu Enable Jumper:** Remove to prevent access to the display menus and disable system download.

**Sounder output:** Typical Maximum 92db@30cm.

**Zone Switch:** This text is intended as a technical reference only and details of zoning are discussed on page 61. When a display is required to only sound for specific call points, we need to connect a switch or permanent wire link to the 'Z' terminals. The following connections force the display to use the address windows that are programmed on site:

Z1 Not Connected,	&	Z2 Not Connected	= Global (Sound for all calls)
Z1 Not Connected	&	Z2 Connected to Z0	= Use Address Window C
Z1 Connected to Z0	&	Z2 Not Connected	= Use Address Window B
Z1 Connected to Z0	&	Z2 Connected to Z0	= Use Address Window A

**Installation:** Flush mount - use standard 'double size' electrical backbox. Surface mount use BB1 (See page 21). Connects to system two core and optional zone switch and auxiliary devices.

**Size & Weights:** 80 x 140 x 40 mm, 200g

Intercall 600	✘
Intercall 700	✔

### L748 Corridor LED Display Unit.

The L748 Corridor LED Display is ideal for where calls need to be easily and clearly seen by staff on the move. It may be used in several applications including hospitals, doctors' surgeries and larger nursing homes. Call information is very clearly displayed on the illuminated 16 character display. The integral alarm is adjustable for day and night volumes. The display may be configured to show a standing message or appear "off" when no calls are active on the system.

The unit is compatible with the **INTERCALL 700** protocol only and shows the same text as the LCD display units. The unit can either operate as the only type of display on the system or can be used in conjunction with the standard LCD units. Operation of the unit is similar to the standard LCD units, with all calls numbered in queue order. Emergency and Attack calls are "flashed" on the display to show the higher priority while normal, assistance and priority calls are stored in memory but not displayed until the higher priority calls are dealt with. There are no user controls on the unit, however, the display menus controls are available and the unit has a unique display menu structure for configuration. These menus are configured using the two buttons in a similar manor to the standard display. For more information on the L748 Display Menus, please refer to page 61



FRONT VIEW OF DISPLAY

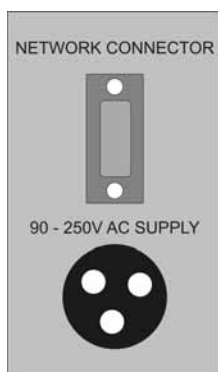

END VIEW OF DISPLAY

Mk1 Unit

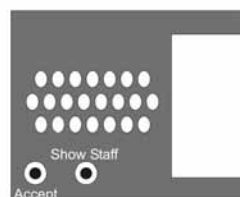

END VIEW OF DISPLAY  
Mk2

Mk2 Unit

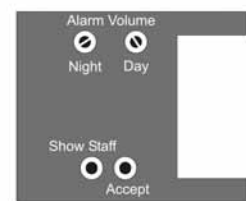

CONTROLS & PRESETS  
Mk2

There are two versions of this unit, the earlier Mk1 unit is directly supplied with a 90-250VAC-15W (max) supply whereas the Mk2 unit is supplied with a separate 5V DC Power Supply with an input voltage range of 90-230VAC.

**Installation:**

The unit is supplied with a mounting bracket, which is secured to the wall first and the display is mounted onto the bracket, for straightforward installation and maintenance purposes.

**Connections (Mk1):**

The Mk1 L748 is supplied with 'open ended' 3 metre mains supply lead and 3 metre data lead, both of which are terminated with suitable connectors to mate with the L748.

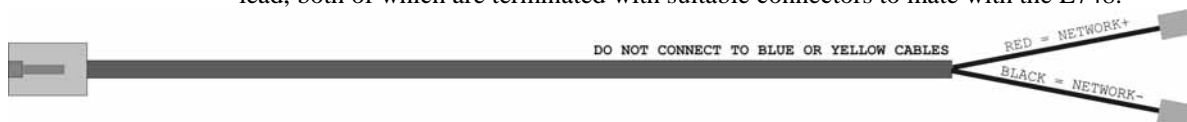

**Connections (Mk2):**

The Mk 2 L748 is supplied with a data cable terminated with a RJ11 connector (Shown above) and 'open ended' spade connectors & separate 5V Power Supply with IEC mains lead. The network + & - connects to the open ended red and black leads from the RJ11 connector (do not connect to the Yellow or Blue cables) The 5V power supply simply plugs into the mating connector on the L748.

**Character Size:**

H60mm x W40mm Red Illumination.

**Physical Size:**

W910mm x H95mm x D60mm (excluding mounting bracket)

Intercall 600	✓
Intercall 700	✓

## L746 Addressable Overdoor Light.

The L746 Overdoor light is an optional item usually located above a door or end of corridor to indicate the status of the call point(s) within. It is fitted with twin ultra-bright LED's which mimic the re-assurance indicator on the call points. The unit is fully addressable and requires no separate connection to the call point(s). It is simply set to the address range of the call points it is required to indicate. There are with two banks of DIL switches, one set to the lowest call point address and another set to the highest address. As the unit can only show one type of call at a time, calls are priorities as follows: Attack+Emergency/Assistance/Call. The unit is available with an integral sounder Order code **L746S**.

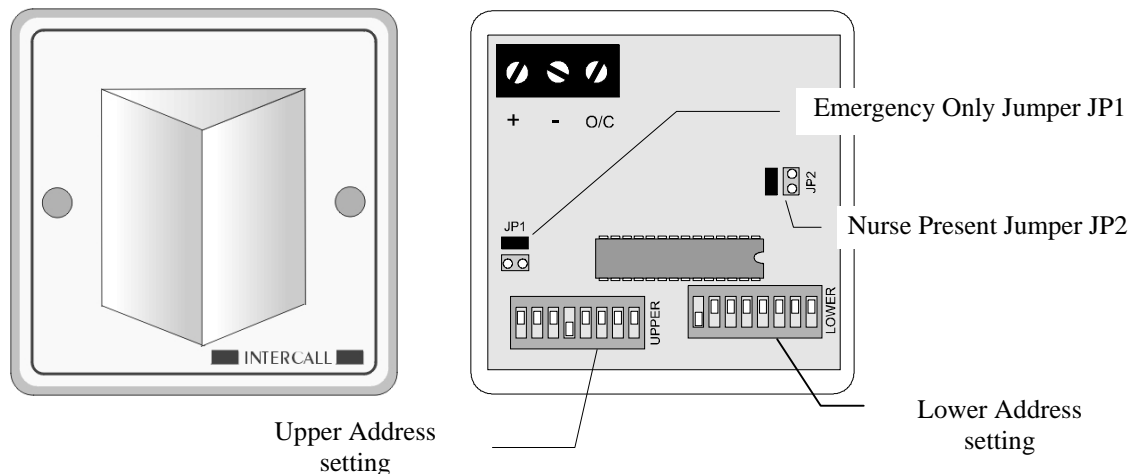

**Network Terminals:** Connect to the Intercall 600 or 700 (2 wire) Network. [+ , -] **OBSERVE POLARITY**

**OC Output Terminal:** Open collector output active continuously when the alarm is sounding.  
**Note: Rating 12vDC 100mA. Minimum [ON] resistance = 100 Ohms.**  
*The OC terminal may be used to trigger an external device directly, which will accept this type of input. Alternatively you may connect this terminal to a **RBI Relay Board** which will provide normally open & normally closed 'dry' contacts.*

**Jumper JP1:** **Emergency Only Jumper** - When fitted, the unit will *only* indicate emergency calls.

**Jumper JP2:** **Nurse Present Jumper** - When fitted, the unit will *not* indicate nurse present status.

**Light Patterns:**

Standard/Priority Call	-	Flashing Red Indication.
Attack / Emergency Call	-	Rapid Flashing Red Indication.
Staff Present	-	Continuous Green Indication.
Accepted/Spoken Call	-	Flashing Green Indication.
Assistance Call	-	Alternative Red/Green Indication.
Tamper	-	Slow Alternative Red/Green Indication.

**Lower Address :** Sets the lowest call point address that the light will respond to.

**Upper Address :** Sets the Upper call point address that the light will respond to.

*The L746 will respond to all call points between the lower & upper addresses with the highest priority level of call. Overdoor light settings may overlap so that more than light will respond to several call points. **If the unit is required to respond to a single call point address, set both lower and upper DIL switches to the same address.***

**Installation:** Flush or surface mount in standard 'single size' electrical backbox. (See page 21). Connects to system two core and optional ceiling pull switch and auxiliary devices.

**Size & Weights:** 80 x 80 x 40 mm, 70g

Intercall 600	✓
Intercall 700	✓

## L747 Universal System Interface.

The L747 Universal System Interface can be used to output system activity in various formats. In 'printer mode' it is used with the **DPU414 Thermal Printer** to provide a printed record of all system events, with date & time. In 'Pager mode' it is used with the **RFTX Scope Paging Equipment** kit to provide alphanumeric paging output, details of which are on page 39. In 'PC mode' it is used with the **Windows Call Management Software** which is a comprehensive PC package designed to manage resident call information. In addition, the unit contains a diagnostic printout mode, which can provide a hard copy of all programmed text and active network devices, which is ideal as a complete 'system address test'. **See Page 25 for more information.**

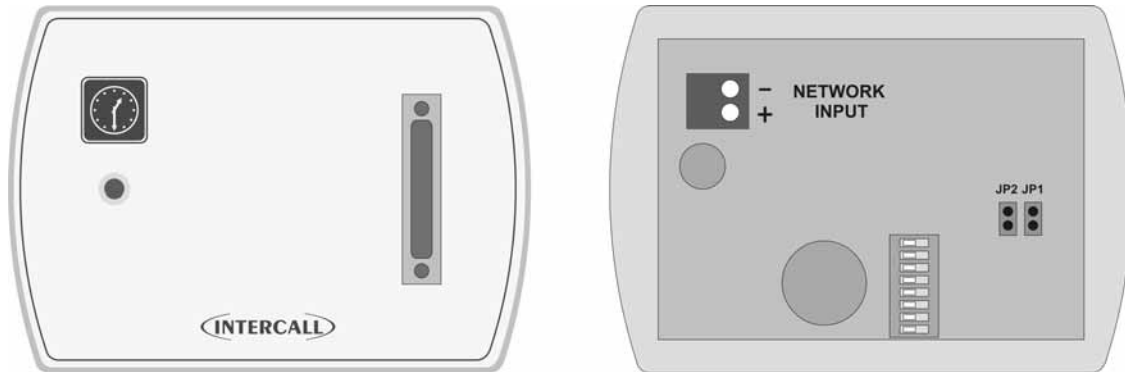

Pin	Description	Pin	Description	Pin	Description	Pin	Description
1	Parallel Strobe Output	6	Parallel Data 4 Output	11	Parallel Busy Input	16	Not Connected
2	Parallel Data 0 Output	7	Parallel Data 5 Output	12	Not Connected	17	RS232 RTS Output
3	Parallel Data 1 Output	8	Parallel Data 6 Output	13	RS232 CTS Input	18	Not Connected
4	Parallel Data 2 Output	9	Parallel Data 7 Output	14	RS232 TX Output	19-25	Signal Ground
5	Parallel Data 3 Output	10	Not Connected	15	RS232 RX Input		

Note: Data Cables are supplied with DPU414, RFTX Scope kit & PC Software kit.  
Please refer to page 74 for cable connection details.

Switches	Pager Mode	Printer Mode	CMS LITE
SW1 Off	Print & Page for system faults and lost devices		OFF or ON
SW1 On	Don't Print or Page for system faults and lost devices		OFF or ON
SW2 Off	Page for Nurse Present	Change SW2 position to print diagnostic printout	OFF
SW2 On	Don't Page for Nurse Present		-
SW3 Off	Page for Accept Call	Intercall "Staff Present" mode	OFF
SW3 On	Don't Page for Accept Call	Guardian "Visit" mode	-
SW4 Off	Page for Call Reset	Condensed Printout (700 only)	OFF
SW4 On	Don't Page for Call Reset	Condensed Printout off	-
SW5	ON	OFF	ON
SW6	OFF	OFF	ON
SW7	OFF (See Note 1 below)	OFF	OFF
SW8	ON	OFF	ON
JP1 JUMPER	ON (Fitted)	OFF (Not Fitted)	ON (Fitted)
JP2 JUMPER	ON (Fitted)	OFF (Not Fitted)	OFF (Not Fitted)

**All other combinations of switches are illegal and may cause spurious results**  
Note 1: SW7 Controls RS232 Baud Rate Off = 1200 Baud On = 2400 Baud.

**Network Terminals:** Connect to the Intercall 600 or 700 (2 wire) Network. [+,-] **OBSERVE POLARITY**

**I/O Connections:** 25way D female with both parallel or serial connections available. Pin out as above.

**JP1 & JP2 Jumpers:** Both must be fitted to enable RS232 programming and RS232 data output.

**Programming:** Using the '747SET' software supplied with the LIMKIT, the date, time & pager CAP code may be configured using the L747SL Serial Lead.

**Time Set button:** **Printer mode Only** – Touch button under label to advance hour for British Summer Time. In the Spring, press and hold until LED stops flashing, release button and printer will advance hour. Repeat operation for converting back to GMT in the Autumn. *If an hour is advanced or retarded by mistake, repeat operation 23 times to get correct hour setting.*

**Red/Green LED:** Green indicates power and transmit data, red flashes to indicate unit operational. If the output device is not connected or is giving a 'busy' signal, the Red LED will not flash.

**Installation:** Flush mount - use standard 'double size' electrical backbox. Surface mount - use **BB1**.

**Size & Weight:** 165 x 116mm 185g

Intercall 600	✓
Intercall 700	✓

### Alphanumeric Paging Kit.

The Alphanumeric Paging Kit is used in conjunction with the L747 Universal System Interface to provide alphanumeric paging for both the Intercall 600 and 700 systems. The kit comprises; Paging transmitter with integral 240V ac supply and back up battery, power lead, RS232 data connection lead, ¼ wave antenna and one alphanumeric pager. Please read and retain all relevant documentation supplied with the transmitter and pager. Your attention is drawn to the licensing requirements of this type of equipment and the package should contain all application forms.

The standard scope transmitted supplied by us is fitted with a RS232 data interface and a RS232 data lead for direct connection to the L747 Interface.

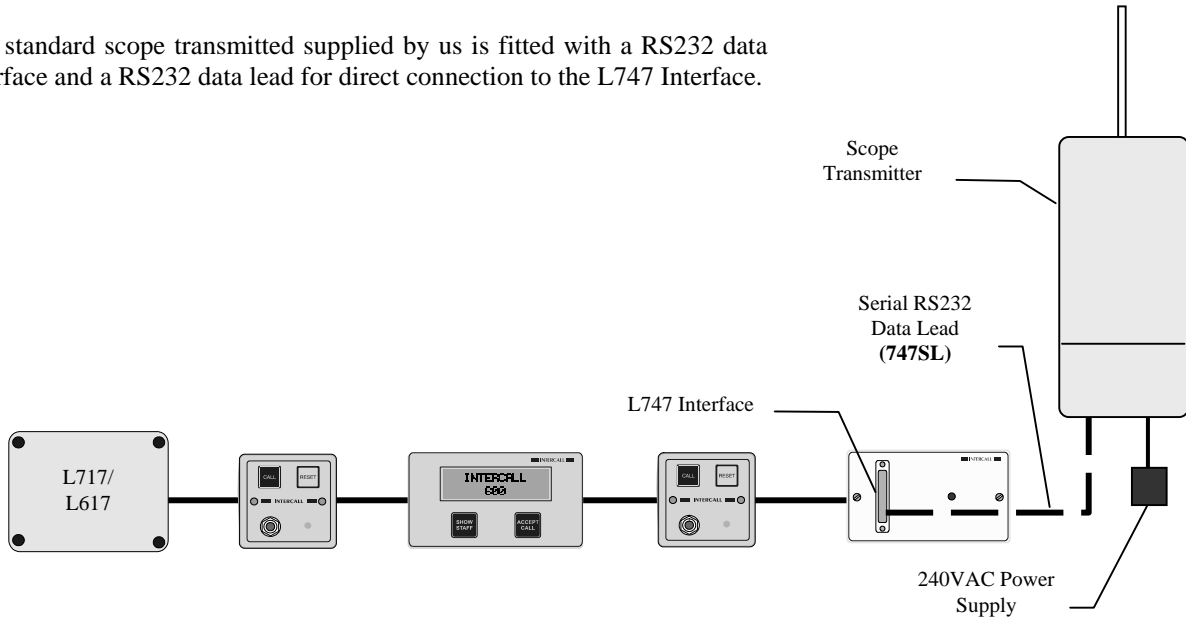

#### How the pagers will display the calls:

##### Intercall 600

BEDROOM 323  
CALL

Intercall 600 Standard Call

BEDROOM 323  
EMERGENCY

Intercall 600 Emergency

BEDROOM 323  
RESET

Intercall 600 Reset Call

BEDROOM 323  
CALL  
MARY JONES

Intercall 700 Standard Call  
with user ID

BEDROOM 323  
CALL  
NO USER ID

Intercall 700 call with no  
user ID

BEDROOM 323  
ATTACK  
USER No 54

Intercall 700 Attack call  
with user ID

Pagers are supplied with full operating instructions and modes of operation. Additional pagers are available part number **RAP**. However it is important to record the serial number of the transmitter, as this number will need to be quoted when additional pagers are ordered for existing systems.

By using the Intercall 700 PC based call management software, it is possible to route the calls from individual callers to specific members of staff. The PC interface to the Intercall system is via the L747.

Using the LIMKIT it is possible to program the standard L747 pager CAP code (Pager Address) sent to the pager transmitter.



Intercall 600	✓
Intercall 700	✓

## RB1 Relay Board.

The RB1 Relay board converts the O/C output from the LCD Displays (L628,L758) and L746 Overdoor Light into 'Normally Open' and 'Normally Closed' contact sets. The unit may also be configured by the factory to provide time delays for some access door applications. It may also be used to trigger a call point from an external voltage (such as door bells etc). The unit is fitted with a 'T' 12v output which may be used to drive low current devices from the network.

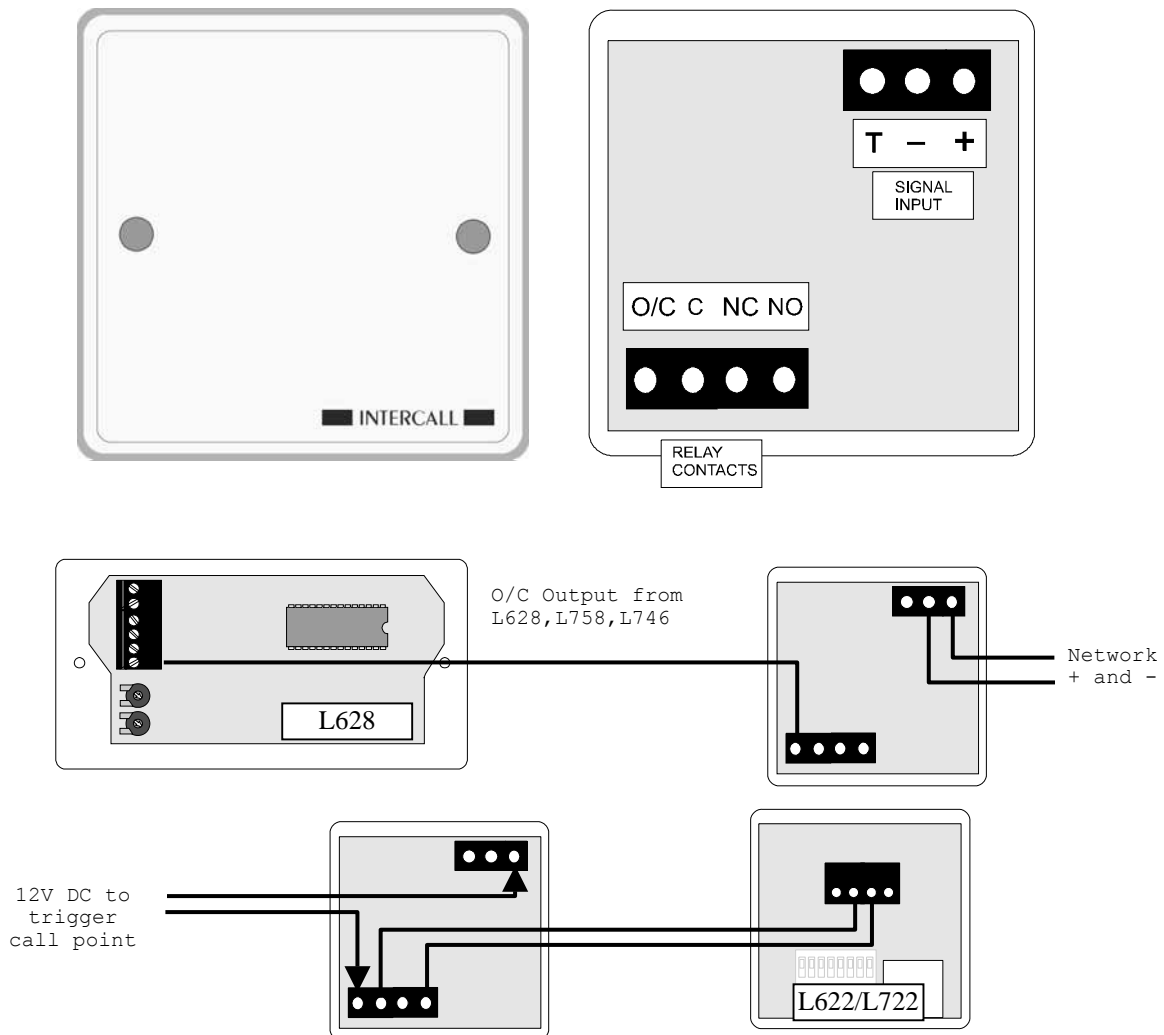

**Network Terminals:** Connect to the Intercall 600 or 700 (2 wire) Network. [+,-] OBSERVE POLARITY

**T Terminal:** 12volt DC output which may be used to drive external equipment which requires a DC supply. **MAXIMUM OUTPUT LOAD: 12VOLTS 10mA.**

**O/C Terminal:** Open collector input from display or overdoor light to trigger on-board relay.

**C:** Relay Common contact

**NO:** Relay 'Normally Open' contact

**NC:** Relay 'Normally Closed' contact

**MAXIMUM RELAY CONTACT RATING: 24 VOLTS DC 500mA.**

**Installation:** Flush or surface mount in standard 'single size' electrical backbox. (See page 21). Connects to system two core and optional ceiling pull switch and auxiliary devices.

**Size & Weights:** 80 x 80 x 40 mm, 70g

Intercall 600	✓
Intercall 700	✓

## L714 Remote Sounder with Relay.

The Remote Sounder is designed for use in areas where an alarm signal is required to attract attention but no indication of call location is required. The sounder is similar in operation to the LCD Display Unit with a multi level adjustable alarm but has only limited zoning facilities. Any assistance or emergency call on the system will over-ride the standard call tone. The unit may be configured to respond to all call levels or emergency and attack calls only.

There is an on-board relay with normally open and normally closed 'dry' contacts.

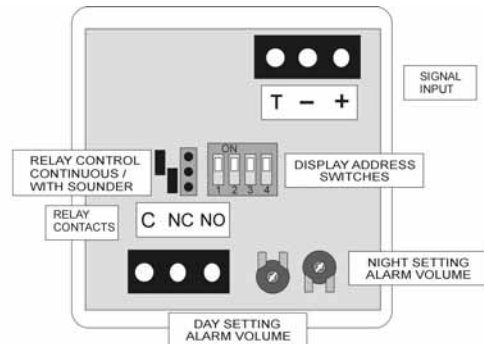
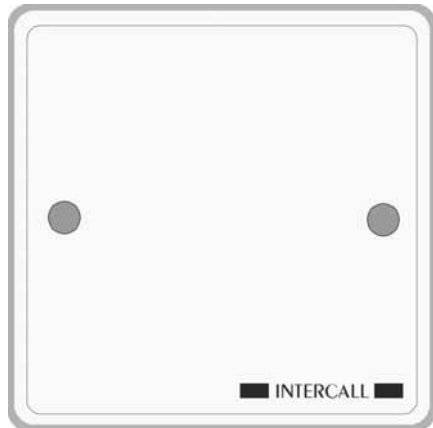

SOUND FOR ALL CALLS								
DISPLAY ADDRESS:	0	1	2	3	4	5	6	7
SOUND FOR EMERGENCY ONLY								
DISPLAY ADDRESS:	0	1	2	3	4	5	6	7

**Network Terminals:** Connect to the Intercall 600 or 700 (2 wire) Network. [+ , -] OBSERVE POLARITY

**C Terminal:** Common terminal for relay contacts.

**NO Terminal:** Normally Open contact for relay.

**NC Terminal:** Normally Closed contacts for relay.

**Note:** *Relay Contact Rating = 24vDC 600mA.*

**SW1,2,3:** **Display Address.** These set the "Display Address" setting for the remote sounder. They are only used on a system that is to be zoned. *The "Display Address" settings enable an address window to be set up on one display copied to all displays and remote sounders set to the same "Display Address". Please refer to page57 for more information on zoning.*

**SW4:** **Mode.** When OFF the sounder will operate for Emergency and Attack calls only.

**Control Jumper:** This jumper controls the operation of the on-board relay. When in the SOUND position, the relay will operate with the sounder. When in the PAGE position, the relay will operate continuously all the time a call is active on the system.

**Night Alarm Setting:** This controls the alarm volume when in 'night' mode.

**Day Alarm Setting:** This controls the alarm volume when in 'day' mode. *To change between the 'day' and 'night' mode you will need to connect a switch to the DAY/NIGHT terminals on the Master Power supply. See page57.*

**Sounder output:** Typical Maximum 81db@30cm.

**Installation:** Flush or surface mount in standard 'single size' electrical backbox. (See Page 21). Connects to system two core and optional zone switch and auxiliary devices.

**Size & Weights:** 80 x 80 x 40 mm, 70g.

Intercall 600	✓
Intercall 700	✓

### DPU414 Thermal Printer.

The DPU414 Printer is used in conjunction with the L747 to provide a permanent record of all system activity together with the date and time. The unit is supplied with parallel data lead for connection to the L747, separate mains ac power supply and integral back up battery. Please unpack the printer carefully and retain the DPU414 operation manual for future reference. *Please see page 38 for more information on the L747 Interface.*

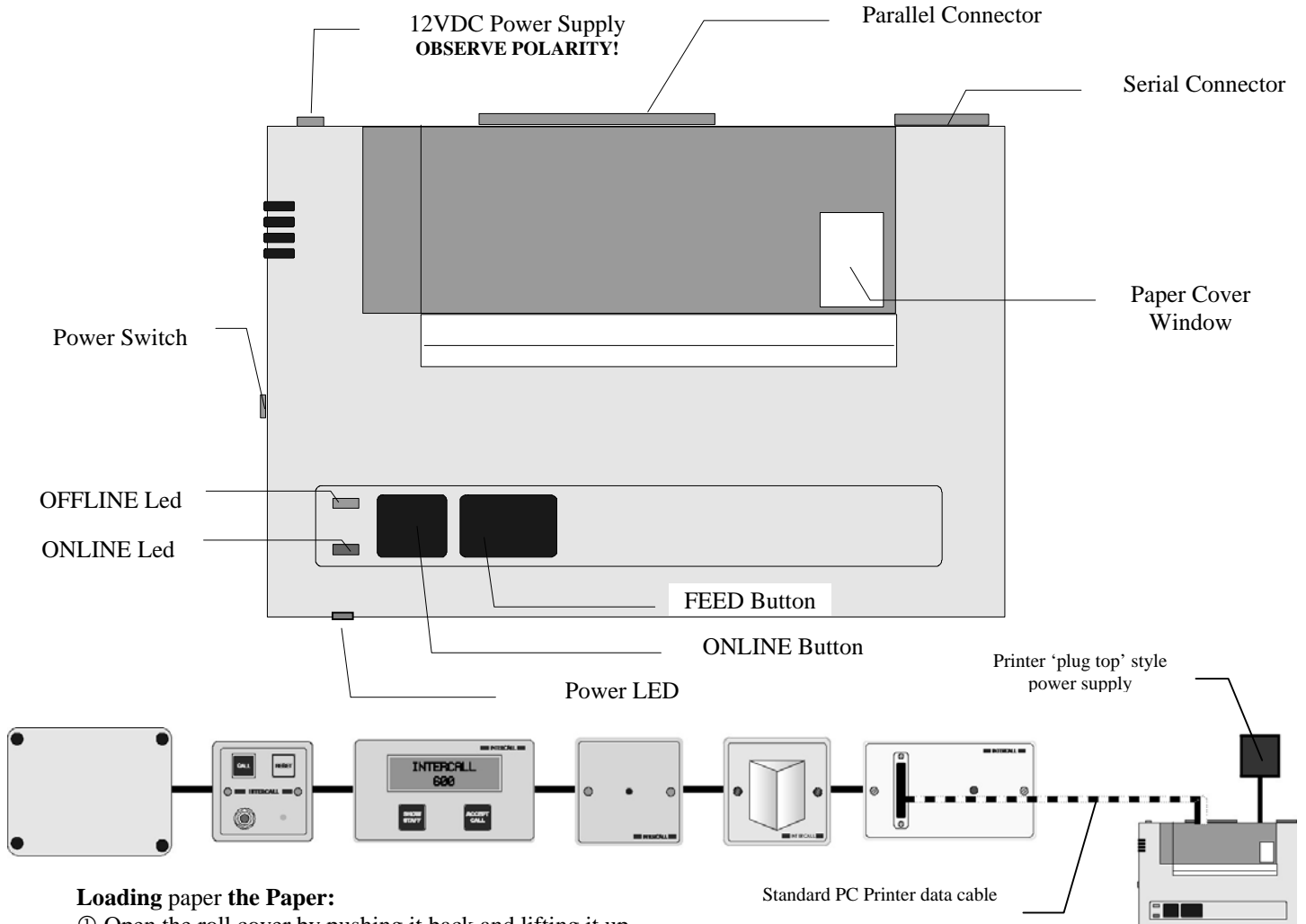

#### Loading paper the Paper:

- ① Open the roll cover by pushing it back and lifting it up.
- ② Unwrap the paper roll and cut the paper end straight across.
- ③ Make sure the paper is the correct way round, with the glossy side showing.
- ④ Push the tip of the paper into the inlet at the bottom of the paper holder, until the auto-loader catches it.
- ⑤ The auto paper feeder will pull through 10cm of paper which will show from the paper outlet.
- ⑥ When the paper has loaded successfully, Press the ON LINE button so that the Green 'ON LINE' LED is lit.
- ⑦ Close the paper roll cover and pull it towards the front of the printer to lock it.

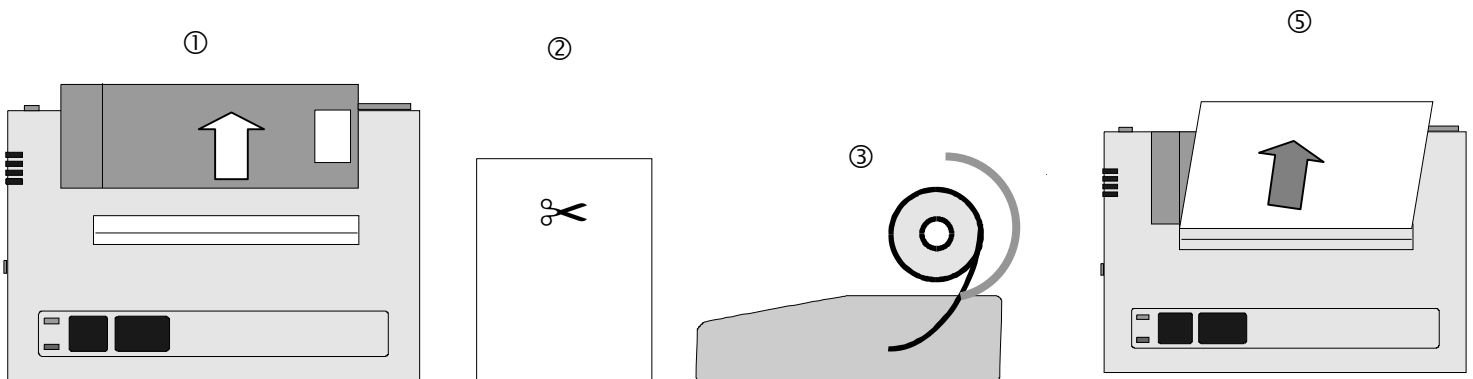

Intercall 600	✓
Intercall 700	✓

## FJB2 Fused Junction Board.

The FJB2 replaces the earlier FJB1 and provides four 'spur' outputs from the network spine with each output incorporating a over current/voltage and reverse polarity protection device. A front panel mounted red/green LED indicates the condition of the internal fuses and continuously monitors the network data signals. Individual fuse failure LED's are mounted on the reverse of the unit and in the event of a cable fault, on one of the outputs, the 'spur' will be isolated without disabling the entire cable network. *Please refer to page 20 for more information on the use of this unit.*

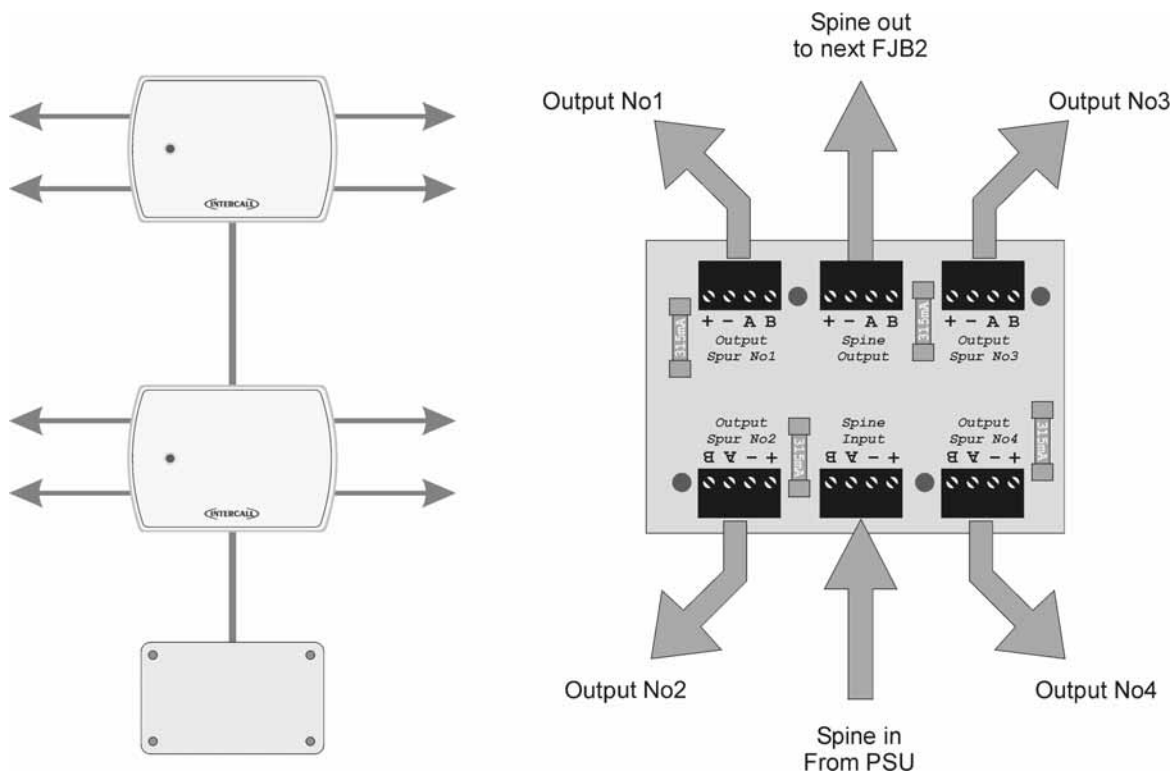
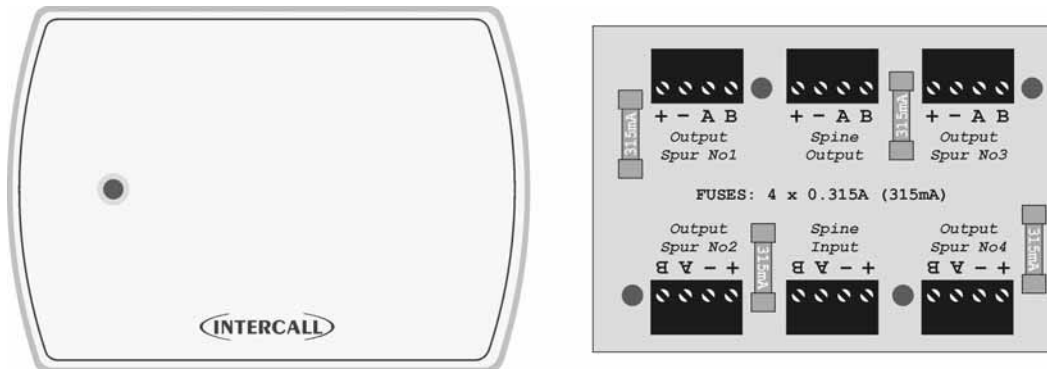

**Input / Output Terminals:** Connect to the network spine and can be daisy channed as shown above.  
**Note:** *The two Input/Output terminals are not protected or monitored.*

**Output(s)1,2,3,4:** Individually fused and monitored network outputs.

**Fuses:** 4 off 315mA (0.315Amp) Anti-Surge 20mm Fuses.

**Status LED indications:**  
 Flashing Green – Network healthy & All fuses ok.  
 Flashing Red – Immediate Network data error.  
 Flashing Red/Green – Recent Network Data Error. (In last 10 minutes)  
 Continuous Red – Fuse Failure. (Remove unit to investigate further)

**Installation:** Flush mount into 'double gang' electrical back-box. Surface mount using BB1.

**Size & Weights:** 160 x 115 x 20 mm, 70g

Intercall 600	*
Intercall 700	✓

## L758 Audio Display Unit.

An Audio Display Unit is required in every location where calls are to be shown, the alarm is to sound and the intercom facility is required. It features a two line LCD display with back-light, multi-level adjustable alarm, full two-way intercom facility to Audio call points and voice page facility to other displays and call points. It is capable of sounding a different tone for selected call points (doors, drug cupboards, telephone, etc) and only displaying specific call points (Zoning) if required. More information can be found from page 57. There is an open collector output which can be connected to trigger external equipment such as pagers, lamps and sounders. All displays are identical but can be configured on site to operate independently. The unit flush mounts into a standard double gang backbox or may be surface mounted using the Intercall **BB1**.

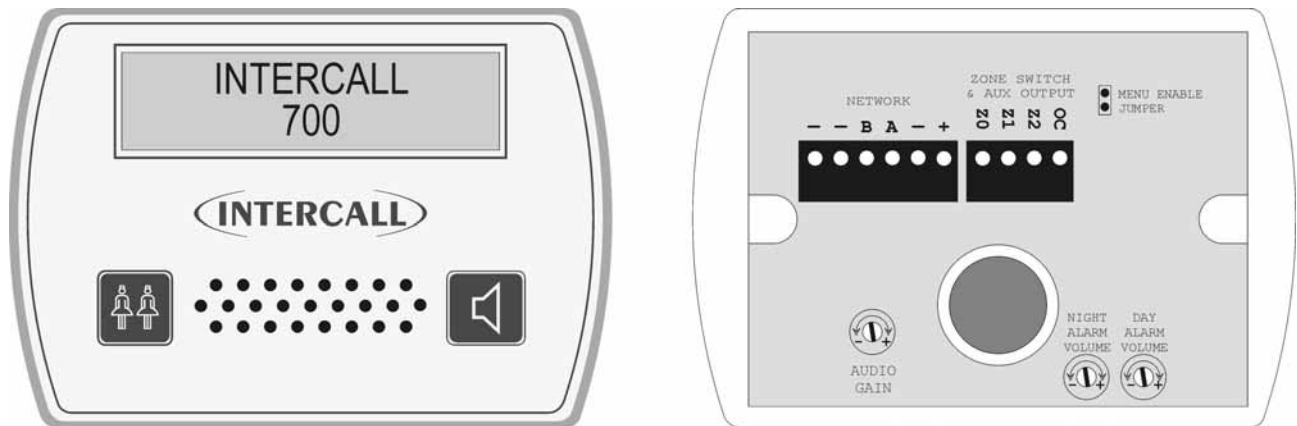

**Network Terminals:** Connect to the Intercall 700 (4 wire) Network. [+ , -,A,B] Additional terminals are provided for the Belden screen drain wire termination – Observe Polarity !

**Z0, Z1, Z2:** Connect to zone switch or wire link (*See ‘Zone Switch Connection’ Below*)

**OC Output Terminal:** Open collector output active continuously when the alarm is sounding.  
**Note: Rating 12vDC 100mA. Minimum [ON] resistance = 100 Ohms.**  
*The OC terminal may be used to trigger an external device directly, which will accept this type of input. Alternatively you may connect this terminal to a **RB1 Relay Board** which will provide normally open & normally closed ‘dry’ contacts.*

**Night Alarm Setting:** This controls the alarm volume when in ‘night’ mode.

**Day Alarm Setting:** This controls the alarm volume when in ‘day’ mode.  
*To change between the ‘day’ and ‘night’ mode you will need to connect a switch to the DAY/NIGHT terminals on the Master Power supply. (See page 29)*

**Audio gain control:** Controls the speech level output from the display unit. This does not effect the volume from the speaker in the unit.

**Menu Enable Jumper:** Remove to prevent access to the display menus and disable text download reception.

**Zone Switch:** This text is intended as a technical reference only and details of zoning are discussed on page 61. When a display is required to only sound for specific call points, we need to connect a switch or permanent wire link to the ‘Z’ terminals. The following connections force the display to use the address windows that are programmed on site:

Z1 Not Connected,	&	Z2 Not Connected	= Global (Sound for all calls)
Z1 Not Connected	&	Z2 Connected to Z0	= Use Address Window C
Z1 Connected to Z0	&	Z2 Not Connected	= Use Address Window B
Z1 Connected to Z0	&	Z2 Connected to Z0	= Use Address Window A

**Installation:** Flush mount - use standard ‘double size’ electrical backbox. Surface mount use BB1. (See page 21). Connects to system two core and optional zone switch and auxiliary devices.

**Sounder output:** Typical Maximum 92db@30cm.

**Size & Weights:** 80 x 140 x 40 mm, 200g

Intercall 600	✓
Intercall 700	✓

### L722 Infra Red Call Point.

The L722 Infra Red Call Point is similar to the L622 button reset unit, with the additional facilities of an infra red receiver & extra terminals for connection to slave call point(s). The unit may be used as part of an Intercall 600 or 700 system and the infra red receiver gives the system true portability with the use of the TIR and STC range of triggers and Pendants. More information on the TIR range of triggers may be found on page 51 Please refer to page 31 for more information on the L622 Call Point. Please refer to the information contained on page 22 for more information regarding installation and performance of the Infra Red receiver.

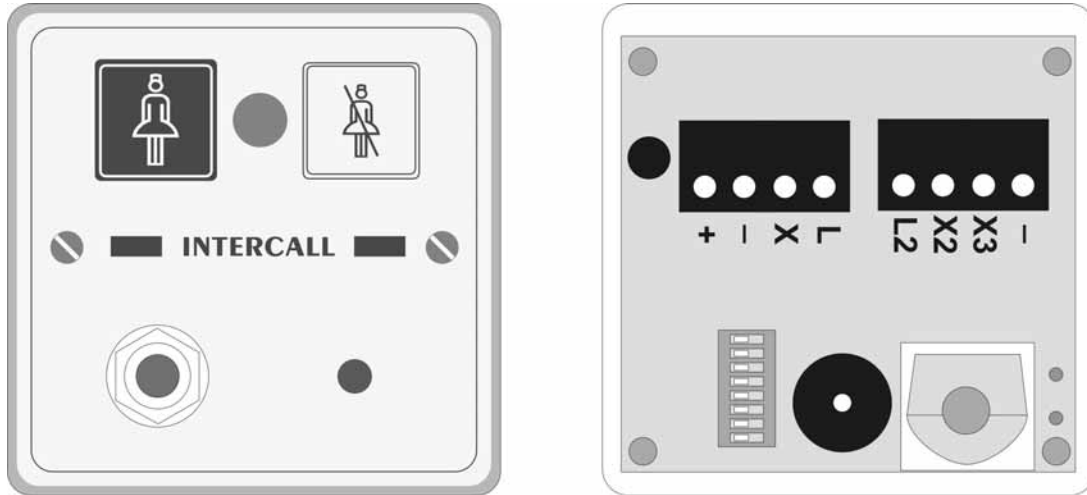

**Network Terminals:** Connect to the Intercall 600 or 700 (2 wire) Network. [+,-] OBSERVE POLARITY

**X Terminal:** Standard Call Input – automatically generates System User-id 3.

**X2 Terminal:** Emergency Call Input – automatically generates System User-id 4.

**X3 Terminal:** Reset/Present Input for use with Slave Reset Points.

**L Terminal:** Output signal to drive ceiling pull switches with built in re-assurance lights. *Max load 12v 10mA*

**L2 Terminal:** Output signal to drive Slave Reset Points Green LED. *Max load 12v 10mA*

**- Terminal:** Additional Network negative common terminal for auxiliary connections.

**Address Switches:** Set to unique setting between 1 and 215.

**System User-Id:** This feature allows the X1 and X2 input(s) to have a secondary description, for example ‘En-suit’ or ‘Ceiling Pull Cord’ when activated – *Only available when using L717.*

**Re-assurance LED:** Slow Red flashing – Standard Call  
Faster Red flashing – Priority Call  
Slow Red/Green flashing – Assistance Call  
Rapid Red flashing – Emergency/Crash Call  
Green flashing - Accepted Call – Staff on their way  
Constant Green – Nurse Present Mode

**IR Receiver:** Typically, the unit will cover a room 6m x 6m. **Important: Refer to notes on Page 22.**

**Pear lead Socket:** Industry standard socket that will accept any normally open switch.

**Installation:** Flush or surface mount in standard ‘single size’ electrical backbox.

**Size & Weights:** 80 x 80 x 40 mm, 70g

**Very Important: When flush mounting in metal backbox, ensure the backbox is bonded to mains electrical earth.**

Intercall 600	✓
Intercall 700	✓

## L634 Network Input / Output Module.

The L634 is used to interface an external device(s) to the Intercall system network. The unit features three input triggers; two non-latching and one remote reset and two outputs; Re-assurance LED & Open Collector which can be used to trigger external equipment for normal or emergency calls. Typical applications include telephone ringing detectors (with TA1), contacts from fire alarm or other control panels or input from remote contacts etc. It may also be used to link two independent Intercall systems together to allow signalling, such that an active alarm on one system triggers a call on the other system and visa versa.

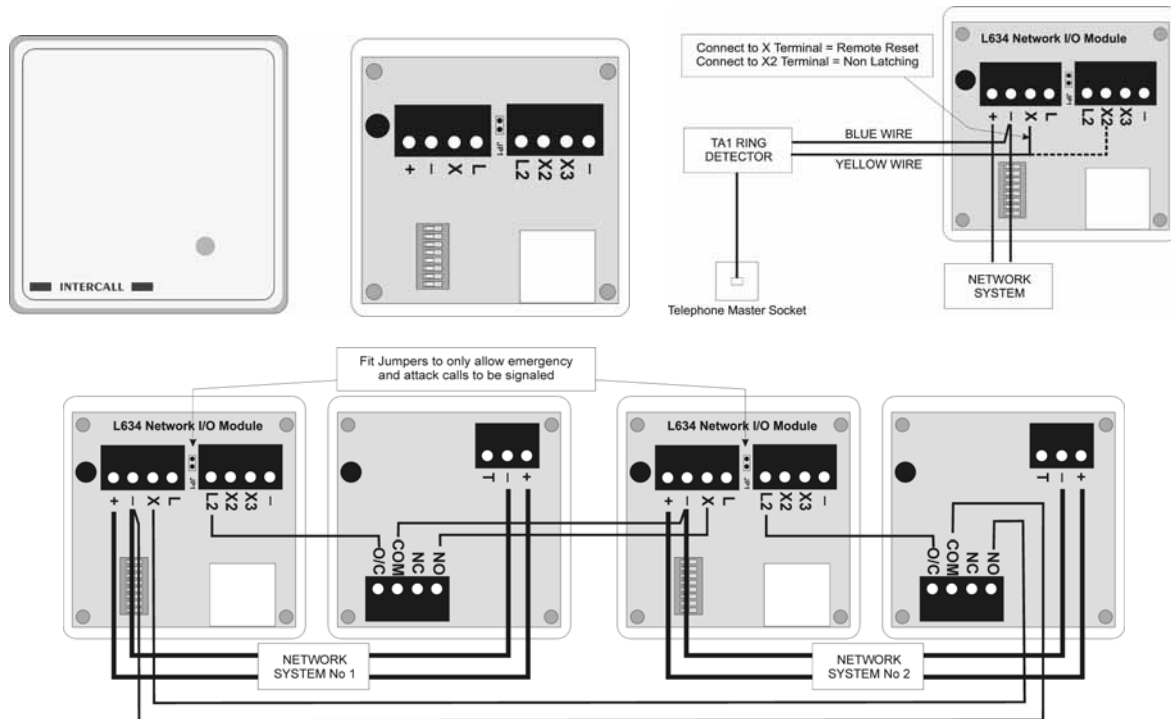

Shown above, the L634 signalling between two independent Intercall systems here we are using a pair of RB1 relay boards to keep the two systems isolated. Above right, the L634 in use with the TA1 Telephone Ring Detector to trigger a call on the system when the telephone is ringing.

**Network Terminals:** Connect to the Intercall 600 or 700 (2 wire) Network. [+ , -] OBSERVE POLARITY

**X Terminal:** Remote Reset Input. Connect to negative to trigger a Standard Call which is reset when the call is accepted at the display.

**X2 Terminal:** Non-Latching Call Input. Connect to negative to generate a Standard Call, when the connection to negative is broken, the call will automatically reset within 6 seconds. This call can be accepted at the display and will return after the accept timer has expired if the input trigger is still active.

**X3 Terminal:** Non-Latching Emergency Call Input. Connect to negative to generate an Emergency Call, when the connection to negative is broken, the call will automatically cancel within 6 seconds.

**L Terminal:** Re-assurance LED output +12V to confirm unit is triggered.

**L2 Terminal:** Open Collector Output, this output will only be active when there is a call on the Intercall Network, which does not originate from this device. When linking two independent systems together, you must also connect the Network (-) of both systems together.

**JP1 Jumper:** When fitted, the 'L2' output (described above) is only active for emergency and attack calls.

**Installation:** Flush or surface mount in standard 'single size' electrical back-box.

**Size & Weights:** 80 x 80 x 40 mm, 70g

Intercall 600	*
Intercall 700	✓

## L752 Audio Call Point.

An Audio Call Point is required for every individual call location on the system where the two way intercom facility is required. It features seven levels of call, hands free two way intercom, integral infra red receiver, programmable emergency button, audio page facility, audible call re-assurance, re-assurance LED and 'another call' sounder. The industry standard trigger socket will accept pear leads, pressure mats, portable radio triggers and a host of other triggering devices. The unit flush mounts into a standard double gang backbox or may be surface mounted using the Intercall BB1. Please refer to the information contained on page 22 for more information regarding installation and performance of the Infra Red receiver.

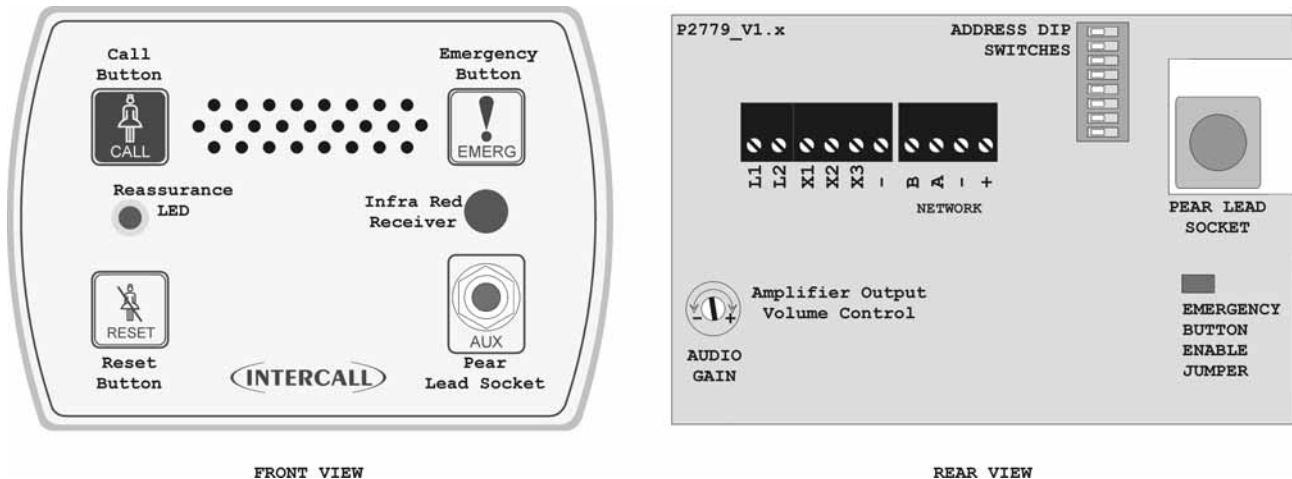

**Network Terminals:** Connect to the Intercall 700 four wire Network. [A,B,+, -] OBSERVE POLARITY

**X1 Terminal:** Standard Call Input – automatically generates System User ID 3.

**X2 Terminal:** Emergency Call Input – automatically generates System User ID 4.

**X3 Terminal:** Reset/Present Input for use with the Slave Points.

**L1 Terminal:** Output signal to drive ceiling pull switches with built in re-assurance lights. *Max load 12v 10mA*

**L2 Terminal:** Output signal to drive Slave Reset Point Green LED. *Max load 12v 10mA*

**- Terminal:** Additional Network negative common terminal for auxiliary connections.

**Emergency Jumper:** Remove to disable the Emergency button on the front panel.

**Address Switches:** Set to unique setting between 1 and 215.

**Re-assurance LED:**  
 Slow Red flashing – Standard Call  
 Faster Red flashing – Priority Call  
 Slow Red/Green flashing – Assistance Call  
 Rapid Red flashing – Emergency/Crash Call  
 Green flashing - Accepted Call / Intercom operating [Slow Flash]  
 Constant Green – Nurse Present Mode

**Audio gain control:** Controls the speech level output from the call point. This does not effect the volume from the speaker in the call point.

**IR Receiver:** Typically, the unit will cover a room 6m x 6m. **Important: Refer to notes on Page 22.**

**Installation:** Flush mount using standard 'double size' electrical backbox or surface mount using BB1

**Size & Weights:** 160 x 115 x 25 mm 135g

**Very Important: When flush mounting in metal backbox, ensure the backbox is bonded to mains electrical earth.**



Intercall 600	*
Intercall 700	✓

## L762 Audio Call/Display Unit.

The L762 Call/Display Unit provides all the combined features of the L752 Audio call point and L758 Audio LCD display. It features 7 levels of call, hands free two way intercom, integral infra red receiver, integral LCD display, audio page facility, audible call re-assurance, re-assurance LED and ‘another call’ sounder. The trigger socket will accept pear leads, pressure mats, portable radio triggers and a host of other triggering devices. The unit flush mounts into a standard double gang backbox or may be surface mounted using the Intercall **BB1**. The integral LCD display unit may be configured to operate in one of three modes: **Normal Display** where all calls are shown & sound regardless of the call point mode. **Silent Display** where calls are shown but only sound when the call point is in Nurse Present Mode, and **Nurse Present Only** where calls will only show and sound when the call point is in Nurse Present Mode. Emergency and Attack calls are shown in all call point modes. The X1 and X2 remote trigger inputs feature a secondary description facility where details for the remote device may be programmed. For example “En-Suit” or “Ceiling Pull Switch” may be allocated to these inputs. Please refer to the information contained on page 22 for more information regarding installation and performance of the Infra Red receiver.

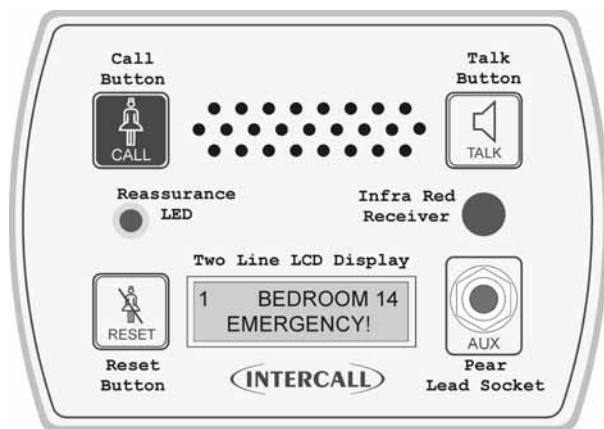

FRONT VIEW

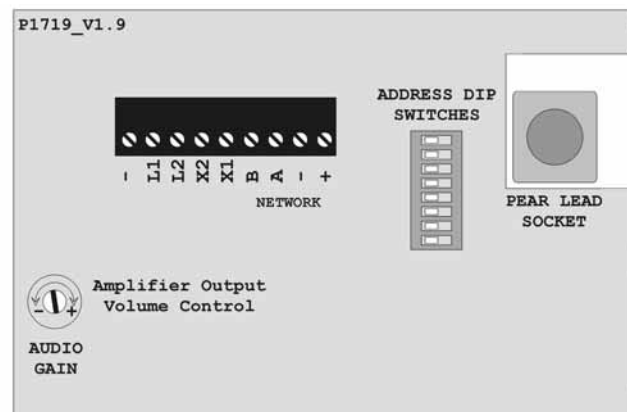

REAR VIEW

- Network Terminals:** Connect to the Intercall 700 4 wire Network. [A,B,+, -] **OBSERVE POLARITY**
- X1 Terminal:** Standard Call Input – automatically generates System User-id 3.
- X2 Terminal:** Emergency Call Input – automatically generates System User-id 4.
- L1 Terminal:** Output signal to drive ceiling pull switches with built in re-assurance lights. *Max load 12v 10mA*
- L2 Terminal:** Output signal for remote presence green LED units. *Max load 12v 10mA*
- Terminal:** Additional Network negative common terminal for auxiliary connections.
- Address Switches:** Set to unique setting between 1 and 215.
- Re-assurance LED:** Slow Red flashing – Standard Call  
Faster Red flashing – Priority Call  
Slow Red/Green flashing – Assistance Call  
Rapid Red flashing – Emergency/Crash Call  
Green flashing - Accepted Call – Staff on their way / Paging from Call Point  
Constant Green – Nurse Present Mode
- Audio gain control:** Controls the speech level output from the call point. This does not effect the volume from the speaker in the call point.
- IR Receiver:** Typically, the unit will cover a room 6m x 6m. **Important: Refer to notes on Page 22.**
- Integral LCD:** Two line, 32 character alphanumeric display.
- Installation:** Flush mount using standard ‘double size’ electrical backbox or surface mount using BB1
- Size & Weights:** 160 x 115 x 25 mm 135g

**Very Important: When flush mounting in metal backbox, ensure the backbox is bonded to mains electrical earth.**

## L768 Room Communicator Unit.

The L768 Room Communicator allows the intercom speech path to be initiated to a room without the room having called first, extending the capabilities of the Intercall 700 system into warden controlled establishments. The unit is very simple to use with the desired room selected using the rotary control on the front panel. In addition, general announcements (such as lunch times etc) can be made from the unit and these are sent into all bedrooms. The L768 must be used in conjunction with L758 displays to show and sound for calls from the rooms.

Announcements can be made to all L752 and L762 Audio call points providing the speech channel is not in use, including call points which are calling in emergency and attack. Individual Rooms can only be called when they are in the Reset or Nurse Presence condition. The call points give an attention double bleep to announce the page or intercom communication. Only L752 and L762 units with batch codes L04xxxx or later are compatible with the Room Communicator.

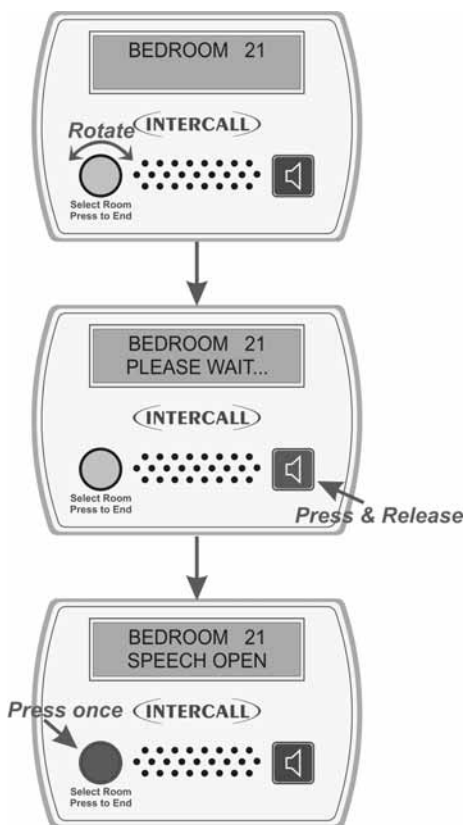
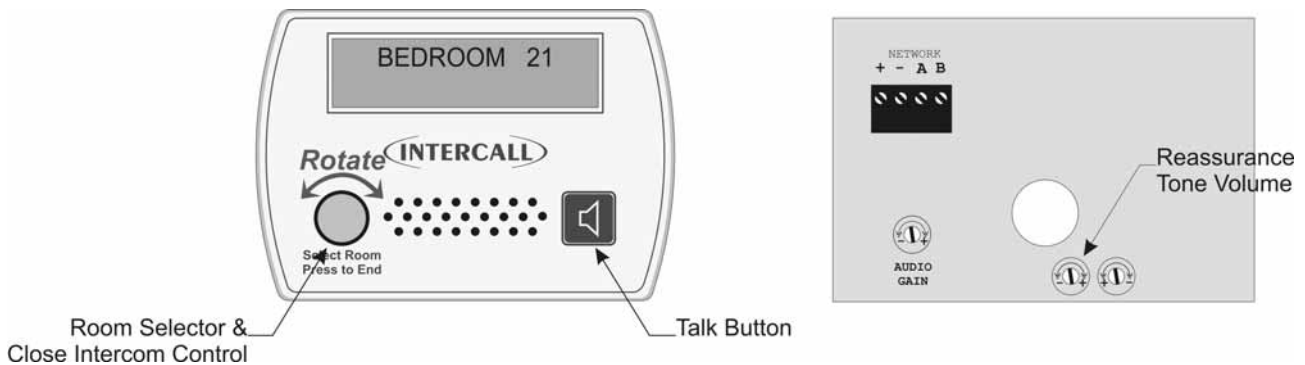

### To Call and Speak To A Room.

1. Turning the SELECT control clockwise or anticlockwise will scroll through the rooms on the system. Use this method until the desired room is showing on the top line. On the example to the left this is Bedroom 21.
2. With the desired room showing on the top line of the display, press and release the TALK button. The unit will show PLEASE WAIT on the lower line of the display while the selected room is contacted. Before the speech channel opens, a re-assurance double bleep will sound at the call point and at the Room Communicator.
3. Once the Re-assurance bleep has sounded, the speech channel is open from the room to the communicator. Press and hold the TALK button to speak to the room and release to hear the room.
4. When the conversation is complete and you wish to close the intercom, press and release the Select button. This will reset the unit and close the speech channel.
5. You may use the SELECT control to select another room as described in paragraph 1 above, alternatively, the unit will reset to the default text setting if the select control is not used for 10 seconds.

**Network Terminals:** Connect to the Intercall 700 four wire Network. [A,B,+, -] OBSERVE POLARITY

**Audio gain control:** Controls the speech level output from the communicator to the rooms. This does not effect the volume of the speech back from the rooms.

**Integral LCD:** Two line, 32 character alphanumeric display.

**Installation:** Flush mount using standard 'double size' electrical backbox or surface mount using BB 1

**Size & Weights:** 160 x 115 x 25 mm 135g

Intercall 600	✓
Intercall 700	✓

## CMS Lite Call Management Software.

The Intercall Call Management Software *Lite* is a simple way to manage all data from your Intercall 600 or Intercall 700 call system. All system activity is recorded and may be printed at a later stage for use in resident care assessment reports. The main screen, keeps a track of all system activity as it occurs, with all current calls highlighted, together with the location of staff. 'Pop up' warning screens can be configured to report standard calls, emergency calls or system faults. In addition, the Intercall Call Management software can be used to connect staff alphanumeric pagers. These are invaluable for keeping staff in touch with calling residents and specific members of staff can be alerted to specific events. For instance, the matron can be alerted to emergency calls only while system faults are routed through to maintenance. There is a 'Page Staff' facility, which allows a text message to be sent to any or all staff. The main screen can be configured for Intercall 600 where the date & time, call type and calling room are shown or Intercall 700 where the calling resident may also be shown. Intercall 700 mode is shown below.

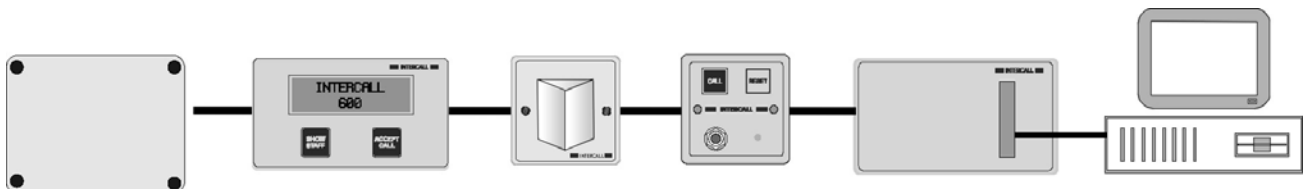
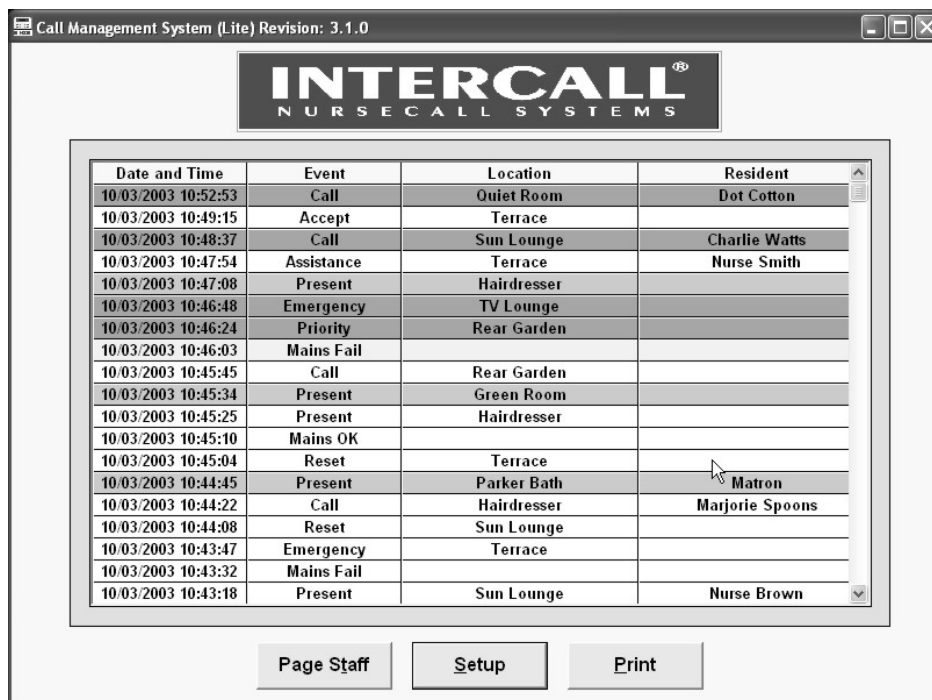

The CMS Lite software requires a L747 Universal Interface to connect to the Intercall system. The software is supplied with an interface cable fitted with both 9 and 25way connectors. This cable is connected to a serial communication port on the PC.

### The PC Requirements are listed below.

- PC compatible computer with Pentium P4-1000MHz (or equivalent or better)
- CD Rom drive (The software is supplied on CD Rom only)
- Microsoft® Windows 2000/Windows XP (Windows XP Professional recommended)
- 128Mb Ram
- Available 9pin RS232 serial communication port (Only Com1 and Com2 supported in software)
- Minimum 1Gb free space on hard disk

If the CMS lite software is to be used with the alphanumeric pagers, **L747YL** three way serial lead is required which connects to the PC, L747 and Scope pager transmitter.

### Password Access and Installation Details.

A password is required to enter the 'Setup' screen or exit the software. Installation details and factory default passwords are contained within the **readme.txt** file supplied on the CD Rom.

Intercall 600	✓
Intercall 700	✓

### TIR4 Infra Red Pendant Trigger.

The infra red trigger is worn by residents and allows access to the call system at all times. It will trigger any Intercall 700 series call point within range and can be configured to generate different levels of call. Each trigger is assigned a unique number which may be programmed into the system to identify the calling resident by name. All Intercall 700 series call points are fitted with infra red receivers as standard and one call point will typically cover a room area of **20sq metres**. For information on the positioning of infra red call points please refer to page.

The battery life in the trigger depends on frequency of use and in a typical TIR4 installation expected life is between 6 and 12 months. The battery is a 12volt battery type 23A Alkaline which is available from many retail stores.

#### Detail of the TIR4 Mk1 and Mk2 Trigger:

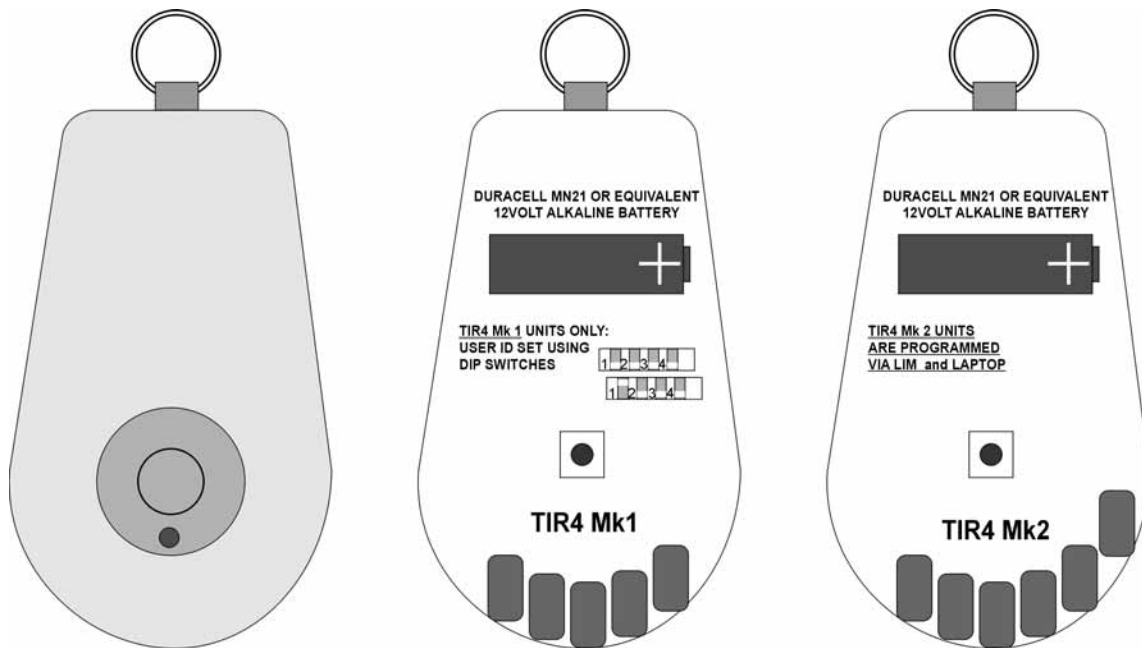

Intercall 600	✓
Intercall 700	✓

## LIMKIT System Configuration Kit.

The LIMKIT contains all required components to configure the system including interface, leads and software. The USB Programming Module is used to program the software configurable devices such as the ST Triggers & **TIR4** Pendants and L747 together with the Room Text and User ID text within the power supply units. The unit is supplied with connection leads which are required to program different devices.

- Power Supply Connection Lead for programming L617, L717 and L7717.
- Trigger Programming Lead for STC2,3,5,6 and TIR MK2 & 3.
- L747 Programming Lead.

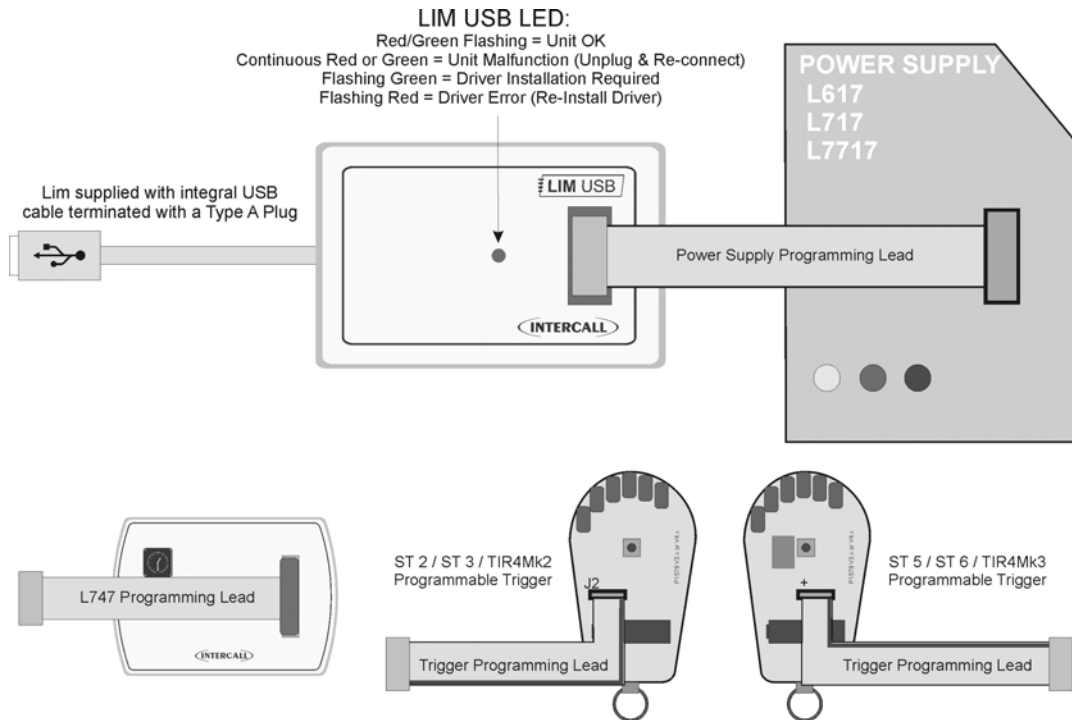

## LIMPROG USB Configuration software.

The LIMPROG Configuration Software is used in conjunction with the LIM Programming Module to program the text within the system. See page 57 for more information. The software is supplied on CD ROM, to install the software, run the *setup.exe* installation program which has on-screen help & instructions. All the text used by the system is stored in the power supply and can be downloaded to the system by either the software or by using the *download* button on the power supply. (See page 29) Once downloaded, the information is also stored in the displays, printer interface and alphanumeric pager interface.

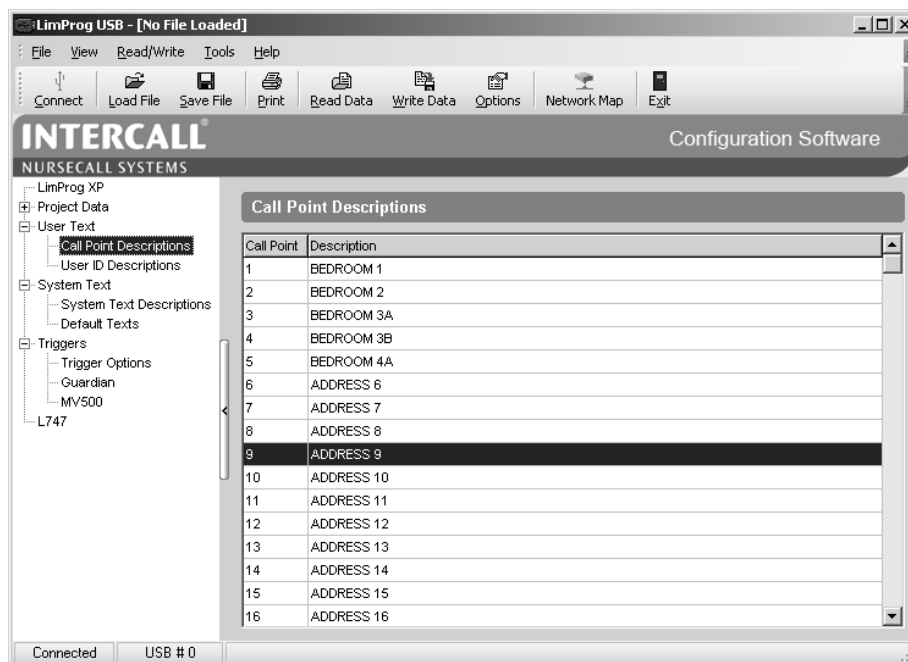

Intercall 600	✓
Intercall 700	✓

### SCP Slave Call Point.

Slave call points are used to cover several beds or areas in one room or ward where each individual point does not require a separate identity on the call system. Units must be wired back to a standard call point to provide the reset and to generate the call address. Slave Call Points can only generate 'standard patient call' from either the call button or pear lead socket.

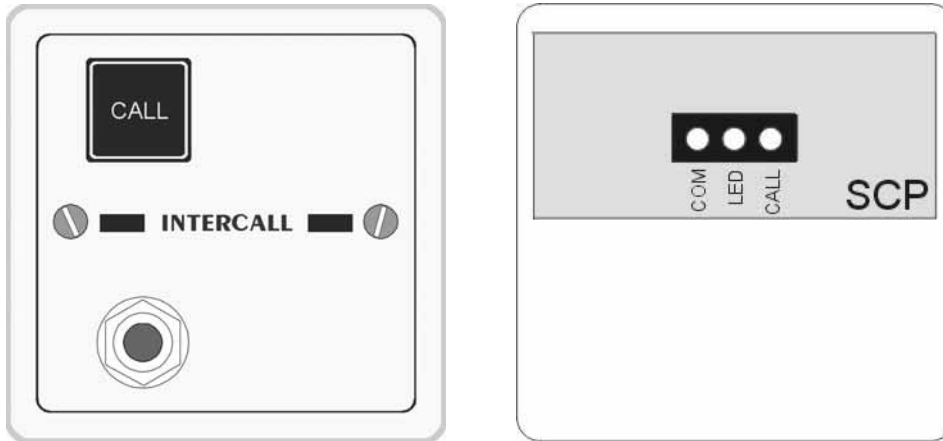

Above: Front panel and pcb detail of the SCP Slave Call Point

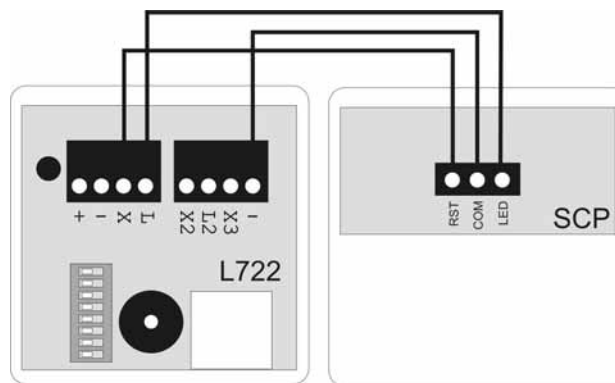

SCP Connects to call point 'X' and '-' terminals (L722 call point shown above)

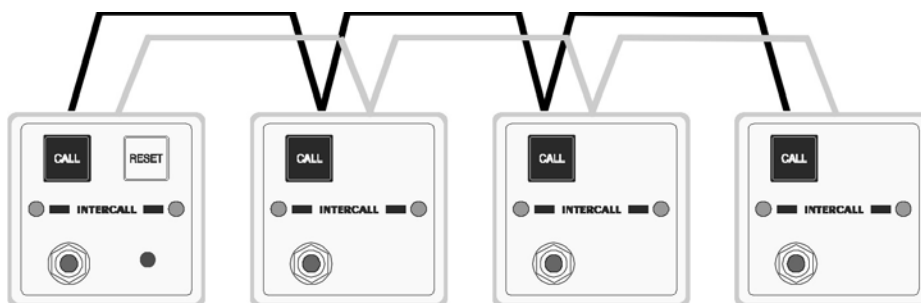

Several Slave Call Points may be used to trigger a single call point

**Pear lead Socket:**

Industry standard socket that will accept any normally open switch. *This socket can accept input from pear leads, pressure mats, radio triggers etc.*

**Installation:**

Flush or surface mount in standard 'single size' electrical backbox.

**Size & Weights:**

80 x 80 x 40 mm, 60g

Intercall 600	✓
Intercall 700	✓

### SRP Slave Reset / Present Point.

Slave Reset / Present Points are normally located by the door of a bedroom to enable staff to reset the call point and to register as staff present away from the patient call point. The unit is used in conjunction with the L732 Call Point, which has additional terminals for this purpose.

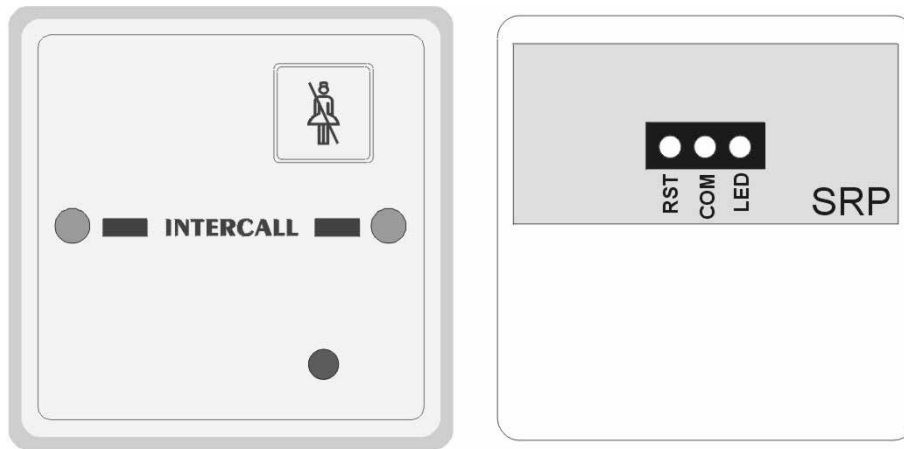

Above: Front panel and pcb detail of the SRP Slave Reset/Present Point

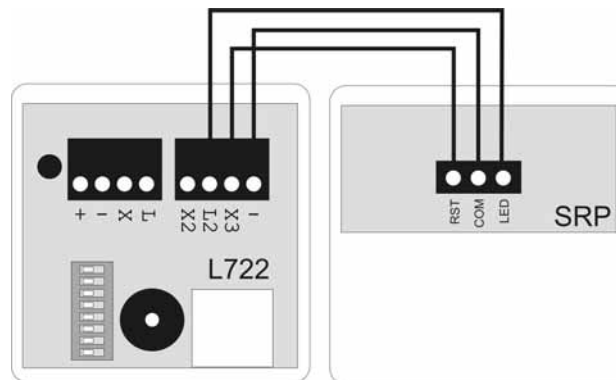

Above: SRP Connects to L722 (Mk2) Call point using X2 and L2 terminals

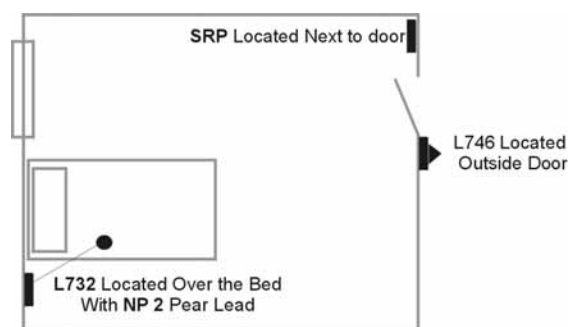

Above: Typical Room Layout showing L732 Call Point, SRP Remote/Preset Unit and L746 Overdoor Light.

- Reset Button:** Performs same functions as reset button on L732 but in remote location.
- LED:** Green Led operates with green re-assurance LED in L732 Call Point
- Installation:** Flush or surface mount in standard 'single size' electrical backbox.
- Size & Weights:** 80 x 80 x 40 mm, 60g

Intercall 600	✓
Intercall 700	✓

### CS1 Ceiling Pull Switch.

Ceiling Pull Switches are used in bathrooms, fitted to the ceiling over the toilet and bath to allow a call to be generated from these areas. They are fitted with 3 metre length of orange cord terminated with an easy to operate 'G' style pull and twin re-assurance indicators.

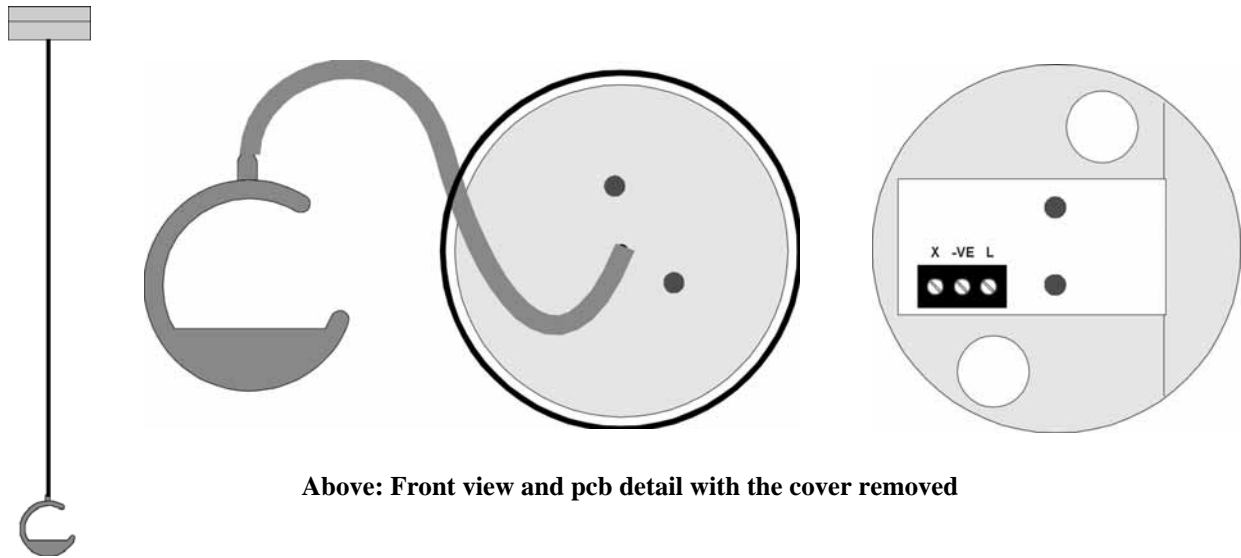

Above: Front view and pcb detail with the cover removed

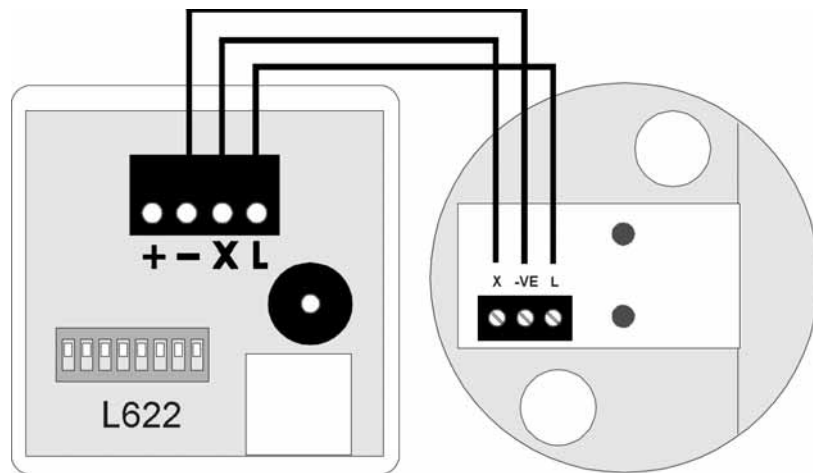

CS1 Connects to call point 'X' '-ve' and 'L' terminals (L622 call point shown above)

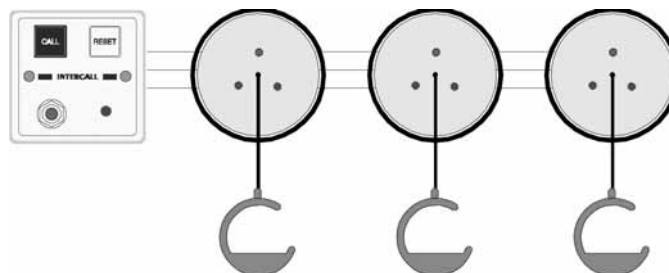

**Very Important: A MAXIMUM OF 3 CS1 UNITS MAY BE CONNECTED TO ONE CALL POINT**

- Cord:** 3 metres orange with easy to operate 'G' pull in orange.
- Installation:** Surface mount in self contained enclosure.
- Size & Weights:** Diameter 80mm x depth 30mm weight 50g



Intercall 600	✓
Intercall 700	✓

### PIR1 PIR Detector used to monitor beds.

The PIR1 unit is a network compatible unit which can trigger a call point when a resident is out of bed. The unit is often used with an isolating switch located outside the room to remotely enable and disable the device. The unit is also available with a delay function to prevent unnecessary calls and for dementia care systems. please contact the technical department for more information. The unit can be used as a simple PIR for security and access control purposes or with the use of a mask (*shown fitted below*) to monitor a bed. The location of the unit is important and this is detailed below.

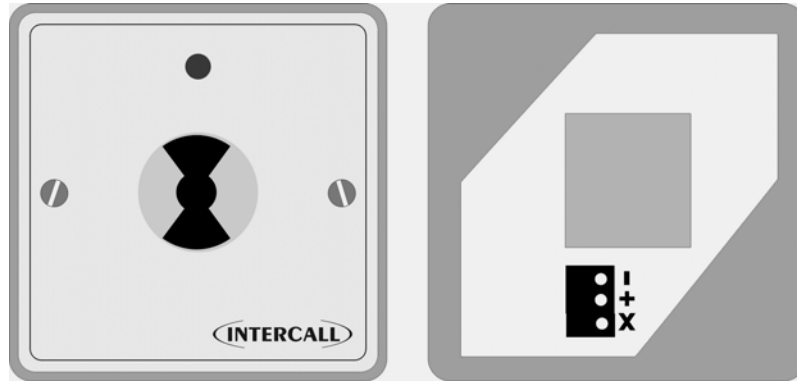

**Above: Front view and pcb connection detail**

MASKS ARE FREE ON REQUEST BUT MUST BE ORDERED SEPARATELY

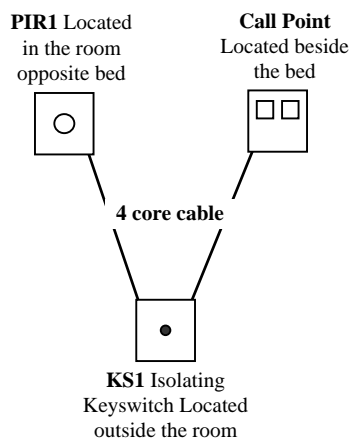

Typical installation example for bed monitoring applications

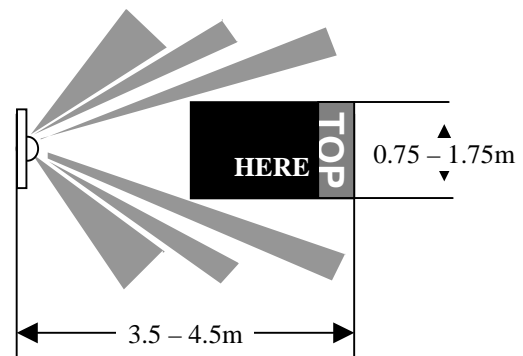

View from above. *Location of the PIR1 is very important for effective operation.*

### PIR1 Connects to call point 'X' and network '+' and '-'

**Very Important: LOCATION OF THE PIR1 FOR BED MONITORING**

- Mount the PIR 1 at a height of 2m from floor level.
  - The bed must be minimum 0.75m wide and no greater than 1.75m.
  - The pillow end of the bed must be furthest away from the PIR1.
  - The headboard must be between 3.5 and 4.5 metres from the PIR1.
- ENSURE UNITS ARE ISOLATED AT POWER UP**

**Connections:**

PIR1 Connects to call point 'X' and network '+' and '-'

**Warm up period:**

As the PIR1 will continually call for 10 minutes after power up – ensure the units are isolated at time of system power up.

**Installation:**

Surface mount in standard single gang backbox.

**Size & Weights:**

80mm x 80mm x depth 25mm weight 50g

## Configuration Guide.

These pages are intended to give the reader an overview of the possibilities using Intercall 600 and Intercall 700 systems for specific configurations. Detailed information on the individual components can be found from page 29.

Below we list the parameters that can be configured with the Intercall 600 & 700

- Changing the call point text messages.
- Changing the text which is shown when no calls are active.
- Display Alarm Tone volume settings.
- Reduced Alarm Tone from displays at night time.
- Changing the time before a standard call becomes an emergency and/or disabling this function completely.
- Changing the time before a standard call becomes a priority call and/or disabling this function completely.\*
- Changing the time before an accepted call returns to the calling state (Mute Timer)
- Enabling and disabling the nurse present auto-expiry timer. (Mk2 Products only)
- Disabling the 'Call Follower' sounder on the call points.
- Disabling the nurse present feature on the call points.
- Making specific call points generate a different alarm sound from the displays.
- Disabling the Accept Call function on the displays
- Enabling LCD display units to show faulty or missing network devices.\*
- Enabling LCD display units to show resident name as well as call location.\*
- Making the LCD displays show only specific call points (Zoning).
- Supervisors Display Showing all calls but only sounding for crash calls.

*\*Intercall 700 only*

### **Programming the text messages**

The first thing we will need to do is to set the switches on the call points so we can give each unit a text identity. (This is what will be displayed when the call point is active e.g. 'BEDROOM 14') .Before we can begin we need to ask the following questions:

- Will the system be zoned ? (Operated in areas e.g. wings or floors)
- Will we need more than one call point with the same text (E.g. rooms with more than one bed).
- Will we need special text that is not in the factory default. (E.g. names or wards etc)

If the answer to all of the above is **no** then we can continue with the factory configuration described below. If the answer to any of the above is yes, please read the paragraph 'Custom configuration'.

### **Factory Text Configuration.**

The factory text is programmed into the power supply and displays when despatched from the factory and a listing is provided within this manual. Simply set the switches on the call point to the desired setting. **NOTE: All call points must have a unique switch setting.**

### **Custom Text Configuration**

If a system is to be zoned or where repeated or special text is required, the power supply will need to be programmed. The text can be customised by one of the following:

- i. Configuration Kit part no: LIMKIT. (Runs on any PC compatible computer)
- ii. Your Supplier or the factory – A nominal charge is made for this service

### **Zoning Text**

If a system is to be zoned we must disregard the text and concentrate on the call point address as the text can be programmed at a later date. See page 61 for more information and examples of zoning.

### **Repeated text.**

If a system requires more than one call point to have the same text identity (e.g. two beds in one room) we can set the call point to an address with a text identity we do not require and re-program the text.

### **Special text.**

If a system requires special text we can either address the first call point 01, the second 02 etc and completely re-program the entire text or we can use part of the factory text and re-program only certain addresses.

### **Changing the text shown when no call is active.**

Using the LIMPROG Programming software (Supplied in the LIMKIT), you may alter the default text. This allows your company name and a call out telephone number to be shown if you wish. You have two lines of 16 characters which may be used. The factory default is 'Intercall 600' or 'Intercall 700' depending on the system.

### **LCD Display Alarm Volume Levels.**

Every LCD display is fitted with a 'Day' and 'Night' alarm volume setting. The volume of each LCD display may be set up independently depending on the local conditions and background noise. See page 35 for more detailed information.

### **Reducing the alarm volume at night.**

With the addition of a 'day/night' switch connected to the Power Supply, the alarm volume from the LCD displays may be reduced at night time. When the switch is thrown, the LCD Display units automatically use their 'night' alarm settings which may be configured individually to suit the local conditions. See pages 29 and 35 for more detailed information.

### **System Features Configuration.**

The System configuration is controlled by the master power supply (L617/L717) and is adjusted by means of a bank of DIL switches detailed on page 74. They control the following features:

- Changing the time before a standard call becomes an emergency and/or disabling this function completely.
- Changing the time before an accepted call returns to the calling state (Mute Timer)
- Disabling the 'Call Follower' sounder on the call points.
- Disabling the reset button present/reset toggle on the call points.
- Enabling and disabling the nurse present auto-expiry timer. (Selected products only)
- Enabling LCD display units to show faulty or missing network devices.\*
- Enabling LCD display units to show resident name as well as call location.\*
- Changing the time before a standard call becomes a priority call and/or disabling this function completely.\*

\* *Intercall 700 systems only using L717 Power Supply*

Page 74 details all possible switch settings and the user guide from page 9 onwards, describes the features operation.

### **Display Features Configuration.**

The Display features configuration is controlled by menu driven settings in all LCD Display units. Access to the display menus is obtained by first pressing and holding down the 'Show Staff' button. While holding down the 'Show Staff' button, press and hold the 'Accept Call' button for 10 seconds. The following features are changed from within the display menus:

- Making specific call points generate a different alarm sound from the displays. (2<sup>nd</sup> Tone)
- Disabling the Accept Call function on the displays. (Accept Button enable)
- Making the LCD displays show only specific call points (Zone A,B,C).
- Supervisors Display Showing all calls but only sounding for crash calls.

\* *Intercall 700 systems only using L717 Power Supply*

Displays can be configured to show only certain call points (Zoning) and/or certain call types ('Supervisor' displays where staff are to be alerted only for emergency calls) The Accept Calls feature can be disabled for corridor displays or on installations where this feature is not required. Displays can be set up to sound a different alarm tone for certain call points (Doors or drug cupboards etc) 'Master Displays' can be configured to show all activity on a zoned system but only sound for local calls. For more information on display configuration with zoning see page 61. More detailed information on the display configuration can be found in page 59 'display menus'.

We have chosen to show the zoning configuration by giving typical examples of zoning requirements that we have encountered using the Intercall system. Intercall 600 and 700 displays feature the zoning menu described in page 61 and the Intercall 700 zoning capabilities will be extended in the future.

The L748 LED display unit features additional menus which are described on page 61

## L628 Display Menu Settings Only

Access to the display menus is obtained by first pressing and holding down the 'Show Staff' button. While holding down the 'Show Staff' button, press & hold the 'Accept Call' button down for 10 seconds\*. To change the displayed option, press the 'Show Staff' button. To move to the next item, press the 'Accept Call' button. When the display is showing the last menu item one more press of the 'Accept Call' will return the unit to normal operating mode.

\* This unit is fitted with a jumper which must be fitted to allow access to the menu.

<u>Menu</u>	<u>Settings</u>	<u>Description</u>
<b>DISPLAY ADDRESS: 00</b>	00 to 07 or 15	Sets the <b>Display Address</b> of the unit. When display address 1 or above is selected, and the unit is not in master mode, the menu will jump to 2ND TONE LO ADD.
<b>ZONE A LOW ADD: 001</b>	001 to 215	Select the Lowest call point address for zone switch position A. <i>This function is available only when the display is in master mode or set to Display Address 00.</i>
<b>ZONE A HI ADD: 215</b>	001 to 215	Select the Highest call point address for zone switch position A. <i>This function is available only when the display is in master mode or set to Display Address 00.</i>
<b>ZONE B LOW ADD: 001</b>	001 to 215	Select the Lowest call point address for zone switch position B. <i>This function is available only when the display is in master mode or set to Display Address 00.</i>
<b>ZONE B HI ADD: 215</b>	001 to 215	Select the Highest call point address for zone switch position B. <i>This function is available only when the display is in master mode or set to Display Address 00.</i>
<b>ZONE C LOW ADD: 001</b>	001 to 215	Select the Lowest call point address for zone switch position C. <i>This function is available only when the display is in master mode or set to Display Address 00.</i>
<b>ZONE C HI ADD: 215</b>	001 to 215	Select the Highest call point address for zone switch position C. <i>This function is available only when the display is in master mode or set to Display Address 00.</i>
<b>2ND TONE LOW ADD: OFF</b>	OFF / 001 to 215	Select the Lowest call point address for the Second Tone alarm setting. <i>This range operates in addition to the zone windows above.</i>
<b>2ND TONE LOW ADD: OFF</b>	OFF / 001 to 215	Select the Highest call point address for the Second Tone alarm setting. <i>This range operates in addition to the zone windows above.</i>
<b>ACCEPT BUTTON: ENABLED</b>	ENABLED DISABLED	When enabled, allows the calls to be accepted at this display using the Accept button. When disabled, this function does not operate on this display only.
<b>SHOW ALL CALLS: ENABLED</b>	ENABLED DISABLED	When enabled, this display will show all calls on the system but will only sound the audible alarm for calls in the current zone.
<b>SOUND FOR: ALL CALLS</b>	ALL CALLS EMERGENCY CALLS ONLY	Select "Emergency Only" to allow Emergency and Attack calls only to generate the audible alarm from this display. All other call types will be shown but the audible alarm will not operate on this display.
<b>ACCEPT ATTACK: ENABLED</b>	ENABLED DISABLED	When enabled, allows ATTACK calls to be accepted at this display using the Accept button. When disabled, this feature will be removed from this display only.
<b>PRIORITY CALLS: ALL ZONES</b>	OWN ZONE ONLY ALL ZONES	Select "All Zones" to allow this display to show and sound for Priority calls in all zones on the system. "Own Zone Only" will not show or sound for Priority Calls from other zones.
<b>EMERGENCY CALLS: ALL ZONES</b>	OWN ZONE ONLY ALL ZONES	Select "All Zones" to allow this display to show and sound for Emergency and Attack calls in all zones on the system. "Own Zone Only" will not show or sound for Emergencies or Attack calls from other zones.

### L758 Standard Display Menu Settings (not L628, L748 or L762)

Access to the display menus is obtained by first pressing and holding down the 'Show Staff' button. While holding down the 'Show Staff' button, press and hold the 'Accept Call' button. After holding both buttons down for 10 seconds, you should gain access to the menus. To change the displayed option, press the 'Show Staff' button. To move to the next item, press the 'Accept Call' button. When the display is showing the last menu item (EMERGENCY CALLS), one more press of the 'Accept Call' will return the unit to normal operating mode. *Please note while in the menu mode, the unit will not respond to system activity. You will need to fit the menu enable jumper to gain access to the L628 Display Menus.*

<u>Menu</u>	<u>Settings</u>	<u>Description</u>
<b>DISPLAY ADDRESS: 00</b>	00 to 07*	Sets the <b>Display Address</b> of the unit. When display address 1 or above is selected, and the unit is not in master mode, the menu will jump to 2ND TONE LO ADD. <i>*Earlier software revision has a range of 00 to 15, do not use above 07.</i>
<b>ZONE A LOW ADD: 001</b>	001 to 215	Select the Lowest call point address for zone switch position A. <i>This function is available only when the display is in master mode or set to Display Address 00.</i>
<b>ZONE A HI ADD: 215</b>	001 to 215	Select the Highest call point address for zone switch position A. <i>This function is available only when the display is in master mode or set to Display Address 00.</i>
<b>ZONE B LOW ADD: 001</b>	001 to 215	Select the Lowest call point address for zone switch position B. <i>This function is available only when the display is in master mode or set to Display Address 00.</i>
<b>ZONE B HI ADD: 215</b>	001 to 215	Select the Highest call point address for zone switch position B. <i>This function is available only when the display is in master mode or set to Display Address 00.</i>
<b>ZONE C LOW ADD: 001</b>	001 to 215	Select the Lowest call point address for zone switch position C. <i>This function is available only when the display is in master mode or set to Display Address 00.</i>
<b>ZONE C HI ADD: 215</b>	001 to 215	Select the Highest call point address for zone switch position C. <i>This function is available only when the display is in master mode or set to Display Address 00.</i>
<b>2ND TONE LOW ADD: OFF</b>	OFF / 001 to 215	Select the Lowest call point address for the Second Tone alarm setting. <i>This range operates in addition to the zone windows above.</i>
<b>2ND TONE HI ADD: OFF</b>	OFF / 001 to 215	Select the Highest call point address for the Second Tone alarm setting. <i>This range operates in addition to the zone windows above.</i>
<b>ACCEPT BUTTON: ENABLED</b>	ENABLED DISABLED	When enabled, allows the calls to be accepted at this display using the Accept button. When disabled, this function does not operate on this display only.
<b>SHOW ALL CALLS: ENABLED</b>	ENABLED DISABLED	When enabled, this display will show all calls on the system but will only sound the audible alarm for calls in the current zone.
<b>SOUND FOR: ALL CALLS</b>	ALL CALLS EMERGENCY CALLS ONLY	Select "Emergency Only" to allow Emergency and Attack calls only to generate the audible alarm from this display. All other call types will be shown but the audible alarm will not operate on this display.
<b>EMERGENCY CALLS: ALL ZONES</b>	OWN ZONE ONLY ALL ZONES	Select "All Zones" to allow this display to show and sound for Emergency and Attack calls in all zones on the system. "Own Zone Only" will not show or sound for Emergencies or Attack calls on other zones.

## L762 Call/Display Menu Settings

The L762 Call/Display has a unique menu structure, based on the standard display menu, but with additional functions relating specifically to this unit. Access to the menus is obtained by; pressing and holding down the 'Reset' button. While holding down the 'Reset' button, press and hold the 'Talk' button. After holding both buttons down for 10 seconds, you should gain access to the menus. To change the displayed option, press the 'Reset' button. To move to the next item, press the 'Talk' button. When the display is showing the last menu item (DEFAULT TEXT), one more press of the 'Accept Call' will return the unit to normal operating mode. *Please note while in the menu mode, the unit will not respond to system activity.* This unit can only be configured as a slave display and must receive the zoning information from a master display set to the same display address.

<u>Menu</u>	<u>Settings</u>	<u>Description</u>
<b>DISPLAY ADD: 00</b>	00 to 07	Sets the <b>Display Address</b> of the unit. When display address 1 or above is selected, the menu will jump to 2ND TONE LO ADD. <b>This Unit can only be configured as a slave display and must receive the zoning information from a master display set to the same display address.</b>
<b>ZONE A LO: 001</b>	001 to 215	Select the Lowest call point address for zone switch position A. <i>This function is available only when the display is set to Display Address 00.</i>
<b>ZONE A HI: 215</b>	001 to 215	Select the Highest call point address for zone switch position A. <i>This function is available only when the display is set to Display Address 00.</i>
<b>ZONE B LO: 001</b>	001 to 215	Select the Lowest call point address for zone switch position B. <i>This function is available only when the display is set to Display Address 00.</i>
<b>ZONE B HI: 215</b>	001 to 215	Select the Highest call point address for zone switch position B. <i>This function is available only when the display is set to Display Address 00.</i>
<b>ZONE C LO: 001</b>	001 to 215	Select the Lowest call point address for zone switch position C. <i>This function is available only when the display is set to Display Address 00.</i>
<b>ZONE C HI: 215</b>	001 to 215	Select the Highest call point address for zone switch position C. <i>This function is available only when the display is set to Display Address 00.</i>
<b>2ND TONE LO: OFF</b>	OFF / 001 to 215	Select the Lowest call point address for the Second Tone alarm setting. <i>This range operates in addition to the zone windows above.</i>
<b>2ND TONE HI: OFF</b>	OFF / 001 to 215	Select the Highest call point address for the Second Tone alarm setting. <i>This range operates in addition to the zone windows above.</i>
<b>DISPLAY MODE:</b>	NURSE PRES ONLY NORMAL DISPLAY SILENT DISPLAY	Select when the LCD display is enabled. NURSE PRES ONLY will enable the display only when the unit is in Nurse Present Mode. NORMAL DISPLAY will enable the display & audible alarm continuously. SILENT DISPLAY will enable the LCD continuously, however the audible alarm will only operate when the call point is in Nurse Present mode.
<b>SHOW ALL CALLS:</b>	ALL ZONES OWN ZONE ONLY	Select "All" to allow this display to show and sound for Emergency and Attack calls in all zones on the system. "Own Zone Only" will not show or sound for Emergencies or Attack calls on other zones.
<b>SOUND FOR:</b>	ALL CALLS EMERGENCY ONLY	Select "All" to allow this display to respond for all call levels, Select "Emergency Only" to ignore all calls apart from Emergency and Attack Calls.
<b>EMERGENCY CALLS:</b>	ALL ZONES OWN ZONE ONLY	Select "ON" to show the top line of the default text in quiescent mode eg "INTERCALL". Select "OFF" to clear the display in quiescent mode. <i>A single red led will continue to flash indicating unit operational.</i>

## L748 LED Display Menu Settings

The L748 Call/Display has a unique menu structure, based on the standard display menu, but with additional functions relating specifically to this unit. Access to the display menus is obtained by using the two hidden buttons located on the front panel. Please refer to page 36 for more information. Access to the menus is obtained by; pressing and holding down the 'Show Staff' button. While holding down the 'Show Staff' button, press and hold the 'Accept Call' button. After holding both buttons down for 10 seconds, you should gain access to the menus. To change the displayed option, press the 'Show Staff' button. To move to the next item, press the 'Accept Call' button. When the display is showing the last menu item (DEFAULT TEXT), one more press of the 'Accept Call' will return the unit to normal operating mode. *Please note while in the menu mode, the unit will not respond to system activity.* This unit can only be configured as a slave display and must receive the zoning information from a master display set to the same display address.

<u>Menu</u>	<u>Settings</u>	<u>Description</u>
<b>DISPLAY ADD: 00</b>	00 to 07	Sets the <b>Display Address</b> of the unit. When display address 1 or above is selected, the menu will jump to 2ND TONE LO ADD. <b>This Unit can only be configured as a slave display and must receive the zoning information from a master display set to the same display address.</b>
<b>ZONE A LO: 001</b>	001 to 215	Select the Lowest call point address for zone switch position A. <i>This function is available only when the display is set to Display Address 00.</i>
<b>ZONE A HI: 215</b>	001 to 215	Select the Highest call point address for zone switch position A. <i>This function is available only when the display is set to Display Address 00.</i>
<b>ZONE B LO: 001</b>	001 to 215	Select the Lowest call point address for zone switch position B. <i>This function is available only when the display is set to Display Address 00.</i>
<b>ZONE B HI: 215</b>	001 to 215	Select the Highest call point address for zone switch position B. <i>This function is available only when the display is set to Display Address 00.</i>
<b>ZONE C LO: 001</b>	001 to 215	Select the Lowest call point address for zone switch position C. <i>This function is available only when the display is set to Display Address 00.</i>
<b>ZONE C HI: 215</b>	001 to 215	Select the Highest call point address for zone switch position C. <i>This function is available only when the display is set to Display Address 00.</i>
<b>2ND TONE LO: OFF</b>	OFF / 001 to 215	Select the Lowest call point address for the Second Tone alarm setting. <i>This range operates in addition to the zone windows above.</i>
<b>2ND TONE HI: OFF</b>	OFF / 001 to 215	Select the Highest call point address for the Second Tone alarm setting. <i>This range operates in addition to the zone windows above.</i>
<b>SHOW CALLS: ON</b>	ON / OFF	When ON, this display will show all calls on the system but will only sound the audible alarm for calls in the current zone.
<b>EMERG CALLS: ALL</b>	ALL / OWN	Select "All" to allow this display to show and sound for Emergency and Attack calls in all zones on the system. "Own Zone Only" will not show or sound for Emergencies or Attack calls on other zones.
<b>CALL LEVEL: ALL</b>	ALL / ONE / TWO	Select "All" to allow this display to respond for all call levels, Select "One" to ignore Emergency and Attack Calls. Select "Two" to ignore all calls other than Emergency and Attack calls. <i>This function over-rides all other settings on this display.</i>
<b>DEFAULT TEXT: OFF</b>	ON / OFF	Select "ON" to show the top line of the default text in quiescent mode eg "INTERCALL". Select "OFF" to clear the display in quiescent mode. <i>A single red led will continue to flash indicating unit operational.</i>

## L672 Dementia Controller Menu Settings

The L672 Dementia Controller has a powerful menu structure which enables the units to be configured on site and altered at anytime in the future without the need for programming tools.

<u>Menu</u>	<u>Settings</u>	<u>Description</u>
<b>SELECT PROFILE: 00</b>	00 to 15	Fifteen preset profiles which can be selected to suit the individual occupants normal behaviour patterns. <i>Please refer to the profile table for more information on specific timings for each profile</i>
<b>BED SENSOR DELAY</b>	OFF / 02 / 04 / 08 (Seconds)	This setting allows a delay to be introduced from the bed sensor before the dementia controller detects an out of bed condition. The range is none (00) 2,4 or 8 seconds.
<b>ROOM ALARM TYPE</b>	CALL / PRIORITY / EMERGENCY	Selects the type of call generated by the room profile alarm. The menu structure prevents the doors from being set to a lower call level than the room.
<b>X4 ALARM TYPE</b>	*CALL / *PRIORITY / EMERGENCY	Selects the type of call generated by the X4 CORRIDOR DOOR contact & X5 PATIO DOOR contact. *The menu structure prevents the doors from being set to a lower alarm type than the room. If the Room Alarm Type is set to Call, the door alarm may be set to Call, Priority or Emergency. If the Room Alarm Type is set to Priority, the door alarm may be set to Priority or Emergency. If the Room Alarm Type is set to Emergency, the door alarm can only be set to Emergency.
<b>X5 ALARM TYPE</b>	*CALL / *PRIORITY / EMERGENCY	
<b>ROOM USER ID</b>	OFF / 251 / 252 253 / 254	Selects the User ID generated by the room profile alarm. This can be used to generate a secondary address from the room for example "BEDROOM 10 DEMENTIA ALARM"
<b>X4 USER ID</b>	OFF / 251 / 252 253 / 254	Selects the User ID generated by the X4 Door Contact input. This can be used to generate a secondary address from the room for example "BEDROOM 10 CORRIDOR DOOR"
<b>X5 USER ID</b>	OFF / 251 / 252 253 / 254	Selects the User ID generated by the X5 Door Contact input. This could be used to generate a secondary address from the room for example "BEDROOM 10 PATIO DOOR"
<b>ALARM RELAY</b>	ON / OFF	The unit is fitted with an auxiliary relay to trigger third party alarm systems and pager systems. This is disabled by default.
<b>AUTO OFF TIMER</b>	OFF / 5 / 6 / 7 / 8 9 / 10 / 11 / 12 (Hours)	The unit can automatically switch off after a number of hours. For example it is switched on when the resident is put to bed but automatically switches off in the morning. The range is immediate 5 to 12 hours.
<b>BED SENSOR CPR</b>	ON / OFF	When used in conjunction with later versions of the Intercall Call Management Software, the out of bed activity is silently monitored by the software. However, this function is not compatible with earlier systems and must be disabled.
<b>MIN ENSUITE TIME</b>	02 / 04 / 08 (Seconds)	Selects the minimum length of time that the Ensuite PIR will need to be activated before the light switch-over & cue timer is enabled. This allows alteration of the ensuite/room detection performance. The range is 2, 4 or 8 seconds.
<b>AUTO RESET</b>	ON / OFF	Once the room alarm is activated, if the resident returns to be the bed the unit can be configured to automatically reset the room alarm. This function can be disabled so a member of staff must visit to reset the room alarm on the controller.



## Zoning Configuration.

The **INTERCALL** system features comprehensive zoning facilities which can cope with most zoning requirements. The principle of zoning is to enable calls to be displayed only in the area from which they originate. This could be achieved by installing separate systems but this does not provide 'master' displays where all calls can be shown or the ability to display emergency 'crash' calls throughout the building to alert other members of staff.

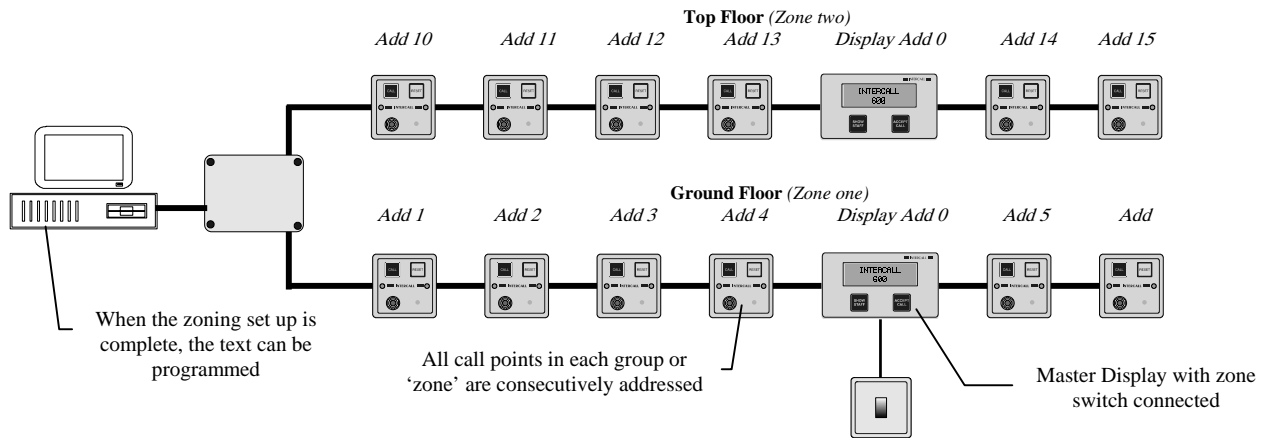

With the INTERCALL system, the zoning is configured and controlled by the display units. They have terminals for the zone switch and built in menu functions, which are used to configure the zone requirements. When a system is zoned, we must concentrate on the call point addresses and disregard the text that is associated to that address as this will need to be re-programmed when the system is commissioned.

### Additional Equipment Required.

If a system is to be zoned, you will need to re-program the text. See page 57 *Custom Configuration* for more information. If the zoning configuration is to be changed by the staff (e.g Day/Night operation) we will need a zone switch or time switch for automatic switching.

### Call Points

When a system is zoned, we effectively have call points in separate groups which are to be treated as the zones. (See the diagram above) All the call points in each group must have consecutive addresses.

### Display Units

We also have displays arranged in groups these are called **display addresses**. All displays in the same group must be set to the same **display address**. The **zone switch** is connected to one display in each group, this display is the **master display** for that group.

### Zone Switch

The **Zone Switch** is simply a closing contact, which is connected to the chosen **master display** for each **display address** group. It may be a simple manual switch, time switch or automatic closing contact. If the contact is open circuit, then all displays in that **display address** group are 'global' and they will respond to all call points on the system. This 'global' mode is often used as one of the zone settings.

### Display Address Windows

The mechanism by which the zoning is programmed at the LCD Displays, is based around three **address windows**, these are called 'Zone A', 'Zone B' and 'Zone C'. Each **address window** has a 'Lower Address' setting and a 'Higher Address' setting. When the 'Zone Switch' is operated, it selects either global (all addresses) or one of the three **address windows**. Pages 35 and 44 detail the connections to be made on the LCD Display units which select the **address window** which that group of addresses will use. Page 59 details the setting of the **address windows** 'Zone A', 'Zone B' and 'Zone C'.

### Display Menu - Display Address 00.

There are 16 available display addresses from 00 to 15. When display address 00 is used, the settings for the address windows 'Zone A', 'Zone B' and 'Zone C' are set up individually on all displays. This allows displays to be controlled by a single switch, but to have different address window settings.

Display Menu - Display Address 01 to 07.

When display addresses 01 to 07 are used, the settings for the address windows 'Zone A', 'Zone B' and 'Zone C' are set up on the master display and transmitted to all other displays on the same **display address**. When using display address 01 to 07, only the master display can access the 'Zone A', 'Zone B' and 'Zone C' settings within the display menu. These display addresses must be used when **Remote Sounders** are required to be zoned.

Display Menu - Second Tone.

The **Second Tone** may be considered as an additional **address window**. Any active call point within the Second Tone Low and High address range will make the LCD Display sound (Using the solid alternative alarm tone) regardless of the zone settings. This is ideally used for exit doors or specific call points which are to be alerted throughout all zones.

Display menu - Show All Calls.

This setting allows calls from all zones to be displayed, but only calls within the selected **address window** will sound the audible alarm tone. This function can be enabled or disabled at each display within the display menu settings.

Display menu – Priority Calls. – Selected Products Only.

This setting allows priority calls from all zones outside the selected **address window** to be displayed and generate the audible alarm tone. This function can be set to 'All Zones' which will show and sound for priority calls from all zones on the system or 'Own Zone Only' which will not show priority calls outside the **address window**.

Display menu – Emergency Calls.

This setting allows emergency calls from all zones outside the selected **address window** to be displayed and generate the audible alarm tone. This function can be set to 'All Zones' or 'Own Zone Only' which will not show emergency calls outside the **address window**.

Display menu – Accept Attack Calls.

This setting allows attack calls to be accepted on the display using the accept button. This function is specific to the each display and prevents unauthorized reset of attack calls where displays are in vulnerable or common locations.

Remote Sounders

The Remote Sounder only features basic zoning facilities and we recommend using LCD displays rather than Remote Sounders where a system is to be zoned. Remote Sounders pick up the zoning information from a **master display** unit set to the same **display address**. When zoning Remote Sounders, you must use display Address 01 to 15 and set up the address window values on the master display. The **display address** is set up on the Remote Sounder using DIL switches.

Power Supplies.

Zoning does not affect the quantity or location of power supply units on the system. This must be calculated in accordance with the Wiring Limitation. (See page 17)

Overdoor Lights.

Zoning does not affect the operation of the overdoor lights. They may be set to a manual **address window** with the use of two sets of DIP switches which set the 'lower' and 'higher' address limits. See page 37 for more information.

Thermal Printer and Universal Interface (L747).

The L747 Interface and Thermal Printer will record all system activity regardless of zoning. See page 42

Alphanumeric Pagers and Universal Interface (L747).

The L747 Interface and Alphanumeric Pagers will record all system activity regardless of zoning. The L747 can be configured so that only emergency or attack calls are sent to the pagers.

PC Logging and Alphanumeric Paging.

By using the Call Management Software, it is possible to zone individual alphanumeric pagers to any number of zones and using it with the Intercall 700 system, it is possible to 'route' specific call types, locations or users to specific alphanumeric pagers.

Text Programming.

Once the zone set up is complete, the call point text can be programmed into the power supply and downloaded to the system.

## Zoning – Example 1.

In the example below, we have 2 zones with 9 call points and 2 display units on each zone. They are to be operated independently and the LCD Displays are only to show calls local to the zone. The 'Options' described below allow for this to be switched (say for day/night staffing levels) and to allow emergency or 'attack' calls to be shown on all zones.

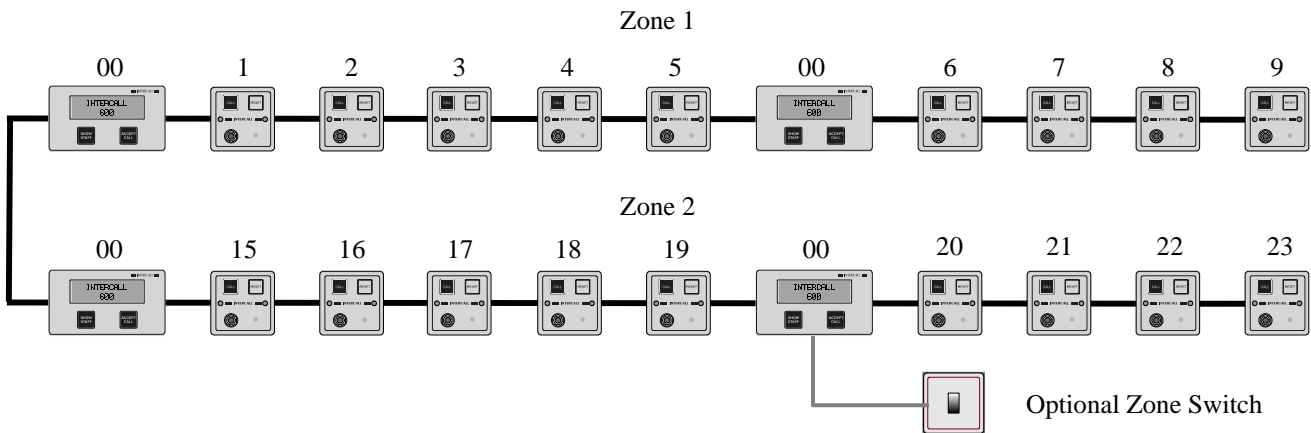

### Setting up the Call Points.

- Set up call points on the first zone with consecutive addresses. *The zone 1 example above starts at address 1 and continues to address 9.*
- Leaving a gap to allow for future expansion, set up call points on the second zone with consecutive addresses. *The zone 2 example above starts at address 15 and continues to address 23.*
- Continue the above procedure on all further zones, leaving gaps for future expansion between all zones. *The zone 3 example above starts at address 30 and continues to address 38.*

### Setting up the LCD Display Units.

- Set up **all** displays in zone 1 as follows:
- **DISPLAY ADDRESS 00.** *We wish the displays in both zone 1 and zone 2 to be switched together, so we have used the same display address on all LCD displays. As we are using display address 0 the address window settings will need to be set up on all displays.*
- **ZONE A LOW ADD 1,ZONE A HIGH ADD 9.** *This address window 'Zone A' is set to receive only local calls from zone 1.*
- Set up **all** displays in zone 2 as follows:
- **DISPLAY ADDRESS 00.** *We wish the displays in both zone 1 and zone 2 to be switched together, so we have used the same display address on all LCD displays.*
- **ZONE A LOW ADD 15,ZONE A HIGH ADD 23.** *This address window 'Zone A' is set to receive only local calls from zone 1.*

### Zone Connection.

- Select one LCD Display to be the 'master' (*It can be any display in any zone and in the example above it is one of the displays on zone 2*) and connect the terminals on the rear of the unit to select **address window A**. For information on the connections for the zone switch, please refer to page 35

### Options.

- Should you wish to switch the zone (Say in the daytime, you wish to see all calls on all displays and at night time the calls are only displayed locally) Connect a switch to select either 'global' or **address Window A**
- If you set the all display menus to **EMERGENCY CALLS = ALL ZONES**, Then 'Emergency' or 'Attack' calls from either zone 1 or zone 2 will be shown on all LCD display units.

## Zoning – Example 2.

In the example below, we have 2 zones with 9 call points and 2 display units on each zone. There are two modes of operation; 1. Independently (LCD Displays show calls within the zone) and 2. All calls are shown in zone 2 but all LCD displays in zone 1 are silent and do not sound. Emergency calls are to stay within the local zone.

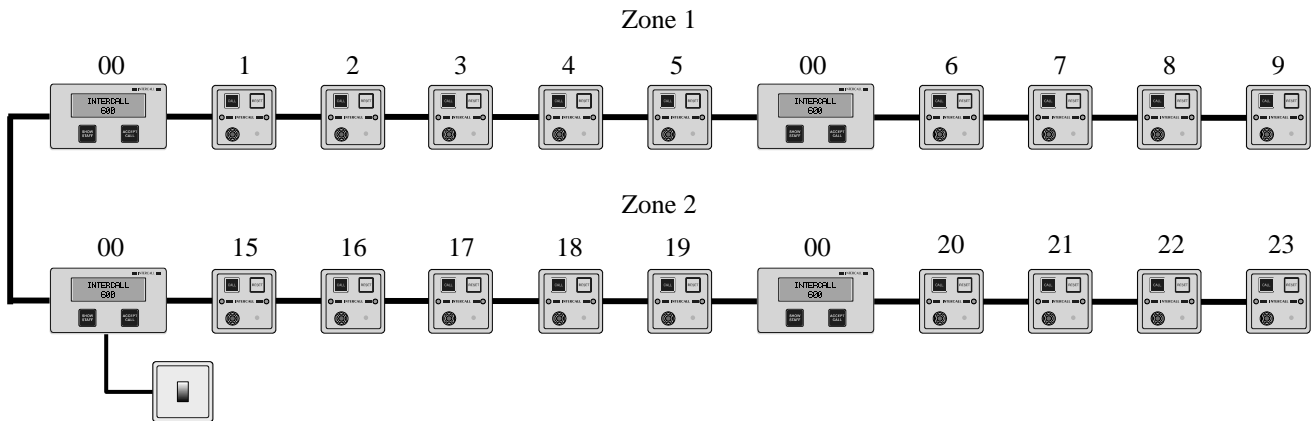

### Call Points.

- Call points are set up with consecutive addresses in each zone, with a gap between zones as per example 1.

### LCD Displays.

- Set up **all** displays in zone 1 as follows:
- **DISPLAY ADDRESS 00.** We wish the displays in both zone 1 and zone 2 to be switched together, so we have used the same **display address** on all LCD displays. As we are using **display address 0** the **address window** settings will need to be set up on all displays.
- **ZONE A LOW ADD 1,ZONE A HIGH ADD 9.** We have set up two **address windows** on the LCD displays in zone 1. The first **address window** 'Zone A' is set to receive only local calls from zone 1.
- **ZONE B LOW ADD 215,ZONE B HIGH ADD 215.** The second **address window** is set up away from any call point address (at address 215) so when using the 'Zone B' setting, the display will not respond to any call.
- **EMERGENCY CALLS = OWN ZONE ONLY.** We have set Emergency calls = own zone only to prevent emergency calls crossing the **address window** settings. This will mean that in zone 1, when **address window** 'Zone B' is selected, no emergency calls will sound in zone 1.
- Set up **all** displays in zone 2 as follows:
- **DISPLAY ADDRESS 00.** We wish the displays in both zone 1 and zone 2 to be switched together, so we have used the same **display address** on all LCD displays.
- **ZONE A LOW ADD 15,ZONE A HIGH ADD 23.** We have set up two **address windows** on the LCD displays in zone 2. The first **address window** 'Zone A' is set to receive only local calls from zone 2.
- **ZONE B LOW ADD 1,ZONE B HIGH ADD 23.** The second **address window** is set up to receive calls from both zone 1 call points and zone 2 call points.
- **EMERGENCY CALLS = OWN ZONE ONLY.** We have set Emergency calls = own zone only to prevent emergency calls crossing the **address window** settings. This will mean that in zone 2, when **address window** 'Zone A' is selected, no emergency calls from zone 1 will sound in zone 2.

### Zone Switch.

- Connect the zone switch to select either 'Address Window A' or 'Address Window B'. When the zone switch is operated, it will select the **address windows** which will be used by all the LCD display units, on both zones. For information on the connections for the zone switch, please refer to page 35

Emergency calls from both zone 1 & zone 2 can sound, if required, by setting **EMERGENCY CALLS = ALL ZONES**

### Zoning – Example 3.

In the example below, we have 2 zones with 8 call points, 2 display units and one remote sounder on each zone. There is a zone switch in each zone which controls the displays in the local zone only. There are two modes of operation; **1.** LCD Displays and Remote Sounders show/sound for calls within their own zone only, and **2.** Show calls /sound for calls from zone 1 and 2 on the local displays and sounders.

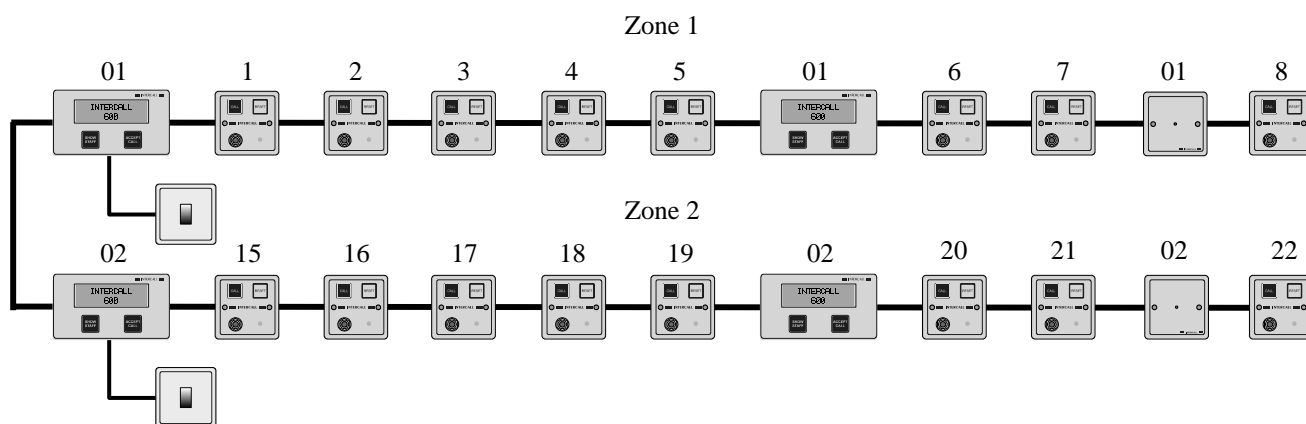

#### Call Points.

- Call points are set up with consecutive addresses in each zone, with a gap between zones as per example 1.

#### LCD Displays.

- Set up the master display in zone 1 as follows:
- **DISPLAY ADDRESS 01.** We wish all displays in zone 1 to be switched together, but not affect the displays in the other zones. As we are using *display address 1* the *address window* settings can only be set on the *master display* and all other displays, and remote sounders, set to *display address 1* will pick up the settings.
- Set: **ZONE A LOW ADD 1,ZONE A HIGH ADD 8.** The first *address window* 'Zone A' is set to receive only local calls from zone 1.
- Set: **ZONE B LOW ADD 1,ZONE B HIGH ADD 22.** The second *address window* 'Zone B' is set to receive calls from both zone 1 and zone 2.
- Set: **ZONE C LOW ADD 215,ZONE C HIGH ADD 215.** The second *address window* is set up away from any call point address (at address 215) so when using the 'Zone B' setting, the displays will not respond to any call.
- Set the Remote Sounder to **display address 01.** The remote sounders will pick up the *address window* settings which are entered into the master display set to *display address 1* in zone 1.
- Set up the master display in zone 2 as follows:
- **DISPLAY ADDRESS 02.** We wish all displays in zone 2 to be switched together, but not affect the displays in zone 1.
- Set: **ZONE A LOW ADD 15,ZONE A HIGH ADD 22.** The first *address window* 'Zone A' is set to receive only local calls from zone 2. As we are using *display address 2* the *address window* settings can only be set on the master display and all other displays, and remote sounders, set to *display address 2* will pick up the settings.
- Set: **ZONE B LOW ADD 1,ZONE B HIGH ADD 22.** The second *address window* 'Zone B' is set to receive calls from both zone 1 and zone 2.
- Set the Remote Sounder to **display address 02.** The remote sounders will pick up the *address window* settings which are entered into the master display set to *display address 2* in zone 2.

#### Zone Switches.

- Connect a zone switch in each zone to select either 'Address Window A' or 'Address Window B'. When the zone switch is operated, it will select the *address windows* for all displays in the local zone only. It will not affect displays in the other zone. For information on the connections for the zone switch, please refer to page 35

If you do not wish to switch the zone setting but you wish to use Remote Sounders, fit links to the master displays in zone 1 and zone 2 to permanently select 'Address window A' and enter the settings into the master displays.

## Zoning – Example 4.

In the example below, we have 3 zones with 10 call points and 2 display units on each zone. There is a three position zone switch in each zone which controls the displays in the local zone only. There are three modes of operation; 1. Independently (LCD Displays show calls within the zone) 2. Show calls from all zones on the local displays. 3. Local displays to show no calls from any zone.

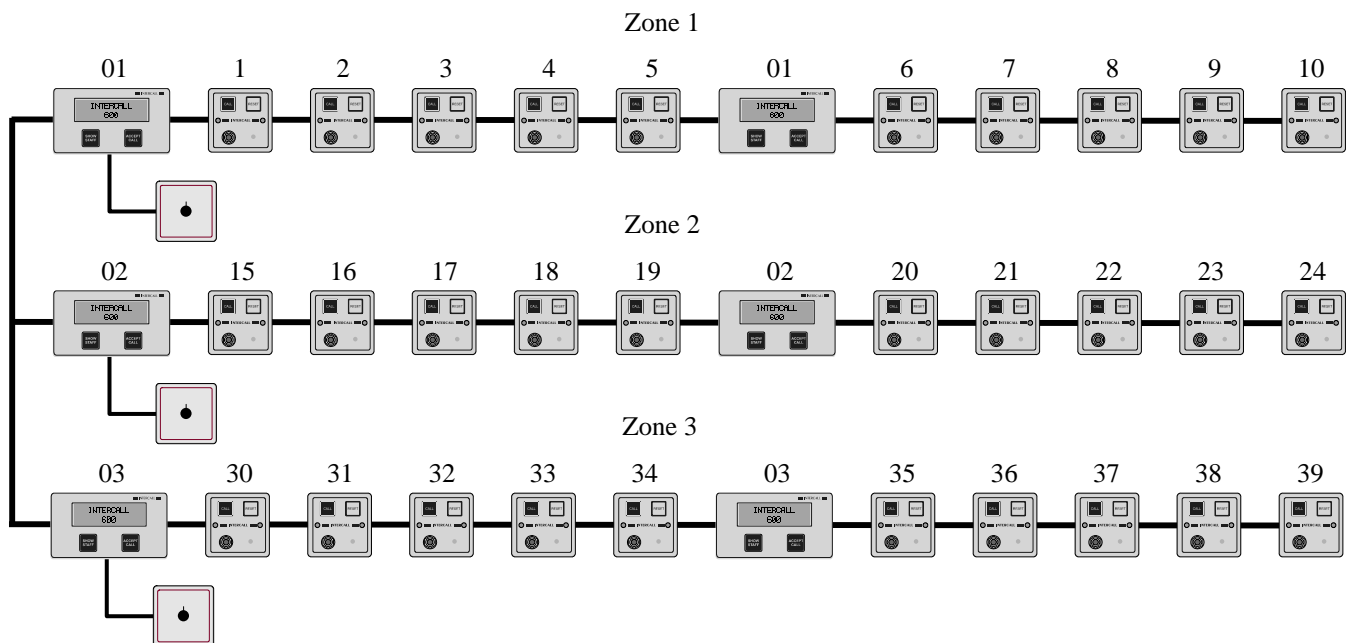

### Call Points.

- Call points are set up with consecutive addresses in each zone, with a gap between zones as per example 1.

### LCD Displays.

- Set up the master display in zone 1 as follows:
- **DISPLAY ADDRESS 01.** We wish all displays in zone 1 to be switched together, but not affect the displays in the other zones. As we are using **display address 1** the **address window** settings can only be set on the **master display** and all other displays set to **display address 1** will pick up the settings.
- Set: **ZONE A LOW ADD 1,ZONE A HIGH ADD 10.** The first **address window** 'Zone A' is set to receive only local calls from zone 1.
- Set: **ZONE B LOW ADD 1,ZONE B HIGH ADD 39.** The second **address window** 'Zone B' is set to receive calls from zones 1,2 and 3.
- Set: **ZONE C LOW ADD 215,ZONE C HIGH ADD 215.** The third **address window** is set up away from any call point address (at address 215) so when using the 'Zone C' setting, the displays will not respond to any call.
- Set up the master display in zone 2 as follows:
- **DISPLAY ADDRESS 02.** We wish all displays in zone 2 to be switched together, but not affect the displays in the other zones. As we are using **display address 2** the **address window** settings can only be set on the **master display** and all other displays set to **display address 2** will pick up the settings.
- Set: **ZONE A LOW ADD 15,ZONE A HIGH ADD 24.** The first **address window** 'Zone A' is set to receive only local calls from zone 2.
- Set: **ZONE B LOW ADD 1,ZONE B HIGH ADD 39.** The second **address window** 'Zone B' is set to receive calls from zones 1,2 and 3.
- Set: **ZONE C LOW ADD 215,ZONE C HIGH ADD 215.** The third **address window** is set up away from any call point address (at address 215) so when using the 'Zone C' setting, the displays will not respond to any call.

Zoning example 4 continues on the next page.....

- Set up the master display in zone 3 as follows:
- **DISPLAY ADDRESS 03.** *We wish all displays in zone 2 to be switched together, but not affect the displays in the other zones. As we are using **display address 3** the **address window** settings can only be set on the **master display** and all other displays set to **display address 3** will pick up the settings.*
- Set: **ZONE A LOW ADD 30,ZONE A HIGH ADD 39.** *The first **address window** 'Zone A' is set to receive only local calls from zone 3.*
- Set: **ZONE B LOW ADD 1,ZONE B HIGH ADD 39.** *The second **address window** 'Zone B' is set to receive calls from zones 1,2 and 3.*
- Set: **ZONE C LOW ADD 215,ZONE C HIGH ADD 215.** *The third **address window** is set up away from any call point address (at address 215) so when using the 'Zone C' setting, the displays will not respond to any call.*

#### **Zone Switches.**

- Connect a three position zone switch in each zone to select either 'Address Window A' , 'Address Window B' or 'Address window C'. *When the zone switch is operated, it will select the **address windows** for all displays in the local zone only. It will not affect displays in the other zone.* For information on the connections for the zone switch, please refer to page 35

The above example will require a three position zone switch, prices and availability are available on request. As there are 16 independent display addresses, the above could be repeated up to a maximum of 16 zones. As one of the three settings on the zone switch is 'sound for calls in all zones', we could use the 'global' setting as one of the three positions and we would have the 'Zone C' setting available for another range of call points.

As with the other examples, we could set the **EMERGENCY CALLS** to either **ALL ZONES** or **OWN ZONE ONLY**.

If a 'supervisors' display was required to show all call activity but only sound for emergencies, this is simply added anywhere on the network cabling and set to **SOUND FOR = EMERGENCY CALLS ONLY**. Obviously, it could be set to sound for all calls if required.

We hope that the examples have given an insight into some of the possibilities with the Intercall system of zoning. But if you wish to discuss your zoning requirements, please contact your supplier or the factory technical support department.

**IMPORTANT**  
**EVERY CALL**  
**POINT MUST**  
**BE SET TO A**  
**UNIQUE**  
**ADDRESS.**



**Factory Text Page 1 of 2.**

SWITCHES	ADD	TEXT MESSAGE
Duuuuuuu	001	BEDROOM 1
uDuuuuuu	002	BEDROOM 2
DDuuuuuu	003	BEDROOM 3
uuDuuuuu	004	BEDROOM 4
DuDuuuuu	005	BEDROOM 5
uDuuuuuu	006	BEDROOM 6
DDDuuuuu	007	BEDROOM 7
uuuDuuuu	008	BEDROOM 8
DuuDuuuu	009	BEDROOM 9
uDuDuuuu	010	BEDROOM 10
DDuDuuuu	011	BEDROOM 11
uuDDuuuu	012	BEDROOM 12
DuDDuuuu	013	BEDROOM 13
uDDDuuuu	014	BEDROOM 14
DDDDuuuu	015	BEDROOM 15
uuuuDuuu	016	BEDROOM 16
DuuuDuuu	017	BEDROOM 17
uDuuDuuu	018	BEDROOM 18
DDuuDuuu	019	BEDROOM 19
uuDuDuuu	020	BEDROOM 20
DuDuDuuu	021	BEDROOM 21
uDDuDuuu	022	BEDROOM 22
DDDuDuuu	023	BEDROOM 23
uuuDuuu	024	BEDROOM 24
DuuDDuuu	025	BEDROOM 25
uDuuDDuuu	026	BEDROOM 26
DDuuDDuuu	027	BEDROOM 27
uuDDDuuu	028	BEDROOM 28
DuDDDuuu	029	BEDROOM 29
uDDDDuuu	030	BEDROOM 30
DDDDDuuu	031	BEDROOM 31
uuuuuDuu	032	BEDROOM 32
DuuuuDuu	033	BEDROOM 33
uDuuuDuu	034	BEDROOM 34
DDuuuDuu	035	BEDROOM 35
uuDuuDuu	036	BEDROOM 36
DuDuuDuu	037	BEDROOM 37
uDDuDuDu	038	BEDROOM 38
DDDuDuDu	039	BEDROOM 39
uuuDuDuDu	040	BEDROOM 40
DuuDuDuDu	041	BEDROOM 41
uDuuDuDuDu	042	BEDROOM 42
DDuuDuDuDu	043	BEDROOM 43
uuDDuDuDu	044	BEDROOM 44
DuDDuDuDu	045	BEDROOM 45
uDDDuDuDu	046	BEDROOM 46
DDDDuDuDu	047	BEDROOM 47
uuuuDDuDu	048	BEDROOM 48
DuuuDDuDu	049	1ST FLR BED 1
uDuuDDuDu	050	1ST FLR BED 2
DDuuDDuDu	051	1ST FLR BED 3
uuDuDDuDu	052	1ST FLR BED 4
DuDuDDuDu	053	1ST FLR BED 5

SWITCHES	ADD	TEXT MESSAGE
uuDDuDDu	108	2ND FLR BED 28
DuDDuDDu	109	2ND FLR BED 29
uDDDuDDu	110	2ND FLR BED 30
DDDDuDDu	111	2ND FLR BED 31
uuuuDDDu	112	2ND FLR BED 32
DuuuDDDu	113	TOILET 1
uDuuDDDu	114	TOILET 2
DDuuDDDu	115	TOILET 3
uuDuDDDu	116	TOILET 4
DuDuDDDu	117	TOILET 5
uDDuDDDu	118	TOILET 6
DDDuDDDu	119	TOILET 7
uuuDDDDu	120	TOILET 8
DuuDDDDu	121	TOILET 9
uDuuDDDDu	122	TOILET 10
DDuDDDDu	123	TOILET 11
uuDDDDDu	124	TOILET 12
DuDDDDDu	125	TOILET 13
uDDDDDu	126	TOILET 14
DDDDDu	127	TOILET 15
uuuuuuuD	128	BATHROOM 1
DuuuuuuD	129	BATHROOM 2
uDuuuuuD	130	BATHROOM 3
DDuuuuuD	131	BATHROOM 4
uuDuuuuD	132	BATHROOM 5
DuDuuuuD	133	BATHROOM 6
uDDuuuuD	134	BATHROOM 7
DDDuuuuD	135	BATHROOM 8
uuuDuuuD	136	BATHROOM 9
DuuDuuuD	137	BATHROOM 10
uDuDuuuD	138	LOUNGE 1
DDuDuuuD	139	LOUNGE 2
uuDDuuuD	140	LOUNGE 3
DuDDuuuD	141	LOUNGE 4
uDDDuuuD	142	LOUNGE 5
DDDDuuuD	143	DINING ROOM 1
uuuuDuuD	144	DINING ROOM 2
DuuuDuuD	145	DINING ROOM 3
uDuuDuuD	146	TREATMENT RM 1
DDuuDuuD	147	TREATMENT RM 2
uuDuDuuD	148	TREATMENT RM 3
DuDuDuuD	149	TREATMENT RM 4
uDDuDuuD	150	TREATMENT RM 5
DDDuDuuD	151	DAY ROOM 1
uuuDDuuD	152	DAY ROOM 2
DuuDDuuD	153	DAY ROOM 3
uDuuDDuuD	154	DAY ROOM 4
DDuDDuuD	155	SHOWER 1
uuDDDuuD	156	SHOWER 2
DuDDDuuD	157	SHOWER 3
uDDDDuuD	158	SHOWER 4
DDDDDuuD	159	SHOWER 5
uuuuDuD	160	SHOWER 6
DuuuuDuD	161	SHOWER 7

Turn call point upside down, with terminals at the bottom and read as follows:  
u = Switch up (towards ON) D = Switch down (away from ON)

**VERY IMPORTANT: EACH CALL POINT MUST HAVE A UNIQUE ADDRESS SETTING**

**Factory Text Page 2 of 2.**

SWITCHES	ADD	TEXT MESSAGE	SWITCHES	ADD	TEXT MESSAGE
uDDuDDuu	054	1ST FLR BED 6	uDuuuDuD	162	SHOWER 8
DDDuDDuu	055	1ST FLR BED 7	DDuuuDuD	163	SHOWER 9
uuuDDDu	056	1ST FLR BED 8	uuDuDuD	164	DOOR 1
DuuDDDu	057	1ST FLR BED 9	DuDuDuD	165	DOOR 2
uDuuDDu	058	1ST FLR BED 10	uDDuDuD	166	DOOR 3
DDuDDDu	059	1ST FLR BED 11	DDDuuDuD	167	DOOR 4
uuDDDDu	060	1ST FLR BED 12	uuuDuDuD	168	DOOR 5
DuDDDDu	061	1ST FLR BED 13	DuuDuDuD	169	DOOR 6
uDDDDDu	062	1ST FLR BED 14	uDuuDuD	170	DOOR 7
DDDDDu	063	1ST FLR BED 15	DDuDuDuD	171	DOOR 8
uuuuuuDu	064	1ST FLR BED 16	uuDDuDuD	172	DOOR 9
DuuuuuDu	065	1ST FLR BED 17	DuDDuDuD	173	DOOR 10
uDuuuuDu	066	1ST FLR BED 18	uDDDuDuD	174	DOOR 11
DDuuuuDu	067	1ST FLR BED 19	DDDDuDuD	175	DOOR 12
uuDuuuDu	068	1ST FLR BED 20	uuuuDDuD	176	DOOR 13
DuDuuuDu	069	1ST FLR BED 21	DuuuDDuD	177	DOOR 14
uDDuuuDu	070	1ST FLR BED 22	uDuuDDuD	178	DOOR 15
DDDuuuDu	071	1ST FLR BED 23	DDuuDDuD	179	FRONT DOOR
uuuDuuDu	072	1ST FLR BED 24	uuDuDDuD	180	BACK DOOR
DuuDuDu	073	1ST FLR BED 25	DuDuDDuD	181	FIRE DOOR 1
uDuuDuDu	074	1ST FLR BED 26	uDDuDDuD	182	FIRE DOOR 2
DDuDuDu	075	1ST FLR BED 27	DDDuDDuD	183	FIRE DOOR 3
uuDDuDu	076	1ST FLR BED 28	uuuDDDuD	184	FIRE DOOR 4
DuDDuDu	077	1ST FLR BED 29	DuuDDDuD	185	FIRE DOOR 5
uDDDuDu	078	1ST FLR BED 30	uDuuDDuD	186	FIRE DOOR 6
DDDDuDu	079	1ST FLR BED 31	DDuDDDuD	187	FIRE DOOR 7
uuuuDuDu	080	1ST FLR BED 32	uuDDDDuD	188	FIRE DOOR 8
DuuuDuDu	081	2ND FLR BED 1	DuDDDDuD	189	FIRE DOOR 9
uDuuDuDu	082	2ND FLR BED 2	uDDDDDuD	190	FIRE DOOR 10
DDuuDuDu	083	2ND FLR BED 3	DDDDDuD	191	HAIRDRESSER
uuDuDuDu	084	2ND FLR BED 4	uuuuuuDD	192	FRONT GARDEN
DuDuDuDu	085	2ND FLR BED 5	DuuuuuDD	193	REAR GARDEN
uDDuDuDu	086	2ND FLR BED 6	uDuuuuDD	194	PATIO
DDDuDuDu	087	2ND FLR BED 7	DDuuuuDD	195	CONSERVATORY 1
uuuDDuDu	088	2ND FLR BED 8	uuDuuuDD	196	CONSERVATORY 2
DuuDDuDu	089	2ND FLR BED 9	DuDuuuDD	197	FREEZER 1
uDuuDDuDu	090	2ND FLR BED 10	uDDuuuDD	198	FREEZER 2
DDuDDuDu	091	2ND FLR BED 11	DDDuuuDD	199	FREEZER 3
uuDDDuDu	092	2ND FLR BED 12	uuuDuDuDD	200	DRUG CUPBOARD1
DuDDDuDu	093	2ND FLR BED 13	DuuDuDuDD	201	DRUG CUPBOARD2
uDDDDuDu	094	2ND FLR BED 14	uDuuDuDuDD	202	DRUG CUPBOARD3
DDDDDuDu	095	2ND FLR BED 15	DDuDuDuDD	203	LIFT 1
uuuuuDDu	096	2ND FLR BED 16	uuDDuDuDD	204	LIFT 2
DuuuuDDu	097	2ND FLR BED 17	DuDDuDuDD	205	TV ROOM 1
uDuuuDDu	098	2ND FLR BED 18	uDDDuDuDD	206	TV ROOM 2
DDuuuDDu	099	2ND FLR BED 19	DDDDuDuDD	207	CHAPEL
uuDuDuDDu	100	2ND FLR BED 20	uuuuDuDD	208	HYDROTHERAPY
DuDuDuDDu	101	2ND FLR BED 21	DuuuDuDD	209	SWIMMING POOL
uDDuDuDDu	102	2ND FLR BED 22	uDuuDuDD	210	BEDROOM 12A
DDDuDuDDu	103	2ND FLR BED 23	DDuuDuDD	211	
uuuDuDuDDu	104	2ND FLR BED 24	uuDuDuDD	212	QUIET ROOM 1
DuuDuDuDDu	105	2ND FLR BED 25	DuDuDuDD	213	QUIET ROOM 2
uDuuDuDDu	106	2ND FLR BED 26	uDDuDuDD	214	TELEPHONE
DDuDuDDu	107	2ND FLR BED 27	DDDuDuDD	215	FIRE ALARM

Turn call point upside down, with terminals at the bottom and read as follows:

u = Switch up (towards **ON**) D = Switch down (away from **ON**)

**VERY IMPORTANT: EACH CALL POINT MUST HAVE A UNIQUE ADDRESS SETTING**

## L617 / L717 Configuration Switch Settings

The global system features are controlled by a bank of DIL switches fitted to the L617 and L717 Power Supplies. The switches are shown to the right and [ON] is upwards (towards the word ON) and [OFF] is down (away from the word ON). The tables below details the available settings.

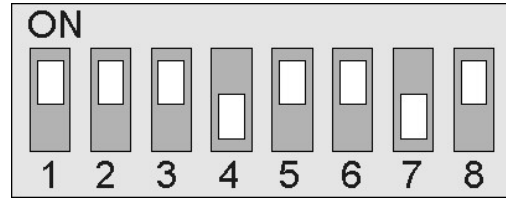

<b>L617 Power Supply CONFIGURATION SWITCH SETTINGS</b>		
<b>SW3</b>	<b>SW4</b>	<b>Time taken for an accepted call to return to the calling condition</b>
ON	ON	30 Seconds
ON	OFF	1 Minute
OFF	ON	2 Minutes
OFF	OFF	2 Minutes and 30 Seconds * <b>[Do not use these settings simultaneously]</b>
<b>SW5</b>	<b>SW6</b>	<b>Time taken for an un-answered call to convert to an emergency call</b>
ON	ON	Never convert to an emergency call
ON	OFF	2 Minutes and 30 Seconds * <b>[Do not use these settings simultaneously]</b>
OFF	ON	3 Minutes and 30 Seconds
OFF	OFF	6 Minutes and 30 Seconds
<b>SW</b>	<b>SWITCH ON</b>	<b>SWITCH OFF</b>
<b>SW1</b>	Enable Staff Present feature	Disable Staff Present feature
<b>SW2</b>	Disable Call Follower Sounder	Enable Call Follower Sounder
<b>SW7</b>	<i>Not used</i>	
<b>SW8</b>	<i>Not used</i>	

\* Do not use these settings simultaneously

<b>L717 Power Supply CONFIGURATION SWITCH SETTINGS</b>				
<b>SW3</b>	<b>SW4</b>	<b>SW5</b>	<b>Time for Accepted calls to return to their calling state</b>	<b>Time for an un-answered call to become a Priority call</b>
ON	ON	ON	1 Minute & 30 Seconds	2 Minutes & 30 Seconds
OFF	ON	ON	2 Minutes	3 Minutes & 30 Seconds
ON	OFF	ON	3 Minutes	2 Minutes & 30 Seconds
OFF	OFF	ON	4 Minutes	2 Minutes & 30 Seconds
ON	ON	OFF	1 Minute & 30 Seconds	6 Minutes & 30 Seconds
OFF	ON	OFF	2 Minutes	Never turn into a Priority call
ON	OFF	OFF	3 Minutes	3 Minutes & 30 Seconds
OFF	OFF	OFF	4 Minutes	Never turn into a Priority call
<b>SW</b>	<b>SWITCH ON</b>		<b>SWITCH OFF</b>	
<b>SW1</b>	Manual staff present feature only [Reset Button Present/Reset toggle]		Automatic Staff Present Feature only** [Reset Button Reset only]	
<b>SW2</b>	Disable call point follower sounder		Enable call point follower sounder	
<b>SW6</b>	No lost addresses logged by displays		lost addresses logged on displays	
<b>SW7</b>	Show location + User ID on system		User ID disabled	
<b>SW8</b>	Disable Nurse Present Auto Expiry Timer [Fixed at 10 minutes]		Enable Preset Auto Expiry Timer [Manual Reset Only]	

<b>L747SL SERIAL RS232 LEAD FOR SCOPE PAGERS, CMS LITE &amp; PROGRAMMING L747</b>		
<b>L747 25 way female Connector</b>	<b>Description</b>	<b>PC 9 way female Connector</b>
Pin 13	CTS <<<	Pin 4+7
Pin 14	TXD >>>	Pin 2
Pin 15	RXD <<<	Pin 3
Pin 17	RTS >>>	Pin 6+8
Pin 25	Signal Ground	Pin 5
<b>YOU WILL NEED TO USE THE SOFTWARE IF CHANGING THE PAGER ADDRESS OR L747 DATE AND TIME See Page 38</b>		

## Fault Finding Guide

### Call Point Faults.

#### FAULT

F1. Red Led on continuously or sounder beeping continuously or red and green leds showing continuously.

F2. Will not reset  
See also F9

F3. Call Point does not show or sound on display  
F4. Call Point shows incorrect call type  
See also F6

F5. Call Point Red Led flashes twice then goes into green flashing

F6. Call Address changes when calling but OK for Present/Visit. [L622Mk1 ONLY]

F7. Call Point sounds on display but LCD reads "1" " [Call Number but no text]

F8. Wrong address shows when Call Point calling  
If L622 then see fault F6

F9. Call Point randomly "Ghost Calls"  
See Also F2

#### CAUSE

Illegal Switch Setting

Ceiling pull switch faulty (i.e. shorted)  
Ceiling pull switch wiring short circuit  
Latching pull switch fitted  
Pear Lead faulty (i.e. shorted)

Two call points set to the same address  
No power to call point or network volts too low  
Two Master power supplies on the wiring  
Address windows not set up correctly on LCD(s)

Call point receives accept signal on the network

L output shorted to 0v.  
**L622Mk1 ONLY – All other call points do not use the same circuit**

No text has been programmed for that address.  
Call point on wrong address [see fault F3,F8]

Wrong text has been programmed for that address  
DIP Switches incorrectly set on call point  
Faulty DIP switch on call point  
If L622 then see fault F6

Ceiling pull switch damp (condensation or leak)  
Damaged wiring on "X" connection  
Damaged pear lead or plug  
Excessive electrical 'noise' or static on site

#### CURE

Set Call Point Switches  
See Pages 31 (600) or Page 47 (700) and page 72

Disconnect or eliminate pull switch  
Disconnect or eliminate wiring.  
Must be momentary pull switch  
Remove Pear Lead

All call points *must* have a unique address  
Check if call point Red Led is flashing.  
Only one master power supply per system.  
Remove all zone links & try again or check set-up.  
Refer to page 61 for zoning configuration

Usually due to short on the Network.  
Damp Network Cable  
Damaged Network Cable  
Call Accepted at display  
Display accept button stuck down  
Remove L connection from call point.

If this is on all displays check programming sheet  
If only on one display, download text from PSU.

If this is on all displays check programming sheet  
Re-check DIP Switches  
Replace or eliminate call point.

Check ceiling pull switch  
Check Wiring..  
Remove or replace pear lead  
Check site or contact supplier for filter units.

## Display Faults

### **FAULT**

F10. Liquid Crystal Display totally blank

F11. LCD reads Vx.xx or SWxxxx continuously

F12. Display Shows calls but does not sound Call

F13. See also F3

F14. Display will not accept calls.

F15. Display will not accept text download

F16. Display text corrupted

F17. Display menu text corrupted

Display sounds single tone (not warble)

Cannot gain access to address windows within menus

### **CAUSE**

No power to display

Excessive volt drop on Network cable

Network Cable Short

No input to Booster PSU

Master PSU not running

Display set up to sound for Emergency calls only

Display Zoning set incorrectly

DAY or NIGHT alarm level set at minimum

Feature disabled in the display menu

Wrong type of system (IE L628 running on L717PSU)

Excessive Cable Capacitance on the system

Wrong type of system (IE L628 running on L717PSU)

Battery must be fitted to the PSU when downloading

Units connected the Network with power connected

Second Tone setting active

Display not in master mode

### **CURE**

Check connections with a meter.

Must measure minimum 9Volts at Network Cable.

Remove or eliminate part(s) of the system

See page 59

See page 35 or 44

See page 59

See page 3

See page 3

Download text from Master PSU directly

Unit will need to be returned to the factory or re-programmed using the LIM device.

Disabled in display menu See page 59

See pages 35,44 & 61

## Power Supply Faults

### **FAULT**

F18. PSU Yellow LED not illuminated

F19. PSU Green LED not illuminated

F20. Master PSU Red LED not flashing

F21. PCB Sounder beeping continuously

F22. Master PSU Beeper Sounding once per second  
and PSU Yellow LED Not Illuminated

F23. No output from booster

F24. No Output from master power supply

F25. Display text corrupted after download

### **CAUSE**

No mains power connected  
Transformer damaged during installation

1 Amp fuse blown  
PCB damaged during installation

Network short  
Network Device connections reversed  
Flat Battery\*  
Output Overloaded  
PCB damaged during installation

*\* The Power Supply is not designed to re-charge a completely flat battery & operate the call system simultaneously. Completely flat batteries must be charged using a specialist Sealed Lead Acid battery charger or a power supply which has no external load connected.*

Unit running from back up battery

No input connected to booster  
No output from master Supply.  
Check Yellow & Green LED's

Network Cable Short  
Network Device connections reversed  
PSU Output Power Transistor Damaged

Text corrupted within power supply.  
Battery must be connected when downloading

### **CURE**

Check Supply.

Check fuse.

Remove or eliminate Network spurs

Use battery charger to re-charge battery or replace battery.  
Max Load 100 Current Units per PSU

Check mains incoming supply

Check cable from master to booster.

Remove or eliminate Network Spurs

Connect to computer and re-program.

## L747 Universal Interface Faults

### **FAULT**

F25A. L747 Red LED not flashing

F26. Printer Showing incorrect date or time

F27. Extra Line feed space in between printout

F28. Printer/Pager reporting 'lost' devices

F29. RS232 data input/output problems

F30. L747 + DPU414 Thermal Printer problems

F31. L747 + SCOPE Serial RS232 pager mode

### **CAUSE**

No Connection to Network  
No Supply to Network  
No output device connected to 25way socket on L747  
Output device giving 'busy' signal  
L747 DIL switches set incorrectly.  
DPU414 DIL Switches set incorrectly

British Summer Time not set.  
L747 needs to be re-programmed

JP1 and JP2 jumpers fitted in parallel mode.  
DPU414 DIL Switches set incorrectly

Excessive Capacitance on Network

Incorrect cable connections – Use L747SL lead only.  
L747 DIL switches set incorrectly.  
JP1 jumper must be fitted for serial I/O.  
RS232 Baud rate can be 1200bps or 2400bps only (DIL SWITCH 7)  
RS232 format is only: 8 data bits, 1 stop bit, no parity.

All L747 DIL Switches must be [OFF] for this mode.  
DPU414 DIL switches must be set to Parallel Data Input.  
JP1 and JP2 jumpers should be removed.  
The Printer must be powered up and on line.  
Use standard parallel printer data lead to connect L747 to DPU414.

JP1 and JP2 jumpers must be fitted  
The Scope Kit must be powered up with the red led on and the green led off.  
You may use the **LIMKIT 747set** PC utility software to change the pager id  
Use **L747SL** RS232 Scope data lead (supplied by Intercall) to connect Scope kit to L747  
Use L747 – Null Modem data lead (see page 74)

### **CURE**

See page 38

See DPU414 manual page 17

Press BST/GMT button See page 38

Use **747set.exe** utility See page 38 and 74

See page 38

See DPU414 manual page 17

See *capacitance faults* on page 79

See page 38.

## FAULT

### Capacitance Faults (Data Corruption)

- F32. Emergency calls don't say "EMERGENCY!" on bottom line
- F33. Wrong type of call displayed (Assistance shows as normal call)
- F34. Call type changing (Bleep changes from assist to call with only 1 call up)
- F35. Printer printing several 'lost' then 'reset' devices
- F36. Pager (Alphanumeric) beeping with lost devices.
- F37. Calls cannot be accepted. (Display 'Lock's up')
- F38. Q' or 'q' appears on display when call(s) accepted
- F39. Calls come and go on the LCD display

### Volt Drop Faults (Low Network Volts)

- F40. LCD Beeper faint/ display keeps resetting (See Fault F11)
- F41. Call points reset spuriously.

### Audio Faults

**It is very important to be sure that the system is fully functional and that all digital features are working correctly before attempting to locate and rectify audio faults.**

- F42. Speech dropping out after a few seconds.
- F43. One way speech to or from call point.
- F44. One way speech to or from display.
- F45. Feedback between call point & display.
  
- F46. Buzzing on audio channel when open

## CAUSE

Network cable cores 'Doubled up' – see page 17  
Damp Network cables or unit(s)  
Booster unit required  
Two Call Points with the same address – see page 71  
Damaged Network Cable.

Excessive cable runs. – see page 17  
Short down long cable run.

Capacitance on Network cabling.  
Faulty unit – try substitution with another call point or display.  
Two call points set to the same address.  
Gain control set too high.  
Call Point and display too close or 'back to back' on a stud partition.  
Connection between Digital [+/-] and Audio [a/b]  
Belden cable not used as recommended  
Cable damage  
Damp or wet Network Cable  
Faulty Audio Unit  
Poor Connection.