

# Insulating gas density monitoring

Proven expertise for the power grids industry



## Global manufactures trust in Trafag

Gas-insulated switchgear, circuit breakers, transmission lines, transformers etc.

**Hitachi Energy (former ABB)**

**GE Grid Solutions**

**Hyundai Electric**

**Mitsubishi Electric**

**Siemens Energy**

**Hyosung Heavy Industries**

**Toshiba Energy Systems**

**Iljin Electric**

# Index

Trafag - the high-tech sensor company	5
Dedicated quality and production standards	7
Product portfolio history	8
Challenges and impacts on gas density monitoring	10
Product range overview	12
Operating principles	14
Gas density monitors	20
Gas density sensors	22
Hybrid gas density monitors	24
Accessories for demanding conditions	26





# Trafag – the hightech sensor company

Trafag, a Swiss-based company founded in 1942, is supported by a broad sales and service network in over 40 countries across the world. This allows Trafag to offer customers personalised and competent advice and ensures the best possible service. High-performance development and production departments not only guarantee the fast and reliable delivery of our high-quality and high-precision products, but also ensure that customisations can be implemented in a short time.

## Density monitoring solutions with maximum accuracy

Trafag stands for precise, robust and maintenance-free instruments, developed for the monitoring of SF<sub>6</sub> and alternative insulating gases in the field of high- and medium-voltage switchgear. Trafag guarantees outstandingly accurate, highly shock resistant instruments that operate in the widest temperature range on the market.

## Competent and customer-oriented

Technological competence, manufacturing expertise and customer-orientation form the three cornerstones of Trafag as a company. Trafag is a completely independent company with headquarters in Bubikon, Switzerland, and further manufacturing companies in Germany, Czech Republic and India. A fifth of its employees are involved in the fields of research and development, production technology or applications engineering.

## Application and solution-oriented

The direct availability of these resources enables Trafag to be extremely flexible in the areas of development and production as well as in its perception and implementation of customer requirements. Thanks to modular engineering, Trafag can efficiently adapt its standard products to the specific needs of customers.

## Market-oriented and always within reach

Trafag maintains an active presence in over 40 countries. A great number of customers in diverse industrial sectors such as high voltage technology, mechanical engineering, hydraulics, engine manufacturing, shipbuilding or railway technology appreciate the cooperation offered by our technically competent customer advisory service.

## Adaptable and efficient

The ability to develop and manufacture its strategically important components in-house means that Trafag can both mass-produce and manufacture on a small scale at short notice. Rigorous quality management in accordance with ISO 9001, state of the art production facilities under clean room conditions and stringently monitored production processes ensure that Trafag products meet the highest quality demands.



Gas-insulated switchgear (GIS) 400 kV, Qatar 2009 © Hitachi Energy

# Trafag's dedicated expertise

## Highest quality standards coupled with automated production process

### Pre-sales application and configuration support

Technical experts help to find the most suitable product for the specific application.

### Automated manufacturing process

A well harmonized automation standard complemented with manual operations by highly skilled personnel is the basis for the leading quality and performance. Trafag density monitors and sensors are produced under increased purity requirements and then are thoroughly tested. The devices leave the factory with a test certificate that the customers can access at any time.

### After-sales support

Trafag provides true end-to-end service and advice throughout the product life cycle. Many business relationships exist since decades.

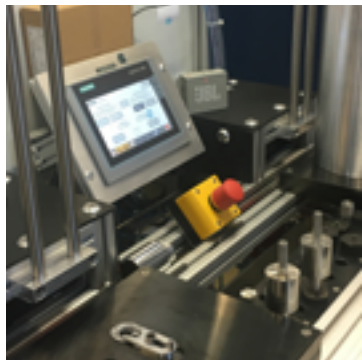

# Product portfolio history

## Trafag has more than four decades experience in gas density monitoring

The development of a temperature compensated pressure switch in 1978 marked the beginning of the era of Trafag's density portfolio. An ingenious combination of a pressure switch with thermostat components made it possible to enter the density monitoring market of SF<sub>6</sub> insulation gas in high-voltage switchgear. In 1987 Trafag developed the pioneering gas density monitor with reference gas chamber, a product with unsurpassed accuracy, vibration resistance and durability to this day. A metal bellows system plays the central role in this mechanical product. In 1994, Trafag bridged the gap of continuous gas density measurement and introduced the first electronic density sensor.

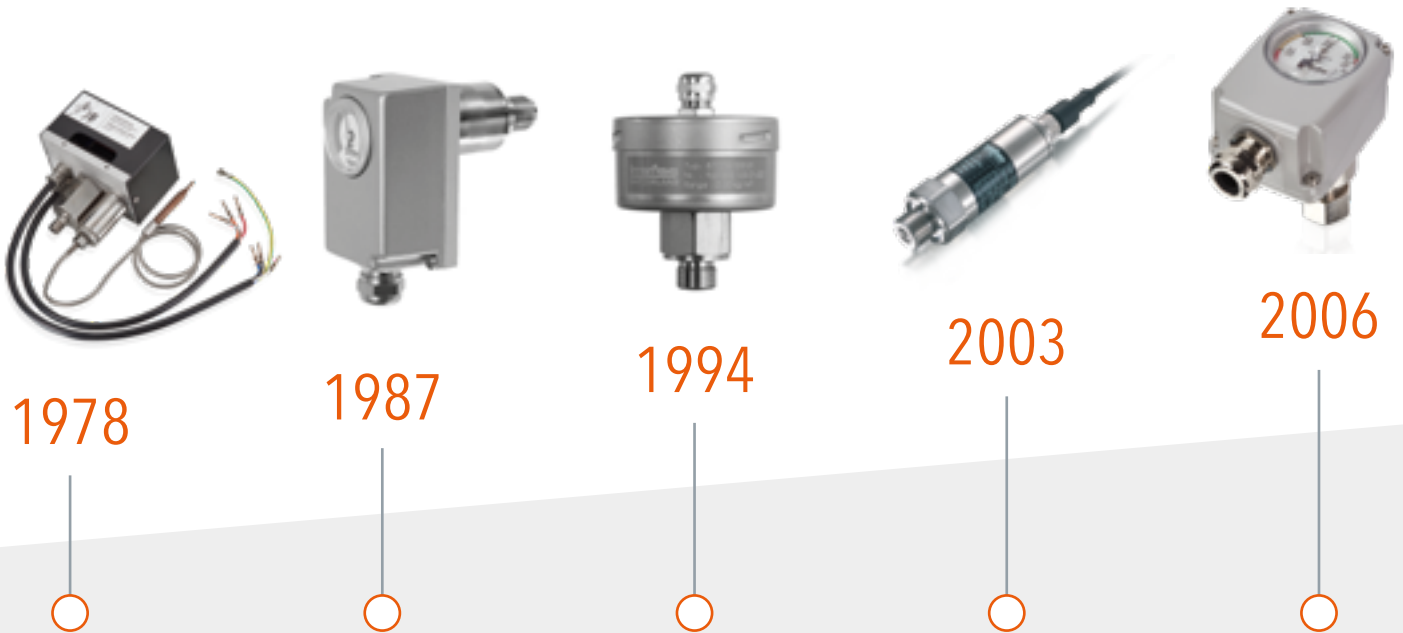

Trafag introduces the first density monitor with pressure switches for the international market.

Invention of the reference chamber principle that has become industry standard and introduction of density monitor type 87x0 with up to 3 microswitches.



Invention of the oscillating quartz sensing element and introduction of the first electronic density sensor.

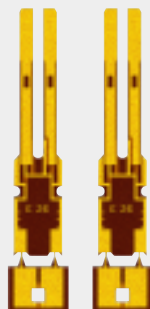

Introduction of 8774 density sensor with current loop output. Later the portfolio was extended with 8775 type with digital RS485/Modbus output.

Introduction of density monitor type 87x6 with up to 4 microswitches. In the meantime, portfolio was extended with 87x8 type for use in arctic climate zones.





2008



2010



2014



2017



2020

Introduction of 90° (radial) process connection and the low-pressure indication dial.

Introduction of the hybrid density monitor type 878x (current loop output) and 879x (RS484/Modbus output) that provides switchpoint monitoring and continuous density measurement in one device.



Introduction of density monitor type 87x7 with up to 3 microswitches.

Introduction of the integrated density monitor test valve.



Introduction of the integrated insulating gas test and re-filling valve.

# High-voltage power grid applications for gas density measuring and monitoring

## Challenges and impacts for maximum safety and accuracy

Most current conduction parts of high voltage switchgear, circuit breakers and transmission lines are mounted in pressure compartments filled with efficient insulation gases. Sulphur hexafluoride ( $\text{SF}_6$ ) gas is commonly used. Alternative insulation-gas mixtures, that are less harmful to the climate, steadily grow in market share. The insulation strengths of these gases depend basically on the gas density. As the dielectric strength capability of gas-insulated systems is obtained by the gas density, these compartments are filled to several hundred kPa pressure to prevent internal arcing and short circuits even over short distance.

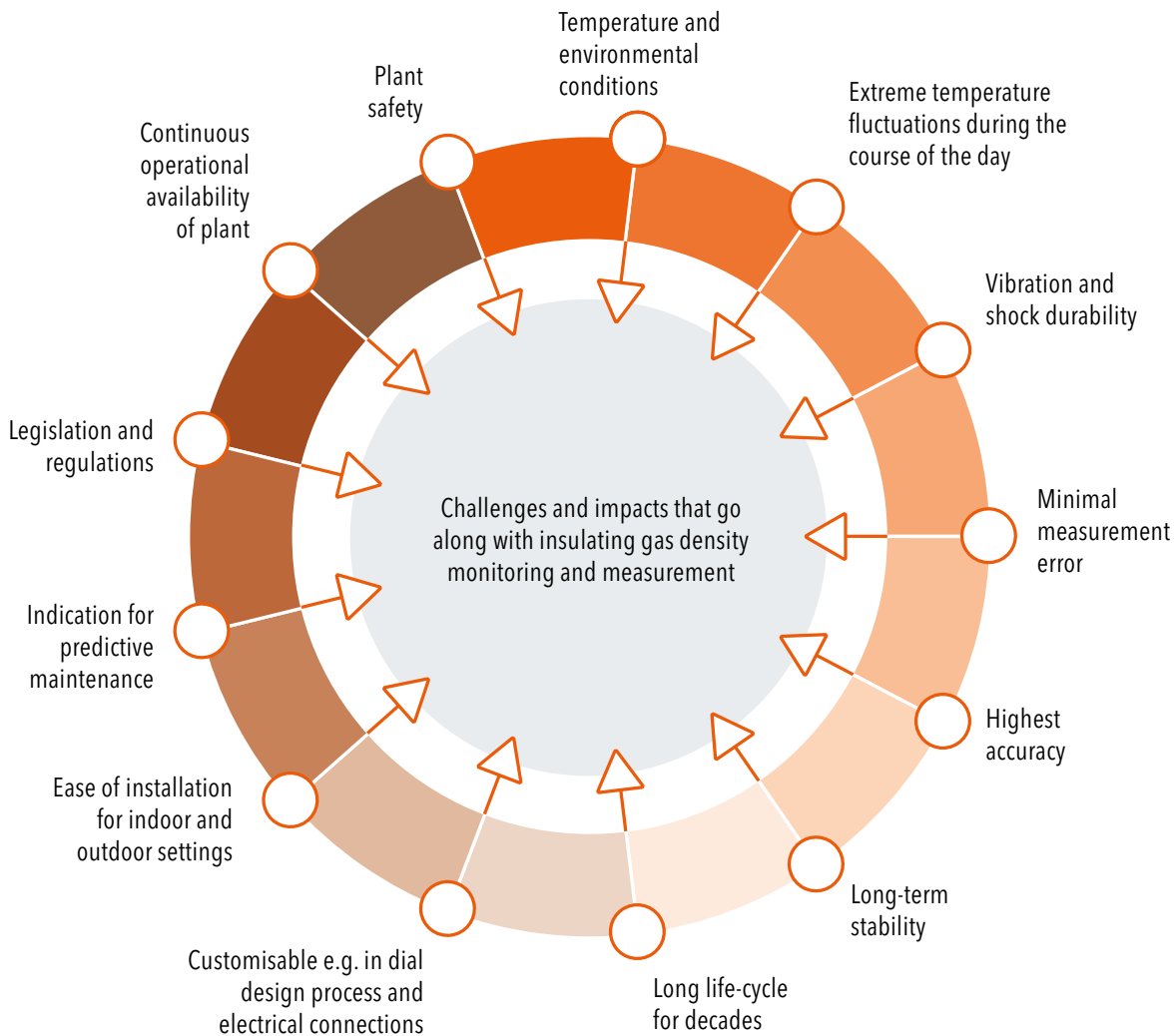

## Gas density monitoring plays a key role in plant availability and safety

The operational reliability and safety of high-voltage gear is only guaranteed when the appropriate level of gas density is maintained within the compartments. Leakage would compromise the safety of the switchgear and violate environmental regulations. SF<sub>6</sub> is a strong greenhouse gas and must therefore not leak into the environment. Strict regulations regarding SF<sub>6</sub> emissions (e.g. F-gas Regulation 517/2014) must be met and stipulate a permanent monitoring of gas leakage. This is done with gas density monitors or gas sensors to trigger safety-related alarms or switching processes and to transmit the status to a data network.

Therefore, continuous density measurement adds several advantages to monitoring of safety alarm trigger points. Real time data allows analysis of the operational availability of the plant and the implementation of inspection windows or predictive maintenance measures.

## Highest environmental resistance required

Gas-insulated systems are often installed outdoors. Temperatures between -40°C and +50°C are quite common. In arctic climate zones even temperatures down to -60°C are imposed on the equipment. In addition massive temperature fluctuations, even between day and night, plant shock and vibration have an impact on density monitor and related accessories. However, a long life cycle of density monitoring equipment for several decades is required.

## Superior gas density reference chamber and quartz tuning fork principle

Gas density is often indirectly determined by the gas pressure using manometers or pressure sensors. As the pressure in a hermetically closed volume varies enormously with temperature, such devices need temperature compensation, resulting in a source of error. Trafag provides two leading technologies for direct monitoring and measuring of insulating gas density offering the most reliable solutions on the market. Mechanical monitors determine the gas density directly by the reference chamber principle. Gas density sensors employ the electronic quartz tuning fork technology to measure density directly. Both technologies are combined in Trafag's hybrid density monitors.

---

## Typical applications for SF<sub>6</sub> and alternative insulating gas monitoring

- Gas-insulated switchgear (GIS) and switching stations
  - Circuit breakers (generator, live and dead tank)
  - Gas insulated transmission lines (GIL)
  - Gas insulated transformers (GIT)
- 



# Product range overview

## Monitoring and measurement devices

Trafag's product range of gas density measuring devices splits into three different product groups: The mechanically working Gas Density Monitor, the electronic Gas Density Sensor and the Hybrid Gas Density Monitor, monitoring both mechanically and electronically. All three types have one thing in common: They are suitable for SF<sub>6</sub> and the complete range of alternative insulating gases.

### Gas Density Monitors

#### Absolute SF<sub>6</sub> and alternative gas density monitoring with reference gas comparison

The Gas Density Monitor is based on the principle of reference gas comparison and therefore no temperature compensation is necessary. It works electromechanically and is thus independent of electrical energy supply. Since no recalibration of switchpoints is needed, it operates maintenance-free. The operating temperature ranges are from -60°C up to +80°C.

- Type 87x6 mechanical, self-acting see page 20
- Type 87x8 for arctic environments see page 21



### Gas Density Sensors

#### Electronic absolute SF<sub>6</sub> and alternative gas density measurement with patented quartz tuning fork

The Gas Density Sensor uses a quartz tuning fork to measure gas density directly – a unique technology patented by Trafag. With the delivery of continuous output signals (analogue or digital) from this electronically operating sensor, Trafag opens new paths for the energy distribution industry. Comprehensive density trend analysis of pressurized compartments is implemented easily.

- Type 8774 with current loop or pulse-width modulation output see page 22
- Type 8775 with digital RS485/Modbus output see page 23



### Hybrid Gas Density Monitors

#### Combined mechanical monitoring and electronic measurement of SF<sub>6</sub> and alternative gas density

The Hybrid Gas Density Monitor combines the advantages of both, the mechanical gas density monitor and the electronic gas density sensor in a compact all-in-one apparatus. With its continuous measurement output it is ideal for insulating gas management trending systems, but it also has a local gas pressure indication and robust switchpoint alarm contacts.

- Type 878x with current loop output see page 24
- Type 879x with digital RS485/Modbus output see page 25



Note: The monitor type x-designation (e.g. 87x6) stands for individual microswitch configuration. For example, monitor type 8736 contains x = three (3) microswitches.

With the kind support of Swiss Grid



# Operating principles

## Gas density monitoring with reference gas comparison

The reference gas comparison principle was invented by Trafag in mid 1980s and was continually improved. Today it is the leading industry standard for temperature compensated insulating gas density monitoring in applications with high demand for reliability, accuracy, stability and longevity.

### Necessity for temperature independent density monitoring

Density measurement in pressurised, gas-insulated compartments is all about physics. Pressure, density and temperature are in a certain relationship to each other. The relationship is defined by isochores (constant-volume process) for each specific insulating gas. The insulating performance of a gas-insulated compartment is achieved through a defined density which results into a certain pressure at a given temperature. In a closed and tight compartment, the overall density always remains constant, but temperature variations lead to a variation of the system pressure.

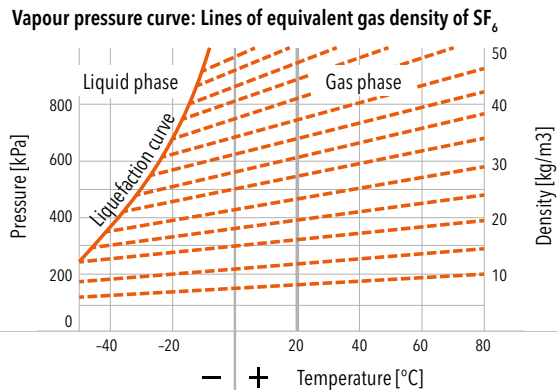

Lines exemplary representing constant SF<sub>6</sub> gas density (isochores): Changes in pressure and temperature with constant volume.

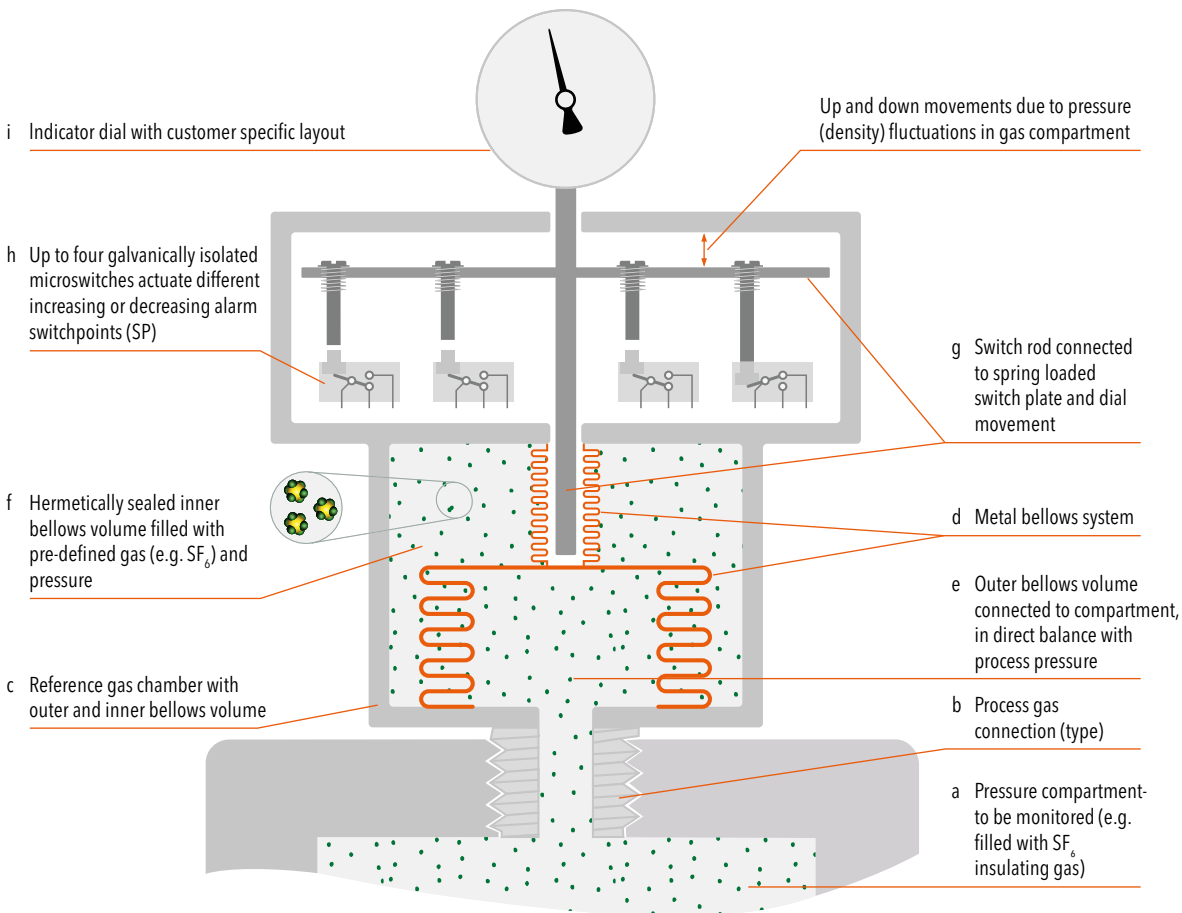

### **Absolute monitoring principle (temperature compensated due to reference principle)**

A density monitor is typically directly mounted to the pressure compartment of the high-voltage equipment (a) via a customizable process connection (b).

Trafag density monitors are based on a reference chamber (c) incorporating a metal bellows system (d), which is pre-pressurized with the customer specific insulating gas. The metal bellows system allows a direct temperature coupling of pressure compartment gas and gas filling in the reference chamber. Ambient temperature changes affect the pressure (isochoric change) in the gas compartment to the same extent as they affect the pressure in the reference chamber.

Therefore, the effect of temperature on insulating gas pressure is inherently compensated and a very precise insulating gas pressure @ 20°C (equalling the density), at any temperature, is indicated on a dial face (i). No false alarm is triggered due to temperature-induced pressure changes.

Reference gas chamber and pressure compartment are both hermetically sealed systems. Ambient pressure has no influence on the operating principle. Therefore, it is an absolute monitoring principle.

---

### **Practical example:**

Filling pressure (density) of insulating gas compartment: 6.1 bar abs. @ 20°C, pure SF<sub>6</sub>

---

SP1: 5.7 bar abs. @ 20°C, decreasing warning switchpoint for compartment re-filling

---

SP2: 5.5 bar abs. @ 20°C, decreasing lock-out alarm switchpoint

---

SP3: 5.5 bar abs. @ 20°C, redundant decreasing lock-out alarm switchpoint

---

SP4: 6.4 bar abs. @ 20°C, increasing high-alarm switchpoint for compartment overpressure

---

Factory pre-pressurised inner bellows volume of reference chamber: 5.7 bar abs. @ 20°C, SF<sub>6</sub>, hermetically sealed, according to SP1

---

### **Bellows system actuates microswitches**

The pressure, more specifically the density of the insulating gas compartment is compared via the outer bellows volume (e) with the pre-defined density of the hermetically sealed inner bellows volume (f) of the reference chamber. If the density of the gas compartment alters, the bellows system actuates via a switch rod and a spring-loaded switch plate (g) up to four independent microswitches (h). Each microswitch can be factory-calibrated either to increasing or decreasing pressure alarm.

That means when the density drops below pre-defined switchpoint (SP) settings, the microswitch contacts gradually close or open. The switchpoint accuracy is factory tested at -25°C, +20°C and 50°C.

### **Supporting measures for demanding outdoor applications**

If the local, environmental effects hamper a direct temperature coupling of pressure compartment (a) and reference gas chamber (c), e.g. outdoor installation with diurnal solar radiation or rapidly changing or extreme weather conditions, specifically designed thermal covers maintain the necessary equality between pressure compartment and reference gas chamber.

If the insulating gas compartment pressure (a,e) drops due to leakage, the hermetically sealed inner bellows volume pressure (f) gains impact towards the dropping compartment pressure. Switch rod with switch plate (g) move down.

While the pressure drops below switchpoint 1 (SP1) at 5.7 bar abs. @ 20°C, the first microswitch changes over and induces first-alarm. Usually, the first-alarm indicates that the pressure compartment must be re-filled.

If the pressure drops further, in the example below 5.5 bar abs. @ 20°C, then usually two more, redundant microswitches change over (SP2 and SP3). By default, these switchpoints are used as emergency stop; the operational safety of the system is no longer guaranteed. A fourth microswitch (SP4) e.g. can be used to monitor undesired overpressure conditions during re-filling routines of the pressure compartment. If the pressure rises above 6.4 bar abs. @ 20°C, the microswitch changes over and induces high-alarm.

---

### **Reference gas comparison is deployed in the following Trafag devices:**

- Gas density monitors 87x6 and 87x8
- Hybrid gas density monitors 878x and 879x

see page 20, 21  
see page 24, 25

# Operating principles

## Electronic absolute gas density measurement with quartz tuning fork

Trafag introduced the quartz tuning fork density measurement technology in the mid 1990s. It is the choice where continuous and long-term drift free density measurement and data acquisition is required. The tuning fork technology is commonly known from its use as the timefrequency standard in clocks. Exposing an oscillating tuning fork to gases of different density lead to a shift and a damping of its resonance frequency. It is a direct density measurement principle.

The density sensor is mounted to the pressure compartment (a) via a customizable process connection (b). Thus, density in the insulating gas compartment and the sensor measurement chamber (c) is in balance. Trafag density sensors use the physics by comparing the constant resonant frequency of a quartz oscillator under vacuum (d) with the resonant frequency of an identical quartz surrounded by the insulating process gas (e).

Gas of different density affects the pre-set resonant frequency of the process gas surrounded quartz tuning fork. The response time for the detection of density changes is less than 10ms. The shift of the resonant frequency is proportional to the density of the insulating process gas. The digital processing unit features an additional temperature sensor (f). The measurement signal is provided on selectable outlet connectors (g).

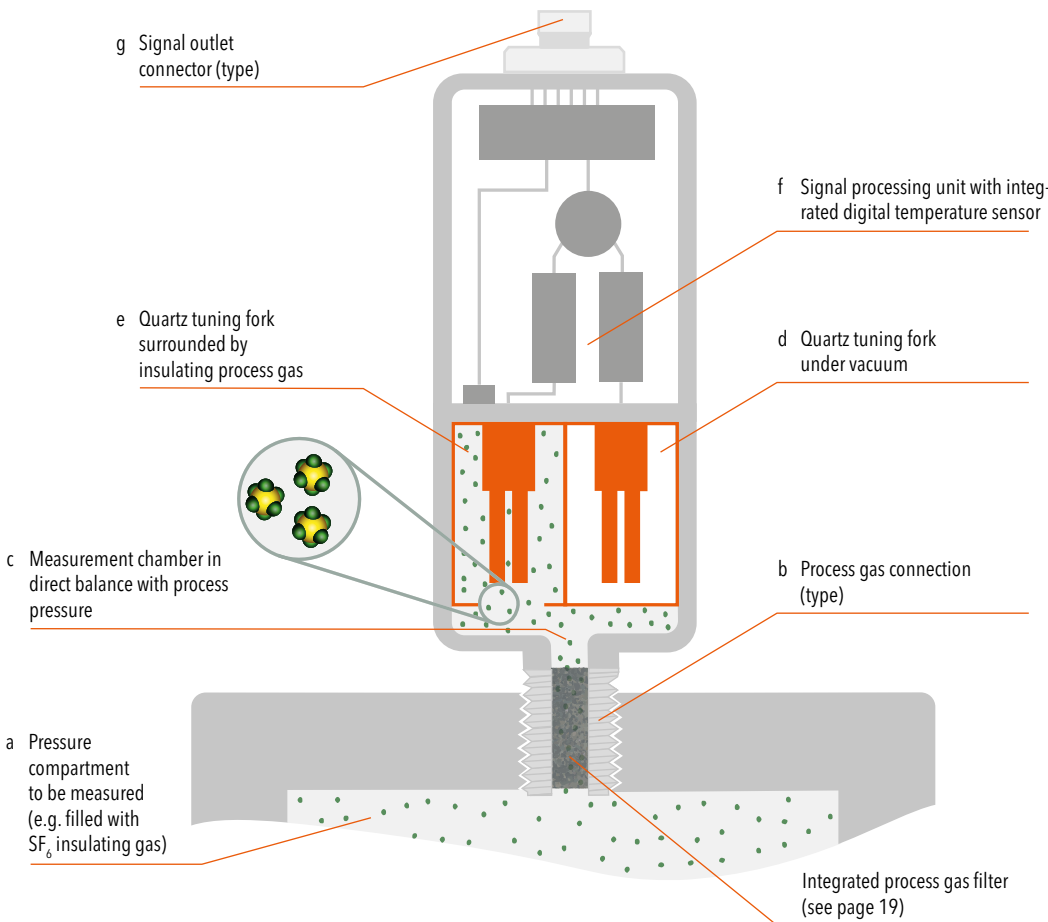

### Electronic gas density measurement with quartz tuning fork is deployed in the following Trafag devices:

- Gas density sensors 8774 and 8775 see page 22, 23
- Hybrid gas density monitors 878x and 879x see page 24, 25



With kind support of TransnetBW GmbH





With the kind support of Swiss Grid

# Operating principles

## Countermeasures against aggressive SF<sub>6</sub> by-products

SF<sub>6</sub> is inert during normal use. When electrical discharges occur within SF<sub>6</sub> filled gas compartments, mechanical abrasion, toxic and material-aggressive by-products can emerge. The two main by-products that may occur are hydrofluoric acid and thionyl fluoride. Both can cause long-term damage to improper material selection. Abrasion particles can cause sensing element degradation. Trafag deals with it by using suitable materials and additional integrated process gas filters.

### Countermeasures for devices with reference gas comparison

Materials for process gas connection, reference gas chamber and bellows system are specifically selected to withstand hydrofluoric acid and thionyl fluoride. High-alloyed stainless steels 1.4404, 1.4435, 1.4571 (AISI316L, AISI316Ti) are used.

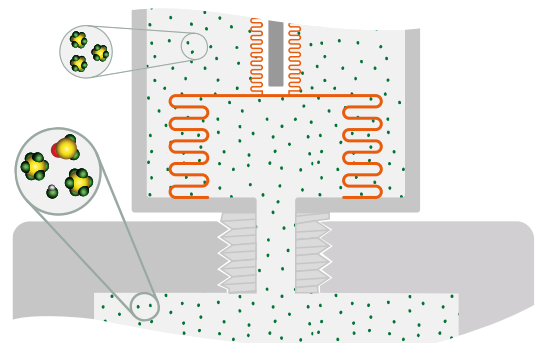

Reference gas chamber, bellows system and process connection are made of stainless steel.

### Countermeasures for devices with quartz tuning fork technology

The quartz tuning fork requires advanced countermeasures to repel ingress of aggressive by-products that may occur in insulating gases. Materials for the process gas connection and measurement chamber are specifically selected. High-alloyed stainless steels 1.4404 and 1.4435 (AISI316L) are used. An additional integrated process gas filter protects from fine abrasion particles and absorbs corrosive gases.

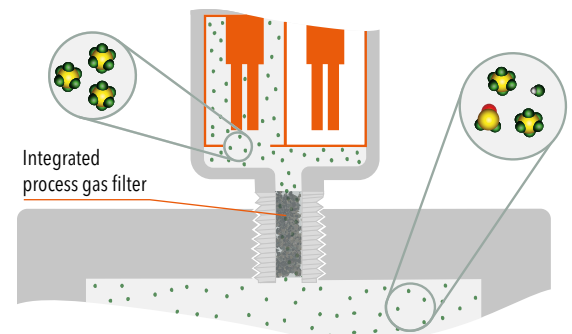

Measurement chamber and process connection are made of stainless steel. A process gas filter protects from aggressive by-products.

### Response time of the integrated process gas filter of the density sensor

During normal operation, insulating gas density changes are detected in less than 10 ms. The integrated filter element induces a transient response time after installation and initial insulating gas filling. Therefore, a minimised time period for gas equalization between process compartment and the sensor's measurement chamber occurs.

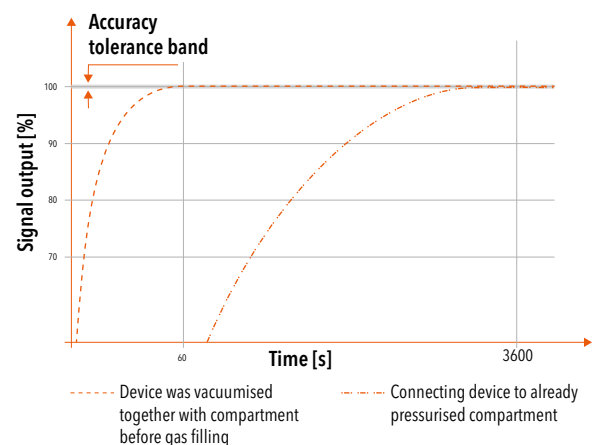

Transient initial response time which is required after installation and gas filling for the sensor signal output to reach accuracy tolerance band.

# Gas Density Monitor 87x6

## Density monitoring with highest switchpoint accuracy in harsh environments

The mechanical, self-acting gas density monitor 87x6 is based on the superior reference gas principle which is temperature compensated by design. It therefore meets standards of demanding applications over a wide temperature range. Today's full range of insulating gas mixtures can be monitored. This precise and maintenance-free density monitor is equipped with high-performance microswitches and is reliable in operation over decades for indoor and outdoor applications.



### Technical Data

Monitoring principle	Absolute pressure measuring system with sealed reference gas chamber, fully temperature compensated by design
Monitoring range	0 ... 1100 kPa abs. @ 20°C
Monitoring output	Floating change-over contact (SPDT)
Quantity of switchpoints	1 ... 4 microswitches
Switchpoint accuracy @ 20°C	± 8 kPa max.
Ambient temperature	-40°C ... +80°C
Protection	IP65 and IP67

### Features

- For SF<sub>6</sub> and variety of alternative mixed gases
- Exact switching output at all temperatures
- No contact bouncing, high shock and vibration stability
- Indoor and outdoor use
- Maintenance free

Data sheet [www.trafag.com/H72511](http://www.trafag.com/H72511)  
 Process connections [www.trafag.com/H72502](http://www.trafag.com/H72502)  
 Instructions [www.trafag.com/H73511](http://www.trafag.com/H73511)

Trafag provides maximum flexibility in customization for the indicator dial with a full variety of colour codings and pressure units including dual range indication. This also includes rotated dial orientation by 90°/180°/270° to provide best readability for restricted installations.

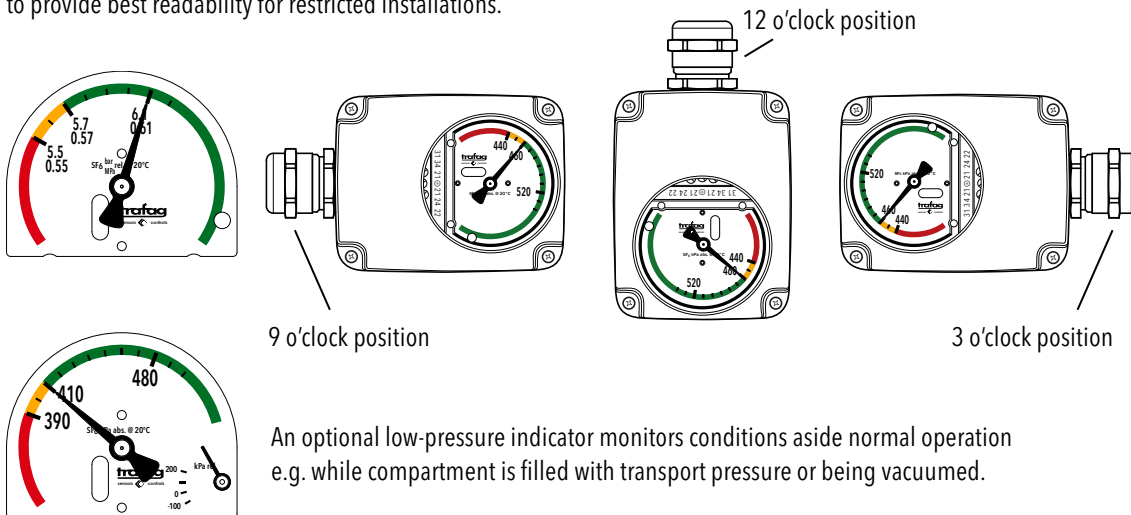

# Gas Density Monitor 87x8

## Density monitoring for demanding arctic climate zones

Gas density monitor 87x8 allows to monitor the full range of insulating gas mixtures in demanding arctic climate zones and is equipped with up to four high-performance microswitches. The reference chamber is temperature compensated by design and induces an alarm switching signal in the event of insulating gas liquefaction due to extremely low temperatures. This precise and maintenance-free monitor is reliable in operation over decades.



### Technical Data

Monitoring principle	Absolute pressure measuring system with sealed reference gas chamber, fully temperature compensated by design
Monitoring range	0 ... 1100 kPa abs. @ 20°C
Monitoring output	Floating change-over contact (SPDT)
Quantity of switchpoints	1 ... 4 microswitches
Switchpoint accuracy @ 20°C	± 8 kPa max.
Ambient temperature	-60°C ... +80°C
Protection	IP65 and IP67

### Features

- Exact switching output for arctic climates
- Switching signal in case of liquefaction
- For SF<sub>6</sub> and variety of alternative mixed gases
- No contact bouncing, high shock and vibration stability
- Maintenance free

Data sheet	<a href="http://www.trafag.com/H72513">www.trafag.com/H72513</a>
Process connections	<a href="http://www.trafag.com/H72502">www.trafag.com/H72502</a>
Instructions	<a href="http://www.trafag.com/H73513">www.trafag.com/H73513</a>

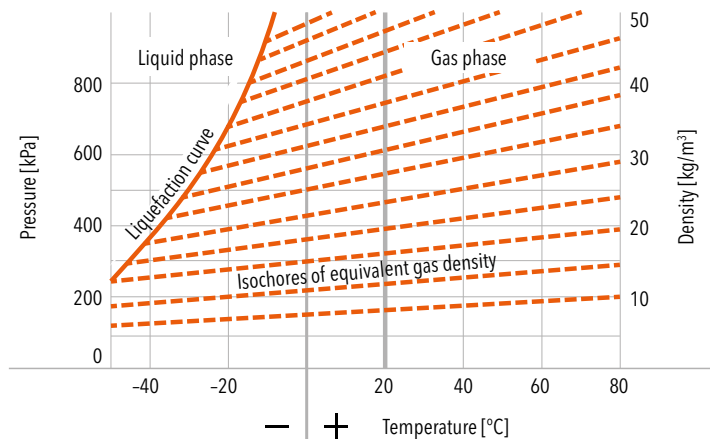

Arctic climate presents the highest requirements to gas compartment and density monitoring. The main safety aspect is the alarm when the insulating gas may liquefy.

Low temperatures can lead to liquefaction of process gas. Liquefaction causes a rapid pressure-drop that can temporarily trigger an alarm switchpoint. Gas density monitor 87x8 keeps the alarm status until the alarm trigger level is exceeded again while returning to normal condition.

# Gas Density Sensor 8774

## Continuous density measurement with current loop or pulse-width modulation output

The sensor type 8774 is specifically designed for density measuring of insulation gases. This unique patented sensor technology enables the energy distributing industry to realize comprehensive trend analysis and data acquisition in gas insulated pressure compartments. It measures directly and continuously the gas density providing an analogue current or digital pulse-width output signal. Trend analysis helps to detect possible leakages sooner, provides data for preventive maintenance measures and therefore facilitates compliance with greenhouse gas regulations.



### Technical Data

Measuring principle	Oscillating quartz sensor
Measuring range	0 ... 56.1 kg/m <sup>3</sup> or 0... 60kg/m <sup>3</sup> 0 ... 1100 kPa abs. @ 20°C
Sensor output	6.5... 20mA current loop or digital pulse-width modulation with density and temperature output signal
Measuring accuracy	± 1.0 % FS typ.
Ambient temperature	-40°C ... +80°C
Protection	IP65 and IP67

Data sheet  
Instructions

[www.trafag.com/H72507](http://www.trafag.com/H72507)  
[www.trafag.com/H73507](http://www.trafag.com/H73507)

### Features

- Continuous measurement of SF<sub>6</sub> and alternative gas density
- Current loop output
- Optional pulse-width modulation output
- Long term drift free output signal
- Outdoor applications without additional protection
- Maintenance free

The digital pulse-width modulation features density and temperature data. Trafag provides conversion formulas for gas density, standardised gas pressure @ 20°C for SF<sub>6</sub> or alternative insulating gases and for the conversion of pulse-width to temperature.

SF<sub>6</sub> gas density: pulse sequence signal

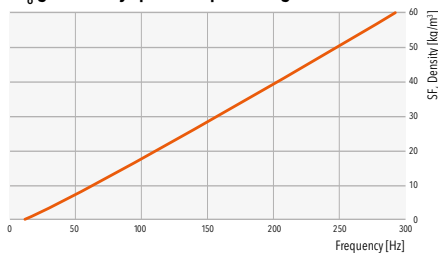

Digital current pulses

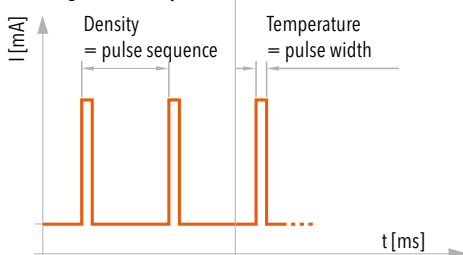

SF<sub>6</sub> gas density: current loop output

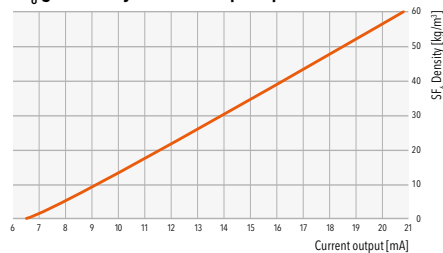

The current loop output has a resolution of 6.5 ... 20 mA. Trafag provides conversion formulas for gas density and standardised gas pressure @ 20°C for SF<sub>6</sub> and alternative insulating gases.

# Gas Density Sensor 8775

## Continuous density measurement with digital RS485/Modbus output

The digital sensor type 8775 is specifically designed for density measuring of insulation gases. It is aimed to be integrated into Modbus sensor networks. This unique patented sensor technology enables the power industry to realize comprehensive trend analysis and data acquisition, which helps to detect possible leakages sooner, provides data for preventive maintenance measures and therefore facilitates compliance with greenhouse gas regulations.



### Technical Data

Measuring principle	Oscillating quartz sensor
Measuring range	0... 60kg/m <sup>3</sup> 0... 1100 kPa abs. @ 20°C
Sensor output	Gas density [kg/m <sup>3</sup> ], gas pressure [kPa abs.] @ 20°C, gas temperature [K], gas pressure [kPa abs.] @ temperature variable
Measuring accuracy	± 1.0 % FS typ.
Ambient temperature	-40°C ... +80°C
Protection	IP65 and IP67

### Features

- Continuous measurement of SF<sub>6</sub> and alternative gas density
- Digital RS485/Modbus (RTU) output
- Long term drift free output signal
- Outdoor applications without additional protection
- Maintenance free

Data sheet  
Instructions

[www.trafag.com/H72519](http://www.trafag.com/H72519)  
[www.trafag.com/H73519](http://www.trafag.com/H73519)

### Modbus communication setting

The open available Modbus protocol is the ideal communication layer for transmitting data between electronic devices over serial RS485 lines. It is a client/server protocol. One client controls the data transactions with multiple servers (sensors) that respond to the client's requests (read or write data). In a standard Modbus serial network, there is one client and up to 64 servers (sensors), each with a unique server address.

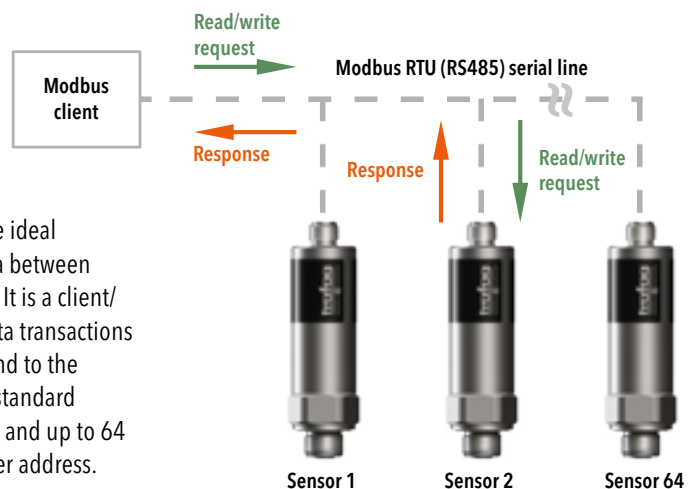

# Hybrid Gas Density Monitor 878x

## Combined density monitoring and measurement with current loop output

The hybrid gas density monitor combines self-acting monitoring with high-performance microswitches and continuous density measurement of insulating gases in one device. It covers demanding applications and maintains highest accuracy over a very wide temperature range. Trend analysis helps to detect possible leakages sooner, provides data for preventive maintenance measures and therefore facilitates compliance with greenhouse gas regulations. This precise and maintenance-free hybrid density monitor is reliable in operation over decades for indoor and outdoor applications.



### Features

- For SF<sub>6</sub> and variety of alternative mixed gases
- Exact switching output at all temperatures
- High shock and vibration stability
- Continuous measurement of gas density
- Current loop output
- Long term drift free output signal
- Maintenance free indoor and outdoor use

### Technical Data

Monitoring principle	Absolute pressure measuring system with sealed reference gas chamber, fully temperature compensated by design
Measuring principle	Oscillating quartz sensor
Monitoring range	0 ... 1100 kPa abs. @ 20°C
Measuring range	0 ... 56.1 kg/m <sup>3</sup> 0 ... 1100 kPa abs. @ 20°C
Output signal	Floating change-over contact (SPDT)
Quantity of switchpoints	1 ... 3 microswitches
Sensor output	6.5 ... 20 mA current loop
Switchpoint accuracy @ 20°C	± 8 kPa max..
Measuring accuracy	± 1.0 % FS typ.
Ambient temperature	-40°C ... +80°C
Protection	IP65 and IP67

Data sheet	<a href="http://www.trafag.com/H72511">www.trafag.com/H72511</a>
Process connections	<a href="http://www.trafag.com/H72502">www.trafag.com/H72502</a>
Instructions	<a href="http://www.trafag.com/H73511">www.trafag.com/H73511</a>

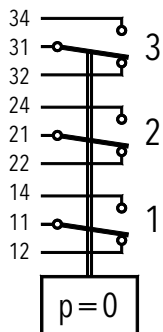

Density monitoring is based on up to three galvanically isolated microswitches that actuate different alarm signals.

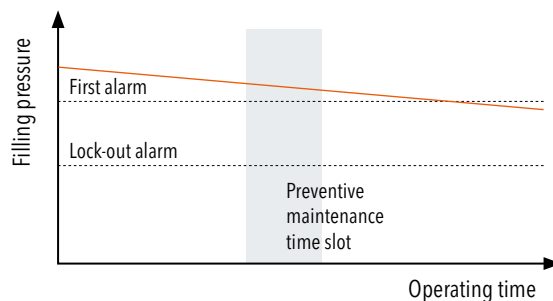

Density measurement is provided via 2-wire current loop output. It provides essential trend information of potential gas losses or gear status and therefore allows to determine preventive maintenance measures.



# Hybrid Gas Density Monitor 879x

## Combined density monitoring and measurement with digital RS485/Modbus output

The hybrid gas density monitor combines self-acting monitoring and continuous density measurement of insulating gases in one device. The digital RS485/Modbus output allows the parameterisation of gas density, gas pressure and gas temperature output data. Trend analysis helps to detect possible leakages sooner, provides data for preventive maintenance measures and therefore facilitates compliance with greenhouse gas regulations. This precise and maintenance-free hybrid density monitor is reliable in operation over decades for indoor and outdoor applications.



### Features

- For SF<sub>6</sub> and variety of alternative mixed gases
- Exact switching output at all temperatures
- High shock and vibration stability
- Continuous measurement of gas density
- Digital RS 485/Modbus (RTU) output
- Long term drift free output signal
- Maintenance free indoor and outdoor use

### Technical Data

Monitoring principle	Absolute pressure measuring system with sealed reference gas chamber, fully temperature compensated by design
Measuring principle	Oscillating quartz sensor
Monitoring range	0 ... 1100 kPa abs. @ 20°C
Measuring range	0 ... 60 kg / m <sup>3</sup> 0 ... 1100 kPa abs. @ 20°C
Output signal	Floating change-over contact (SPDT)
Quantity of switchpoints	1 ... 3 microswitches
Sensor output	Gas density [kg/m <sup>3</sup> ], gas pressure [kPa abs.] @ 20°C, gas temperature [K], gas pressure [kPa abs.] @ temperature variable
Switchpoint accuracy @ 20°C	± 8 kPa max..
Measuring accuracy	± 1.0 % FS typ.
Ambient temperature	-40°C ... +80°C
Protection	IP65 and IP67

Data sheet [www.trafag.com/H72517](http://www.trafag.com/H72517)  
 Process connections [www.trafag.com/H72502](http://www.trafag.com/H72502)  
 Instructions [www.trafag.com/H73520](http://www.trafag.com/H73520)

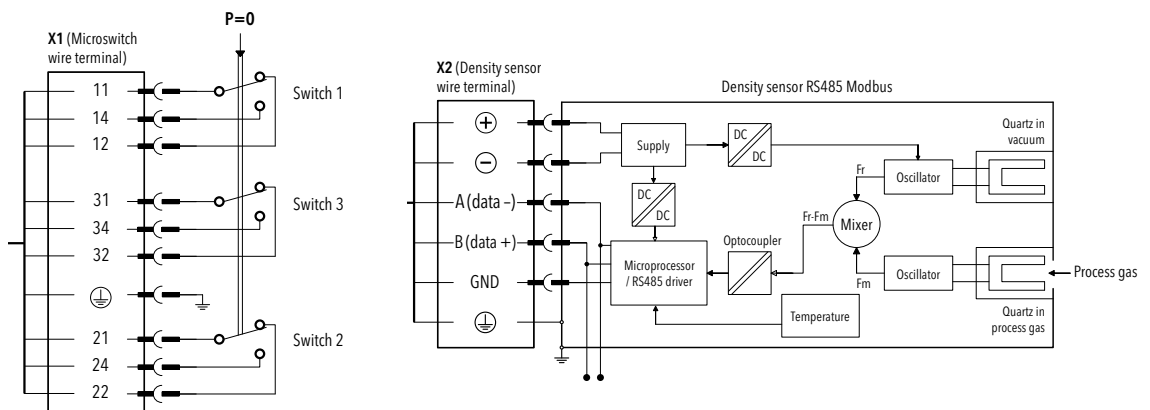

Density monitoring microswitches and sensor data signal are separated by independent wire terminals.

# Sheltering options

For demanding environmental conditions



## Weather protection cover with separate thermal insulation ring

The weather protection cover is aimed for long-term element protection of the density monitor. The insulation ring for the probe housing increases thermal inertia in moderately changing climates. The probe housing is the lower part of the monitor where the reference gas chamber and the oscillating quartz sensor are located.

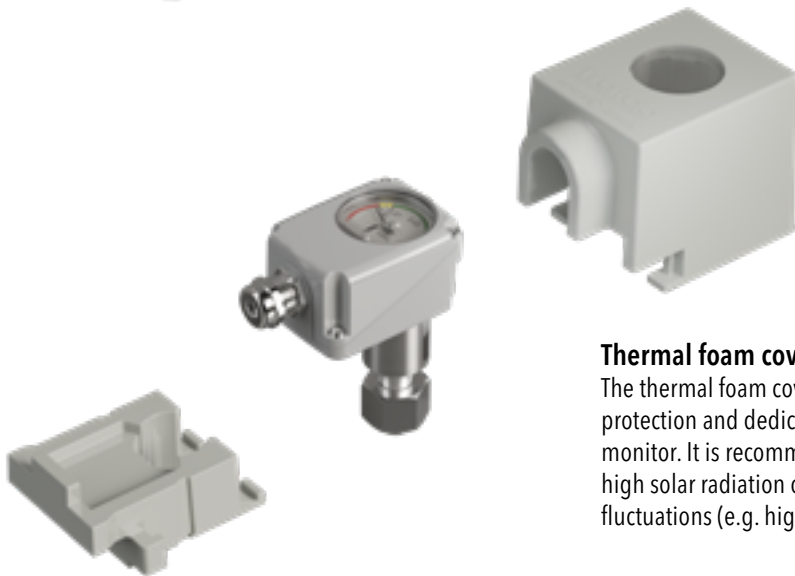

## Thermal foam cover

The thermal foam cover is aimed for long-term element protection and dedicated thermal inertia of the density monitor. It is recommended for outdoor installations with high solar radiation or extreme diurnal temperature fluctuations (e.g. high altitude, arctic, desert).

## Compartment immersion process connection

The compartment immersion is an intank pressure connection installation that is aimed to match continuously process gas and monitor probe temperature. This allows to further minimize a temperature disbalance between reference chamber and gas tank. A bayonet fitting with integrated stop valve allows installation while process compartment is pressurised.



# Valve options

For easy and safe handling

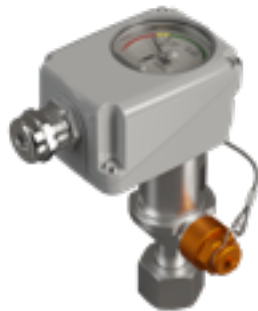

## Integrated density monitor test valve

Greenhouse regulations require regular verifications of the used equipment. The test valve allows in-situ microswitch point or sensor checkings without dismantling the monitor from the pressure compartment. Test equipment is connected via a standardised DN8 port during normal operation under nominal system pressure.

Normal operation

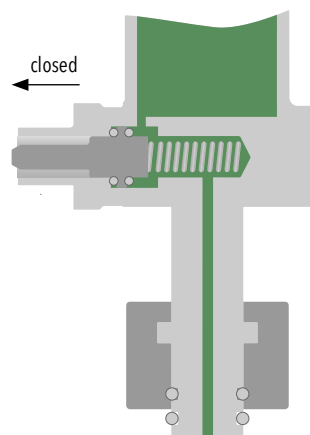

Monitor test mode

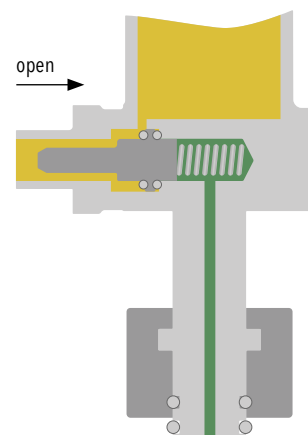

## Integrated process gas test and re-fill valve

The test and re-fill valve offers two essential functionalities. Firstly, it provides the capability to analyze in-situ the gas quality of the pressure compartment. On the other hand, it is a re-filling valve that allows direct insulating gas replenishment of the pressure compartment. Test or re-fill equipment is connected via a standardised DN8 port during normal operation under nominal system pressure.

Normal operation

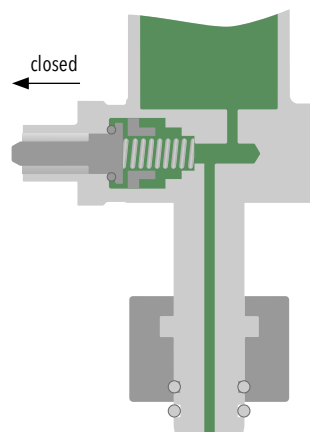

Process gas test and re-fill mode

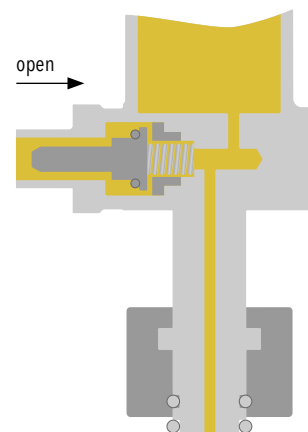



# Reliable quality

Worldwide represented, globally trusted, Swiss based

## Subsidiaries

Germany  
France  
Great Britain  
India  
Italy  
Japan  
Austria  
Poland (Joint Venture)  
Russia (Joint Venture)  
Switzerland (Headquarters)  
Spain  
Czech Republic  
USA

## Representatives

Albania	Denmark	Lithuania	Romania
Argentine Republic	Ecuador	Macedonia	Serbia
Australia	El Salvador	Malaysia	Singapore
Belgium	Estonia	Mexico	Slovakia
Bolivia	Finland	Montenegro	South Africa
Bosnia	Greece	Netherlands	Sweden
Brazil	Guatemala	New Zealand	Taiwan
Canada	Honduras	Nicaragua	Thailand
Chile	Hungary	Norway	Turkey
China	Iceland	Panama	Ukraine
Colombia	Indonesia	Paraguay	United Arab Emirates
Costa Rica	Israel	Peru	Uruguay
Croatia	Korea	Philippines	Vietnam
Cyprus	Latvia	Portugal	

Subject to change 11/2021 H70558a

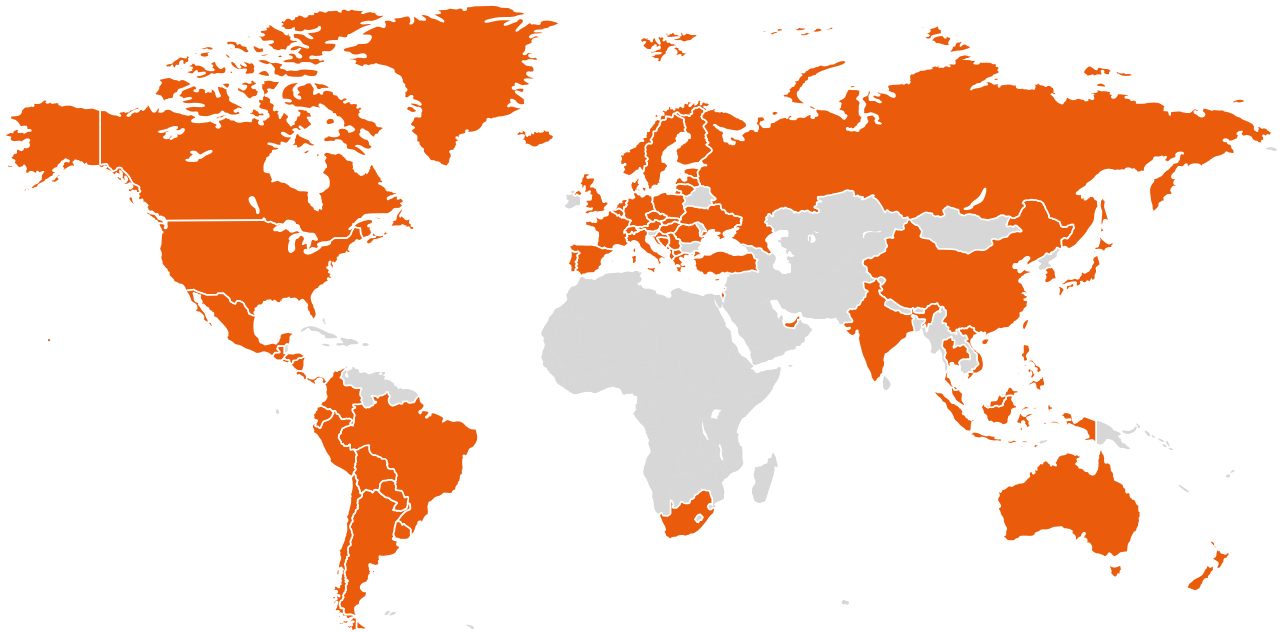

The coordinates to the representatives can be found at [www.trafag.com/trafag-worldwide](http://www.trafag.com/trafag-worldwide)