

wybone

Wyatt Bench



Call: 01226 744010

Web: www.wybone.co.uk

Email: sales@wybone.co.uk

The Wyatt Bench pays honour to the Wybone Founder, Charles E. Wyatt. An ambitious visionary, we've combined his passion for manufacturing with our in-house design experts to bring a refreshing, stylish and original bench design.

This bench is carefully crafted using galvanised steel and Iroko wood, making it stand out in historic and modern locations.

- The seating and backrest are made from Iroko wood. Only found in Africa, this exotic, stylish and durable wood is sourced from PEFC-accredited managed forests for sustainable solutions. So join us in going greener.
- Galvanised steel frame, legs and optional arm rests that are rust and corrosion resistant. Essential for benches in outdoor settings.
- Remove the stress of installation. Choose to have extended bench legs for concrete fixing or use RAWL bolts for ground fixing.
- Comes in 3 different wood finishes and multiple steel colours, including your own bespoke artwork.

1YR PARTS & LABOUR GUARANTEE

All of our products come with a 1 year parts and labour guarantee as standard.

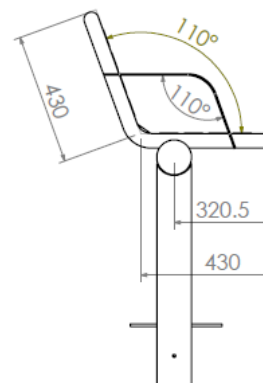
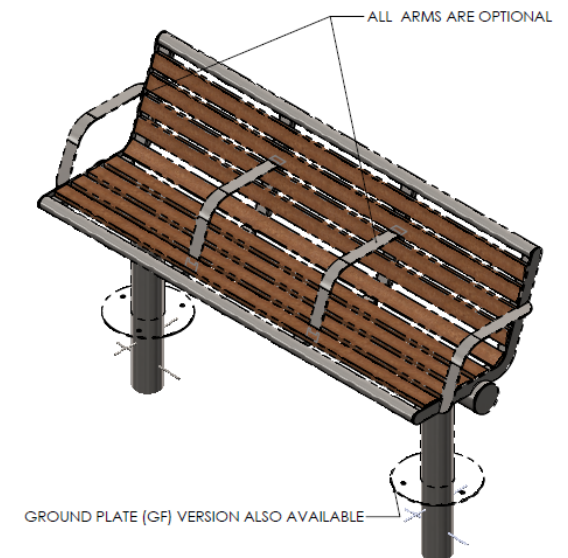
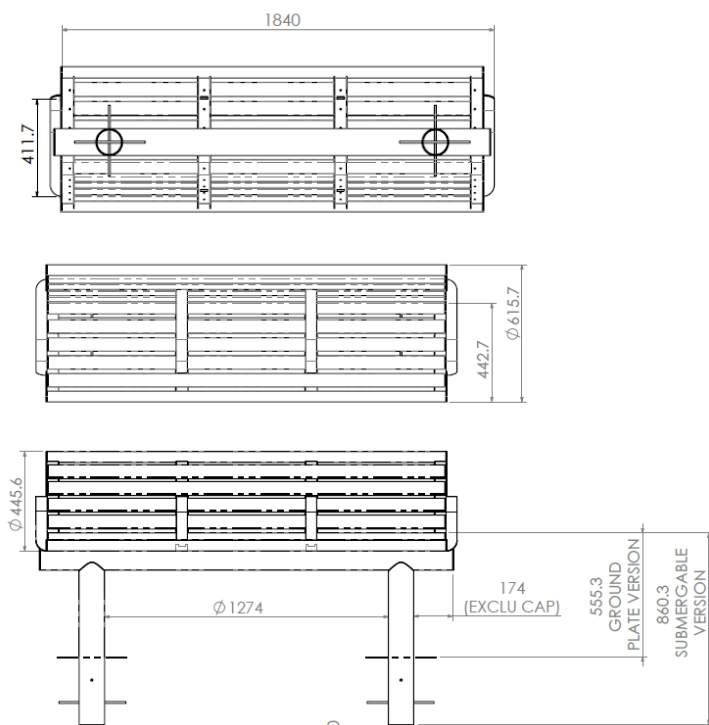

1

Choose Your Frame Colour

Made from galvanised steel, our choice of frame colour offers a high-quality finish.

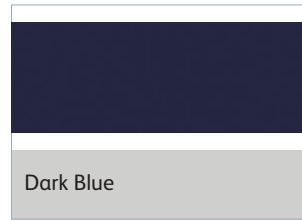
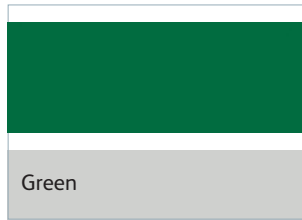
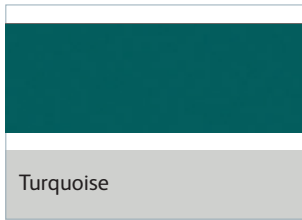
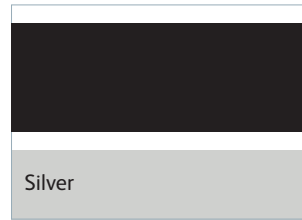
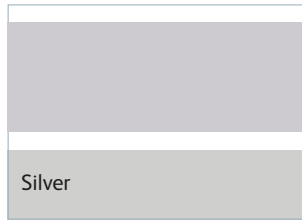
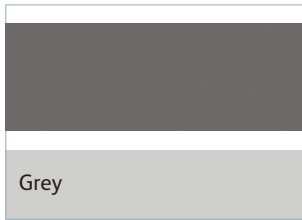

2

Choose Your Wood Finish

Whichever wood finish you go for, you're guaranteed a stunning bench.

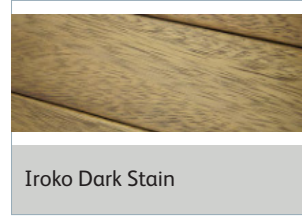
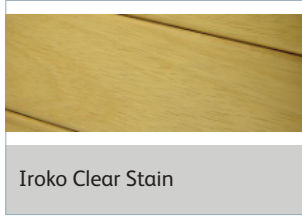

3

Optional Extras & Fixing Options

Customise your bench further and make the installation process hassle-free.

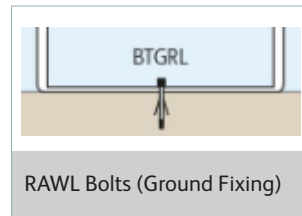
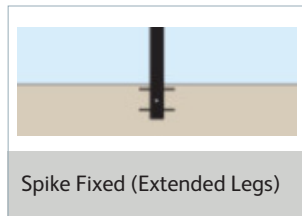



Named after the Founder of Wybone, this bench stands out in historic and modern areas.



Made from exotic Iroko wood for the seats and backrest.



Galvanised steel is used for the frames, legs and optional arm rests for rust and corrosion resistance.

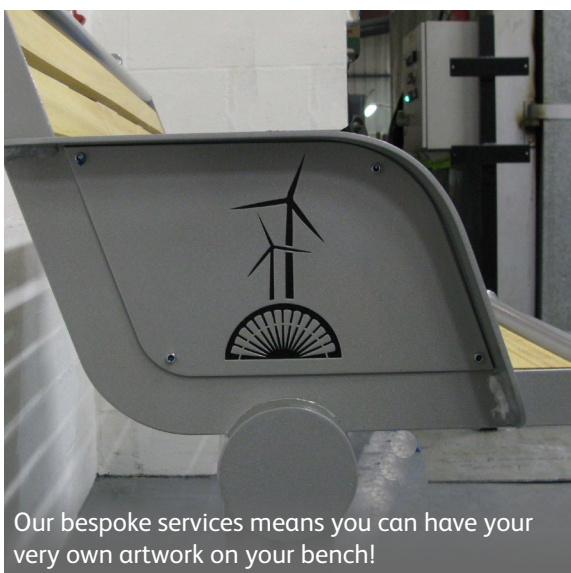

Our bespoke services means you can have your very own artwork on your bench!



Optional arm rests for improved comfortability and seat segregation.