



MANWAYS
MANWAYS | ACCESS HATCHES | DOORS
A HpE Process Company



OVER 25 YEARS OF SUCCESS

www.hpeprocess.com

Contents

Installation	4
Certification.....	4
Seals	5
Round External Doors – Single Arm, Hinged.....	6
Round External Doors – Single Arm, Hinged with Hygienic Lip Seal & Retention Free Cover	8
Round External Doors – Single Arm, Hinged.....	9
Round External Doors – Multi Hand Wheels, Loose Lid	10
Round External Doors – Multi Hand Wheels with Hinge	11
Round External Doors – Rim Clamp, Loose Lid	12
Round External Doors- Hinged & Hand Fastened.....	13
Other Round External Doors	14
Round External Pressure Doors - Design & Approval CODAP 2000.....	16
Round External Pressure Doors – PED Approved	17
Oval Doors.....	20
Oval Doors Retention Free Cover	22
Oval Doors – Retention Free Cover – Design & Approval CODAP 2000.....	23
Oval, Autoclave Door	24
Oval, PED Compliant Doors.....	26
Rectangular, Autoclave Doors.....	27
Rectangular Doors.....	28
Other Options	33
SGT Type Weld in Sightglass DIN 8902	34
Versaline RSB Type Rotating Sprayball	36
Sprayball Types	38
Other Tank Equipment.....	45
Adjustable Tank Feet.....	45
Light Duty Adjustable Feet.....	45
Hygienic Machine Feet.....	46
Medium Duty Adjustable Feet	47
Heavy Duty Aseptic Feet	48
Heavy Duty Hygienic Feet	49
Stainless Steel Stems, Plastic Bases	50
Stainless Steel Stems, Stainless Bases.....	51
Pressure Equalising Valve	52
Pressure Equalising Valve	52
Float Valve.....	52



Pressure Relief Valves	53
Tank Outlet Valves	53
Sampling Valve PEMS IV.....	54
Sampling Valve PEMS II.....	54
Hypodermic Sample Point.....	54
Aseptic Sampling Valve	54
Manway Seals and Spares.....	54



Company Information

Manways was formed to support our dedication to quality regarding the supply of manways and other tank equipment. A dedicated website means that industry professionals have immediate access to required information with the assurance that they are dealing with an established, reputable company.

Manways is part of HpE Process which has been established for over 25 years and with over 150 years combined experience in hygienic fluid handling processes.

Our aim is to provide a first-class service, with quality products, at competitive prices. Our experienced sales team have the wealth of knowledge and are on hand to ensure you find the equipment best suited to your application as well as offering technical advice if needed.

The following statement is to ensure that you get the level of service you need:

- Where possible all enquires will be responded to on the same day. If we are unable to do this we will advise you when we will be able to do so.
- All orders made via www.manways.co.uk will generate an acknowledgement when the order is processed.
- Advise if Certificates of Conformity / Material Certificates are required and they will be despatched with the order.
- CAD Drawings for many of the manways are included on the site, these can be downloaded by your own system, for integration into your design.
- Full datasheets on all items are available by email, fax, or post.

If you have any queries, or would like further information please visit www.manways.co.uk

Contact Information

Email: Info@manways.co.uk

Tel: 0113 252 6712

Fax: 0113 253 8125

NB: Please note all the information given in this catalogue was current at the time of publishing. The catalogue is subject to change at any time. Before ordering, please contact us to ensure all data is current.

Installation

In order to avoid the possibility of distortion during the welding of the neck ring, it is recommended that the neck ring be tack welded first in eight diametrically opposite positions as shown below before applying the full weld bead.

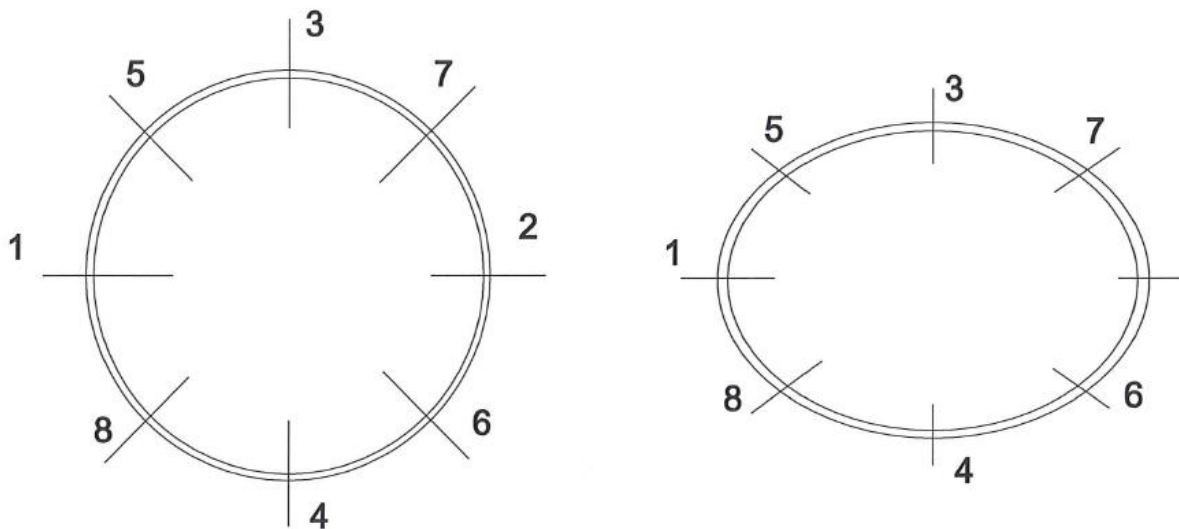

Certification

CODAP2000 Certification

This is the French equivalent of the BSI Standards, or the German TÜV. Design calculations to this standard must conform to the CODAP 2000 specifications and the final design must be approved.

PED Certification

THE PED applies to the design, manufacture and conformity assessment of pressure equipment and assemblies of pressure equipment with a maximum allowable pressure greater than 0.5 bar.

Guidelines specifically exclude 'covers', collars, gaskets and flanges' and 'sight glasses with frames' from the definition of 'pressure accessory'. Therefore, these items do not need to be CE marked.

These items are classed as 'components of pressure equipment' and are therefore part of an assembly which must be CE marked by the manufacturer.

Manways Statement

All PED approved doors are designed to recognise standards (eg TÜV / CODAP 2000) for use on vessels to comply with PED 97/23/EC and will be supplied with a documentation package including material certificates, design calculations and test results.

Seals

Type of Seal	Colour	FDA	Maximum Temperature
Joints Alimentaires – Food Quality Seals			
BUTYL	Orange	Section 21 (CFR 177.2600)	-20°C / +110°C
EPDM	Grey	Section 21 (CFR 177.2600)	-40°C / +130°C
FEP-SILICONE	Red, Transparent core	Section 21 (CFR 1.77.1550)	-50°C / +200°C
FEP-F.P.M (VITON®*)	Black, Transparent core	Section 21 (CFR 1.77.1550)	-10°C / +200°C
F.P.M (VITON®*)	Black	Section 21 (CFR 177.2600)	-10°C / +200°C
NATUREL	Off White	Section 21 (CFR 177.2600)	-40°C / +70°C
NÈOPRÈNE	Green	Section 21 (CFR 177.2600)	-20°C / +90°C
NITRILE (NRB)	Bronze	Section 21 (CFR 177.2600)	-20°C / +110°C
SILICONE	White Yellow	Section 21 (CFR 177.2600)	-50°C / +200°C
SILICONE HIGH TEMPERATURE	Brown	Section 21 (CFR 177.2600)	-50°C / +250°C
SILICONE WATER STREAM	Yellow	Section 21 (CFR 177.2600)	-50°C / +200°C
SILICONE-USP PHARMA	Red	Section 21 (CFR 177.2600) (USP 23 classe VI)	-50°C / +200°C
FPM BNIC	Black	Section 21 (CFR 177.2600)	-10°C / +200°C
Joints Alimentaires – Non Food Grade			
AFLAS	Black and White	-	-10°C / +250°C (Max +300C)
F.S.I	Blue	-	-50°C / +200°C

On request rope per meter	Fibre Glass (450°C)	Carbon / Graphite Fiber (650°C)	PTFE + Aramide Fiber (280°C)
---------------------------	---------------------	---------------------------------	------------------------------

*Viton® is a registered trademark of DuPont Performance Elastomers.

Round External Doors - Single Arm, Hinged

P33 -150

Access Diameter: 150mm
Door Thickness: 2mm
Frame Thickness: 2mm
Frame Height: 80mm
Weight: 2kg
Max Working Pressure: 0.4 bar

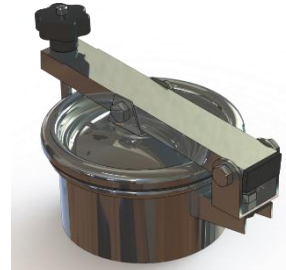

P33-200

Access Diameter: 196mm
Door Thickness: 1.5mm
Frame Thickness: 2mm
Frame Height: 80mm
Weight: 3kg
Max Working Pressure: 0.3 bar



P33-114

Access Diameter: 204mm
Door Thickness: 2mm
Frame Thickness: 8mm
Frame Height: 50mm
Weight: 4kg
Max Working Pressure (Full Vacuum): 0.8 bar



P33-255

Access Diameter: 250mm
Door Thickness: 2mm
Frame Thickness: 6mm
Frame Height: 60mm
Weight: 6kg
Max Working Pressure: 0.3 bar



P33-315

Access Diameter: 354mm
Door Thickness: 2mm
Frame Thickness: 8mm
Frame Height: 50mm
Weight: 9kg
Max Working Pressure: 0.4 bar



Round External Doors - Single Arm, Hinged



Material: 316L
 Finish: Electropolish
 Seal: EPDM as standard
 Seal Options: Nitrile, Neoprene, Silicon, Viton, Natural Rubber

P33-300

Access Diameter: 300mm
 Door Thickness: 1.5mm
 Frame Thickness: 2mm
 Frame Height: 80mm
 Max Working Pressure: 0.2 bar

P33-500

Access Diameter: 500mm
 Door Thickness: 2mm
 Frame Thickness: 2mm
 Frame Height: 80mm
 Max Working Pressure: 0.05 bar

P33-400

Access Diameter: 400mm
 Door Thickness: 1.5mm
 Frame Thickness: 2mm
 Frame Height: 80mm
 Max Working Pressure: 0.1 bar

P33-600

Access Diameter: 600mm
 Door Thickness: 2mm
 Frame Thickness: 2mm
 Frame Height: 80mm
 Max Working Pressure: 0.005 bar

Round External Doors - Single Arm, Hinged with Hygienic Lip Seal & Retention Free Cover

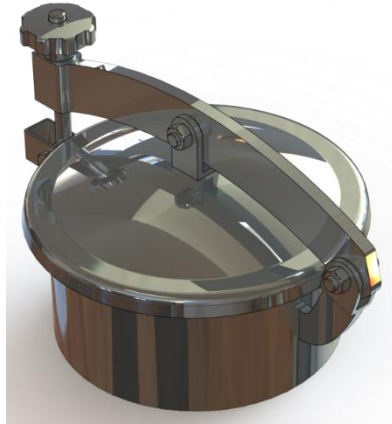

Material: 316L
Finish: Electropolish
Seal: As standard
Seal Options: EPDM, Viton

P31-200

Access Diameter: 200mm
Door Thickness: 3mm
Frame Thickness: 3mm
Frame Height: 100mm
Max Working Pressure: 0.8 bar

P31-500

Access Diameter: 500mm
Door Thickness: 3mm
Frame Thickness: 3mm
Frame Height: 100mm
Max Working Pressure: 0.1 bar

P31-300

Access Diameter: 300mm
Door Thickness: 3mm
Frame Thickness: 3mm
Frame Height: 100mm
Max Working Pressure: 0.2 bar

P31-600

Access Diameter: 600mm
Door Thickness: 3mm
Frame Thickness: 3mm
Frame Height: 100mm
Max Working Pressure: 0.05 bar

P31-400

Access Diameter: 430mm
Door Thickness: 3mm
Frame Thickness: 3mm
Frame Height: 100mm
Max Working Pressure: 0.1 bar

Round External Doors - Single Arm, Hinged



Upper lid aseptic in 316 Stainless Steel (304 as an option)

Special frame heights available on request

D8-200

Access Diameter: 200mm
Door Thickness: 2mm
Frame Thickness: 2.5mm
Frame Height: 100mm
Max Working Pressure: 0.2 bar

D8-460

Access Diameter: 460mm
Door Thickness: 2.5mm
Frame Thickness: 2.5mm
Frame Height: 100mm
Max Working Pressure: 0.2 bar

D8-300

Access Diameter: 300mm
Door Thickness: 2mm
Frame Thickness: 2.5mm
Frame Height: 100mm
Max Working Pressure: 0.2 bar

D8-500

Access Diameter: 500mm
Door Thickness: 2.5mm
Frame Thickness: 2.5mm
Frame Height: 100mm
Max Working Pressure: 0.05 bar

D8-420

Access Diameter: 420mm
Door Thickness: 2.5mm
Frame Thickness: 2.5mm
Frame Height: 100mm
Max Working Pressure: 0.2 bar

D8-600

Access Diameter: 600mm
Door Thickness: 2.5mm
Frame Thickness: 2.5mm
Frame Height: 100mm
Max Working Pressure: 0.05 bar

Round External Doors - Multi Hand Wheels, Loose Lid

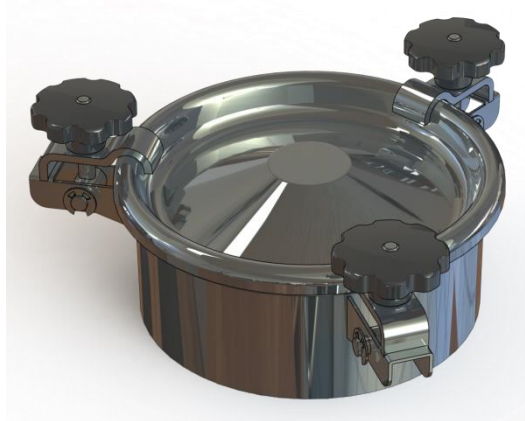

Material: 316L
 Finish: Electropolish
 Seal: EPDM as standard
 Seal Options: Nitrile, Neoprene, Viton, Natural Rubber, FEP

P33-196

Access Diameter: 196mm
 Door Thickness: 1.5mm
 Frame Thickness: 2mm
 Frame Height: 80mm
 No of Clamps: 3
 Max Working Pressure: 0.6 bar

P33-501

Access Diameter: 500mm
 Door Thickness: 2mm
 Frame Thickness: 2mm
 Frame Height: 80mm
 No of Clamps: 5
 Max Working Pressure: 0.3 bar

P33-301

Access Diameter: 300mm
 Door Thickness: 1.5mm
 Frame Thickness: 2mm
 Frame Height: 80mm
 No of Clamps: 3
 Max Working Pressure: 0.3 bar

P33-601

Access Diameter: 600mm
 Door Thickness: 2mm
 Frame Thickness: 2mm
 Frame Height: 80mm
 No of Clamps: 6
 Max Working Pressure: 0.1 bar

P33-401

Access Diameter: 430mm
 Door Thickness: 1.5mm
 Frame Thickness: 2mm
 Frame Height: 80mm
 No of Clamps: 4
 Max Working Pressure: 0.3 bar

Round External Doors - Multi Hand Wheels with Hinge



Code	P06D2
Description:	<p>+/-1 bar multi clamp with hinge non PED. Full Vacuum Special frame heights are available on request (minimum quantities will apply) 300mm to 800mm diameter suitable for 1 bar 4mm Lid Thickness 6mm Thick Neckring</p> <p>*150 - 250mm Diameter suitable for -1 to +15 bar 18mm Lid Thickness 8mm Thick Neckring</p>
Material:	316 (304 available as an option)
Finish:	Standard brushed finish, option of polishing to customer specification.

Round External Doors - Rim Clamp, Loose Lid

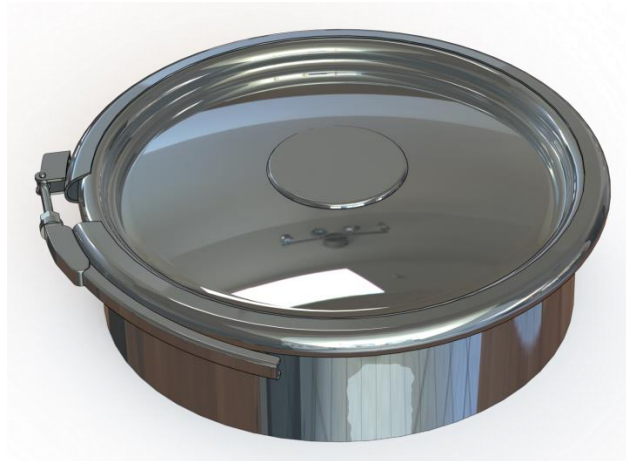

Material: 316L
 Finish: Electropolish
 Seal: EPDM as standard
 Seal Options: Nitrile, Neoprene, Silicon, Natural Rubber, PTFE Braided

P32-305

Access Diameter: 300mm
 Door Thickness: 1.5mm
 Frame Thickness: 2mm
 Frame Height: 80mm
 Max Working Pressure: 1.2 bar

P32-705

Access Diameter: 500mm
 Door Thickness: 2mm
 Frame Thickness: 2mm
 Frame Height: 80mm
 Max Working Pressure: 0.6 bar

P32-405

Access Diameter: 400mm
 Door Thickness: 1.5mm
 Frame Thickness: 2mm
 Frame Height: 80mm
 Max Working Pressure: 1 bar

P32-805

Access Diameter: 600mm
 Door Thickness: 2mm
 Frame Thickness: 2mm
 Frame Height: 80mm
 Max Working Pressure: 0.6 bar

Round External Doors - Hinged & Hand Fastened

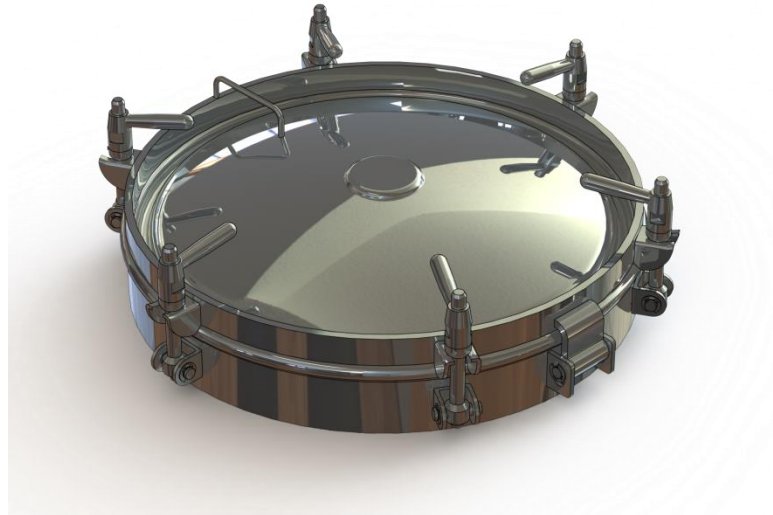

Material: 316L
 Finish: Electropolish
 Seal: EPDM as standard
 Seal Options: Nitrile, Neoprene, Silicon, Natural Rubber

P22-265

Access Diameter: 504mm
 Door Thickness: 2mm
 Frame Thickness: 8mm
 Frame Height: 50mm
 No of Clamps: 6
 Max Working Pressure: 1 bar
 Vacuum Pressure: -0.9 bar

P22-286

Access Diameter: 604mm
 Door Thickness: 2mm
 Frame Thickness: 8mm
 Frame Height: 50mm
 No of Clamps: 8
 Max Working Pressure: 1.2 bar
 Vacuum Pressure: -0.5 bar

P22-266

Access Diameter: 604mm
 Door Thickness: 2mm
 Frame Thickness: 8mm
 Frame Height: 50mm
 No of Clamps: 6
 Max Working Pressure: 0.9 bar
 Vacuum Pressure: -0.5 bar

Other Round External Doors

P33 -212

Access Diameter: 504mm
Door Thickness: 2mm
Frame Thickness: 8mm
Frame Height: 50mm
Weight: 13kg
Max Working Pressure: 0.1 bar
Vacuum Pressure: -0.8 bar



P33-213

Access Diameter: 604mm
Door Thickness: 2mm
Frame Thickness: 8mm
Frame Height: 50mm
Weight: 14kg
Max Working Pressure: 0.1 bar
Vacuum Pressure: -0.5 bar



Other Round External Doors



D15-420

Access Diameter: 420mm
Door Thickness: 2.5mm
Frame Thickness: 2.5mm
Frame Height: 100mm
Max Working Pressure: 0.3 bar

D15-500

Access Diameter: 500mm
Door Thickness: 2.5mm
Frame Thickness: 2.5mm
Frame Height: 100mm
Max Working Pressure: 0.2 bar

D15-460

Access Diameter: 460mm
Door Thickness: 2.5mm
Frame Thickness: 2.5mm
Frame Height: 100mm
Max Working Pressure: 0.3 bar

D15-600

Access Diameter: 600mm
Door Thickness: 2.5mm
Frame Thickness: 2.5mm
Frame Height: 100mm
Max Working Pressure: 0.1 bar

**Round External Pressure Doors
Design & Approval CODAP 2000**

P22 -238

Access Diameter: 204mm
Door Thickness: 2mm
Frame Thickness: 8mm
Frame Height: 60mm
Weight: 6kg
Max Working Pressure: 8 bar
Full Vacuum
Anti-retention cover
Optional heat insulation

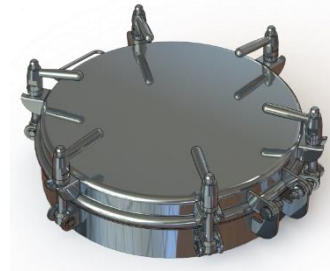

P22-239

Access Diameter: 354mm
Door Thickness: 2.5mm
Frame Thickness: 8mm
Frame Height: 50mm
Weight: 11kg
Max Working Pressure: 3 bar
Full Vacuum
Optional heat insulation

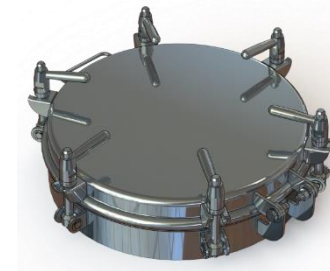

P22-249

Access Diameter: 354mm
Door Thickness: 2.5mm
Frame Thickness: 8mm
Frame Height: 50mm
Weight: 12kg
Max Working Pressure: 4 bar
Full Vacuum
Optional heat insulation



**Round External Pressure Doors
PED Approved**



Material: 316L
 Finish: Electropolish, beadblast or to customers specification
 Seal: EPDM as standard, various alternatives available
 Full Vacuum
 Pressure Rating: Maximum allowed working pressure at 150°C

- These doors are supplied to CODAP 2000 and are complete with PED complaint certification of material and manufacturers calculation.
- Extras available are spring assisted opening, SYJA System, construction to ASME or TUV standards.

Code	Diameter (mm)	Pressure Ratings			No of Bolts	Frame Height (mm)	Weight (kg)
		CODAP 2000	ASME	TUV			
P22-233	204	8			3	100	16
P22-333	354	4			3	100	23
P22-354	354	5.6			4	100	25
P22-433	400	3	3	2.8	4	100	33
P22-444	400	4.34	6	3.5	5	100	3.4
P22-449	400	8.5	8.5	6.4	09	100	40

Round External Pressure Doors PED Approved

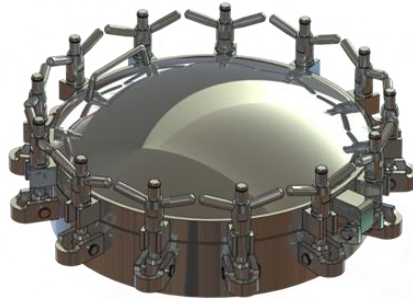

Material: 316L
 Finish: Electropolish, beadblast or to customers specification
 Seal: EPDM as standard, various alternatives available
 Full Vacuum
 Pressure Rating: Maximum allowed working pressure at 150°C

- These doors are supplied to CODAP 2000 and are complete with PED complaint certification of material and manufacturers calculation.
- Extras available are spring assisted opening, SYJA System, construction to ASME or TUV standards.

Code	Diameter (mm)	Pressure Ratings			No of Bolts	Frame Height (mm)	Weight (kg)
		CODAP 2000	ASME	TUV			
P22-443	460	3.6	3.6	2.7	5	100	37
P22-454	460	4.1	4.1	3.3	6	100	39
P22-459	460	7.3	7.3	6	11	100	47
P22-553	500	3.5	3.5	2.7	6	100	43
P22-564	500	4.5	4.5	3.2	7	100	44
P22-569	500	7.5	7.5	6	13	100	54
P22-664	600	3			7	100	50
P22-667	600	5			10	100	54
P22-669	600	7			14	100	58

**Round External Pressure Doors
PED Approved**

Model: P06/D13
Material: 316L (304 available as an option)
Optional: Sight Glass
Full Vacuum



Working pressure quoted is at 150°C.

Please contact for details of maximum working pressures at alternative temperatures.

Diameter (mm)	No of Clamps	Door Thickness (mm)	Frame Thickness (mm)	Frame Height (mm)	Working Pressure (bar) @150°C
300	4	4	4	100	4.0
	6	4	4	100	7.5
	8	5	4	100	9.0
400	4	4	4	100	1.5
	6	4	4	100	4.0
	8	4	4	100	6.0
	10	5	4	100	7.5
	12	5	4	100	8.5
450	4	4	4	100	1.0
	6	4	4	100	3.0
	8	4	4	100	4.5
	10	4	4	100	6.0
	12	5	4	100	7.0
500	4	4	4	100	1.0
	6	4	4	100	2.0
	8	4	4	100	3.5
	10	4	4	100	4.5
	12	4	4	100	5.5
	14	5	4	100	6.5
600	6	4	4	100	1.0
	8	4	4	100	2.0
	10	4	4	100	3.5
	12	4	4	100	4.0
	14	4	4	100	4.5

Oval Doors

P21 -303

Access Opening: 307 x 442mm
Door Thickness: 2mm
Frame Thickness: 8mm
Frame Height: 50mm
Weight: 9kg
Max Working Pressure: 0.3 bar
Full Vacuum



P21-407

Access Opening: 307 x 442mm
Door Thickness: 2mm
Frame Thickness: 8mm
Frame Height: 50mm
Weight: 10kg
Max Working Pressure: 0.3 bar
Full Vacuum



P21-116

Access Opening: 407 x 452mm
Door Thickness: 2.5mm
Frame Thickness: 8mm
Frame Height: 50mm
Weight: 14kg
Max Working Pressure: 0.5 bar
Full Vacuum

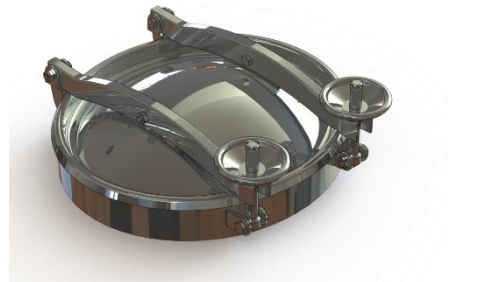

P06-A2

Access Opening: 440 x 340mm
Door Thickness: 3mm
Frame Thickness: 30mm
Frame Height: 12mm
Max Working Pressure: 3.2 bar



Oval Doors

P06 -A3

Access Opening: 440 x 310mm
 Door Thickness: 2.5mm
 Frame Thickness: 35mm
 Frame Height: 10 / 12mm
 Max Working Pressure: 3.2 bar



P06-A27 – Tapered frame for improved cleaning

Access Opening: 520 x 420mm
 Above Door Thickness: 3mm
 Frame Thickness: 3mm
 Frame Height: 78mm max
 Max Working Pressure: 3.0 bar



P06-A15 (60mm frame) P06-A16A (100mm frame)

Access Opening: 520 x 420mm
 Door Thickness: 3mm
 Frame Thickness: 12mm
 Frame Height: **
 Weight: 14kg
 Max Working Pressure: 8.0 bar



P06-A26

Access Opening: 520 x 420mm
 Door Thickness: 3mm
 Frame Thickness: 30mm
 Frame Height: 10mm max
 Max Working Pressure: 3.0 bar



**Oval Doors
Retention Free Cover**

P21 -503

Access Diameter: 307 x 442mm
Door Thickness: 2mm
Frame Thickness: 8mm
Frame Height: 50mm
Weight: 12kg
Max Working Pressure: 0.3 bar
Full Vacuum
Retention free cover



P21-507

Access Diameter: 307 x 442mm
Door Thickness: 2mm
Frame Thickness: 8mm
Frame Height: 50mm
Weight: 13kg
Max Working Pressure: 0.3 bar
Full Vacuum
Retention free cover



P21-516

Access Diameter: 407 x 452mm
Door Thickness: 2.5mm
Frame Thickness: 8mm
Frame Height: 50mm
Weight: 18kg
Max Working Pressure: 0.3 bar
Full Vacuum
Retention free cover, vertical opening

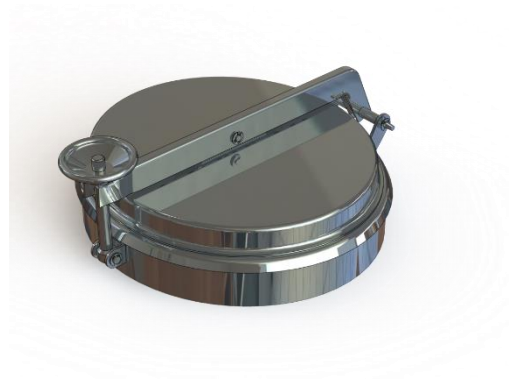

Oval Doors
Retention Free Cover - Design & Approval CODAP 2000

P21 -147

Access Diameter: 407 x 452mm
Door Thickness: 4mm
Frame Thickness: 8mm
Frame Height: 50mm
Weight: 16kg
Max Working Pressure: 3 bar
Full Vacuum
Retention free cover, vertical opening

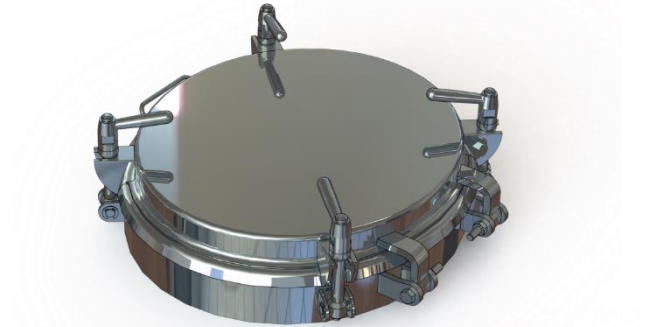

P21-167

Access Diameter: 407 x 452mm
Door Thickness: 4mm
Frame Thickness: 8mm
Frame Height: 50mm
Weight: 17kg
Max Working Pressure: 4 bar
Full Vacuum
Retention free cover

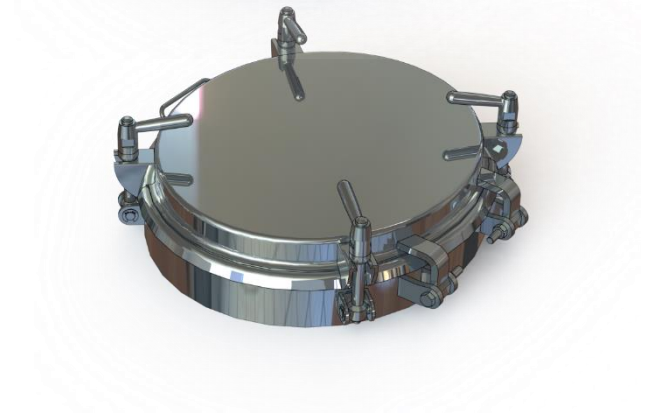

Oval, Autoclave Doors

P11 -101

Access Opening: 307 x 442mm
Door Thickness: 2mm
Frame Thickness: 8mm
Frame Height: 60mm
Weight: 8kg
Max Working Pressure: 1.6 bar
Vertical opening



P11-102

Access Opening: 307 x 442mm
Door Thickness: 2mm
Frame Thickness: 8mm
Frame Height: 60mm
Weight: 8kg
Max Working Pressure: 1.6 bar
Horizontal opening

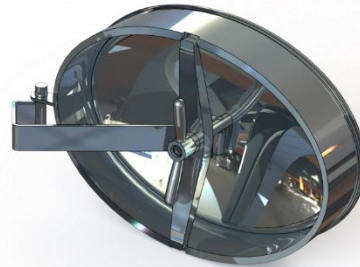

P11-103

Access Opening: 307 x 442mm
Door Thickness: 2mm
Frame Thickness: 8mm
Frame Height: 60mm
Weight: 9kg
Max Working Pressure: 1.6 bar
Horizontal opening

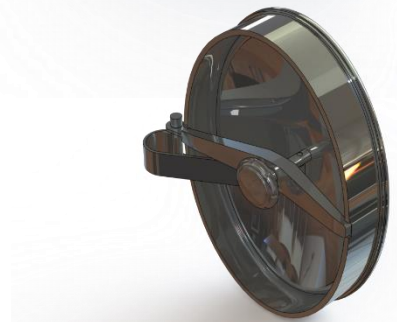

P11-129

Access Opening: 407 x 452mm
Door Thickness: 4mm
Frame Thickness: 12mm
Frame Height: 60mm
Weight: 16kg
Max Working Pressure: 5 bar
Vertical opening



Oval, Autoclave Doors

P11 -340-440 ED

Access Opening: 340 x 440mm
Door Thickness: 3mm
Frame Thickness: 4mm
Frame Height: 80mm
Max Working Pressure: 2.4 bar

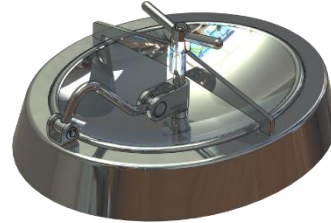

P11-410-510

Access Opening: 410 x 510mm
Door Thickness: 2.5mm
Frame Thickness: 10mm
Frame Height: 60mm
Max Working Pressure: 2 bar

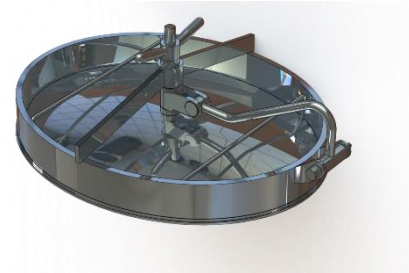

Oval, PED Compliant Doors

P06 -A11

Access Opening: 480 x 370mm
 Frame Thickness: 12mm
 Frame Height: 100mm

PED

Door Thickness: 4mm
 Max Working Pressure: 3 bar

Door Thickness: 6mm
 Max Working Pressure: 9 bar

Door Thickness: 10mm
 Max Working Pressure: 15 bar



P06-A17

Access Opening: 440 x 340mm
 Door Thickness: 5mm
 Frame Thickness: 30mm
 Frame Height: 12mm
 Max Working Pressure: 8 bar
 (At working temperature +50°C / -10°C)



P06-A18

Access Opening: 440 x 340mm
 Door Thickness: 5mm
 Frame Thickness: 5mm
 Frame Height: 80mm
 Max Working Pressure: 8 bar
 (At working temperature +50°C / -10°C)



Rectangular, Autoclave Doors

P13-105

Access Opening: 314 x 424mm
Door Thickness: 2mm
Frame Thickness: 8mm
Frame Height: 60mm
Frame Radius: 98mm
Weight: 9kg
Max Working Pressure: 1.3 bar

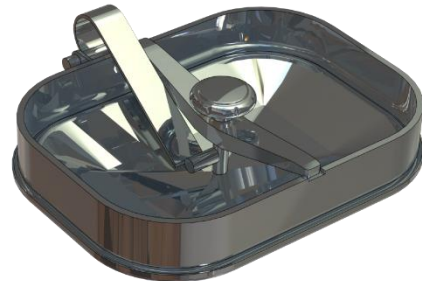

P13-409

Access Opening: 410 x 534mm
Door Thickness: 2.5mm
Frame Thickness: 8mm
Frame Height: 60mm
Frame Radius: 98mm
Weight: 16kg
Max Working Pressure: 1.0 bar



P13-410

Access Opening: 410 x 534mm
Door Thickness: 2.5mm
Frame Thickness: 8mm
Frame Height: 60mm
Frame Radius: 98mm
Weight: 16kg
Max Working Pressure: 1.0 bar

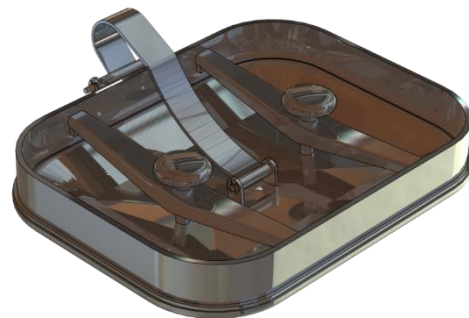

Rectangular Doors

P23-111

Access Opening: 410 x 534mm
 Door Thickness: 2mm
 Frame Thickness: 2mm
 Frame Height: 60mm
 Frame Radius: 98mm
 Weight: 18kg
 Max Working Pressure: 0.6 bar
 Vacuum Pressure: -0.5 bar

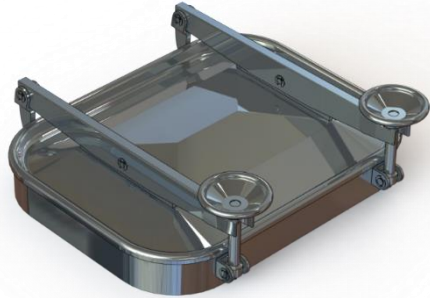

P23-113

Access Opening: 410 x 534mm
 Door Thickness: 2mm
 Frame Thickness: 8mm
 Frame Height: 50mm
 Frame Radius: 98mm
 Weight: 20kg
 Max Working Pressure: 0.6 bar
 Vacuum Pressure: -0.5 bar

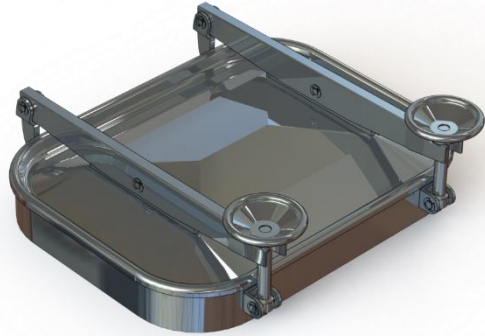

P23-201

Access Opening: 314 x 424mm
 Door Thickness: 2mm
 Frame Thickness: 8mm
 Frame Height: 50mm
 Frame Radius: 98mm
 Weight: 13kg
 Max Working Pressure: 1.6 bar
 Vacuum Pressure: -0.8 bar
 Hinge on long side

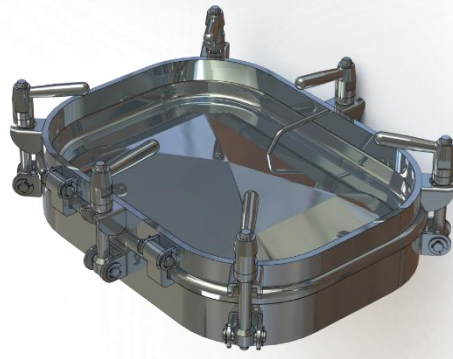

P23-202

Access Opening: 314 x 424mm
 Door Thickness: 2mm
 Frame Thickness: 8mm
 Frame Height: 50mm
 Frame Radius: 98mm
 Weight: 13kg
 Max Working Pressure: 1.6 bar
 Vacuum Pressure: -0.8 bar
 Hinge on short side

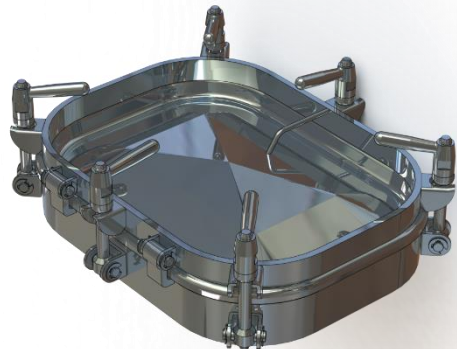

Rectangular Doors

P23-203

Access Opening: 410 x 534mm
 Door Thickness: 2.5mm
 Frame Thickness: 8mm
 Frame Height: 50mm
 Frame Radius: 98mm
 Weight: 18kg
 Max Working Pressure: 1.2 bar
 Full Vacuum
 Hinge on long side

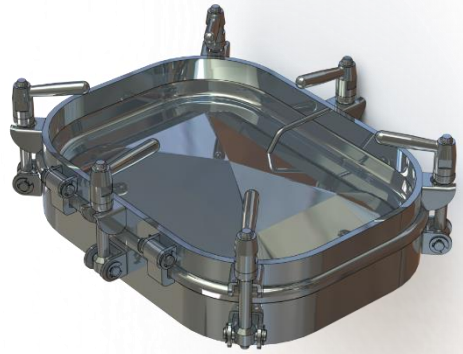

P23-204

Access Opening: 410 x 534mm
 Door Thickness: 2.5mm
 Frame Thickness: 8mm
 Frame Height: 50mm
 Frame Radius: 98mm
 Weight: 18kg
 Max Working Pressure: 1.2 bar
 Full Vacuum
 Hinge on short side

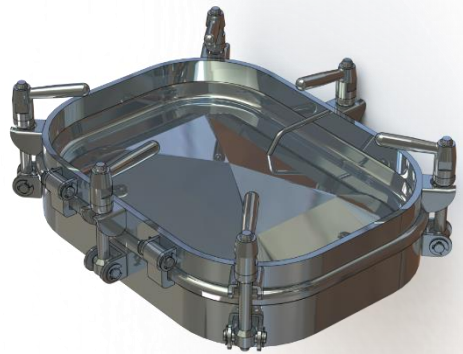

P23-210

Access Opening: 314 x 424mm
 Door Thickness: 2mm
 Frame Thickness: 8mm
 Frame Height: 50mm
 Frame Radius: 98mm
 Weight: 11kg
 Max Working Pressure: 0.8 bar
 Vacuum Pressure: -0.8 bar



P23-211

Access Opening: 314 x 424mm
 Door Thickness: 2mm
 Frame Thickness: 8mm
 Frame Height: 50mm
 Frame Radius: 98mm
 Weight: 13kg
 Max Working Pressure: 0.6 bar
 Vacuum Pressure: -0.8 bar



Rectangular Doors

P23-307

Access Opening: 314 x 424mm
Door Thickness: 2mm
Frame Thickness: 8mm
Frame Height: 50mm
Frame Radius: 98mm
Weight: 10kg
Max Working Pressure: 0.3 bar
Vacuum Pressure: -0.8 bar

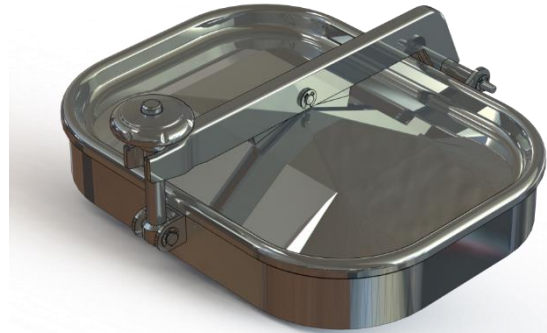

P23-308

Access Opening: 314 x 424mm
Door Thickness: 2mm
Frame Thickness: 8mm
Frame Height: 50mm
Frame Radius: 98mm
Weight: 10kg
Max Working Pressure: 0.3 bar
Vacuum Pressure: -0.8 bar



P23-680

Access Opening: 600 x 800mm
Door Thickness: 3mm
Frame Thickness: 10mm
Frame Height: 80mm
Weight: 54kg
Max Working Pressure: 0.8 bar

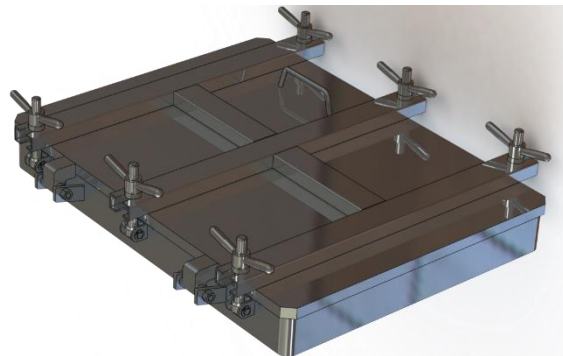

P23-810

Access Opening: 800 x 1000mm
Door Thickness: 3mm
Frame Thickness: 10mm
Frame Height: 80mm
Weight: 82kg
Max Working Pressure: 0.8 bar



Rectangular Doors

P03-295

Access Opening: 234 x 184mm
Door Thickness: 1.2mm
Frame Thickness: 5mm
Frame Height: 40mm
Frame Radius: 20mm
Weight: 3.2kg
Max Working Pressure: 0.6 bar
Full Vacuum



P06-B3

Access Opening: 500 x 310mm
Door Thickness: 2.5mm
Frame Thickness: 10mm
Frame Height: 60mm
Max Working Pressure: 1.3 bar
Full Vacuum



P06-B4

Access Opening: 420 x 310mm
Door Thickness: 2mm
Frame Thickness: 10mm
Frame Height: 60mm
Max Working Pressure: 1.6 bar
Full Vacuum



P06-B5

Access Opening: 420 x 310mm
Door Thickness: 2mm
Frame Thickness: 10mm
Frame Height: 60mm
Max Working Pressure: 0.7 bar
Full Vacuum



P06-B6

Access Opening: 530 x 410mm
Door Thickness: 2.5mm
Frame Thickness: 12mm
Frame Height: 60mm
Max Working Pressure: 1.1 bar
Full Vacuum



Rectangular Doors

P06-B7

Access Opening: 420 x 310mm
Door Thickness: 2mm
Frame Thickness: 10mm
Frame Height: 60mm
Max Working Pressure: 0.6 bar



P06-B23

Access Opening: 530 x 410mm
Door Thickness: 2.5mm
Frame Thickness: 12mm
Frame Height: 60mm
Max Working Pressure: 0.6 bar
Full Vacuum



P06-B24

Access Opening: 530 x 410mm
Door Thickness: 2.5mm
Frame Thickness: 12mm
Frame Height: 60mm
Max Working Pressure: 0.4 bar
Full Vacuum



P06-B1/600600

Access Opening: 600 x 600mm
Door Thickness: 4mm
Frame Thickness: 10mm
Frame Height: 70mm
Max Working Pressure: 1.0 bar
Full Vacuum

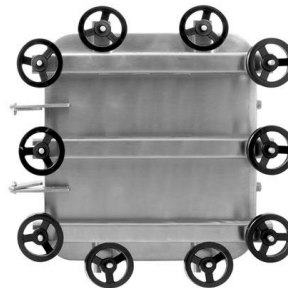

P06-B1/740450

Access Opening: 740 x 450mm
Door Thickness: 4mm
Frame Thickness: 10mm
Frame Height: 70mm
Max Working Pressure: 1.0 bar
Full Vacuum

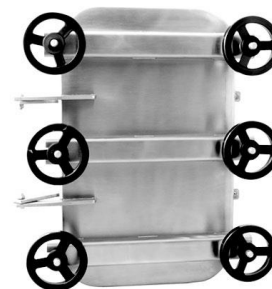

P06-B1/750750

Access Opening: 750 x 750mm
Door Thickness: 4mm
Frame Thickness: 10mm
Frame Height: 70mm
Max Working Pressure: 1.0 bar
Full Vacuum

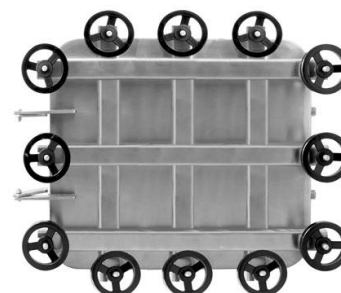

Other options

Manufactured in 316L stainless steel, these range of doors are specifically made for the water and effluent treatment industries.

For doors mounted below the liquid surface the inward opening door is recommended as the liquid head pressure will aid the sealing. Top mounted, outward opening doors are gas tight, the allowable gas pressure depending on the door size.

Other options include:

- Doors fitted with sight glass
- Available in 2" – 5" viewing diameter
- Safety screens
- Manways for grouting in concrete
- Manways for grouting in wooden vessels
- Company Name Etched



SGT Type Weld in Sightglass DIN8902



Applications: The compact design of this unit makes it ideal for inspection use in small bio-reactor vessels and the lids of Manways or inspection hatches. Used widely in the food, dairy, beverage, cosmetic and pharmaceutical industries.

Operating conditions: These units are available for pressures up to 10 Bar (depending on size, higher pressure ratings are available on request)

Parts list:

1. Welding male (1.43041/1.4404 material)
2. Nut (1.4301 material)
3. Gasket (Silicone, maximum temperature 200°C)
4. Sight glass disk (Borosilicate, maximum temperature 260°C)

Working pressure 10 Bar

Certificates: EN10204.3.1 certificate

Subject to modification without notice in advance

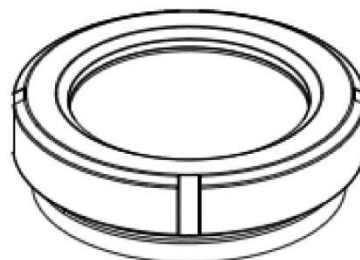
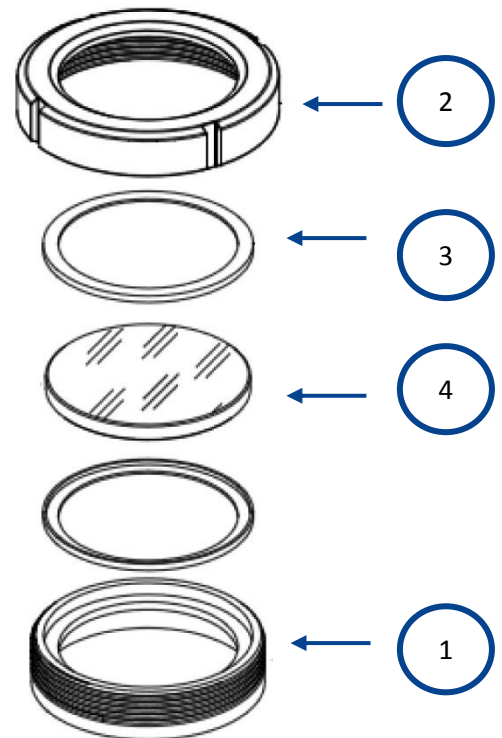

CODE	D1	D2	SG	D	H	P.R
All measurements are in MM						Bar
SGT50DPB/89	50	80 X 3	64.5 X 10	92	35	10
SGT60DPB/89	65	95 X 3	85 X 10	108	39	10
SGT80DPB/89	80	114 X 3	100 X 10	125	42	10
SGT100DPB/89	100	130 X 5	115 X 10	146	45	10

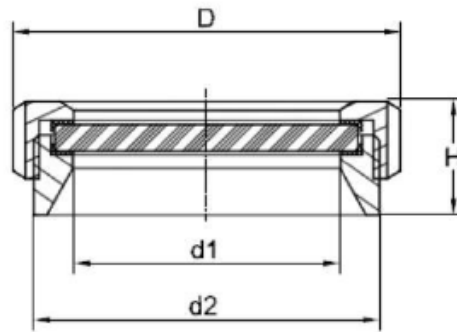

Standard straight edged design is a liquid trap when sight-glass is fitted to the side of a vessel.

Standard type design:

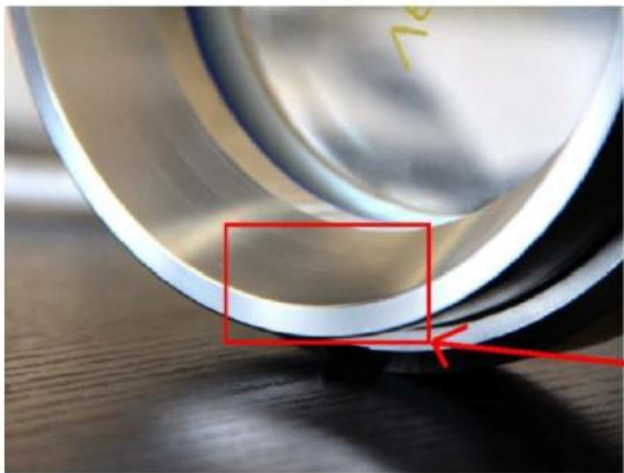
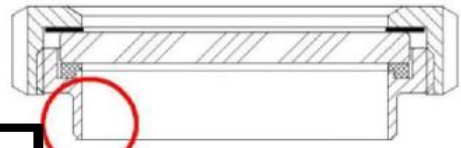

The Versaline design eliminates the possibility of trapped liquid due to its self-draining capability.

Versaline type design:

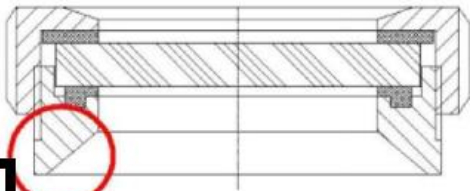

Versaline RSB Type Rotating Sprayball



Applications

Fluid driven rotating spray nozzles are ideal for use in tanks and vessels where a static sprayball is unable to clean sufficiently. The double bearing design ensures reliability and long service. They are available in slip on and BSP connection types. (See chart on following page for application data). The slip on type comes complete with a retaining pin/clip to eliminate any possible disconnection issues.

Operating Conditions

Designed to give excellent cleaning performance from relatively low (1 or 2 bar) fluid pressure

Ordering information

All available sizes and connection options are listed in the chart on the next page.



Versaline RSB Type Rotating Sprayball

CODE	CONNECTION TYPE	SIZE	FLOW RATE (M ³ / H)		BALL DIAMETER (MM)	H (MM)
			1 BAR	2 BAR		
SB45-360-05C/89	SLIP ON	0.5"	2.6	3.5	45	102
SB45-360-07C/89	SLIP ON	0.7"	4.1	5.5	45	115
SB45-360-02BSP/89	BSP	1/4"	2.6	3.5	45	102
SB45-360-05BSP/89	BSP	1/2"	4.1	5.5	45	115
SB45-360-10C/89	SLIP ON	1"	4.2	5.9	45	120
SB65-360-15C/89	SLIP ON	1.5"	11	15	65	150
SB45-360-07BSP/89	BSP	3/4"	4.2	5.9	45	120
SB65-360-10BSP/89	BSP	1"	11	15	65	150

Sprayballs

Sprayballs are manufactured in different sizes with options of connections and drilling patterns to suit various applications. The flow rate required will depend on factors such as: duration of the cleaning cycle, type and temperature of the cleaning fluid, the nature of the vessel contents etc.

Most industries have evolved their own cleaning procedures based on trial and experience with their own particular products, however as a general guide the flow rate required and hence the size or number of sprayballs required can be determined such as:

- For vertical tanks – Allow one cubic meter per hour for every meter of tank circumference
- For horizontal tanks – Allow one cubic meter per hour for 2 x diameters + 2 x length in meters

The pressure of the cleaning fluid at the sprayball should be between one and three bar. Higher pressures can result in fluid atomising and reducing the cleaning effect.

Please note that all values quoted in the following table are at 1 bar working pressure.

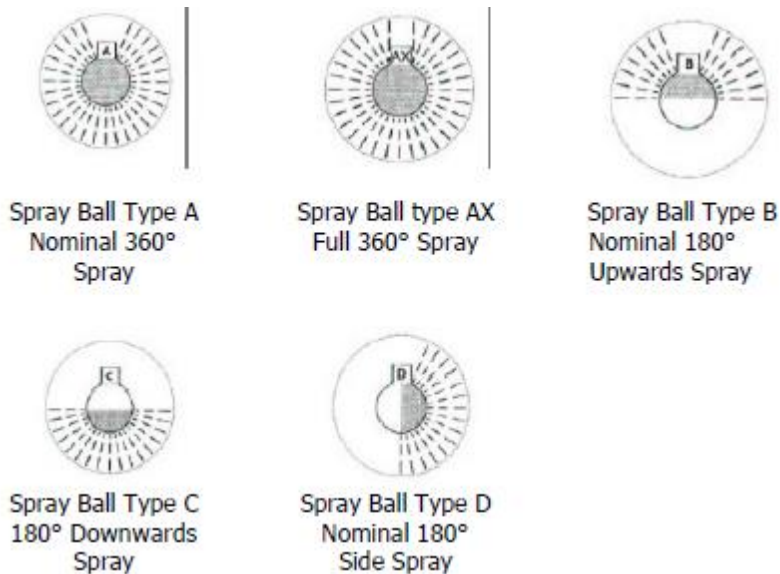

Sprayball Selection Chart

REF	HOLE (MM)	DIA (MM)	CONNECTION	H (MM)	FLOW (M3 / HR)	CLEANING RADIUS (M)
1A	2.5	65	1" CLIP	60	15.7	1.8
1B	2.5	65	1" CLIP	60	10.2	3.0
1C	2.5	65	1" CLIP	60	10.5	3.2
1D	2.5	65	1" CLIP	60	10.1	2.9
1AX	2.5	65	1" CLIP	57	15.7	1.8
1BX	2.5	65	1" CLIP	57	10.2	3.0
1DX	2.5	65	1" CLIP	57	10.1	2.9
1A	1.6	65	1" CLIP	60	8.6	3.3
1B	1.6	65	1" CLIP	60	5.3	4.9
1C	1.6	65	1" CLIP	60	5.5	5.3
1D	1.6	65	1" CLIP	60	5.3	5.0
2A	2.5	65	1 ½" CLIP	60	18.8	2.6
2B	2.5	65	1 ½" CLIP	60	8.4	2.0
2C	2.5	65	1 ½" CLIP	60	11.2	3.7
2D	2.5	65	1 ½" CLIP	60	10.2	3.0
2AX	2.5	65	1 ½" CLIP	58	18.8	2.6
2BX	2.5	65	1 ½" CLIP	58	8.4	2.0
2DX	2.5	65	1 ½" CLIP	58	10.4	3.0

Sprayball Selection Chart

REF	HOLE (MM)	DIA (MM)	CONNECTION	H (MM)	FLOW (M3 / HR)	CLEANING RADIUS (M)
3A	2.5	65	¾" BSPF	45	13.2	1.3
3B	2.5	65	¾" BSPF	45	8.7	2.2
3C	2.5	65	¾" BSPF	45	9.2	2.2
3D	2.5	65	¾" BSPF	45	9.2	2.5
3A	1.6	65	¾" BSPF	45	6.3	1.7
3B	1.6	65	¾" BSPF	45	4.1	3.0
3C	1.6	65	¾" BSPF	45	4.4	3.4
3D	1.6	65	¾" BSPF	45	4.4	3.3
4A	1.6	50	1 ½" CLIP	53	6.6	1.9
4B	1.6	50	1 ½" CLIP	53	4.0	2.8
4C	1.6	50	1 ½" CLIP	53	3.7	2.3
4D	1.6	50	1 ½" CLIP	53	3.9	2.6
6A	2.5	65	1 ¼" CLIP	59	17.9	2.3
6B	2.5	65	1 ¼" CLIP	59	9.3	2.5
6C	2.5	65	1 ¼" CLIP	59	10.5	3.2
6D	2.5	65	1 ¼" CLIP	59	10.1	3.0
6AX	2.5	65	1 ¼" CLIP	56	17.9	2.3
6BX	2.5	65	1 ¼" CLIP	56	9.3	2.5
6DX	2.5	65	1 ¼" CLIP	56	10.1	3.0

Sprayball Selection Chart

REF	HOLE (MM)	DIA (MM)	CONNECTION	H (MM)	FLOW (M3 / HR)	CLEANING RADIUS (M)
6A	1.6	65	1 ¼" CLIP	59	7.8	2.7
6B	1.6	65	1 ¼" CLIP	59	4.2	3.1
6C	1.6	65	1 ¼" CLIP	59	4.3	3.3
6D	1.6	65	1 ¼" CLIP	59	4.3	3.2
7A	2.5	65	1 ½" CLIP	60	18.3	3.0
7B	2.5	65	1 ½" CLIP	60	8.1	2.4
7C	2.5	65	1 ½" CLIP	60	11.8	4.9
7D	2.5	65	1 ½" CLIP	60	10.4	3.9
8A	1.6	50	¾" CLIP	49	5.5	2.5
8B	1.6	50	¾" CLIP	49	3.4	3.8
8C	1.6	50	¾" CLIP	49	3.2	3.4
8D	1.6	50	¾" CLIP	49	3.5	4.1
8AX	1.6	50	¾" CLIP	46	5.5	2.5
8BX	1.6	50	¾" CLIP	46	3.4	3.8
8DX	1.6	50	¾" CLIP	46	3.5	4.1
9A	1.6	50	½" BSPF	49	5.4	2.4
9B	1.6	50	½" BSPF	49	3.0	3.0
9C	1.6	50	½" BSPF	49	3.1	3.2
9D	1.6	50	½" BSPF	49	3.3	3.6

Sprayball Selection Chart

REF	HOLE (MM)	DIA (MM)	CONNECTION	H (MM)	FLOW (M3 / HR)	CLEANING RADIUS (M)
10A	1.6	50	1" CLIP	52	7.2	4.3
10B	1.6	50	1" CLIP	52	4.7	7.2
10C	1.6	50	1" CLIP	52	4.7	7.2
10D	1.6	50	1" CLIP	52	4.5	6.7
10AX	1.6	50	1" CLIP	49	7.2	4.3
10BX	1.6	50	1" CLIP	49	4.7	7.2
10DX	1.6	50	1" CLIP	49	4.5	6.7
11A	2.5	90	1 ¼" BSPF	63	29.8	3.1
11B	2.5	90	1 ¼" BSPF	63	12.7	2.2
11C	2.5	90	1 ¼" BSPF	63	15.9	3.4
11D	2.5	90	1 ¼" BSPF	63	15.9	3.1
12A	2.5	90	1 ½" CLIP	75	3.5	4.1
12B	2.5	90	1 ½" CLIP	75	5.5	2.5
12C	2.5	90	1 ½" CLIP	75	3.4	3.8
12D	2.5	90	1 ½" CLIP	75	3.5	4.1
12AX	2.5	90	1 ½" CLIP	75	24.2	2.0
12BX	2.5	90	1 ½" CLIP	75	13.4	2.4
12DX	2.5	90	1 ½" CLIP	75	14.2	2.8

Sprayball Selection Chart

REF	HOLE (MM)	DIA (MM)	CONNECTION	H (MM)	FLOW (M3 / HR)	CLEANING RADIUS (M)
14A	2	120	2" CLIP	87	19.0	2.0
14B	2	120	2" CLIP	87	10.2	2.3
14C	2	120	2" CLIP	87	8.9	1.7
14D	2	120	2" CLIP	87	10.0	2.2
15A	1.6	40	¾" CLIP	44	3.7	3.8
15B	1.6	40	¾" CLIP	44	2.3	5.5
15C	1.6	40	¾" CLIP	44	2.3	5.9
15D	1.6	40	¾" CLIP	44	2.4	6.1
15AX	1.6	40	¾" CLIP	40	3.7	3.8
15BX	1.6	40	¾" CLIP	40	2.3	5.5
15DX	1.6	40	¾" CLIP	40	2.4	6.1
16A	1.3	40	¾" CLIP	44	5.1	4.7
16B	1.3	40	¾" CLIP	44	3.0	6.4
16C	1.3	40	¾" CLIP	44	3.1	7.0
16D	1.3	40	¾" CLIP	44	3.1	7.1
16AX	1.3	40	¾" CLIP	40	5.1	4.7
16BX	1.3	40	¾" CLIP	40	3.0	6.4
16DX	1.3	40	¾" CLIP	40	3.1	7.1

Sprayball Selection Chart

REF	HOLE (MM)	DIA (MM)	CONNECTION	H (MM)	FLOW (M3 / HR)	CLEANING RADIUS (M)
17A	1.3	28	¼" BSPF	23	1.8	1.0
17B	1.3	28	¼" BSPF	23	1.2	1.6
17C	1.3	28	¼" BSPF	23	1.4	2.2
17D	1.3	28	¼" BSPF	23	1.4	2.3
17AX	1.3	28	¼" BSPF	23	1.8	1.0
17BX	1.3	28	¼" BSPF	23	1.7	1.6
17DX	1.3	28	¼" BSPF	23	1.4	2.3

Other Tank Equipment

Adjustable Tank Feet Light Duty Adjustable Feet



Levelling system planned for Dairy, Pharmaceutical and Food industries, in respect of the strictest hygiene regulations. Brush provided with a gasket which, by adhering to the smooth surface of the screw avoids any dirt intrusion.

Base: Grey Polyamide

Screw: 304 Stainless Steel (316 on request)

Max Load: 3 tonnes

CODE	BASE DIAMETER (MM)	THREAD	STATIC LOAD (TON)
TFM20/15250	105	M20	2
TFM24/15251	105	M24	2
TFM20/15253	125	M20	3
TFM24/15254	125	M24	3
TFM30/15255	125	M30	3

Full dimensions and data sheet available on request

Hygienic Machine Feet

NGI THE XH SERIES

Normally the floor is the last place to be cleaned. If there are unhygienic deposits on the machine feet, there is a considerable risk that these will end up on the machine or system again due to the fact that high pressure cleaning is the most common way of cleaning floors. So, the first step is to ensure that the machine foot doesn't in itself constitute a hygienic risk.



How can fluid, food or powder residues be removed from a thread? Even more important, how can they be prevented from getting onto the thread in the first place?

Finding the answers to these questions through the innovative design of machine feet of uncompromising quality and reliability that also minimise the time needed for cleaning, is the core of NGI's hygiene philosophy.

How to ensure that machine feet are hygienic:

1. Use a foot with a 3A, EHEDG and USDA certificate
2. Use a foot with a spindle which is covered by a sleeve and sealed with O-rings at both ends
3. Use a foot with vulcanised rubber, which accommodates slopes on the floor and is designed to avoid capillary action
4. Use a foot made in Stainless Steel
5. Use a foot that will stand solidly and securely on the floor and will be able to absorb vibration
6. Use a foot with no unnecessary corners and edges; facilitates the cleaning process
7. Use an adjustable foot without an exposed thread

Other Tank Equipment

Medium Duty Adjustable Feet

Levelling system planned for Dairy, Pharmaceutical and Food industries, in respect of the strictest hygiene regulations. Round surface that avoids any dust and dirt deposit.

Brush provided with a gasket which, by adhering to the smooth surface of the screw, avoids any dirt intrusion.

Base: Grey Polyamide

Screw: 304 Stainless Steel (316 on request)

Max Load: 5 tonnes



CODE	BASE DIAMETER (MM)	THREAD	STATIC LOAD (TON)
TFM16/15298	75	M16	2
TFM16/15299	100	M16	3
TFM20/15300	100	M20	3
TFM24/15301	100	M24	3
TFM30/15302	100	M30	3
TFM20/15303	120	M20	4
TFM24/15304	120	M24	4
TFM30/15305	120	M30	4
TFM20/15306	150	M20	5
TFM24/15307	150	M24	5
TFM30/15308	150	M30	5

Full dimensions and data sheet available on request

Other Tank Equipment

Heavy Duty Aseptic Feet

Levelling system planned for Dairy, Pharmaceutical and Food industries, in respect of the strictest hygiene regulations. Round surface that avoids any dust and dirt deposit.

Brush provided with a gasket which, by adhering to the smooth surface of the screw, avoids any dirt intrusion.

Material: 304 Stainless Steel (316 on request)

Max Load: 20 tonnes



CODE	BASE DIAMETER (MM)	THREAD	STATIC LOAD (TON)
TFM75/16000	100	¾" G	7
TFM75/16002	120	¾" G	9
TFM125/16004	100	1 ¼" G	10
TFM125/16006	120	1 ¼" G	15
TFM125/16008	160	1 ¼" G	20

Full dimensions and data sheet available on request

Other Tank Equipment

Heavy Duty Hygienic Feet

Levelling system planned for Dairy, Pharmaceutical and Food industries, in respect of the strictest hygiene regulations. Round surface that avoids any dust and dirt deposit.

Material: 304 Stainless Steel (316 on request)

Max Load: 12 tonnes



CODE	BASE DIAMETER (MM)	THREAD	STATIC LOAD (TON)
TFM20/16010	80	M20	3.5
TFM24/16030	100	M24	7
TFM30/16031	120	M30	8
TFM40/16050	150	M40	12
TFM40/16051	200	M40	12

Full dimensions and data sheet available on request

Other Tank Equipment

Stainless Steel Stems, Plastic Bases

Stem: Stainless Steel (304)

Bases: Polypropylene white or black, conical or bolt down

Hole Centres: 80mm bases 55mm (8.5mm)
105mm bases 74 mm(11mm)

Spanner flats: 12mm stems = 10mm
20mm stems = 17mm

16mm stems = 13mm
24mm stems = 20mm

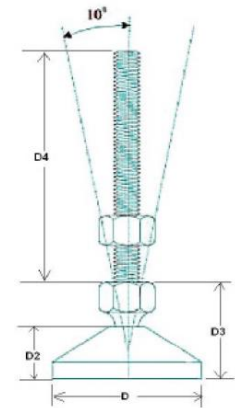

CODE	LOAD RATING (KG)	D	D1	D2	D3	D4
TFM10/75/50WP	200	50	10	19	38	75
TFM10/100/50WP	200	50	10	19	38	100
TFM12/100/80WP	300	80	12	25	41	123
TFM12/150/80WP	300	80	12	25	41	173
TFM16/150/80WP	800	80	16	25	42	170
TFM16/200/80WP	800	80	16	25	42	220
TFM16/250/80WP	800	80	16	25	42	270
TFM16/290/80WP	800	80	16	25	42	310
TFM20/150/80WP	800	80	20	25	44	170
TFM20/200/80WP	800	80	20	25	44	220
TFM20/250/80WP	800	80	20	25	44	270
TFM20/290/80WP	800	80	20	25	44	310
TFM20/350/80WP	800	80	20	25	44	370
TFM24/150/80WP	800	80	24	25	52	165
TFM24/200/80WP	800	80	24	25	52	215
TFM16/150/105WP	800	105	16	25	42	170
TFM16/200/105WP	800	105	16	25	42	220
TFM16/250/105WP	800	105	16	25	42	270
TFM16/290/105WP	800	105	16	25	42	310
TFM20/150/105WP	800	105	20	25	44	170
TFM20/200/105WP	800	105	20	25	44	220
TFM20/250/105WP	800	105	20	25	44	270
TFM20/350/105WP	800	105	20	25	44	370
TFM24/150/105WP	800	105	24	25	52	165
TFM24/200/105WP	800	105	24	25	52	215

Other Tank Equipment

Stainless Steel Stems, Stainless Bases

Stainless Steel (304)

Hole Centres: 102mm bases – 11mm holes at 74mm centre

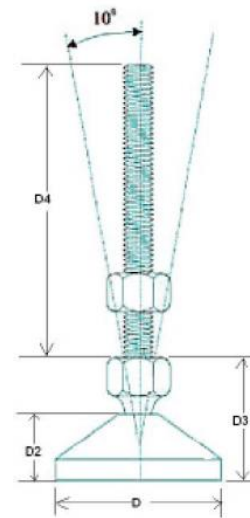

CODE	BASE TYPE	LOAD RATING (KG)	D	D1	D2	D3	D4
TFM8/25/38SC	CONICAL	300	38	8	14	31	25
TFM8/55/38SC	CONICAL	300	38	8	14	31	55
TFM10/35/38SC	CONICAL	300	38	10	14	31	35
TFM10/55/38SC	CONICAL	300	38	10	14	31	55
TFM10/75/38SC	CONICAL	300	38	10	14	31	75
TFM10/100/38SC	CONICAL	300	38	10	14	31	100
TFM12/100/51SC	CONICAL	500	51	12	15	38	150
TFM16/150/76SC	CONICAL	1500	76	16	22	50	150
TFM16/200/76SC	CONICAL	1500	76	16	22	50	200
TFM20/150/76SC	CONICAL	2000	76	20	22	55	150
TFM20/200/76SC	CONICAL	2000	76	20	22	55	200
TFM24/150/76SC	CONICAL	2000	76	24	22	54	150
TFM24/200/76SC	CONICAL	2000	76	24	22	54	200
TFM16/150/102SB	B/DOWN	1500	102	16	22	51	150
TFM16/200/102SB	B/DOWN	1500	102	16	22	51	200
TFM20/150/102SB	B/DOWN	2000	102	20	22	55	150
TFM20/200/102SB	B/DOWN	2000	102	20	22	55	200
TFM24/150/102SB	B/DOWN	2000	102	24	22	54	150
TFM24/200/102SB	B/DOWN	2000	102	24	22	54	200

Other Tank Equipment

Pressure Equalising Valve

High flow type HSV. Designed for vessel protection during fill/empty and during CIP.

Pressure: -2 bar to +4 bar

Discs are PTFE and seat seals are EPDM.

Available: 150-450mm



Pressure Equalising Valve

Dead Weight.

Designed for low pressure applications, this dead weight valve will open at a vacuum of 2m bar and a positive pressure of 100m bar (50m bar for 40mm model), the valve will be fully sealed at atmospheric pressure.

Discs are PTFE and seat seals are EPDM.

Available: 40 to 150mm in 316L Stainless Steel

Optional: Pressure settings, insect screen, collected exhaust.



Float Valve

Used to maintain a level in a tank. The Stainless Steel float rises with the liquid and closes off the valve on the feed line. As the liquid level falls the valve opens, thus maintaining a set level.

Available: 1" to 3" 304 stainless steel. Maximum 4 bar line pressure.

Optional: Splash screen.

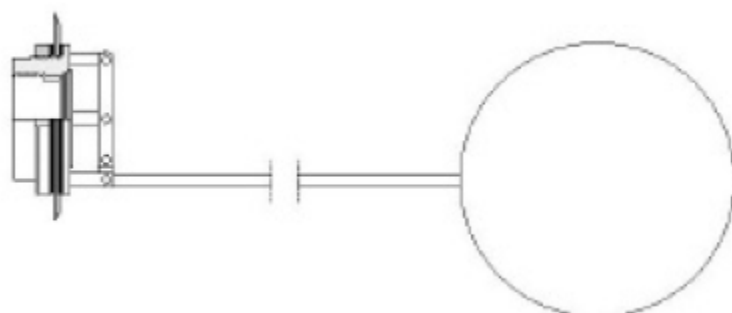

Other Tank Equipment

Pressure Relief Valves

Generally, overflow valves are non PED as the operation is not critical to the safety of the system. Where PED approval is required the valve is classed as a safety relief valve.

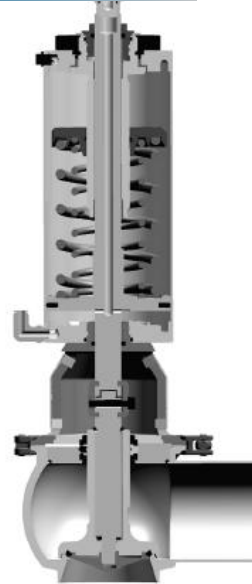

Tank Outlet Valves

Tank outlet valves are available in various patterns, single seat or double seat mix proof, from a number of manufacturers to suit the particular application. Please call to discuss your specific requirements.



Other Tank Equipment

Sampling Valve PEMS IV

316 Stainless Steel sampling valve, with 25mm weld process connection, 6mm plain outlet, simple lever plain outlet, simple lever operation. Options of 2 outlets for CIP and threaded outlets.



Sampling Valve PEMS II

316L sampling valve with replaceable rubber membrane and 6mm draw off. In addition to sealing the draw off, the membrane also seals off the working parts of the valve from the products.



Hypodermic Sample Point

304 with Silicon rubber membrane

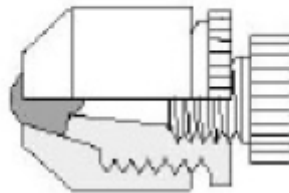

Aseptic Sampling Valve

The 316L Aseptic sampling valve can be sterilised before and after sampling, and, if required continuously between samples.

Available in three sizes and for tank pipe, clamp or socket mounting. Also with Knob or lever, for hand operation, or air actuator for pneumatic operation.



Manway Seals and Spares

As we supply Manways and Tank Equipment, we highly recommend purchasing a Seals and Spares kit as part of the purchase of a Manway Door. For more information, please contact our office on +44 (0)113 252 6712.

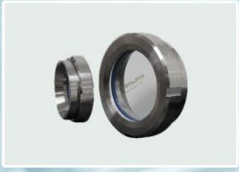

HpE Process Ltd deliver sustainable solutions to the following industries

- Adhesives
- Architectural
- Automotive
- Beverage
- Bio Chemicals
- Bio Tech
- Brewing
- Chemical
- Confectionery
- Dairy
- Food
- Household
- Paints and Coatings
- Paper
- Personal Care
- Pharmaceuticals
- Ready Meals
- Water



HpE Process Ltd
Unit N2, Gildersome Spur, Leeds, West Yorkshire, LS27 7JZ
Telephone: +44 (0)113 252 6712 Fax: +44(0)113 253 8125
Email: sales@hpeprocess.com www.hpeprocess.com