



Washroom Brochure





For more information on our HiZone full height cubicles see pages 12–13.



We believe well designed washrooms should be available to everyone.

Bushboard have been developing cubicle and washroom systems for over 80 years and our reputation has been built on delivering quality products at affordable prices.

We do this by combining innovative design with quality materials and fittings to deliver great style and great value. This straightforward approach means our tried and trusted ranges are specified time and time again.

Over 35,000 projects successfully completed nationwide:

15,500
Education projects

12,500
Commercial projects

5,000
Healthcare projects

2,500
Leisure projects

Exceptional products at exceptional prices.

Through our experience, we have perfected the art of delivering cost-effective washrooms without compromising on quality.

Attention to detail, in-built functionality, and the latest technology mean that we can deliver excellent value for money, every time.

It's simple. We work hard to develop great products at great prices so your washroom will work really hard for you.

Cost-effective, single order solutions.

Bushboard's Ready Plumbed Modules arrive on site with sanitaryware and brassware pre-fitted to panels which are pre-assembled to a rigid steel frame.

Bushboard work in partnership with SanCeram and a number of leading sanitaryware and brassware brands, meaning ordering your washroom from a single supplier has never been easier.

For your cost-effective, one order, one delivery option see page 41.



Bushboard's Ready Plumbed Modules save both time and money, offering a one supplier, one delivery option. For more information see page 43.

Service and support.

From initial planning through to installation, we work hard to make sure choosing the right washroom at the right price is as easy as possible.



Specification

From presenting CPDs to writing National Building Specifications (NBS) and assisting contractors, our UK-wide Specification Manager is always on hand to help.

All Bushboard products are available as BIM models, downloadable from the website www.bushboard-washrooms.co.uk



Estimating

Our quotations are designed to give you a clear and concise breakdown of products and costs.



CAD

You will be assigned a dedicated CAD technician who can draft drawings for approval prior to manufacture.



Delivery

All delivery costs are included within our price.*



Installation

Our UK-wide network of Preferred Installers are completely familiar with our washroom ranges and offer an exceptional service.



After Sales

Your dedicated contact in our friendly and efficient after sales team will guide you from order to delivery and beyond.



Guarantees

All of our manufactured products come with a 5 year guarantee.

* UK mainland only.

Choosing your washroom couldn't be simpler.

Whether you are driven by budget or design, our simple 3 step process will ensure that your washroom is perfectly suited to your individual requirements.

1 Choose your cubicle system, see pages 5 – 37

Our range of 14 cubicles are designed to deliver the perfect balance of quality and value by combining the very best in design with tried and trusted materials. See pages 26 – 35 for our range of education cubicles, specifically designed for children from nursery to university.

2 Choose your ducting, including sanitaryware and brassware, see pages 40 – 65

Our Ready Plumbed Modules (RPM) arrive on site with sanitaryware and brassware pre-fitted to panels and panels pre-assembled to a rigid aluminium frame. RPM is the best option for fast and cost-effective installation, or for increased flexibility you can supply and fit your own sanitaryware with our Ezeeduct or Panel Only options.

3 Choose your vanity system, including counter top, semi-recessed, cantilever or solid surface, see pages 66 – 73

We offer a number of smart, practical and hardwearing vanities to suit your needs. Our pre-plumbed vanities arrive on site with basins and taps, pre-fitted for quick and easy installation. Alternatively supply and fit your own sanitaryware with our Ezeevanity and Panel Only options.



For more information on **Definition™** **ColourCoat™** see pages 16 – 17.

CHOOSE YOUR CUBICLE SYSTEM

Bushboard cubicles are designed to deliver quality, durability and excellent value for money, down to the smallest detail.

Not only are our ranges exceptionally designed, they are also exceptionally easy to install and the final finish is always first class.

BASELINE™

Delivering our trademark quality and design at very affordable prices, Baseline comes in Bushboard's full 34 laminate colour options.

Baseline is finished with a sturdy satin anodised aluminium pedestal foot and headrail, ensuring it is robust enough to withstand the busiest of washroom environments.

Finish	Laminate
Performance	MFC HPL SGL
Pilasters	To match performance specification
Cubicle Hardware	Satin Anodised Aluminium with Light Grey ABS Lock
Standard Height	2100mm (overall height)
Floor Clearance	100mm
Colours	34 Laminate Options

Cross Section

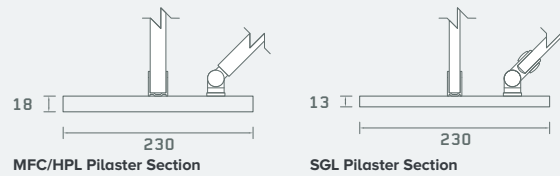

ABS Faceplate

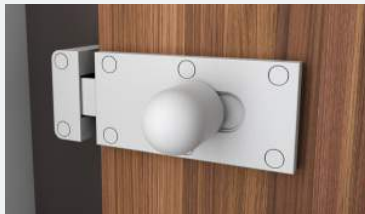

ABS Lock



Headrail



Pedestal Foot



For a full range of sanitaryware and brassware available ready plumbed to vanity units and duct panels, see page 46. For more information on our Ready Plumbed Modules, see page 41.



ABOVE – BASELINE™ STANDARD HEIGHT CUBICLES

Doors: American Walnut laminate | **Pilasters:** Slate Grey | **Fittings:** Satin Anodised Aluminium | **Vanity:** Semi-Recessed Vanity Unit and undervanity in Slate Grey with American Walnut laminate panels | **Basin:** Shenley 400 Slim Semi-Recessed Basin
Tap: SanCeram Deck Mounted Sensor Tap

HAVE YOU CONSIDERED?



**CHWB108 • SanCeram Chartham 450
Semi-Recessed Basin**



**SCBW119 • SanCeram Deck Mounted Sensor
Tap**



**CHWC102 • SanCeram Chartham Back to
Wall WC**

PROFILES™

Robust and hardwearing, Profiles is not only our best selling washroom cubicle, but also our most versatile.

Developed to be flexible enough to meet the demands of most environments and economical enough to meet most budgets, Profiles is so adaptable. Specify as we have shown here or choose the Profiles Kids™ children's cubicle with fun shaped doors, see pages 32 – 33. Profiles can also be specified with a curtain rail for shower cubicles or with integral cubicle benching for changing cubicles.

Finish	Laminate
Performance	MFC HPL SGL
Pilasters	To match performance specification
Cubicle Hardware	Satin Anodised Aluminium with Light Grey ABS Lock
Standard Height	2140mm (overall height)
Floor Clearance	100mm
Colours	34 Laminate Options

Cross Section

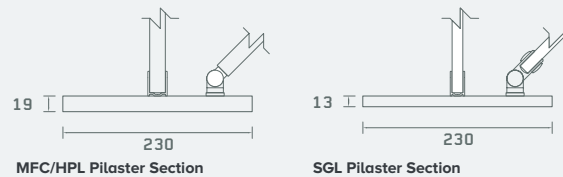

ABS Faceplate



ABS Lock



Headrail



Pedestal Foot



For a full range of sanitaryware and brassware available ready plumbed to vanity units and duct panels, see page 46. For more information on our Ready Plumbed Modules, see page 41.



ABOVE – PROFILES™ STANDARD HEIGHT CUBICLES

Doors: Cobalt Blue | **Pilasters:** Lime Green | **Fittings:** Silver | **Vanity:** Counter Top Vanity Unit in Cobalt Blue with Lime Green undervanity and Cobalt panels | **Basin:** Shenley 500 Counter Top Basin | **Tap:** Langley Mono Basin Mixer Tap

HAVE YOU CONSIDERED?



CHWB108 • SanCeram Chartham 450
Semi-Recessed Basin



SCBW124 • SanCeram Contemporary Press
Action taps



CHWC102 • SanCeram Chartham Back to
Wall WC

QUADRO™

Competitively priced and offering functional style, Quadro is a universal solution, ideal for any washroom environment.

The distinctive quadrant foot and headrail deliver strength and style, whilst optional aluminium Powder Coated privacy skirting delivers additional privacy. Quadro™ is the perfect choice for most sectors.

Finish	Laminate
Performance	MFC HPL SGL
Pilasters	To match performance specification
Cubicle Hardware	Satin Anodised Aluminium with Light Grey ABS Lock
Standard Height	2140mm (overall height)
Floor Clearance	Standard: 100mm With privacy skirting – Door: 50mm, Partition: To the floor
Colours	34 Laminate Options

Cross Section

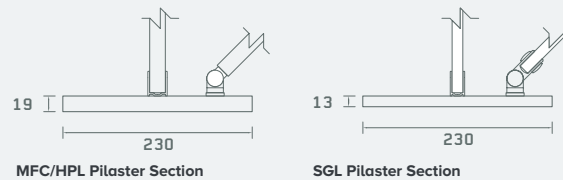

ABS Faceplate

ABS Lock

Headrail

Pilaster Foot

For a full range of sanitaryware and brassware available ready plumbed to vanity units and duct panels, see page 46. For more information on our Ready Plumbed Modules, see page 41.





ABOVE – QUADRO™ STANDARD HEIGHT CUBICLES

Doors: Lime Green | **Pilasters:** Mid Grey | **Fittings:** Satin Anodised Aluminium | **Vanity:** Counter Top Vanity Unit in Mid Grey with Mid Grey undervanity and Lime Green panels | **Basin:** Shenley 500 Counter Top Basin | **Tap:** Langley Mono Basin Mixer Tap

HAVE YOU CONSIDERED?



CHWB112 • SanCeram Chartham 530 Counter Top Basin



SCBW101 • SanCeram Chartham Mono Basin Mixer Tap



CHWC101 • SanCeram Chartham Wall Hung WC

HIZONE™

We developed our HiZone as the perfect solution to the ever-growing demand for privacy in the washroom.

These full height cubicles are finished at ground level with Satin Anodised Aluminium privacy skirting and at ceiling level with a matching Satin Anodised Aluminium headrail. HiZone is available with a full height door or door and overpanel, great for offices and commercial washrooms where privacy is desirable. For our HiZone for Schools higher education cubicle, see page 36 – 37.

Finish	Laminate
Performance	MFC HPL SGL
Pilasters	To match performance specification
Cubicle Hardware	Satin Anodised Aluminium with Light Grey ABS Lock
Overall Height	Maximum: 2770mm
Ceiling Clearance	Minimum: 10mm
Floor Clearance	Door: 5mm Partition: to the floor (with privacy skirting)
Colours	34 Laminate Options

Cross Section

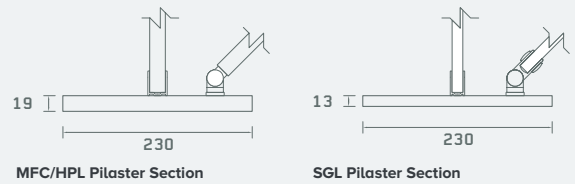

ABS Faceplate

ABS Lock

Headrail

Pilaster Foot

For a full range of sanitaryware and brassware available ready plumbed to vanity units and duct panels, see page 46. For more information on our Ready Plumbed Modules, see page 41.





ABOVE – HIZONE™ CUBICLES WITH FULL HEIGHT DOORS

Doors: Air Force Blue | **Pilasters:** Navy Blue | **Fittings:** Satin Anodised Aluminium | **Vanity:** Counter Top Vanity Unit in Air Force Blue with Navy Blue undervanity and Air Force Blue panels | **Basin:** Shenley 500 Counter Top Basin | **Tap:** Langley Mono Basin Mixer Tap

HAVE YOU CONSIDERED?



SHWB103 • SanCeram **Shenley 500 Counter Top Basin**



MDBW101 • SanCeram **Marden Mono Basin Mixer Tap**



MDWC102 • SanCeram **Marden Back to Wall WC**

DEFINITION™

Precise design and stunning hardware achieve a high end finish at an exceptional price. This flush-fronted toilet cubicle is nothing short of flawless.

Available in HPL and SGL in a choice of 34 laminate colours, the Definition flush-fronted toilet cubicle will add the wow-factor to any washroom. Definition is also available in ColourCoat™, see pages 16 – 17.

Finish	Laminate
Performance	HPL SGL
Fittings	Stainless Steel Thumb turn mortise lock*
Standard Height	HPL: 2020mm (plus floor clearance) SGL: 2015mm (plus floor clearance) Bespoke heights up to 2770mm available
Floor Clearance	20mm 100mm
Ceiling Clearance	Minimum 20mm
Headrail	Satin Anodised Aluminium
Colours	34 Laminate Options 10 ColourCoat™ colours

Cross Section

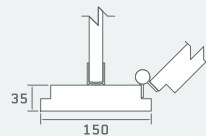

MFC/HPL Pilaster Section

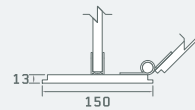

SGL Pilaster Section



Faceplate



Lock



Headrail Endcap



Pedestal Foot

For a full range of sanitaryware and brassware available ready plumbed to vanity units and duct panels, see page 46. For more information on our Ready Plumbed Modules, see page 41. *For solid grade laminate a face fixed stainless steel lock will be supplied.





ABOVE – DEFINITION™ FULL HEIGHT CUBICLES

Doors: Whitewashed Thatch laminate | **Pilasters:** Whitewashed Thatch laminate | **Fittings:** Stainless Steel
Vanity: Solid Surface Washtrough in Elysian | **Tap:** Langley Mono Basin Mixer tap

HAVE YOU CONSIDERED?



**MDWB112 • SanCeram Marden Square
Sit on Basin**



**LLBW106 • SanCeram Langley Mono Basin
Mixer Tap**



MDWC101 • SanCeram Marden Wall Hung WC

DEFINITION™ COLOURCOAT™

Definition ColourCoat is available in 10 striking colours ranging from bright and bold to contemporary monochrome. The doors, panels and pilasters all consist of a high performance MDF core, first primed before being sprayed with our pigmented lacquer and finished to either standard or high gloss.

Definition is also available in HPL and SGL in a choice of 34 laminate colours, see pages 14 – 15.

Finish	ColourCoat™
Performance	High Performance MDF
Fittings	Stainless Steel Thumb turn mortise lock*
Standard Height	2020mm (overall height) Bespoke heights up to 2770mm available
Floor Clearance	20mm 100mm
Ceiling Clearance	Minimum 20mm
Headrail	Satin Anodised Aluminium
Colours	10 ColourCoat™ colours

Cross Section

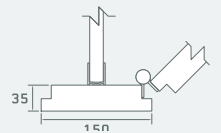

ColourCoat™ Pilaster Section



Faceplate



Lock



Headrail Endcap



Pedestal Foot

For a full range of sanitaryware and brassware available ready plumbed to vanity units and duct panels, see page 46. For more information on our Ready Plumbed Modules, see page 41. *For solid grade laminate a face fixed stainless steel lock will be supplied.





HAVE YOU CONSIDERED?



OV10000 • Solid Surface Integral Basin



HABW101 • SanCeram Hartley Mono Basin Mixer Tap



LLWC102 • SanCeram Langley Back to Wall WC

ABOVE – DEFINITION™ FULL HEIGHT CUBICLES

Doors: ColourCoat™ in Green | **Pilasters:** ColourCoat™ in Green | **Fittings:** Stainless Steel
Vanity: Solid Surface Washthrough in Elysian | **Tap:** Langley Mono Basin Mixer tap

PARALINE™

Simple, sleek and modern. Paraline's beautifully crafted streamlined pilasters and headrail bring you a truly contemporary washroom system that is solid, strong and ultra stylish.

The crisp, clean extruded aluminium pilasters and headrail bring you the optimum in washroom cubicles. Supplied with durable ABS lock and powder coated aluminium legs as standard. Stainless Steel options available.

Finish	Laminate Real Wood Veneer
Performance	MFC HPL SGL Real Wood Veneer*
Fittings	Light Grey** Stainless Steel
Standard Height	2025mm (includes 100mm floor clearance) Bespoke heights up to 2770mm available
Floor Clearance	Standard: 100mm Bespoke: 20mm
Ceiling Clearance	Standard and Bespoke height: Minimum 150mm Floor to ceiling: 30mm***
Pilasters & Headrail	Light Grey Powder Coated Aluminium Light Grey
Colours	34 Laminate Options 11 FSC® certified Real Wood Veneers

Cross Section

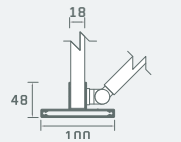

MFC/HPL/Real Wood Veneer Pilaster Section

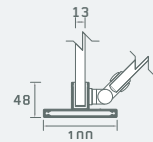

SGL Pilaster Section



The mark of responsible forestry



Stainless Steel Faceplate



Stainless Steel Lock Body



Headrail



Stainless Steel Pedestal Foot

For a full range of sanitaryware and brassware available ready plumbed to vanity units and duct panels, see page 46. For more information on our Ready Plumbed Modules, see page 41. * Real Wood Veneer option features an MDF core. ** For Light Grey lock and leg, as shown in main image, refer to Profiles detailed images on page 8. *** Structural ceilings are required for floor to ceiling. Suspended ceilings require a headrail. For floor to ceiling Paraline™, specify without a headrail. On floor to ceiling option, pilasters are fixed direct to ceiling, the 30mm clearance applies to doors only.





HAVE YOU CONSIDERED?



MDWB113 • SanCeram Marden Square Semi-Recessed Basin



MDBW101 • SanCeram Marden Mono Basin Mixer Tap



MDWC102 • SanCeram Marden Back to Wall WC

ABOVE – PARALINE PURE™ STANDARD HEIGHT CUBICLES

Doors: Wenge laminate | **Pilasters:** Aluminium in a Powder Coated Finish | **Fittings:** Light Grey | **Vanity:** Solid Surface Semi-Recessed Vanity Unit in Basalt with Pale Grey undervanity and Wenge laminate panels | **Basin:** Marden Square Semi-Recessed Basin | **Tap:** Marden Mono Basin Mixer Tap

AERO™

Aero's iconic curved aluminium floor mounted pilasters and matching headrail blend style and strength to deliver a beautifully smart and distinguished cubicle system.

Effortlessly sophisticated with Powder Coated pilasters and headrail, enhanced by elegant but durable ABS locks. For a striking combination choose Stainless Steel locks.

Finish	Laminate Real Wood Veneer
Performance	MFC HPL SGL Real Wood Veneer*
Fittings	Light Grey Stainless Steel**
Standard Height	2020mm (includes 100mm floor clearance) Floor to ceiling Bespoke heights available
Floor Clearance	Standard: 100mm Bespoke Height or Floor to Ceiling: 20mm
Ceiling Clearance	Standard and Bespoke height: Minimum 150mm Floor to ceiling: 30mm***
Pilasters & Headrail	Light Grey Powder Coated Aluminium Light Grey
Colours	34 Laminate Options 11 FSC® certified Real Wood Veneers

Cross Section

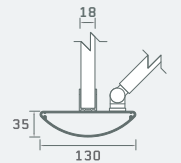

MFC/HPL/Real Wood Veneer Pilaster Section

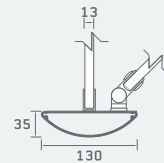

SGL Pilaster Section



The mark of responsible forestry



Light Grey Faceplate



Light Grey Lock Body



Headrail



Pilaster Foot

For a full range of sanitaryware and brassware available ready plumbed to vanity units and duct panels, see page 46. For more information on our Ready Plumbed Modules, see page 41. * Real Wood Veneer option features an MDF core. ** For Stainless Steel fittings, as shown in full scene, refer to Pardline detailed images on page 18. *** Structural ceilings are required for floor to ceiling. Suspended ceilings require a headrail. For floor to ceiling Aero™, specify without a headrail. On floor to ceiling option, pilasters are fixed direct to ceiling, the 30mm clearance applies to doors only.





ABOVE – AERO™ FULL HEIGHT CUBICLES

Doors: Deep Purple | **Pilasters:** Light Grey | **Fittings:** Stainless Steel | **Vanity:** Solid Surface Counter Top Vanity Unit in Elysian with Deep Purple undervanity and laminate panels | **Basin:** Langley Vessel Basin | **Tap:** Langley Tall Mono Basin Mixer Tap

HAVE YOU CONSIDERED?



LLBW108 • SanCeram **Langley Vessel Basin**



HABW102N • SanCeram **Hartley Tall Mono Basin Mixer Tap, Brushed Nickel**



MDWC101 • SanCeram **Marden Wall Hung WC**

MANHATTAN™

Take your washroom to the next level with our luxury flush-fronted cubicle. Manhattan offers a sophisticated and superior look with high quality fittings and sleek design.

Flush-fronted 44mm doors and pilasters, faced with a choice of stunning FSC® veneer or high pressure laminate and lipped to match. Luxury washrooms don't get any better than this.

Finish	Laminate Veneer
Performance	MDF Core Exact Match Lipping
Doors and Pilasters	44mm
Partitions	18mm
Fittings	Satin Anodised Aluminium fittings Thumb Turn Mortice Lock
Standard Height	2020mm (overall height) Bespoke heights available
Door Clearance	Standard height: 50mm Bespoke/Full height: 10mm Partition: To the floor with 50mm privacy skirting
Ceiling Clearance	Minimum 30mm
Colours	34 Laminate Options 11 FSC® certified Real Wood Veneers

Cross Section

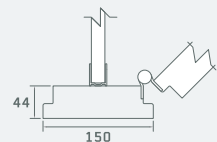

HPL/Veneer Pilaster Section



The mark of responsible forestry



Thumb Turn Mortice Lock



Faceplate



Cubicle Hinge



Privacy Skirting

For a full range of sanitaryware and brassware available ready plumbed to vanity units and duct panels, see page 46. For more information on our Ready Plumbed Modules, see page 41.





HAVE YOU CONSIDERED?



HAWB101 • SanCeram **Hartley Oval Vessel Basin**



HABW102 • SanCeram **Hartley Tall Mono Basin Mixer Tap, Chrome**



LLWC101 • SanCeram **Langley Wall hung WC**

ABOVE – MANHATTAN™ FULL HEIGHT CUBICLES

Doors: European Oak Real Wood Veneer | **Pilasters:** European Oak Real Wood Veneer |

Fittings: Satin Anodised Aluminium | **Vanity:** Solid Surface Cantilever Vanity Unit in Elysian | **Basin:** Hartley Oval Vessel Basin |

Tap: Hartley Tall Mono Basin Mixer Tap

MANHATTAN™ COLOURCOAT™

Take your washroom to the next level with our luxury flush-fronted cubicle. Manhattan offers a sophisticated and superior look with high quality fittings and sleek design.

The world is your oyster with Manhattan ColourCoat. Benefit from Manhattan's luxurious flush fronted 44mm doors and pilasters, finished in a flawless ColourCoat pigmented lacquer in any RAL colour you choose. Luxury washrooms don't get any better than this.

Finish	ColourCoat™ ColourCoat™ High Gloss
Performance	High Performance MDF
Doors and Pilasters	44mm
Partitions	18mm
Fittings	Satin Anodised Aluminium fittings Thumb Turn Mortice Lock
Standard Height	2020mm (overall height) Bespoke heights available
Door Clearance	Standard height: 50mm Bespoke/Full height: 10mm Partition: To the floor with 50mm privacy skirting
Ceiling Clearance	Minimum 30mm
Colours	Any RAL ColourCoat™ (standard or high gloss)

Cross Section

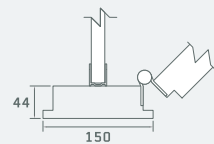

ColourCoat™ Pilaster Section



Thumb Turn Mortice Lock



Faceplate



Cubicle Hinge



Privacy Skirting

For a full range of sanitaryware and brassware available ready plumbed to vanity units and duct panels, see page 46. For more information on our Ready Plumbed Modules, see page 41.





ABOVE – MANHATTAN™ FULL HEIGHT CUBICLES

Doors: ColourCoat™ High Gloss in Black | **Pilasters:** ColourCoat™ High Gloss in Black |

Fittings: Satin Anodised Aluminium | **Vanity:** Solid Surface Cantilever Vanity Unit in Elysian | **Basin:** Hartley Oval Vessel Basin |

Tap: Hartley Tall Mono Basin Mixer Tap

HAVE YOU CONSIDERED?



LLWB108 • SanCeram Langley Vessel Basin



LLBW105 • SanCeram Langley Tall Mono Basin Mixer Tap



LLWC101 • SanCeram Langley Wall Hung WC

Education washrooms, from nursery to university.

With stunning colour options, including 3 exciting laminate prints with shaped pilasters and doors, designing washrooms has never been so much fun!

Children want welcoming washrooms that are bright, clean and safe. Colour plays a vital role in achieving great washroom design and kids just love experimenting with our colour range and unique laminate prints.



Jumble Blocks

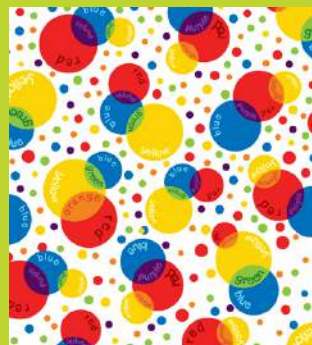

Colour Creations



Hand Prints

Next Day Laminate Sample Service

Our 15cm x 15cm laminate samples are a must when deciding on your colour scheme.

Delivered in as little as just 24 hours you can order online by visiting www.bushboard-washrooms.co.uk or call 01536 533 620.



Hand Prints

"I like the bright hand colours"

Maggie, aged 4

Colour Creations

"The circles are nice and bright and good for art as it shows how to make other colours"

Tara, aged 7

Jumble Blocks

"I love this because it's so colourful, all mixed up and fun to look at!"

Joseph, aged 7

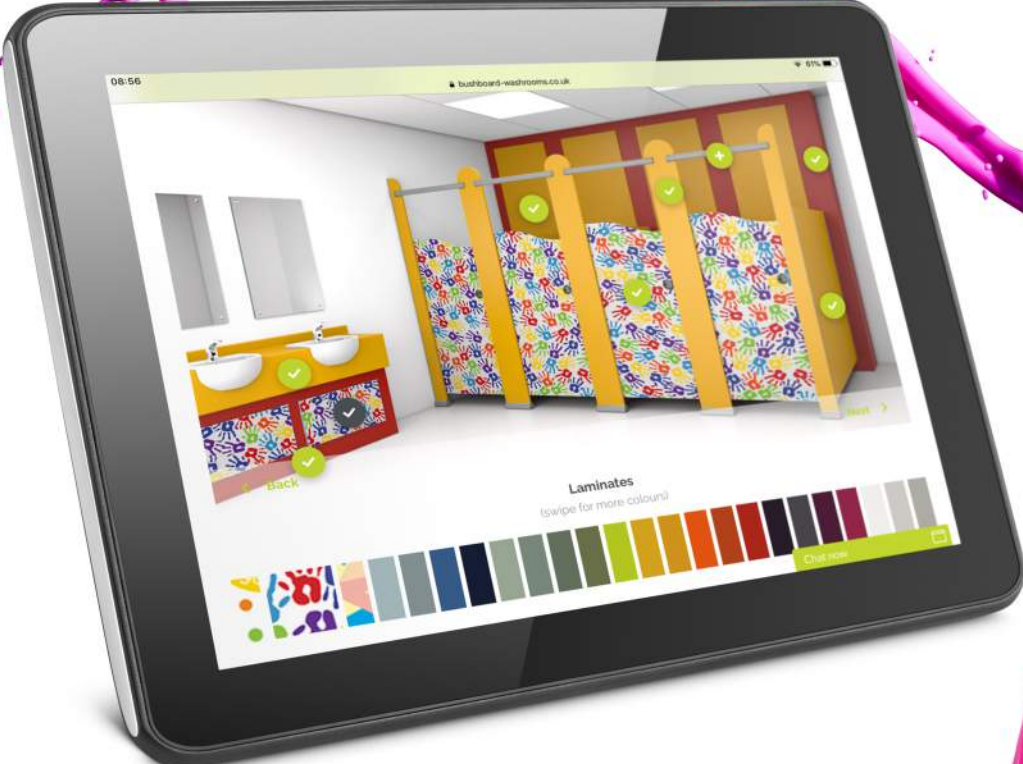

Over 15,000
education establishments
nationwide have trusted
us with their washrooms,
including:

- Nurseries & Pre-Schools
- Primary Schools
- Secondary Schools
- Colleges
- Universities

Experiment with colour! Our online Design Tool makes choosing your own unique washroom as easy as 1, 2, 3!

- 1.** Start by visiting www.bushboard-washrooms.co.uk and select the Design Tool option.
- 2.** Add your favourite colours at the touch of a button.
- 3.** Once you are happy with your chosen colour scheme, save, share and print your design.



TINY STUFF™

Designed specifically for Early Years in two height options, Tiny Stuff is a fun, safe and reliable cubicle secured with sturdy floor and wall channels for stability.

Tiny Stuff features floor-mounted pilasters and sturdy wall fixings to ensure robustness, anti-finger-trap hinges for added safety and low height doors with no headrail for easy supervision. Tiny Stuff has shaped doors and pilasters which are so much fun!

Finish	Laminate
Performance	MFC HPL SGL
Pilasters and Doors	Crescent pilaster with curvy door Arrowhead pilaster with angle door To match performance specification
Fittings	Light Grey Powder Coated Aluminium with Light Grey ABS Locks
Hinges	Anti-finger-trap as standard
Door Heights	1050mm 1250mm to top of door/partition (including floor clearance)
Floor Clearance	100mm
Headrail	No headrail for easy access and supervision
Colours	34 Laminate Options 3 digital prints (HPL only)

Cross Section

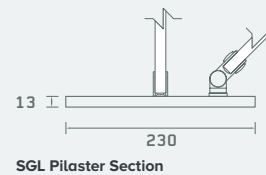
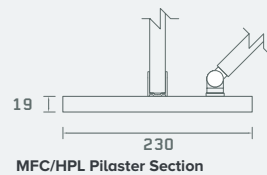

ABS Faceplate

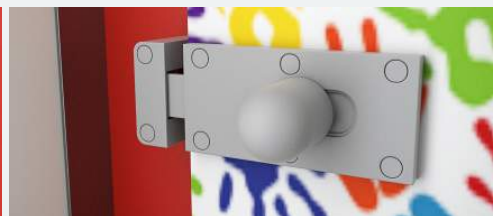

ABS Lock



Pilaster Foot

For a full range of sanitaryware and brassware available ready plumbed to vanity units and duct panels, see page 46. For more information on our Ready Plumbed Modules, see page 41.





HAVE YOU CONSIDERED?



SHWB105 • SanCeram Shenley 400 Slim Semi-Recessed Basin



SCBW119 • SanCeram Deck Mounted Sensor Tap



SHWC101 • SanCeram Shenley School 350 Lower Height WC

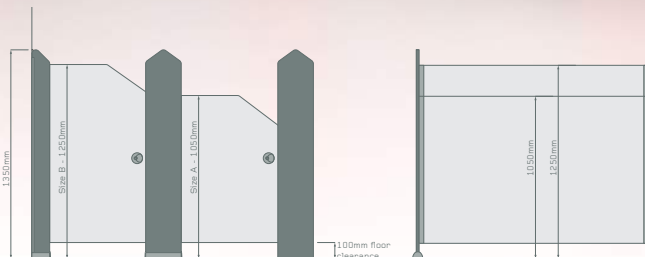

ABOVE – TINY STUFF™ CUBICLES

Doors: Hand Prints | **Pilasters:** Bright Red | **Fittings:** Light Grey | **Vanity:** Semi-Recessed Vanity Unit and undervanity in Bright Red with Hand Prints panels | **Basin:** Shenley 400 Slim Semi-Recessed Basin | **Tap:** SanCeram Deck Mounted Sensor Tap

KIDS STUFF™

Developed in two height options, Kids Stuff is a dependable children's toilet cubicle that is safe and fun.

Featuring anti-finger-trap safety hinges and two cubicle heights to offer growing children appropriate levels of privacy, Kids Stuff is perfect for ensuring safety in Primary School toilets. Finished at floor level with sturdy floor fixed pilasters.

Finish	Laminate
Performance	MFC HPL SGL
Pilasters and Doors	Crescent pilaster with curvy door Arrowhead pilaster with angle door To match performance specification
Cubicle Hardware	Light Grey Powder Coated Aluminium with Light Grey ABS Locks
Hinges	Anti-finger-trap as standard
Door Heights	1300mm 1650mm to top of door/partition (including floor clearance)
Floor Clearance	100mm
Colours	34 Laminate Options 3 digital prints (HPL only)

Cross Section

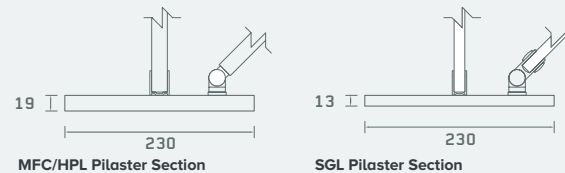

ABS Faceplate

ABS Lock

Headrail

Pilaster Foot

For a full range of sanitaryware and brassware available ready plumbed to vanity units and duct panels, see page 46. For more information on our Ready Plumbed Modules, see page 41.



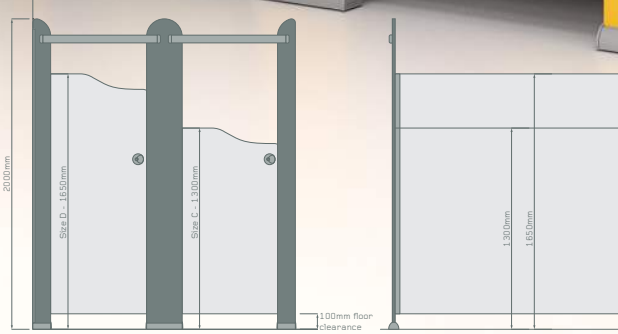

ABOVE – KIDS STUFF™ CUBICLES

Doors: Colour Creations | **Pilasters:** Mustard Yellow | **Fittings:** Light Grey | **Vanity:** Semi-
 Recessed Vanity Unit and undervanity in Mustard Yellow with Colour Creations panels |
Basin: Shenley 400 Slim Semi-Recessed Basin | **Tap:** SanCeram Deck Mounted Sensor Tap

HAVE YOU CONSIDERED?



SHWB105 • SanCeram Shenley 400 Slim Semi-Recessed Basin



SCBW106 • SanCeram Self Closing Mixer Tap



SHWC101 • SanCeram Shenley School 350 Lower Height WC

PROFILES KIDS™

Profiles is our most versatile toilet cubicle; flexible enough to suit all ages, economical enough to suit all budgets.

Profiles Kids can be specified for younger children with shaped doors allowing easy access and supervision. For Primary and Secondary Schools, Colleges, Universities and staff areas, the standard height Profiles cubicle is a perfect option, see pages 8 – 9.

Finish	Laminate
Performance	MFC HPL SGL
Pilasters and Doors	Crescent Arrowhead Square To match performance specification
Cubicle Hardware	Satin Anodised Aluminium with Light Grey ABS Lock
Hinges	Anti-finger-trap as standard
Door Heights	1100mm 1300mm 1500mm to lowest point on door scallop (including floor clearance)
Floor Clearance	100mm
Colours	34 Laminate Options 3 digital prints (HPL only)

Cross Section

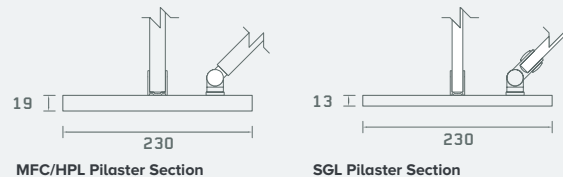

ABS Faceplate



ABS Lock



Headrail



Pedestal Foot

For a full range of sanitaryware and brassware available ready plumbed to vanity units and duct panels, see page 46. For more information on our Ready Plumbed Modules, see page 41.





HAVE YOU CONSIDERED?



SHWB105 • SanCeram **Shenley 400 Slim**
Semi-Recessed Basin



SCBW119 • SanCeram **Deck Mounted Sensor**
Tap



CHWC102 • SanCeram **Chartham Back to**
Wall WC

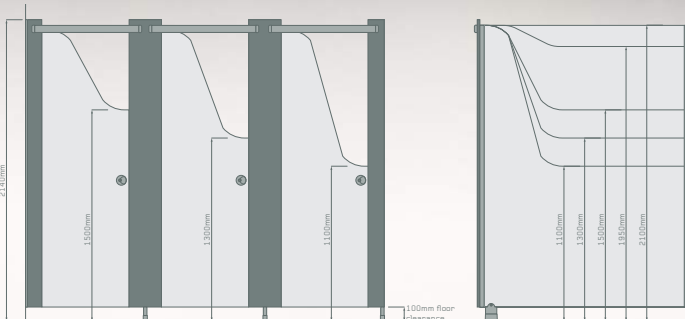

ABOVE – PROFILE KIDS™ CUBICLES DOORS 1000MM HIGH

Doors: Jumble Blocks | **Pilasters:** Cobalt Blue | **Fittings:** Satin Anodised Aluminium
Vanity: Semi-Recessed Vanity Unit in Lime Green with Cobalt Blue undervanity
and Jumble Blocks panels | **Basin:** Shenley 400 Slim Semi-Recessed Basin | **Tap:**
SanCeram Deck Mounted Sensor Tap

TOUGH STUFF™

Tough Stuff is exactly that; a durable, robust cubicle range developed for demanding environments. Ideal for Primary Schools, Secondary Schools or staff areas as toilet, shower or changing cubicles.

Tough Stuff features sturdy floor and wall fixing channels for stability, Powder Coated aluminium hardware and polycarbonate locking mechanism for durability and a through-fixed headrail for strength.

Finish	Laminate
Performance	MFC HPL SGL
Pilasters and Doors	To match performance specification
Cubicle Hardware	Light Grey Powder Coated Aluminium with Light Grey ABS Locks
Hinges	Anti-finger-trap as standard
Standard Height	2000mm* (overall height)
Floor Clearance	100mm
Colours	34 Laminate Options 3 digital prints (HPL only)

Cross Section

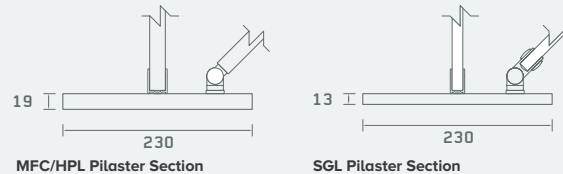

ABS Faceplate



ABS Lock



Headrail

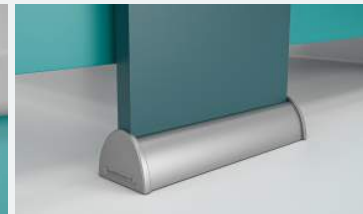

Pilaster Foot



For a full range of sanitaryware and brassware available ready plumbed to vanity units and duct panels, see page 46. For more information on our Ready Plumbed Modules, see page 41. * To top of division, plus 40mm to top of the pilaster.



ABOVE – TOUGH STUFF™ STANDARD HEIGHT CUBICLES

Doors: Turquoise | **Pilasters:** Ocean Green | **Fittings:** Light Grey | **Vanity:** Semi-Recessed Vanity Unit in Turquoise with Ocean Blue undervanity and Turquoise panels | **Basin:** Shenley 400 Slim Semi-Recessed Basin | **Tap:** SanCeram Deck Mounted Sensor Tap

HAVE YOU CONSIDERED?



**CHWB108 • SanCeram Chartham 450
Semi-Recessed Basin**



**SCBW119 • SanCeram Deck Mounted Sensor
Tap**



**CHWC102 • SanCeram Chartham Back to
Wall WC**

HIZONE™ FOR SCHOOLS

We developed HiZone for Schools in response to Department for Education regulations. The requirements for added privacy are at the forefront of this higher education toilet cubicle.

These full height cubicles are finished at ground level with satin anodised privacy skirting and a 5mm door clearance. Featuring a privacy strip to limit the gap between the door and the hinge to 5mm to discourage anti-social behaviour such as use of mobile phone cameras. HiZone is available with a door and overpanel or a full height door, see page 12 – 13; great for offices and commercial washrooms.

Finish	Laminate
Performance	HPL SGL
Pilasters	To match performance specification
Fittings	Satin Anodised Aluminium with Hex Key Emergency Release Lock
Overall Height	Maximum: 2770mm
Ceiling Clearance	Minimum: 10mm
Floor Clearance	Door: 5mm Partition: to the floor (with privacy skirting)
Headrail	Satin Anodised Aluminium
Colours	34 Laminate Options

Cross Section

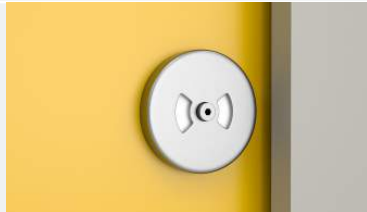
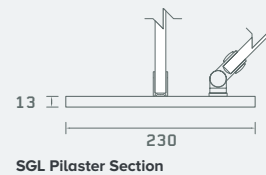
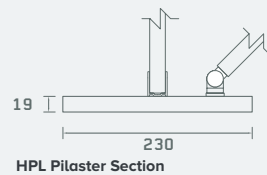

Satin Anodised Aluminium Faceplate with Hex Key Emergency Release



Satin Anodised Aluminium Lock



Headrail



Pilaster Foot

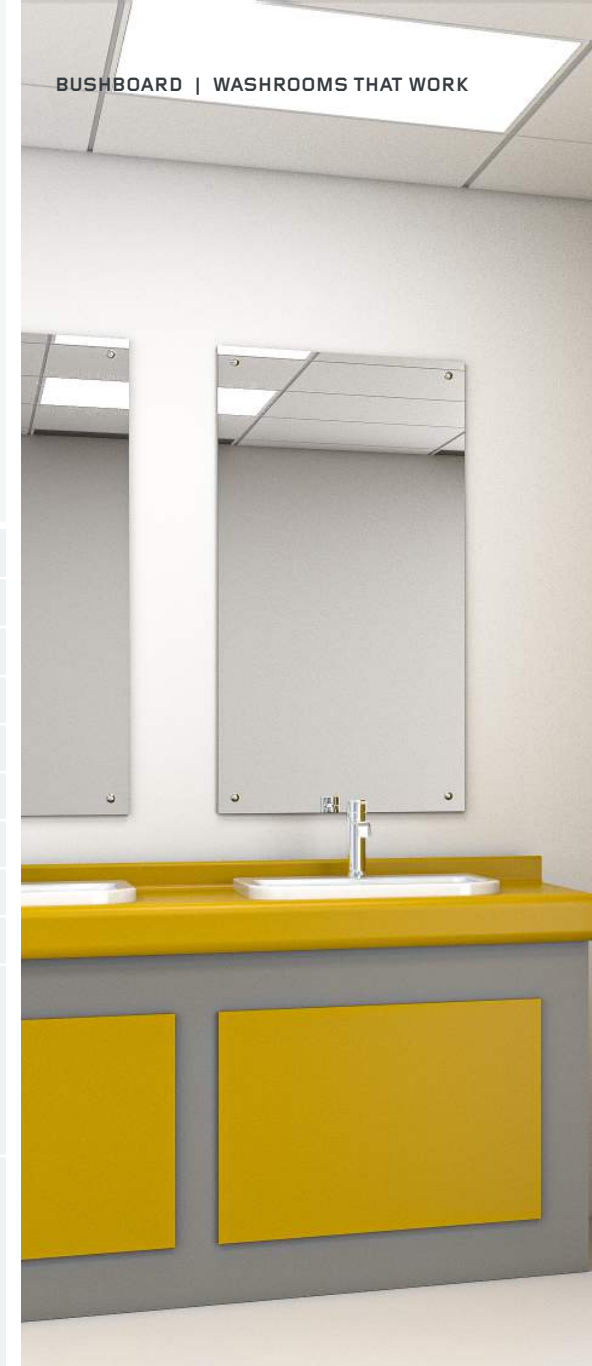

For a full range of sanitaryware and brassware available ready plumbed to vanity units and duct panels, see page 46. For more information on our Ready Plumbed Modules, see page 41.



ABOVE – HIZONE™ FOR SCHOOLS CUBICLE

Doors: Sunshine Yellow | **Pilasters:** Mid Grey | **Fittings:** Satin Anodised Aluminium | **Vanity:** Counter Top Vanity Unit in Sunshine Yellow with Mid Grey undervanity and Sunshine Yellow panels | **Basin:** Shenley 500 Counter Top Basin | **Tap:** Langley Mono Basin Mixer Tap

HAVE YOU CONSIDERED?



SHWB103 • SanCeram **Shenley 500 Counter Top Basin**



LLBW104 • SanCeram **Langley Mono Basin Mixer Tap**



MDWC102 • SanCeram **Marden Back to Wall WC**

Cubicle Elements and Configurations

Our team of advisors are happy to offer advice and guidance on your project. On the following pages we have shown the key elements of a typical cubicle and some layout configurations to make it easy for you to discuss your project with us.

You can also download these drawings from our website www.bushboard-washrooms.co.uk

Typical Cubicle

- 01 Continuous wall channel
- 02 Headrail
- 03 Wall end pilaster
- 04 Inter pilaster
- 05 Hinges
- 06 Door
- 07 Partition



Typical cubicle configurations

- 09 Between walls
- 10 Against walls
- 11 Oversized between walls
- 12 Oversized against walls

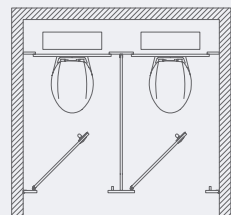

9

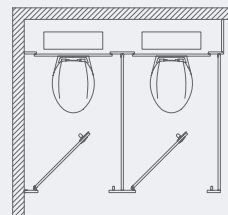

10

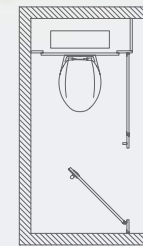

11

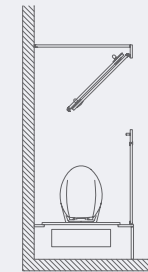

12

Equality Act 2010

All Bushboard cubicles can be delivered to comply with Building Regulations Part M and the Equality Act 2010*. We can help you with planning your washroom and the issues you need to consider.

Enlarged

Where four or more cubicles are provided in a washroom one of these must be enlarged. Enlarged cubicles are there to assist the ambulant disabled, people with babies or small children and/or people with bags.

Standard

A standard WC compartment must have a minimum 450mm diameter manoeuvring space within the cubicle. This is to be maintained between the swing of the door, the WC pan and the side wall of the compartment.

Ambulant Disabled

Every same-sex washroom must have at least one WC compartment (cubicle) that is suitable for the ambulant disabled. If there is only one cubicle in the washroom then this must be suitable for an ambulant disabled person.

In addition the ambulant cubicle must provide the correct grab rails and inner pull handles – for more information see our accessories range (page 86).

Light Reflectance Values

Consideration should also be given to colour contrast to aid partially sighted people. To help you when choosing your colour scheme our colours are graded with an LRV value.

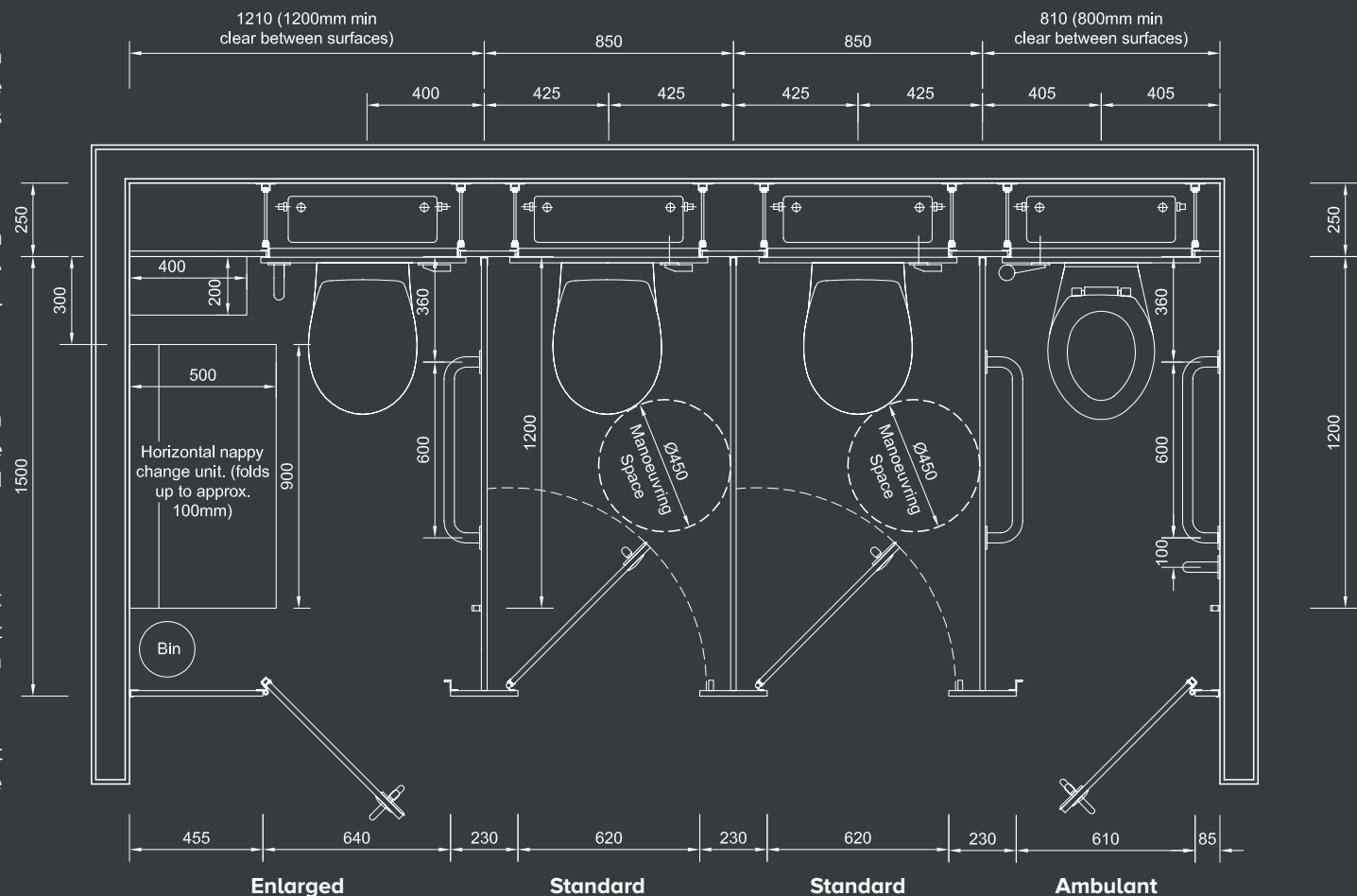

Typical layout requirements for new buildings to meet Building Regulations Part M.

* It is the responsibility of the customer to work towards your obligation to the Equality Act 2010 and to comply with the latest Building Regulations Part M. We recommend you contact your Local Authority Access Control Officer.

CHOOSE YOUR DUCTING SYSTEM

Our ducting and access panel systems can be delivered in three ways.

Whether you choose our Ready Plumbed Modules, Ezeeduct, or Panel Only, we can deliver a flexible, cost-effective solution to suit your needs.

Bushboard Ready Plumbed Modules

First designed over 20 years ago we wanted our RPM system to be the best pre-plumbed system on the market and today over 100,000 units are in use across the UK.

Changing the way washrooms are installed, pre-plumbed systems make duct fitting faster and easier. Delivered ready to install, each module combines a carefully selected range of sanitaryware and brassware fitted to panels and pre-assembled onto a rigid steel frame so on-site labour is kept to a minimum and the finished look is always first class.

Our RPM systems change the way washrooms are installed

The benefits of choosing Bushboard Ready Plumbed Modules



Guaranteed quality: a factory engineered solution that uses standardised processes and the latest manufacturing technology to deliver an exceptionally high quality, durable finished product.

Improved cost control: one product delivered from one source ensuring greater predictability of cost and programming.

Utilisation of off-site skills: removes the interface between joinery and plumbing trades reducing reliance on skilled labour on-site.

Improved sustainability: reduces the impact of construction activities on-site including noise, vehicle movements and waste reduction.

Reduced accidents: transferring work off-site into our controlled production environment reduces site health and safety issues.

Reduced costs: our independent research proves RPM is up to 20% cheaper than traditional timber frame and panelling*.

Time savings on-site: delivered ready to fit,

RPM is proven to be up to 75% faster to install than traditional timber frame and panelling*.

Testing off-site: units are pressure tested prior to delivery to ensure they are ready to install.

Delivery and distribution: units are delivered palletised for ease of handling and distribution on-site.

Optional hinged and lockable access panels

The RPM galvanised steel frame has been specifically designed to incorporate optional hinged panels to meet the increasing demand for quick and easy access to essential services for routine maintenance.

In addition, hinges make for easier manual handling and because panels are not completely removed to access pipework, any risk of damage or water ingress from potentially wet floors is eliminated.

Anti-tamper locks are ideal for areas where security is paramount.



Hinged access panel



Panel stay



Linear-bearing hinge



Anti-tamper lock

* Research carried out by QMP, an independent partnership of surveyors, architects and designers.

Please note: Hinged panels available at a minimum height of 400mm and a maximum width of 850mm. Panels above 1500mm high must have two locks.

READY PLUMBED MODULES

These pre-plumbed units come complete with panels, sanitaryware, brassware and plumbing all assembled onto a rigid aluminium frame ready to install.

01	Framing	Factory assembled rigid galvanised steel frame. Integral rail for wall hung WCs
02	Flashgaps	Supplied oversize for on-site adjustment
03	Panels	Factory fitted access panels
04	Panel docking system	Panels complete with docking system for improved panel alignment
05	Plumbing	Pre-plumbed and pressure tested where appropriate
06	Fittings	Push fit, lift off or hinged panel fittings
07	Tiebacks	Threaded rods lock frame to the building structure
08	Sanitaryware	A dedicated range of sanitaryware specifically chosen and tested for Bushboard RPM units
09	Skirting	Aluminium skirting, pre-finished in Silver or Charcoal Grey Powder Coat. Also available with flashgap skirting option.

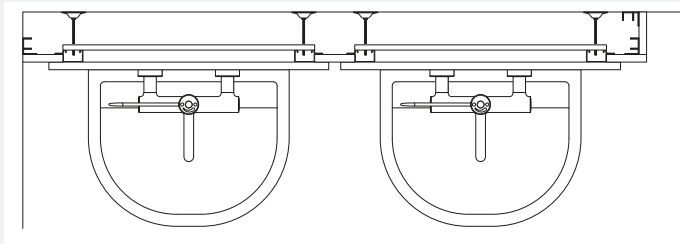

Plan of RPM wall system

View our RPM ducting and vanity videos on our website www.bushboard-washrooms.co.uk

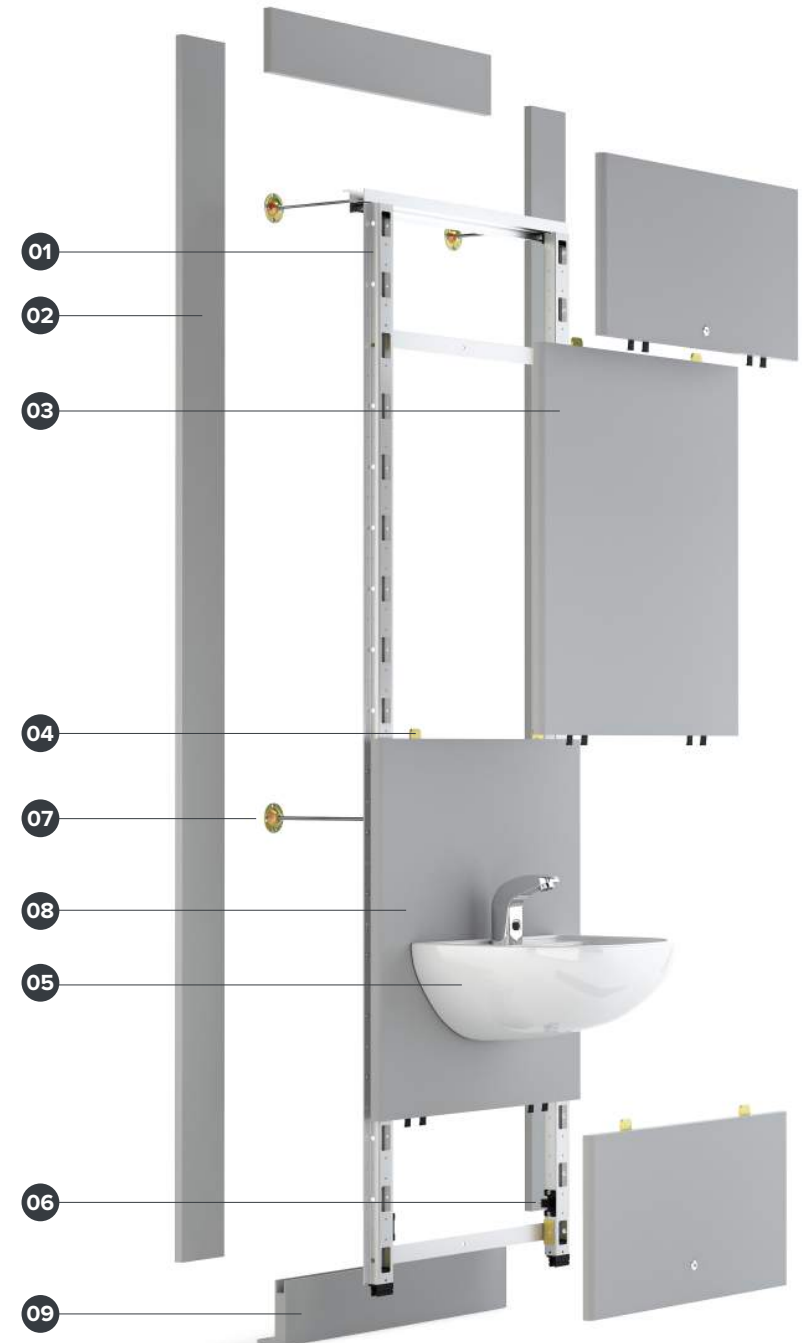

Step 1:



Preparation 15 mins



- Set out position of skirting, tie brackets and wall channel
- Fix skirting to floor
- Fix brackets to wall

Skirting can be provided at an earlier stage to enable installation of floor finishes.

Step 2:



Fixing the RPM units 30 mins



- Cut and fit first flashgap
- Locate the RPM units onto skirting
- Lock tie bars onto wall mounted brackets

Step 3:



Finishing 15 mins



- Cut and fit horizontal and vertical flashgap panels
- Connect services
- Refit access panels

Save time, save money, guarantee quality with Bushboard's Ready Plumbed Modules

HEALTHCARE

Bushboard Washrooms specialise in HBN 00-10 Part C compliant healthcare units, sanitaryware and brassware for clinical environments. Hundreds of hospitals and doctor's surgeries across the country trust Bushboard with their healthcare sanitary assemblies which are constructed with hygiene and durability at the forefront of the design.

Expertise in the industry

Bushboard Washrooms has developed a leading reputation as a supplier of pre-plumbed healthcare units. Drawing on years of expertise, each project is given the attention it deserves.

Leaders in infection control

Bushboard Washrooms put infection control and durability first. Bushboard's healthcare units, sanitaryware and brassware are precision manufactured and factory assembled, conforming to stringent healthcare standards.

Bushboard healthcare sanitary assemblies are:

- HBN 00-10 Part C compliant
- Available as traditional boxed out units, postformed boxed out units, aperture and duct wall systems
- Units arrive on site factory pressure tested and ready to install
- Available with a wide selection of HBN-compliant, WRAS approved, TMV3-approved and Doc M approved sanitaryware and brassware
- Available with sanitaryware and brassware specifically designed for mental healthcare applications



Scrub Up Trough

Traditional Boxed Out Unit with SanCeram Clinical Wash Hand Basin



SCBW122 SanCeram Clinical Healthcare Lever Tap with Removable Spout

For more information on Bushboard's dedicated healthcare products visit our website www.bushboard-washrooms.co.uk





Our post formed boxed out unit is available pre-plumbed with a wide range of HBN-compliant sanitaryware and brassware.

SANITARYWARE AND BRASSWARE

No matter the industry or application, no washroom is complete without the right sanitaryware and brassware to match. With an unrivalled selection of basins, taps, urinals and WCs, Bushboard Washrooms can deliver a leading, cost-effective pre-plumbed solution.

SanCeram

Working in partnership with SanCeram and a number of leading brands, we have carefully selected our sanitaryware and brassware range with quality, durability and cost in mind.

For a more sustainable washroom, we can also help advise you on best fit products to achieve BREEAM certification. Please contact us for further details.

Back to Wall WCs	48
Wall Hung WCs	49
Urinals	50
Flushes	51
Counter Top Basins	52
Semi-Recessed Basins	53
Wall Hung Basins	54
Vessel Basins	55
Monobloc Mixer Taps	56
Tall Taps	57
Pillar Taps	58
Self Closing Taps	58
Sensor Taps	59
Showers	61
Doc M	62





Our Solid Surface Cantilever Vanity with Vessel Basins adds a touch of luxury to any washroom, see page 71 for more information.

BACK TO WALL WC

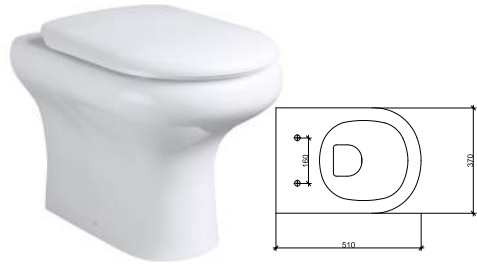

Chartham WC

CHWC102	Pan
CHWC109	Seat and cover
CHWC110	Soft close seat and cover (white)
FEATURES	Standard projection, Box rim flushing



Chartham Rimless 450 Height WC

CHWC103	Pan
CHWC111	Soft close seat and cover (white)
CHWC112	Seat only (white)
CHWC113	Seat only (blue)
CHWC114	Seat only (dark grey)
FEATURES	Standard projection, Rimless flushing



Chartham Rimless 480 Raised Height WC

CHWC104	Pan
CHWC111	Soft close seat and cover (white)
CHWC112	Seat only (white)
CHWC113	Seat only (blue)
CHWC114	Seat only (dark grey)
FEATURES	Raised height for ambulant users, Rimless flushing



Chartham Beyond Rimless WC

CHWC121	Pan
CHWC124	Slim soft close seat and cover
FEATURES	Ultra-sleek easy clean design



Chartham Rimless Projection Healthcare 700 WC

CHWC105	Pan
CHWC111	Soft close seat and cover (white)
CHWC112	Seat only (white)
CHWC113	Seat only (blue)
CHWC114	Seat only (dark grey)
FEATURES	Raised height with extended 700mm projection, Rimless flushing



Chartham Rimless 750 Projection WC

CHWC106	Pan
CHWC111	Soft close seat and cover (white)
CHWC112	Seat only (white)
CHWC113	Seat only (blue)
CHWC114	Seat only (dark grey)
FEATURES	Raised height with extended 750mm projection, Rimless flushing

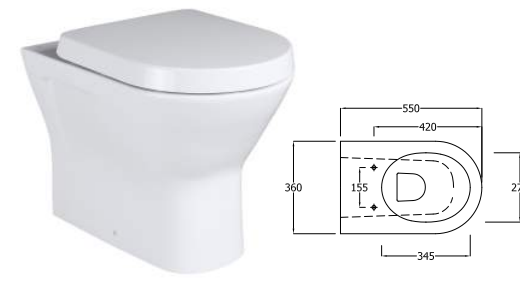

Langley WC

LLWC102	Pan
LLWC105	Soft close seat and cover (white)
LLWC107	Slim soft close seat and cover (white)
FEATURES	Standard projection, Rimless flushing



Langley Curve WC

LLWC122	Pan
CHWC124	Slim soft close seat and cover
FEATURES	Standard projection, Rimless flushing

BACK TO WALL WC

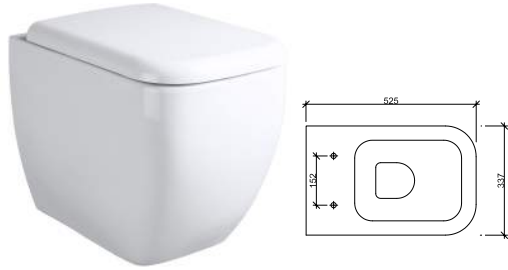

Marden WC

MDWC102 Pan
MDWC104 Soft close seat and cover (white)

FEATURES Standard projection, Box rim flushing



Chartham Beyond Rimless WC

CHWC122 Pan
CHWC124 Slim Soft close seat and cover

FEATURES Standard projection, Rimless flushing

WALL HUNG WC



Langly Curve WC

LLWC121 Pan
LLWC124 Slim soft close seat and cover

FEATURES Standard projection, Box rim flushing

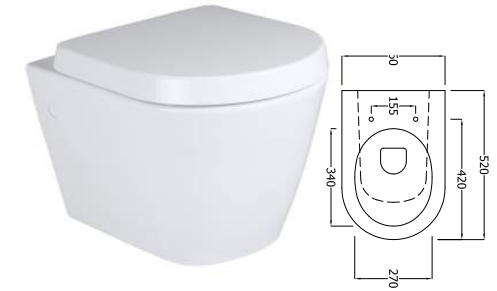

Langley WC

LLWC101 Pan
LLWC105 Soft close seat and cover (white)
LLWC107 Slim soft close seat and cover (white)

FEATURES Standard projection, Rimless flushing

WALL HUNG WC

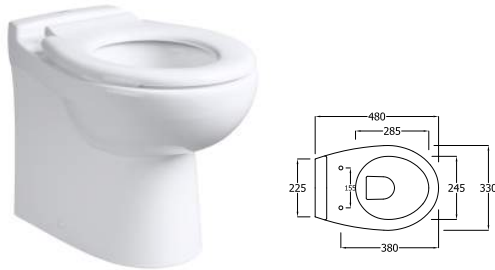

Shenley School 350 Lower Height WC

SHWC101 Pan
SHWC102 Seat only (White)

FEATURES Easy clean 480mm projection, Box rim flushing



Chartham WC

CHWC101 Pan
CHWC109 Seat and cover
CHWC110 Soft close seat and cover (white)

FEATURES Standard projection, Box rim flushing



Marden WC

MDWC101 Pan
MDWC104 Soft close seat and cover (white)

FEATURES Standard projection, Box rim flushing



Chartham Rimless 700 Projection Healthcare WC

CHWC117 Pan
CHWC111 Soft close seat and cover (white)
CHWC112 Seat only (white)
CHWC113 Seat only (blue)
CHWC114 Seat only (dark grey)

FEATURES Extended 700mm projection, Rimless flushing

URINALS



Chartham Exposed Trap Urinal

CHUR104	Urinal
URIN104	Auto Cistern
URIN108	Sensor flush (battery powered)
URIN109	Sensor flush (mains powered)

Features Complete clean bowl design
Exposed bottle trap



Marden Concealed Trap Urinal

MDUR101	Urinal
URIN104	Auto Cistern
URIN108	Sensor Flush (battery powered)
URIN109	Sensor Flush (mains powered)

Features Suitable for all sectors
Concealed bottle trap



Langley Concealed Trap Urinal

LLUR101	Urinal
URIN104	Auto Cistern
URIN108	Sensor flush (battery powered)
URIN109	Sensor flush (mains powered)

Features Suitable for all sectors
Concealed bottle trap



Marden Waterless Urinal

MDUR103	Urinal
----------------	--------

Features Water saving
Easy to clean
Concealed bottle trap



Langley Waterless Urinal

LLUR104	Urinal
----------------	--------

Features Water saving
Easy to clean
Concealed bottle trap

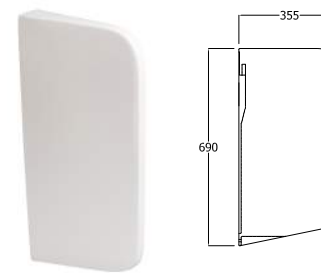

Urinal Separator

CHUR107	Urinal Separator
----------------	------------------

Features Unbranded ceramic urinal separator
Complete with fixings

FLUSHES



Standard Lever Dual Flush

Dimple Lever Dual Flush

Palm Push Flush

Metal Vandal Resistant Flush

Single Flush Sensor Flush

CIST101 Lever Flush

CIST102 Lever Flush

CIST105 Push Button Flush

CIST106 Push Button Flush

CIST108 Sensor Flush

FEATURES Dual flush 6/3 litres
Standard style lever with
vandal-resistant stop

FEATURES Dual flush 6/3 litres
Extended dimple lever,
ideal for less able users
and Doc M areas

FEATURES Single flush 6, 5 or 3 litres
Easy-operation palm push
design

FEATURES Single flush 6, 5 or 3 litres
Stainless Steel flat metal
vandal-resistant push flush

FEATURES Single flush 6, 5 or 3 litres
Hygienic no-touch sensor
Battery or mains powered



Dual Flush Sensor Flush

Palm Push Flush

Oyster Dual Push Plate Flush

Dual Push Plate Flush

Single Flush Sensor Flush

CIST109 Sensor Flush

S4513MY Push Button Flush

CIST107 Dual Flush

S4399AA Dual Flush

S358967 Sensor Flush

FEATURES Dual flush 6/4 litres,
5/3litres or 4/2.6litres
Hygienic no-touch sensor
Battery or mains powered

FEATURES Single flush 6 litres
Easy-operation palm push
design

FEATURES Dual flush 6/4 litres,
5/3 litres or 4/2.6 litres
Oyster shaped intuitive dual
push plate

FEATURES Dual flush 6/4 litres
Intuitive dual push plate with
large and small buttons

FEATURES Single flush 6 litres
Hygienic no-touch sensor
Mains powered

COUNTER TOP BASINS

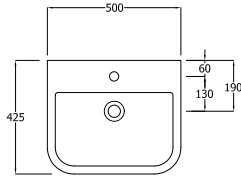

Shenley 500 Counter Top Basin

- SHWB103** Central taphole with overflow
- SHWB104** Two tapholes with overflow and chainstay

FEATURES A space saving basin, great for education environments
Suitable for all sectors excluding healthcare
Bottom outlet for ease of maintenance

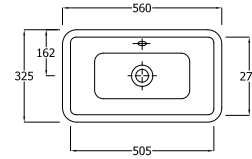

Marden 560 Counter Top Basin

- MDWB107** No taphole with overflow

FEATURES Large modern design suitable for use as an inset or undermounted basin
Suitable for all sectors excluding healthcare
Bottom outlet for ease of maintenance

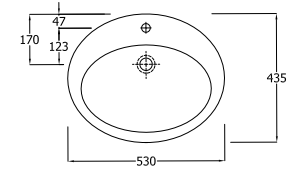

Chartham 530 Counter Top Basin

- CHWB112** Central taphole with overflow

FEATURES A traditional oval shaped inset basin
Suitable for all sectors excluding healthcare
Bottom outlet for ease of maintenance

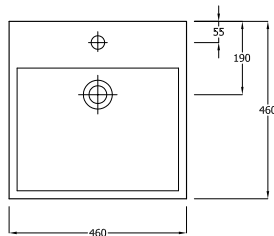

Marden 460 Square Sit On Basin

- MDWB111** Central taphole with overflow
- MDWB112** No taphole with overflow

FEATURES Suitable for use as a wall hung basin
Suitable for all sectors excluding healthcare
Bottom outlet for ease of maintenance

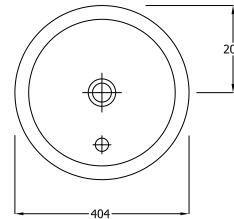

Langley 400 Under Counter Basin

- LLWB107** No taphole with overflow

FEATURES A small minimalist basin for use with vanity or wall mounted tops
Suitable for all sectors excluding healthcare
Bottom outlet for ease of maintenance

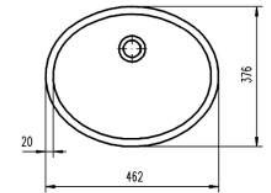

Integral Solid Surface Basin

- SOV10000** Pre-plumbed with overflow

FEATURES Integral Solid Surface basin creating a seamless vanity top
Suitable for all sectors excluding healthcare
Bottom outlet for ease of maintenance

SEMI-RECESSED BASINS

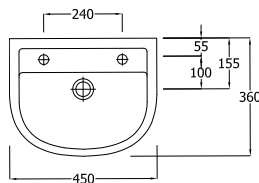

Chartham 450 Semi-Recessed Basin

- CHWB108** Two tapholes with overflow and chainstay
- CHWB109** Right hand taphole with overflow

FEATURES A small basin, perfect for space saving
Suitable for all sectors excluding healthcare
Bottom outlet for ease of maintenance

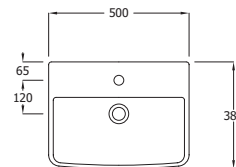

Langley 500 Semi-Recessed Basin

- LLWB104** Central taphole with overflow

FEATURES A contemporary rectangular basin with a sleek, sloping base
Suitable for all sectors excluding healthcare
Bottom outlet for ease of maintenance

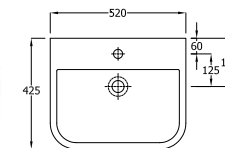

Marden 520 Semi-Recessed Basin

- MDWB105** Central taphole with overflow
- MDWB106** Two tapholes with overflow and chainstay

FEATURES A large, deep basin with a modern square design
Suitable for all sectors excluding healthcare
Bottom outlet for ease of maintenance

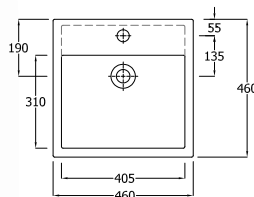

Marden 460 Square Semi-Recessed Basin

- MDWB113** Central taphole with overflow

FEATURES The iconic Marden Square angular basin
Suitable for all sectors excluding healthcare
Bottom outlet for ease of maintenance

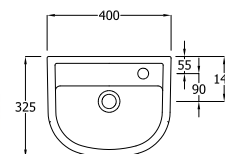

Shenley 400 Slim Semi-Recessed Basin

- SHWB105** Right hand taphole with overflow

FEATURES Small design suitable for restricted space
Suitable for all sectors excluding healthcare
Bottom outlet for ease of maintenance

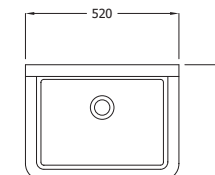

Chartham Cleaners Sink

- CHSK101** 520mm with 250mm back

Features All sectors excluding healthcare
Heavy duty with hard-wearing glaze
Fireclay

WALL HUNG BASINS

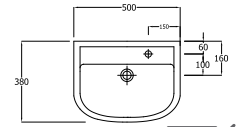
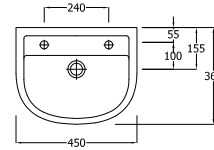
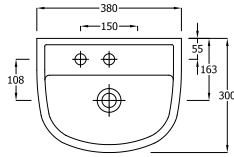

Chartham 380 Wall Hung Basin

- CHWB101** Left hand taphole no overflow
- CHWB102** Right hand taphole no overflow

FEATURES HBN and Doc M compliant
Suitable for all sectors
Bottom outlet for ease of maintenance

Chartham Wall Hung Basin 450

- CHWB103** Two tapholes with overflow and chainstay
- CHWB104** Centre taphole with overflow

FEATURES A classic shaped basin in two designs
Suitable for all sectors excluding healthcare
Bottom outlet for ease of maintenance

Chartham Wall Hung Basin 500

- CHWB105** Right hand taphole no overflow

FEATURES HBN compliant
Suitable for all sectors excluding healthcare
Bottom outlet for ease of maintenance

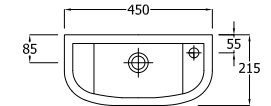
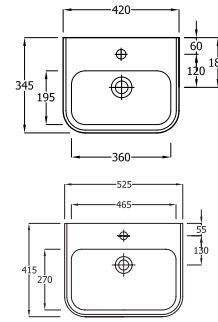
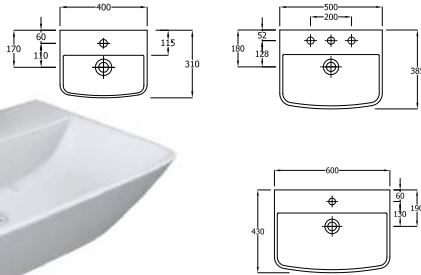

Langley Wall Hung Basin 400/500/600

- LLWB101** 400mm, Central taphole with overflow
- LLWB109** 500mm, Central taphole with overflow
- LLWB110** 600mm, Central taphole with overflow

FEATURES A modern, rectangular basin with a sleek sloping base
Suitable for all sectors excluding healthcare
Bottom outlet for ease of maintenance

Marden 420/525 Wall Hung Basin

- MDWB101** Central taphole with overflow
- MDWB103** Central taphole with overflow

FEATURES A deep basin with a modern square design
Suitable for all sectors excluding healthcare
Bottom outlet for ease of maintenance

Shenley 450 Slim Wall Hung Basin

- SHWB101** Right hand taphole with overflow

FEATURES For washrooms where space is tight
Suitable for all sectors excluding healthcare
Bottom outlet for ease of maintenance

VESSEL BASINS



Langley Vessel Basin

LLWB108 No taphole or overflow

FEATURES Modern oval vessel for use with tall taps
Suitable for all sectors excluding healthcare
Bottom outlet for ease of maintenance



Langley Rectangular Vessel Basin

LLWB121 No taphole or overflow

FEATURES A contemporary rectangular basin
Suitable for all sectors excluding healthcare
Bottom outlet for ease of maintenance



Langley Circular Vessel Basin

LLWB122 No taphole or overflow

FEATURES A contemporary circular basin
Suitable for all sectors excluding healthcare
Bottom outlet for ease of maintenance



Langley Oval Vessel Basin

LLWB123 No taphole or overflow

FEATURES A contemporary oval basin
Suitable for all sectors excluding healthcare
Bottom outlet for ease of maintenance



Chartham Beyond Vessel Basin

CHWB120 No taphole or overflow

FEATURES Modern oval vessel for use with tall taps
Suitable for all sectors excluding healthcare
Bottom outlet for ease of maintenance

MONOBLOC MIXER TAPS



Hartley Mono Basin Mixer Tap

- HABW101** Chrome
- HABW101B** Matt Black
- HABW101N** Brushed Nickel

FEATURES Deck mounted
Directional slim stream aerator
Supplied with flexi-tails



Langley Mono Basin Mixer Tap

- LLBW106** Chrome

FEATURES Deck mounted
Directional slim stream aerator
Supplied with flexi-tails



Adore Mini Basin Mixer Tap

- ADORE113** Chrome

FEATURES Deck mounted
Tilt and turn temperature and flow



Adore Enviro-Klick Mono Basin Mixer Tap

- ADORE113-EK** Chrome

FEATURES Deck mounted
Tilt and turn temperature and flow



SanCeram Sequential Thermostatic Basin Mixer Tap

- SCBW120** Chrome

FEATURES Deck mounted
Lever operated
Safe touch body
Self draining spout



Vision Lever Mixer Tap

- VSN113** Chrome

FEATURES Deck mounted
Lever action



Vision Wall Mounted Basin Mixer Tap

- VSN122** Chrome

FEATURES Lever operation
Tilt and turn temperature and flow
Separate spout and operating control



Hartley Wall Mounted Mixer Tap

- HAB103** Chrome
- HAB103B** Matt Black
- HAB103N** Brushed Nickel

FEATURES Directional slim stream aerator
Tilt and turn temperature and flow

MONOBLOC MIXER TAPS



Insignia Mono Basin Mixer Tap

INS113 Chrome

FEATURES Deck mounted
Lever action

Swoop Deck Mounted Mono Basin Mixer Tap

SWO113 Chrome

FEATURES Deck mounted
Lever action

Marden Mono Basin Mixer Tap

MDBW101 Chrome

FEATURES Deck mounted
Slim stream aerator

Chartham Mono Basin Mixer Tap

SCBW101 Chrome

FEATURES Deck mounted
Directional aerator

TALL TAPS Suitable for use with vessel basins



Hartley Tall Mono Basin Mixer Tap

HABW102 Chrome
HABW102B Matt Black
HABW102N Brushed Nickel

FEATURES Deck mounted
Directional slim stream aerator
Supplied with flexi-tails

Langley Tall Mono Basin Mixer Tap

LLBW105 Chrome

FEATURES Deck mounted
Directional slim stream aerator
Supplied with flexi-tails

Marden Tall Mono Basin Mixer Tap

MDBW102 Chrome

FEATURES Deck mounted
Slim stream aerator

Swoop Tall Deck Mounted Mono Basin Mixer Tap

SWO113/EX Chrome

FEATURES Deck mounted
Lever action

Deva Tall Deck Mounted Sensor Tap

SENSOR3D Chrome

FEATURES Sensor operation

PILLAR TAPS



Deva Lever Action Basin Taps

DLT101 Chrome

FEATURES Deck mounted
Lever action
1/4 turn flow control levers



Insignia Lever Action Taps

INS101 Chrome

FEATURES Tilt and turn
Lever action
Temperature and flow control lever



SanCeram Contemporary Press Action Taps

SCBW124 Chrome

FEATURES Easy press
Timed flow with auto close
Anti block function



Deva Press Action Taps

NCT001 Chrome

FEATURES Deck mounted
Self closing
Pre-set automatic shut off after 8 secs

SELF CLOSING TAPS



Deva Wall Mounted Lever Bib Taps

DLT095 Chrome

FEATURES Lever operation
1/4 turn flow control levers



SanCeram Self Closing Toggle Tap

SCBW107 Chrome

FEATURES Pre-set automatic shut off after 15 secs
Recommended for nursery and Primary Schools



SanCeram Self Closing Mixer Tap

SCBW106 Chrome

FEATURES Basin mounted
Self closing
Non concussive



Vision Self Closing Mixer Tap

VSN123 Chrome

FEATURES Press action
Tamper proof

SENSOR TAPS



SanCeram Deck Mounted Sensor Tap

SCBW119 Chrome

Features Sensor operation
Battery powered
24 hour hygiene flush



Aquarius A45 Sensor Tap

ATO3011 Chrome

Features Sensor operation
Mains or battery powered



Deva Mono Basin Sensor Tap

SENSOR1D Chrome

Features Sensor operation
Mains or battery powered



Deva Deck Mounted Temperature Adjustable Sensor Tap

SENSOR6BT Chrome

FEATURES Sensor operation
Temperature adjustment lever
Mains or battery powered



Deva Wall Mounted Sensor Tap

SENSOR9W Chrome

FEATURES Sensor operation
Tamper proof
Max temperature 45 degrees
Mains powered with battery backup



Aquarius Wall Mounted Sensor Tap

ATO2001 Chrome

FEATURES Sensor operation
Stainless steel construction
Mains or battery powered



SHOWERS



Thermostatic Bar Shower and Slider Rail

SHWR111 Shower Pack

FEATURES Safe cool to touch body
Satinjet handset
1.5m easy clean hose
9ltr/min flow regulator

Sequential Lever Operated Concealed Shower Valve

SHWR112 Concealed Mixer Valve

SHWR113 Exposed Mixer Valve

FEATURES Failsafe hot and cold supplies
6ltr/min flow regulator

Self Closing Shower Valve

SHWR122 Concealed Self Closing Valve

SHWR123 Exposed Self Closing Valve

FEATURES Water saving
15 second flow time at 1 bar pressure
6ltr/min flow regulator

Grab rail based shower kit

SHWR115 Shower Kit

FEATURES 900mm grab rail
6ltr/min flow regulator
2m shower hose



Anti-Ligature Fixed Shower Head

SHWR118 Chrome

FEATURES Anti-ligature design
Brass body
Hidden wall fixing for security

Vandal Resistant Shower Head

SHWR124 Chrome

FEATURES Brass body
Hidden wall fixing for security
Concealed or exposed fixing connection
Adjustable spray pattern

DOC M

Complete Doc M and shower packs, grab rails, support rails and backrests.

SanCeram Closed Coupled Doc M Pack

SCDMCCLW	White Left Hand
SCDMCCRW	White Right Hand
SCDMCCLB	Blue Left Hand
SCDMCCRB	Blue Right Hand
SCDMCCLG	Grey Left Hand
SCDMCCLB	Grey Right Hand
SCDMCCSS	Stainless Steel Left Hand
SCDMCCRSS	Stainless Steel Right Hand

Features: Close coupled rimless WC pan with dual flush lever operated cistern, left or right handed basin with sequential TMV3 mixer tap, waste and trap, all required grab rails and support arms.

SanCeram Back to Wall Doc M Pack

SCDMBTWLW	White Left Hand
SCDMBTWLB	White Right Hand
SCDMBTWRB	Blue Left Hand
SCDMBTWLG	Blue Right Hand
SCDMBTWRG	Grey Left Hand
SCDMBTWRG	Grey Right Hand
SCDMBTWLSS	Stainless Steel Left Hand
SCDMBTWRSS	Stainless Steel Right Hand

Features: Back to wall rimless WC pan with dual flush lever operated cistern, left or right handed basin with sequential TMV3 mixer tap, waste and trap, all required grab rails and support arms.

SanCeram Doc M Shower Pack

SCDMSHCWH	Concealed with white rails
SCDMSHEWH	Exposed with white rails
SCDMSHCBL	Concealed with blue rails
SCDMSHEBL	Exposed with blue rails

Features: Recessed TMV3 sequential shower valve, fixed shower head, handset and hose, diverter valve, grab rails, drop down support arms, shower curtain and rail, seat and robe hook.

SanCeram 600mm Straight Grab Rail

GRAB102	White
GRAB105	Blue
GRAB108	Light Grey
GRAB111	Grey
GRAB114	Stainless Steel

Features: Powder Coated 600mm grab rail.

SanCeram 450mm Straight Grab Rail

GRAB101	White
GRAB104	Blue
GRAB107	Light Grey
GRAB110	Grey
GRAB113	Stainless Steel

Features: Powder Coated 450mm grab rail.

SanCeram 800mm Hinged Grab Rail

GRAB103	White
GRAB106	Blue
GRAB109	Light Grey
GRAB112	Grey
GRAB115	Stainless Steel

Features: Powder Coated 800mm hinged grab rail with toilet roll holder.

SanCeram Backrest

GRBR101	White
GRBR102	Blue
GRBR103	Light Grey

Features: Powder Coated backrest rail.

SanCeram Grab Rail Kit

GRAB116	White
GRAB117	Blue
GRAB118	Grey

Features: 5 x 600mm grab rails and 1 x 800mm hinged grab rail with toilet roll holder.



EZEEDUCT

Choose Ezeeduct and you gain many of the features and benefits of RPM combined with your own sanitaryware and brassware choice. For cost effectiveness you can even reuse existing sanitaryware with Ezeeduct.

01	Framing	Factory assembled rigid galvanised steel frame
02	Flashgaps	Supplied oversize for on-site adjustment
03	Panels	Factory fitted access panels suitable for use with your own sanitaryware and brassware
04	Fittings	Push fit, lift off or hinged panel fittings
05	Tiebacks	Threaded rods, lock frame to the building structure
06	Skirting	Aluminium skirting, pre-finished in Silver or Charcoal Grey Powder Coat. Also available with flashgap skirting option

Specification Options

Performance

MFC
HPL
SGL
Real Wood Veneer
ColourCoat™

We supply

Rigid steel frame
Access panels
Flashgap panels
Powder Coated skirting
Panel fittings

Colours

Full colour range

You supply

Sanitaryware
Brassware

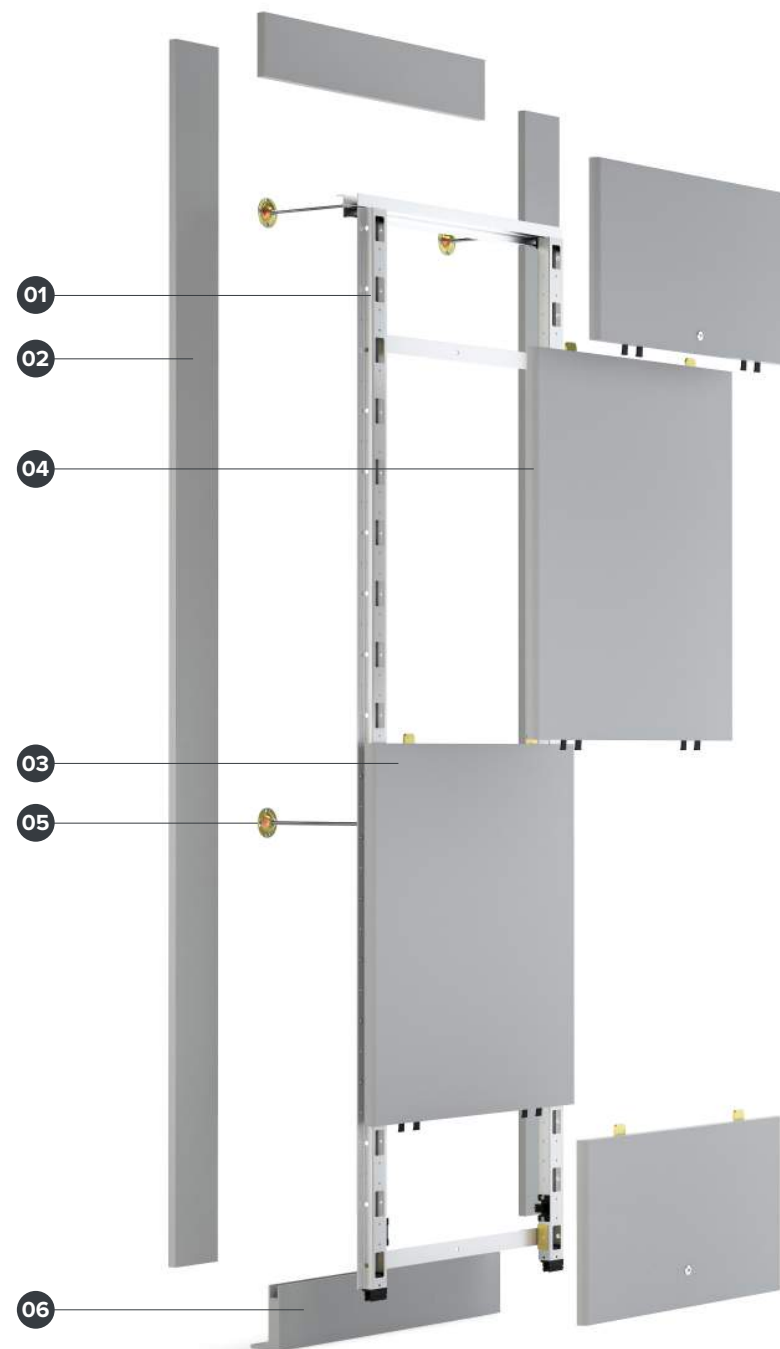

PANEL ONLY

Our Panel Only option allows you to use our ducting and access panels with your own on-site timber framing, sanitaryware and brassware.

Our panels are available with either lift off or push fit clips determined by panel position. For added security and easy access choose hinged lockable access panels.

01	Flashgaps	Supplied oversize for on-site adjustment
02	Panels	Suitable for use with your chosen sanitaryware and brassware
03	Fittings	Push fit, lift off or hinged panel fittings
04	Frame	Supplied by others

Specification Options

Performance

MFC
HPL
SGL
Real Wood Veneer
ColourCoat™

Colours

Full colour range

We supply

Access panels
Flashgap panels
Panel fittings

You supply

On-site framing
Sanitaryware
Brassware
Skirting

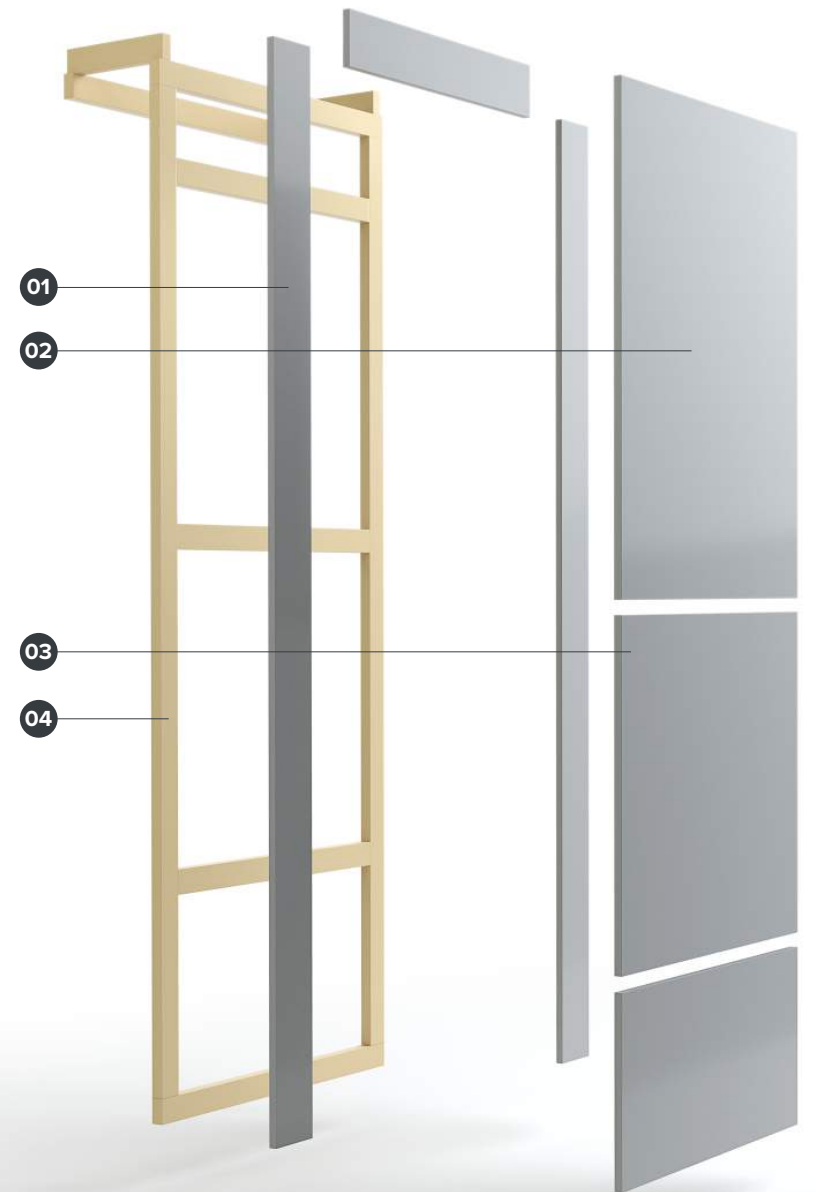

VANITY SYSTEMS

Whether you are designing a highly luxurious washroom or are looking for understated simplicity, our range of vanity units are smart, clean and practical.

Choose Counter Top, Semi-Recessed, Cantilever or our luxurious Solid Surface Washtrough.

Design your perfect vanity unit online using our Design Tool. Save, print and share your designs at www.bushboard-washrooms.co.uk

COUNTER TOP

Smart and hardwearing, our Counter Top vanity units create depth and deliver additional space.

Available with a Solid Surface top and integral basin for the sleekest of finishes.

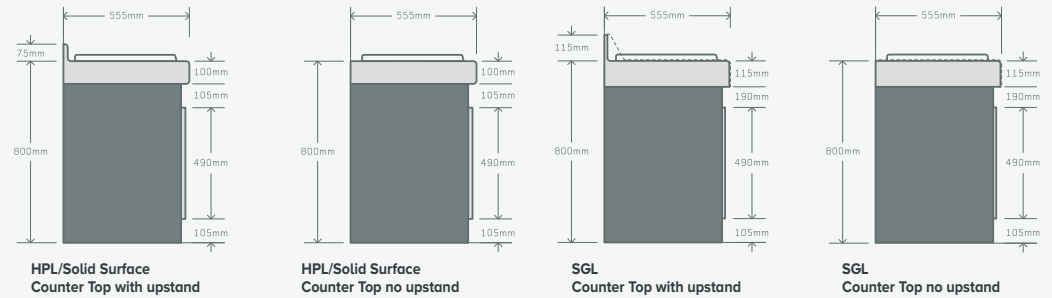

Performance	Vanity Top: HPL, SGL or Solid Surface Vanity Underpanel: MFC, HPL or SGL, Real Wood Veneer or ColourCoat™
Upstand	Optional
Vanity Ends	With or without finished ends
Colours	Top: 34 laminate colours 12 Solid Surface Options Underpanels: 34 laminate colours 11 Real Wood Veneer 10 ColourCoat™ options
Dimensions	Bed Depth: 555mm Downstand: HPL: 100mm SGL: 115mm Solid Surface: 100mm Optional Upstand: HPL: 75mm SGL: 115mm Solid Surface: 75mm Bed Heights: Adult: 800mm Junior: 750mm Infant: 675mm Nursery: 600mm Max. Lengths: HPL: 2770mm SGL: 2750mm SS: 3000mm



SEMI-RECESSED

Slim and stylish, our Semi-Recessed vanity units are ideal for areas where space is tight.

The universal style makes these simple yet functional units perfect for any washroom environment.

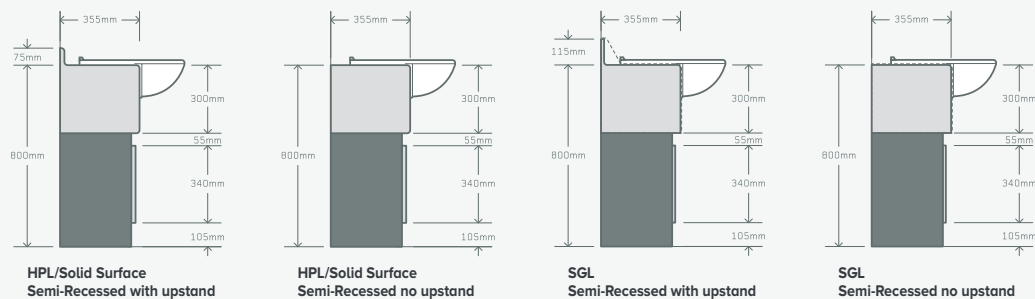

Performance	Vanity Top: HPL, SGL or Solid Surface	
	Vanity Underpanel: MFC, HPL or SGL, Real Wood Veneer or ColourCoat™	
Upstand	Optional	
Vanity Ends	With or without finished ends	
Colours	Top:	34 laminate colours
		12 Solid Surface Options
	Underpanels:	34 laminate colours
		11 Real Wood Veneers
		10 ColourCoat™ options
Dimensions	Bed Depth:	355mm
	Downstand:	300mm
	Optional Upstand:	
	HPL:	75mm
	SGL:	115mm
	Solid Surface:	75mm
	Bed Heights:	
	Adult:	800mm
	Junior:	750mm
	Infant:	675mm
	Nursery:	600mm
	Max. Lengths in one section:	
	HPL:	2770mm
SGL:	2750mm	
SS:	3000mm	



WASHTROUGHS

Our luxurious washtrough is available in 2 designs; Hydra with its sleek sloping base and Centurus with its contemporary flat bed.

Superbly crafted from our flawless Solid Surface composite, Bushboard's washtroughs deliver a seamless finish that is exceptionally hardwearing. Available with cantilever fittings for the ultimate in minimalist style, or with underframe and panels for a contemporary spin on the traditional washroom environment.

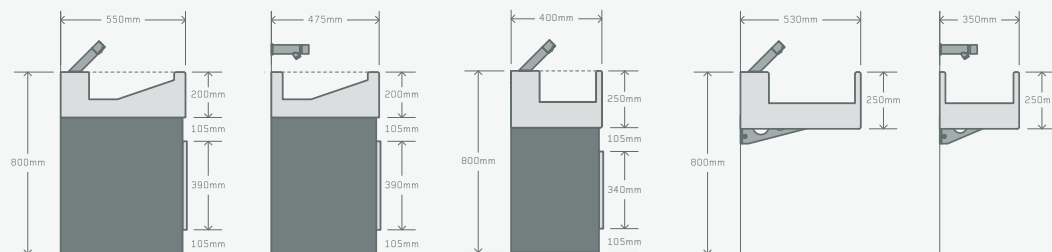

Hydra Solid Surface Washtroughs with deck mounted taps and underframe

Centurus Schools Solid Surface Washtrough with deck mounted taps and underframe

Centurus Solid Surface Washtroughs with wall mounted taps and cantilever brackets

Both washtrough styles are available with an underframe and panels or cantilever.

Performance	Solid Surface
	Underpanels: MFC, HPL or SGL, Real Wood Veneer or ColourCoat™
Vanity Ends	Trough: Finished ends
	Underpanels: With or without finished ends
Colours	Trough: 12 Solid Surface Options
	Underpanels: 34 laminate colours
	11 Real Wood Veneers
	10 ColourCoat™ options
Dimensions	Bed Depth: Hydra: 550mm (with deck mounted taps) or 475mm (with wall mounted taps)
	Centurus: 530mm (with deck mounted taps), 350mm (with wall mounted taps) or 400mm (for schools with deck mounted taps).
	Downstand: Hydra: 200mm
	Centurus: 250mm
	Lip Heights:
	Adult: 800mm
	Junior: 750mm
	Infant: 675mm
	Nursery: 600mm
	Max. Length in one section: 3000mm



SOLID SURFACE

Solid Surface is a contemporary and stylish solution for Counter Top and Semi-Recessed vanity units.

Solid Surface vanities can be specified with all of our semi-recessed and counter top basins. Choose our integral Solid Surface counter top for a seamless, modern finish.

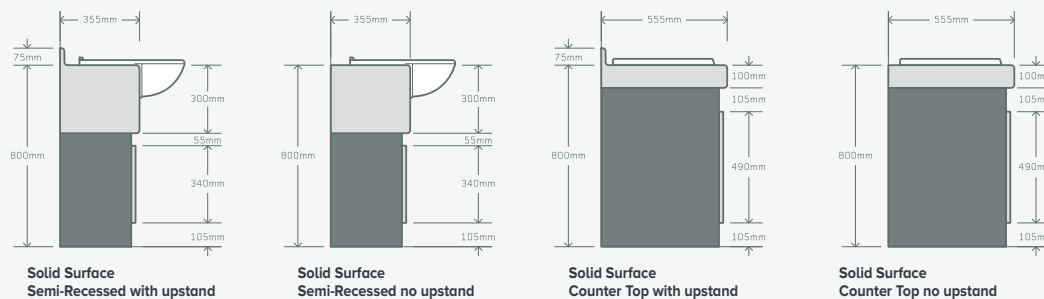

Performance	Solid Surface
Upstand	Optional
Vanity Ends	With or without finished ends
Colours	12 Solid Surface options
Dimensions	<p>Bed Depth:</p> <p>Semi-Recessed: 355mm</p> <p>Counter Top: 555mm</p> <p>Optional Upstand:</p> <p>Counter Top: 75mm</p> <p>Semi-Recessed: 75mm</p> <p>Downstand:</p> <p>Semi-Recessed: 300mm</p> <p>Counter Top: 100mm</p> <p>Bed Heights:</p> <p>Adult: 800mm</p> <p>Junior: 750mm</p> <p>Infant: 675mm</p> <p>Nursery: 600mm</p> <p>Max. Length in one section: 3000mm</p>



CANTILEVER

Elegant and understated, our stunning Cantilever vanities offer the perfect finishing touch to the most prestigious of washrooms.

Available in HPL, SGL and Solid Surface, vanities are fixed with concealed cantilever brackets delivering a finish that is complete simplicity. Available in both Semi-Recessed and Counter Top styles, Cantilever offers a modern alternative to the traditional vanity unit.

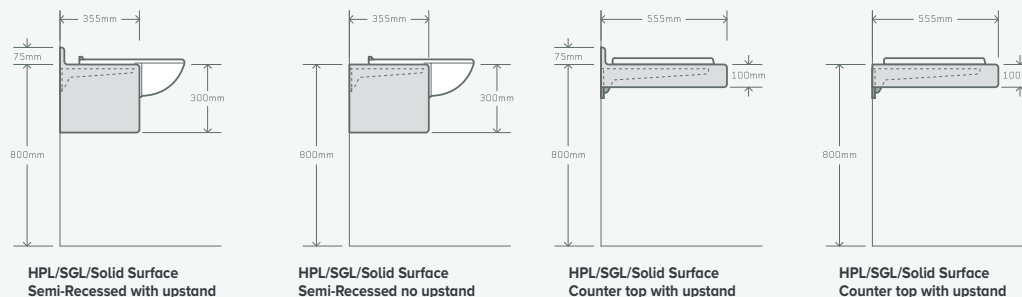

Note: SGL vanities have a 115mm downstand and optional 115mm upstand.

Performance	HPL, SGL, Solid Surface	
Upstand	Optional	
Vanity Ends	With or without finished ends	
Colours	34 laminate colours 12 Solid Surface options	
Dimensions	Bed Depth: Semi-Recessed 355mm Counter Top 555mm Optional Upstand: HPL: 75mm SGL: 115mm Solid Surface: 75mm Downstand: Semi-Recessed 300mm Counter Top HPL: 100mm SGL: 115mm Solid Surface: 100mm Bed Height: 800mm Max. Length in one section: HPL: 2770mm SGL: 2750mm Solid Surface: 3000mm	



VANITY OPTIONS

View our RPM ducting and vanity videos on the website at www.bushboard-washrooms.co.uk

RPM



EZEEVANITY



Ready Plumbed Modules combine a dedicated range of sanitaryware and brassware with the simplicity of our vanity top, underframe and panels.

We supply:

- Vanity Top
- Sanitaryware
- Brassware
- One piece vanity underframe
- Underpanels

Ezeevanity delivers all the benefits of RPM but for use with your own or existing sanitaryware.

We supply:

- Vanity Top
- One piece vanity underframe
- Vanity underpanels

You supply:

- Sanitaryware
- Brassware

PANEL ONLY



Panel Only offers you the flexibility of installing your own timber framework on-site.

We supply:

- _____ Vanity Top
- _____ Flashgaps
- _____ Underpanels

You supply:

- _____ Timber frame construction
- _____ Sanitaryware
- _____ Brassware

BABY CHANGE

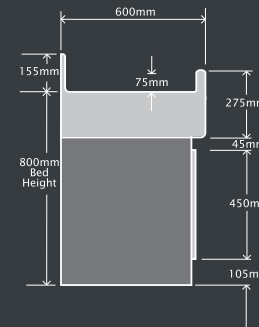

Side elevation baby change

SGL EXTRUSIONS

All SGL vanity unit profiles are linked using aluminium extrusions in Silver or Charcoal Grey Powder Coat.



Rear upstand extrusion



Front downstand extrusion

LIGHT PELMETS

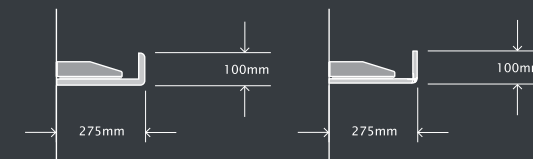

HPL

SGL

FAST TRACK

A complete off-the-shelf washroom in 48 hours

Fast Track is one of the most comprehensive fast-delivery washroom ranges available. Including cubicles, ducting and vanity units, Fast Track is a stylish, durable and economical washroom for dry areas, delivered box packed for easy handling. Panels are cut to size on-site and edges concealed in continuous channels.

A stylish and economical cubicle featuring durable dark grey fixtures and fittings. A choice of square edge or postformed pilasters is available as well as a children's height door and the option of enlarged and ambulant cubicles.

Finish	Laminate
Performance	MFC
Pilasters	Square edge with matching 1mm PVC lipping
Fittings	Dark Grey
Standard Height	1950mm (including floor clearance)
Floor Clearance	100mm
Colours	6 Colour options for all panels

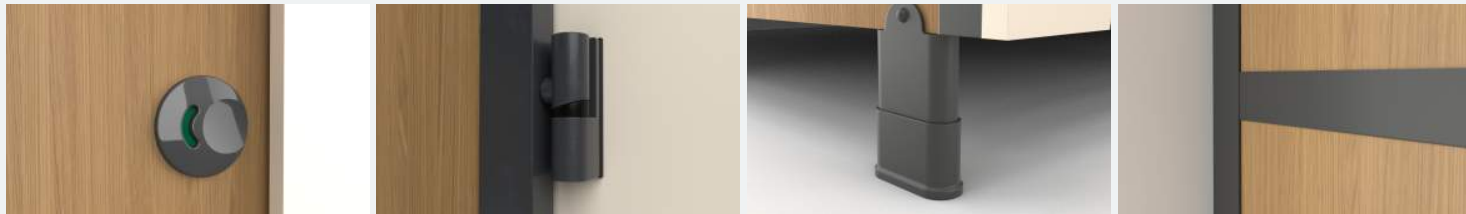

Faceplate

Hinge

Pedestal Foot

Wall Channel and H Section





ABOVE – FAST TRACK CUBICLES

Doors: Oak | **Pilasters:** Sand | **Fittings:** Charcoal | **Vanity:** Counter Top Vanity Unit in Oak with Sand undervanity and Oak panels | **Basin:** Shenley 500 Counter Top Basin | **Tap:** Langley Mono Basin Mixer Tap

FAST TRACK CUBICLES

- All components delivered to standard dimensions, boxed and clearly labelled
- Partitions and doors can be cut to size on site and edges concealed in channels
- Channels accommodate out of line walls
- Packs include detailed installation instructions

C1 Door Pack with Pilasters

Outward opening/inward opening Wheelchair, Ambulant and Enlarged

- 1 door 1850 x 900mm
- 1 pilaster 1850 x 220mm
- 1 pilaster drilled for hinge 1850 x 115mm
- 1 pilaster no hinge 1850 x 115mm
- 1 pilaster for enlarged cubicle drilled for hinge 1850 x 400mm
- 3 UPVC door cap/wall channels 1850mm
- 1 Aluminium headrail – Dark Grey 1800mm

C1C Children's Door Pack with Pilasters

- 1 door 1850 x 900mm
- 1 pilaster 1850 x 220mm
- 1 pilaster drilled for hinge 1850 x 115mm
- 1 pilaster no hinge 1800 x 115mm
- 1 pilaster for enlarged cubicle drilled for hinge 1850 x 400mm
- 3 UPVC door cap/wall channels 1850mm
- 1 aluminium headrail – Dark Grey 1800mm

C2 Partition Pack

- 2 partitions "halves" 925 x 1800mm
- 1 UPVC H section 1750mm
- 1 UPVC door cap/wall channel 1850mm

C3 Inline Pack with Pilasters

- 1 large pilaster 1850mm x 900mm
- 1 pilaster drilled for hinge 1850 x 550mm
- 1 aluminium headrail – Dark Grey 1800mm

C1FB Fittings Pack

- 1 polycarbonate indicator bolt
- 1 outward keep
- 3 hinges Dark Grey
- 1 toilet roll holder
- 1 coat hook
- 1 polycarbonate pedestals
- Screws, plugs and channel through fixings

C4 Floor to Ceiling Post

- Required when ordering free standing cubicles.
- 1 floor to ceiling post 3750mm
 - 2 flanges
 - 1 UPVC door cap/wall channel 1850mm
 - Screws, plugs and channel through bolt fixings

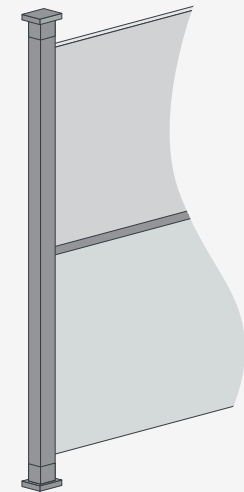

FAST TRACK DUCT PANELS

Fast Track duct panels can incorporate most standard sanitaryware items.

- All components delivered to standard dimensions, boxed and clearly labelled
- Duct widths and heights can be varied by adjusting width of flashgaps
- Installer to provide appropriate timber frame to support duct panels (typically 50mm x 50mm softwood frame)
- Packs include detailed installation instructions

Shelf Height

P4 Plain Panel

- 1 plain panel 2250 x 300mm

Plain Panel/Return End

- 1 plain panel 2250 x 300mm

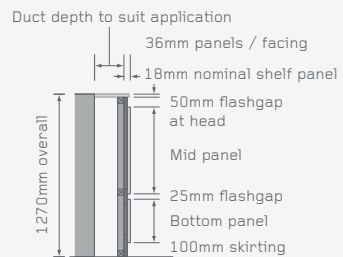

Standard Height

F1 Flashgap Pack

- 2 flashgaps – unedged 2600 x 200mm
- 1 flashgap – edged 2600 x 201mm
- 16 shrinkage plates and screws

P1 Washbasin/WC Panel Pack

- 1 bottom panel 405 x 700mm
- 1 middle panel 670 x 700mm
- 1 top panel 1125 x 700mm
- 1 x 1mm PVC re-edging strip 2500mm
- 16 plastic clips and screws

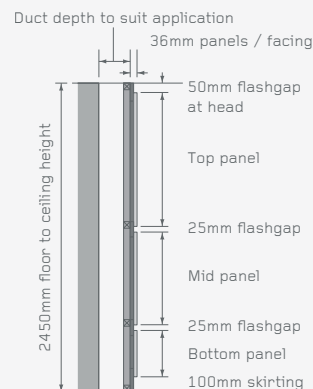

P2 Urinal Panel Pack

- 1 bottom panel 225 x 700mm
- 1 middle panel 850 x 700mm
- 1 top panel 1125 x 700mm
- 1 x 1mm PVC re-edging strip 2500mm
- 16 plastic clips and screws

P3 Plain Panel

- 1 plain panel 2250 x 700mm
- 1 x 1mm PVC re-edging strip 2500mm
- 10 plastic clips and screws

P4 Plain Panel

F1

P2

P1

P4

- 1 plain panel 2250 x 300mm
- 1 x 1mm PVC re-edging strip 2500mm
- 10 plastic clips and screws



FAST TRACK VANITIES

Fast Track vanity units can incorporate most standard sanitaryware items.

- All components delivered to standard dimensions, boxed and clearly labelled
- For longer lengths, units can be butt jointed/cut to length on site
- Packs inclusive of detailed installation instructions

Performance	Vanity top: HPL	
	Vanity underpanel: MFC	
Colours	6 colour options for all panels	
Service	Fast Track	
Upstand	Integral upstand	
Dimensions	Length	1500mm
	Bed Depth	555mm
	Downstand	100mm

V1 Vanity Unit

- 1375 x 555mm top with 75mm postformed upstand and 100mm downstand, returns and support brackets
- 2 loose underframe return ends 750 x 455mm
- 1 under panel 1245 x 645mm
- Clips and screws
- 3 unedged flashgaps 1300 x 200mm
- 1 x 1mm PVC re-edging strip 1000mm
- Fixing brackets and screws

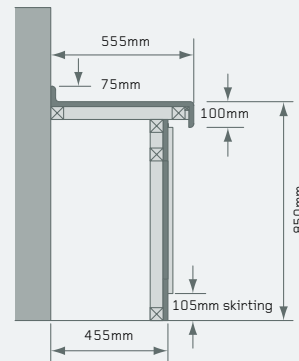
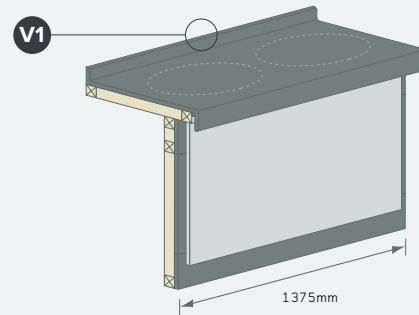

Fast Track Colours

Our colours are graded with a light reflective value (LRV) to help ensure your washroom complies with current legislation*.



Blue
LRV 20



Green
LRV 66

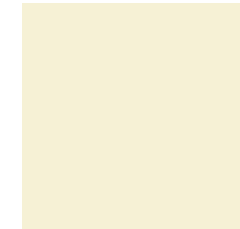

Sand
LRV 66

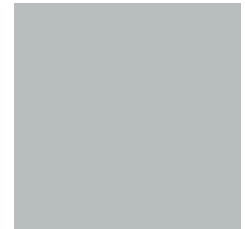

Light Grey
LRV 37



Dark Grey
LRV 10



Oak
LRV 36



Faceplate
Dark Grey

Cubicle Fittings



Nylon Toilet Roll Holder



Nylon Coat Hook



Internal Grab Rail

* Contact your local access control officer.

A step by step guide to selecting your Fast Track washroom packs.

Call our friendly sales team who will help process your order on 01536 533620.

1. Cubicle selection

- Identify the layout of the cubicles you require from these four options and refer to the table next to it
- Identify the number of cubicles you require along the top row of the grid
- Read down the column to determine the pack and quantity you require

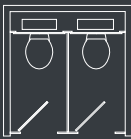

Between walls

No. Cubicles	1	2	3	4	5	6	7	8
Door Pack	1	2	3	4	5	6	7	8
Fittings Pack	1	2	3	4	5	6	7	8
Partition Pack	0	1	2	3	4	5	6	7
Floor/Ceiling post pack	0	0	0	0	0	0	0	0
Max. Width (mm)	1060	2120	3180	4240	5300	6360	7420	8480



Against walls

No. Cubicles	1	2	3	4	5	6	7	8
Door Pack	1	2	3	4	5	6	7	8
Fittings Pack	1	2	3	4	5	6	7	8
Partition Pack	1	2	3	4	5	6	7	8
Floor/Ceiling post pack	0	0	0	0	0	0	0	0
Max. Width (mm)	1060	2120	3180	4240	5300	6360	7420	8480

2. Ducting selection

- For each range of panels determine how many you want of each type
- Check they will fit in the space available

Please note: Always leave a vertical gap 25mm wide between a panel and a wall. Leave a 25mm wide vertical gap between each panel. For WC panels, leave 50mm for fixing a cubicle partition. Plain panel packs P3 and P4 can be cut down and re-edged on site to cater for ranges that do not accommodate 700mm modules.

For more information on junction details visit our website www.bushboard-washrooms.co.uk

Please note for each panel you will need one flash gap pack.



Options

- Children's door instead of standard door pack
- Door packs and in-line packs available with square edge pilaster or postformed pilaster
- Ambulant/enlarged grab rails and door opening bars are available separately



Freestanding

No. Cubicles	1	2	3	4	5	6	7	8
Door Pack	1	2	3	4	5	6	7	8
Fittings Pack	1	2	3	4	5	6	7	8
Partition Pack	2	3	4	5	6	7	8	9
Floor/Ceiling post pack	1	1	1	2	2	2	2	2
Max. Width (mm)	1060	2120	3180	4240	5300	6360	7420	8480

Inline Cubicles	Between Walls	Against Walls
	No. Cubicles	1
Door Pack	1	1
Fittings Pack	1	1
Partition Pack	0	1
Inline Pack	1	1
Max. Length (mm)	2000	2000
Min. Cubicle Width 750mm.		

3. Vanity Selection

- Determine how many vanity basins you require in each top.

1500mm long top	Up to 2 basins	Pack V1
-----------------	----------------	---------

- Check that the vanity top will fit into the available space
- The vanity pack includes under panel, return end, flashgap and a fixing kit
- Supporting timber framework to be supplied by site

LOCKERS

Protec® SGL changing room lockers are the durable and robust option when it comes to challenging environments, including leisure facilities, campsites and commercial washrooms. The strong Solid Grade Laminate (SGL) carcass is watertight and corrosion-proof.

Each individual locker has an easy to clean SGL shelf, and anti-finger trap safety hinge to doors. With Protec®, it's simple. Choose your locker style, choose your locking system and select your door colour using our Colour Selector.

You can choose any combination of the locker models to suit your installation, and they are delivered assembled and ready to install. For wet areas, we suggest an additional base.

We offer a range of lock options to suit most environments.

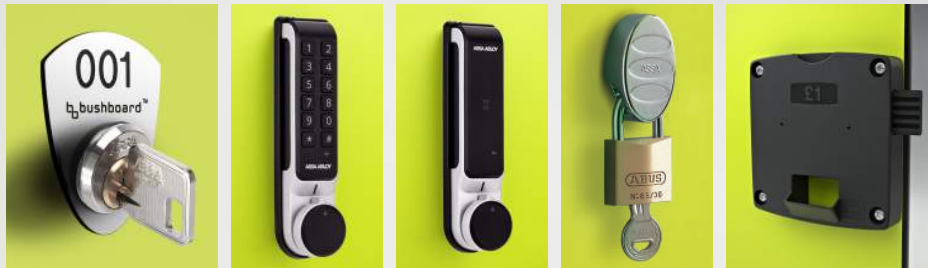

Camlock Digi Lock RFID Lock* Padlock and hasp Coin return & Coin Retain Available

For further information visit www.bushboard-washrooms.co.uk

* Radio-frequency identification lock supplied with touch card



TECHNICAL

Panel

SGL for total water resistance and exceptional durability

Locker Shelf

Light Grey Solid Grade Laminate

Coat Hook

Integral coat hook to maximise internal space (supplied as standard with model 1, model 2 and Z lockers)

Doors

SGL doors with integrated hinge design

Locks

Choice of lock options

Carcass

Solid Grade Laminate

Widths

Overall locker size in 2 widths – 300mm and 400mm
*Z locker available in 400mm only

Height

Overall locker height is 1800mm
Overall locker depth is 500mm



SGL Carcass Dimensions

Model Z – 1462 x 392mm

Model 1 – 1776 x 292mm
(392 when 400 wide)

Model 2 – 882 x 292mm
(392 when 400 wide)

Model 3 – 582 x 292mm
(392 when 400 wide)

Model 4 – 438 x 292mm
(392 when 400 wide)

Model 5 – 348 x 292mm
(392 when 400 wide)

BENCHES

Our benches have been selected to provide the most popular styles for all types of installations.



Locker Bench

ISLAND BENCH

The Island Bench is available in 13mm SGL Solid, 13mm SGL with slots and 32mm Hardwood (Beech). The bench is complete with a steel welded powder coated tubular frame and adjustable nylon feet with hidden floor fixings. Slats lengths available in three modular lengths; 900mm, 1600mm and 2300mm. Shoe Rack available with this bench option.

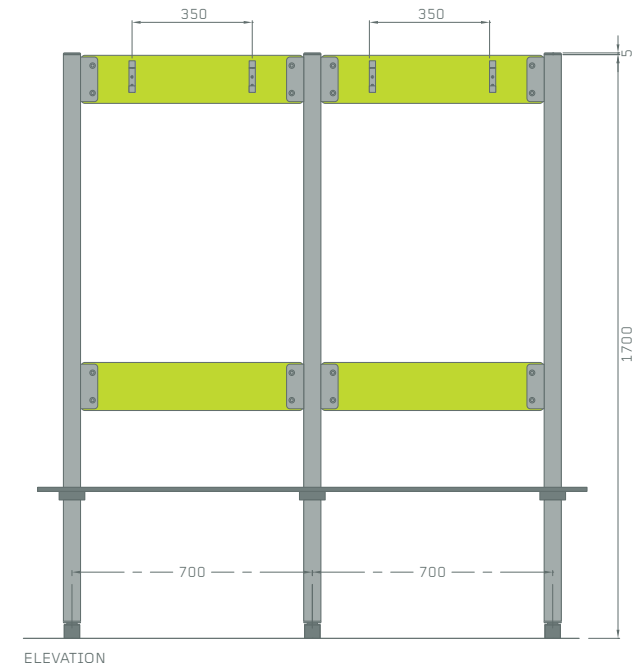
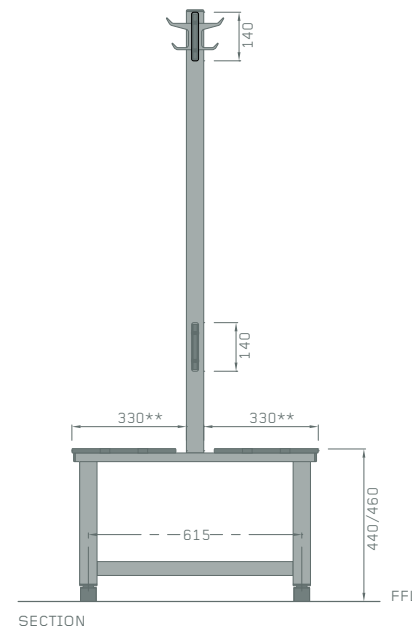
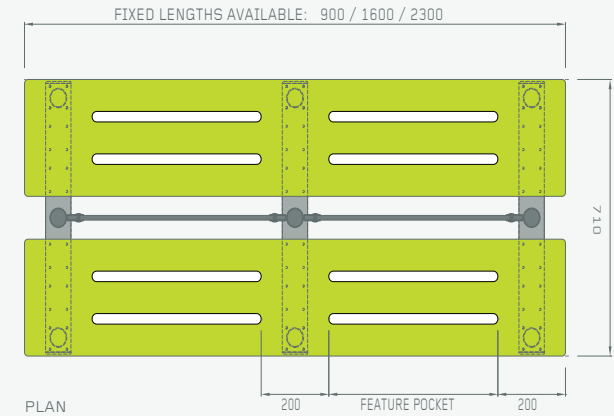

image shows the 13mm SGL with slots in 1600mm length

CANTILEVER BENCH

The cantilever bench is designed to be fixed into solid walls. Available in 13mm SGL Solid, 13mm SGL with slots and 32mm Hardwood (Beech) wooden slats. This durable bench is complete with a steel welded powder coated tubular frame. Available in lengths to suit room layouts or cubicle widths.

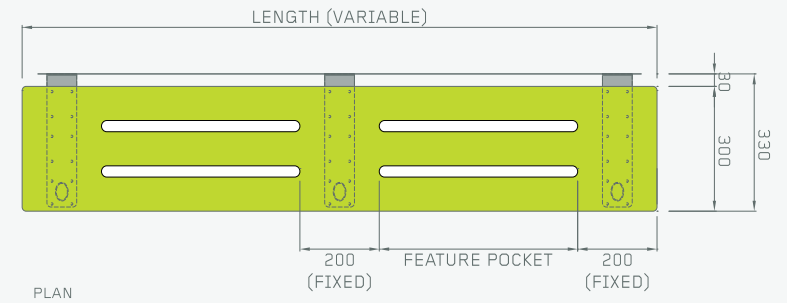
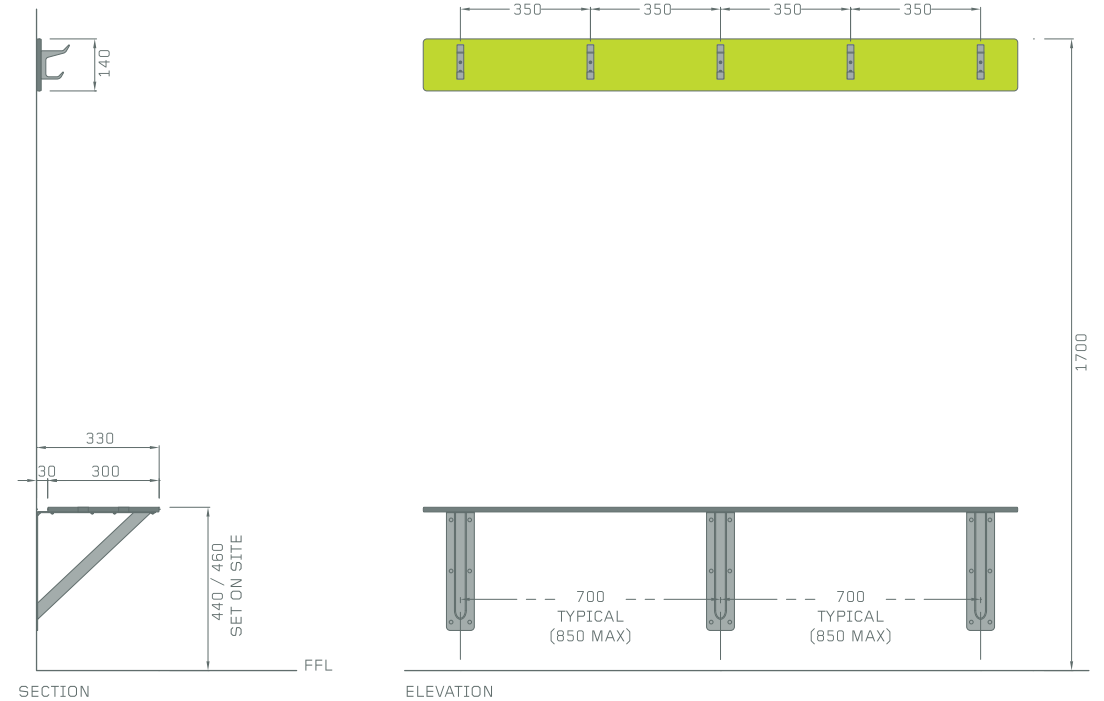

image shows the 13mm SGL with slots



FREESTANDING BENCH

The Freestanding Bench is available in 13mm SGL Solid, 13mm SGL with slots and 32mm Hardwood (Beech). The bench is complete with a steel welded powder coated tubular frame and adjustable nylon feet with hidden floor fixings. Slats lengths available in 900mm, 1600mm and 2300mm. Available with Anti-Peep Rail, Wall Mounted Coat Rail and Shoe Rack with this bench option.

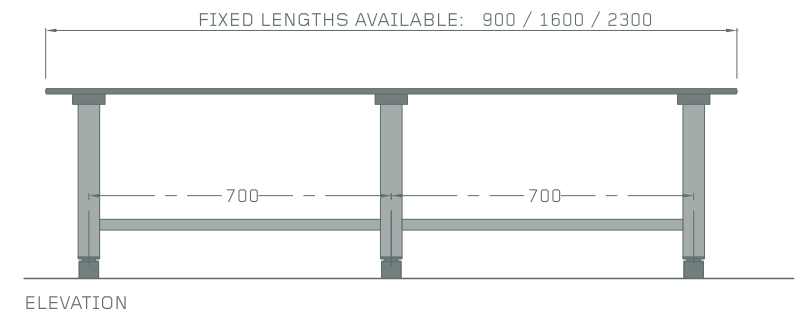
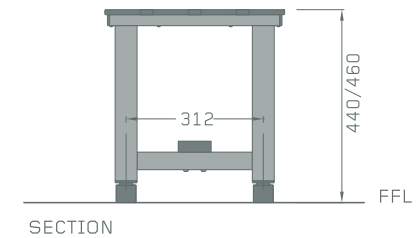
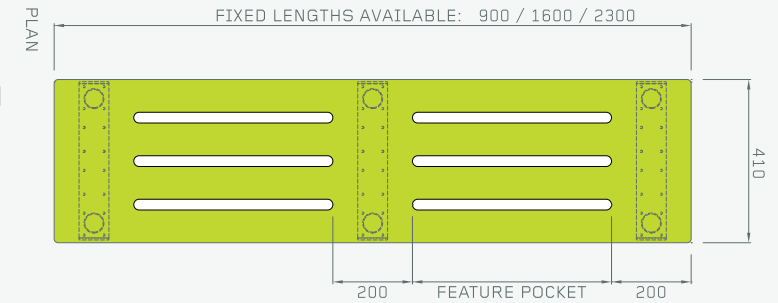

image shows the 13mm SGL with slots

PERIMETER BENCH

The Perimeter Bench is available in 13mm SGL Solid, 13mm SGL with slots and 32mm Hardwood (Beech). The bench is complete with a steel welded powder coated tubular frame and adjustable nylon feet with hidden floor fixings. Available in a variety of lengths to suit rooms layout. This bench type is perfect for use within changing cubicles and can be specified with Anti Peep Rails if required. Also available with shoe rack and wall mounted coat rail.

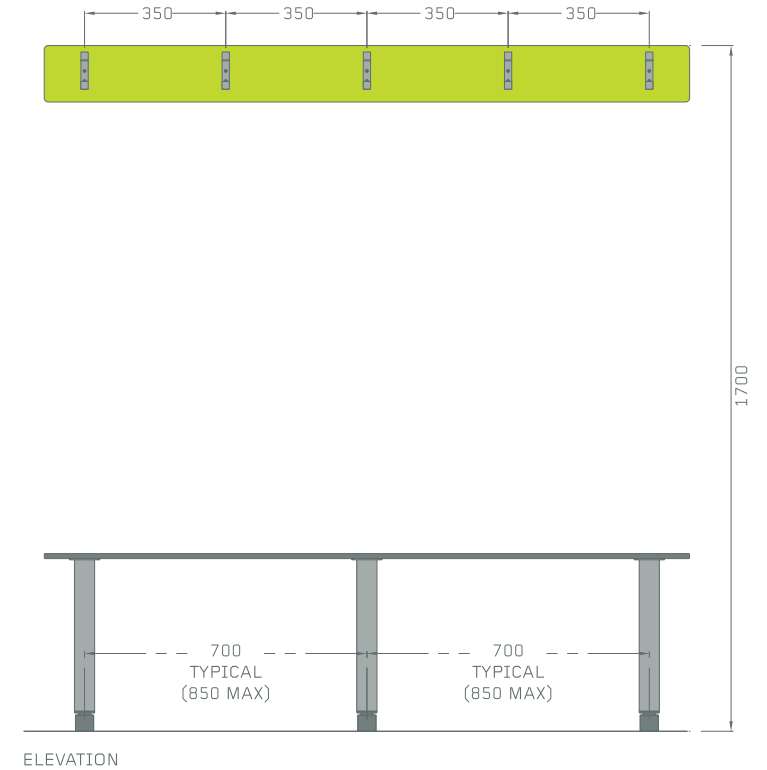
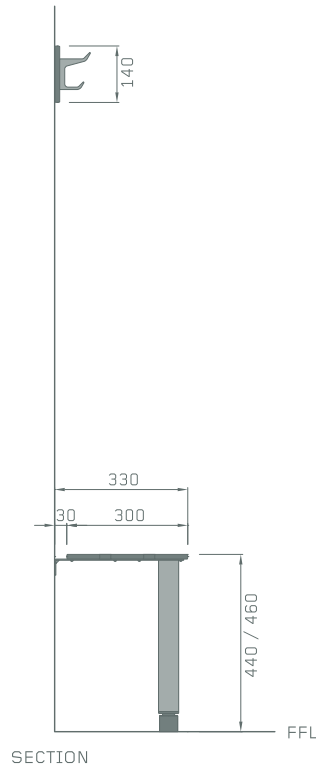
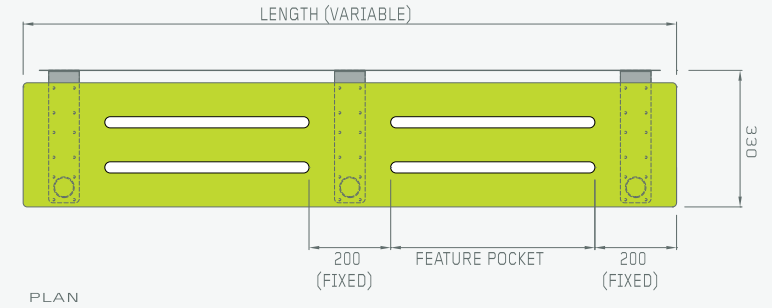

image shows the 13mm SGL with slots

LOCKER BENCH

The Locker Bench is cost-effective and can help make the best use of the space. Available in 13mm SGL Solid, 13mm SGL with Slots and 32mm Hardwood (Beech).

The bench is complete with a steel welded powder coated tubular frame for strength and durability. Features also include adjustable nylon feet with hidden floor fixings. Available in set lengths to suit chosen locker layout.

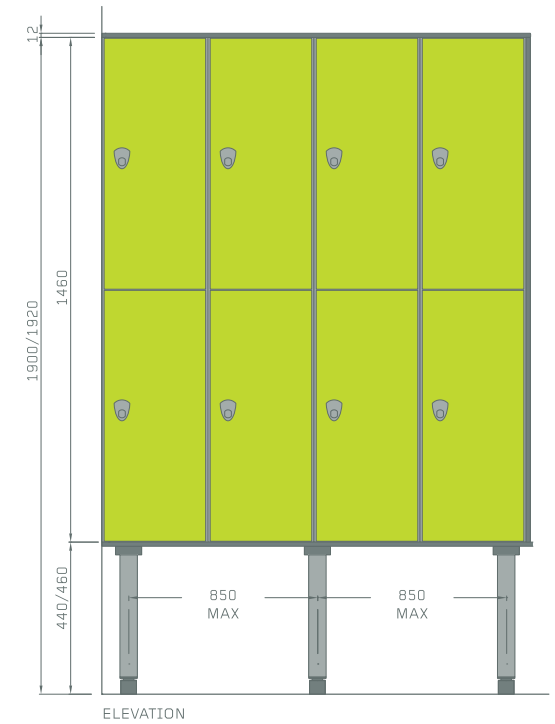
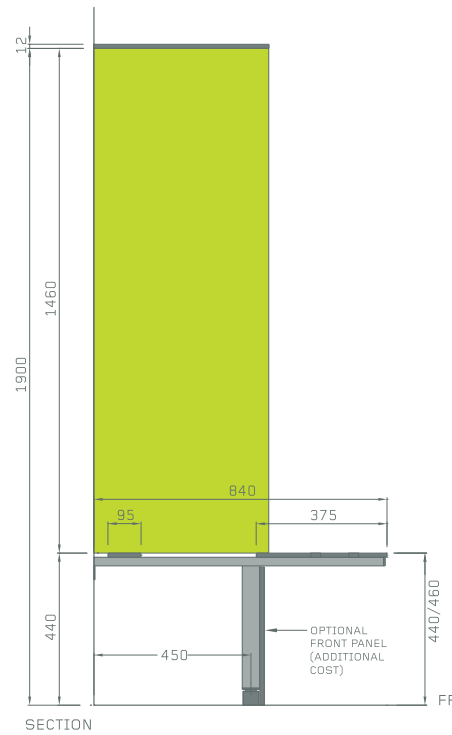
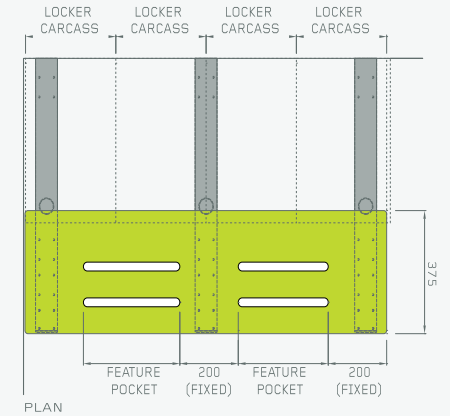

image shows the 13mm SGL with slots

ACCESSORIES



White Plastic Liquid Soap Dispenser
0302540

Wall mounted. White plastic dispenser.



ABS Liquid/Foam Soap Dispenser
0302513/4

Wall mounted plastic dispenser with Stainless Steel cover.



Cylindrical Liquid Soap Dispenser
0302508

Wall mounted. Stainless Steel with chrome finish.



Top Mounted Liquid Soap Dispenser
0302532

Polished chrome finish.



Nylon Coat Hook
0300137/39

Dark Grey/Light Grey. Lightweight nylon with concealed fixings.



Stainless Steel Warm Air Hand dryer
0302019

Automatic warm air hand dryer with brushed Stainless Steel finish.



Slimline Warm Air Hand Dryer
0302520

Stainless Steel and black finish.



Automatic Jet Hand Dryer
0302536

High speed jet hand dryer with silver cover. Low energy consumption.



White Metal Warm Air Hand Dryer
0302005

Automatic warm air hand dryer with white metal finish.



Automatic High Speed Hand Dryer
0302533/5

White Metal/Aluminium. Compact high speed hand dryer. Low energy consumption.



White Plastic Paper Towel Dispenser
0302537

Wall mounted, white plastic paper towel dispenser.



ABS Paper Towel Dispenser
0302519

Wall mounted plastic dispenser with Stainless Steel cover.



Stainless Steel and White Metal Paper Towel Dispenser
0302526/22

Lockable, wall mounted paper towel dispenser.



Nylon Toilet Roll Holder
0300303/0300146

Light Grey/Dark Grey. Single nylon toilet roll holder with concealed fixings. Also available as lockable.



Aluminium Toilet Roll Holder
0380070

Satin Chrome.



White Lockable Toilet Tissue Dispenser
0302539

Wall mounted, white plastic toilet tissue dispenser.



Jumbo Stainless Steel/White Metal Toilet Roll Holder
0302500/0302523

Stainless Steel/White Metal. Wall mounted, lockable, jumbo toilet roll holder.



ABS and Stainless Steel Toilet Tissue Dispenser
0302517

Wall mounted, plastic and Stainless Steel toilet tissue dispenser.

WC Door Signs
0302503/04/05/06/07

Male/Female/Unisex/Disabled/Baby Change.



Outward Opening Aluminium Door Handle 400mm
0182225

Satin Anodised.



Outward Opening Stainless Steel Door Handle 400mm
0182208/03

Polished Chrome/Satin.



Stainless Steel Toilet Brush Holder
0302512

Stainless steel finish.

For a full range of accessories, visit www.bushboard-washrooms.co.uk

To order spare parts and accessories direct, visit www.bushboard-washrooms-spares.co.uk

PERFORMANCE & DELIVERY

Melamine Faced Chipboard – MFC

Light to medium use – Dry

High performance Melamine Faced Chipboard 650kg/m³ density, moisture resistant, suitable for dry environments with light to medium use. Panels supplied square edged with matching 1mm PVC lipping.

High Pressure Laminate – HPL

Medium use – Dry

High Pressure Laminate bonded onto 680kg/m³ density, moisture resistant chipboard, suitable for dry environments with more intense use. Panels supplied square edged with matching 1mm PVC lipping or postformed vertical edges.

- All lipping is applied with PUR adhesive
- Real Wood Veneer, ColourCoat™, MFC and HPL are not suitable for use in wet environments

See our separate Colour Selector for our full range of panel colour options.

Solid Grade Laminate – SGL

Heavy use – Wet or dry

High density Solid Grade Laminate, 1400kg/m³ impervious to water, suitable for the most demanding environments where strength and/or water resistance are needed. Polished radiused black edges as standard.

Real Wood Veneer

Light to medium use – Dry

MDF faced both sides with Real Wood Veneer, suitable for dry environments with light to medium use. Panels supplied square edged with 3mm Real Wood Veneer lipping.

ColourCoat™

Light to medium use – Dry

High performance MDF sprayed with 2 coats of liquid primer and finished with 2 coats of ColourCoat™ pigmented lacquer.

Solid Surface

Heavy use – Wet or dry

Solid surface is manufactured from an advanced composition of minerals and acrylic polymer that delivers a seamless finish to vanity tops and is exceptionally hardwearing.



MFC – Melamine Faced Chipboard



HPL – High Pressure Laminate



SGL – Solid Grade Laminate



Real Wood Veneer

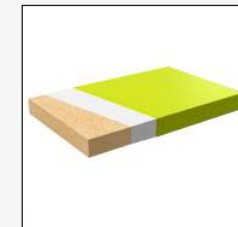

Colourcoat™



Solid Surface

Vanity Units

As well as High Pressure Laminate and Solid Grade Laminate, vanity tops are also available in Solid Surface.

Delivery

Here at Bushboard, we are committed to ensuring your order is delivered on time, in full and in perfect condition. With this in mind we have invested in the latest manufacturing technology to ensure the entire process; from order to delivery; is as efficient as possible.

All of our panels are manufactured to your specific site dimensions and full CAD drawings are supplied with delivery. You also have the option to receive drawings for your approval prior to manufacture.

ENVIRONMENTAL

We understand the social and economic importance of protecting the environment and are fully committed to continually improving our environmental performance.



We regularly assess the environmental impact of our business operations and take appropriate action to minimise any adverse impacts. Some of our resulting initiatives include:

Paperless Systems – All of our quotes are emailed and our brochures are available electronically so we only print when absolutely necessary.

Zero Landfill – Here at Bushboard, we are proud of our contribution towards a greener planet. We ensure that all board waste is kept to a minimum and any waste that is produced is used as fuel for our biomass boiler, meaning zero board waste is sent to landfill.

FSC – The Real Wood Veneer used in our products is FSC® certified, meaning the wood we use is from sustainable forests.

Reducing Carbon Emissions – We have installed video conferencing facilities across all of our sites in order to minimise business travel.



The mark of responsible forestry



Bushboard Washroom Systems Ltd

Unit 1400 1st Floor Montagu Court
Kettering Parkway
Kettering Venture Park
Kettering
NN15 6XR

T +44 (0)1536 533 620

E washrooms@bushboard-washrooms.co.uk

www.bushboard-washrooms.co.uk

After Sales and Customer Care: T +44 (0)1536 533 620

All colours shown in this brochure are as accurate as the printing process allows.
Bushboard Washroom Systems Ltd reserves the right to alter or change specifications without notice.

© Bushboard Washroom Systems Ltd 2021.