

FAST TRACK

A complete off-the-shelf washroom in 48 hours



FAST TRACK

A complete off-the-shelf washroom in 48 hours

Fast Track is one of the most comprehensive fast-delivery washroom ranges available. Including cubicles, ducting and vanity units, Fast Track is a stylish, durable and economical washroom for dry areas, delivered box packed for easy handling. Panels are cut to size on-site and edges concealed in continuous channels.

A stylish and economical cubicle featuring durable dark grey fixtures and fittings. A choice of square edge or postformed pilasters is available as well as a children's height door and the option of enlarged and ambulant cubicles.

Finish	Laminate
Performance	MFC
Pilasters	Square edge with matching 1mm PVC lipping
Fittings	Dark Grey
Standard Height	1950mm (including floor clearance)
Floor Clearance	100mm
Colours	6 Colour options for all panels

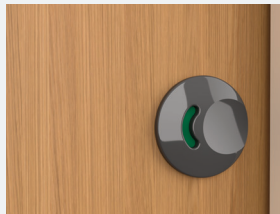

Faceplate

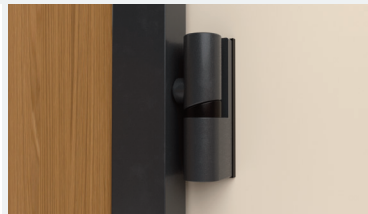

Hinge



Pedestal Foot

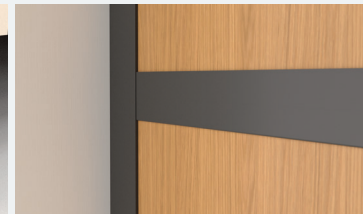

Wall Channel and H Section





ABOVE – FAST TRACK CUBICLES

Doors: Oak | **Pilasters:** Sand | **Fittings:** Charcoal | **Vanity:** Counter Top Vanity Unit in Oak with Sand undervanity and Oak panels | **Basin:** Shenley 500 Counter Top Basin | **Tap:** Langley Mono Basin Mixer Tap

FAST TRACK CUBICLES

- All components delivered to standard dimensions, boxed and clearly labelled
- Partitions and doors can be cut to size on site and edges concealed in channels
- Channels accommodate out of line walls
- Packs include detailed installation instructions

C1 Door Pack with Pilasters

Outward opening/inward opening Wheelchair, Ambulant and Enlarged

- 1 door 1850 x 900mm
- 1 pilaster 1850 x 220mm
- 1 pilaster drilled for hinge 1850 x 115mm
- 1 pilaster no hinge 1850 x 115mm
- 1 pilaster for enlarged cubicle drilled for hinge 1850 x 400mm
- 3 UPVC door cap/wall channels 1850mm
- 1 Aluminium headrail – Dark Grey 1800mm

C1C Children's Door Pack with Pilasters

- 1 door 1850 x 900mm
- 1 pilaster 1850 x 220mm
- 1 pilaster drilled for hinge 1850 x 115mm
- 1 pilaster no hinge 1800 x 115mm
- 1 pilaster for enlarged cubicle drilled for hinge 1850 x 400mm
- 3 UPVC door cap/wall channels 1850mm
- 1 aluminium headrail – Dark Grey 1800mm

C2 Partition Pack

- 2 partitions "halves" 925 x 1800mm
- 1 UPVC H section 1750mm
- 1 UPVC door cap/wall channel 1850mm

C3 Inline Pack with Pilasters

- 1 large pilaster 1850mm x 900mm
- 1 pilaster drilled for hinge 1850 x 550mm
- 1 aluminium headrail – Dark Grey 1800mm

C1FB Fittings Pack

- 1 polycarbonate indicator bolt
- 1 outward keep
- 3 hinges Dark Grey
- 1 toilet roll holder
- 1 coat hook
- 1 polycarbonate pedestals
- Screws, plugs and channel through fixings

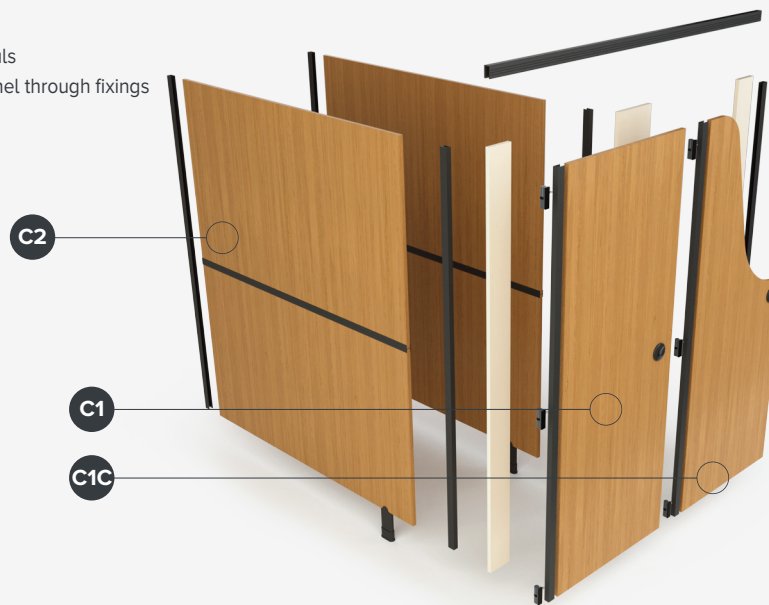

C4 Floor to Ceiling Post

Required when ordering free standing cubicles.

- 1 floor to ceiling post 3750mm
- 2 flanges
- 1 UPVC door cap/wall channel 1850mm
- Screws, plugs and channel through bolt fixings

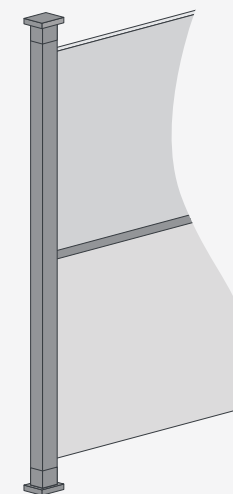

FAST TRACK DUCT PANELS

Fast Track duct panels can incorporate most standard sanitaryware items.

- All components delivered to standard dimensions, boxed and clearly labelled
- Duct widths and heights can be varied by adjusting width of flashgaps
- Installer to provide appropriate timber frame to support duct panels (typically 50mm x 50mm softwood frame)
- Packs include detailed installation instructions

Shelf Height

P4 Plain Panel

- 1 plain panel 2250 x 300mm

Plain Panel/Return End

- 1 plain panel 2250 x 300mm

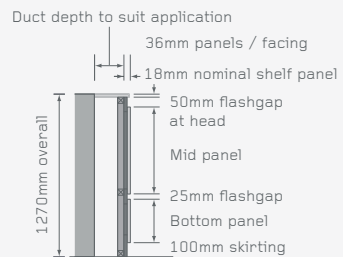

Standard Height

F1 Flashgap Pack

- 2 flashgaps – unedged 2600 x 200mm
- 1 flashgap – edged 2600 x 201mm
- 16 shrinkage plates and screws

P1 Washbasin/WC Panel Pack

- 1 bottom panel 405 x 700mm
- 1 middle panel 670 x 700mm
- 1 top panel 1125 x 700mm
- 1 x 1mm PVC re-edging strip 2500mm
- 16 plastic clips and screws

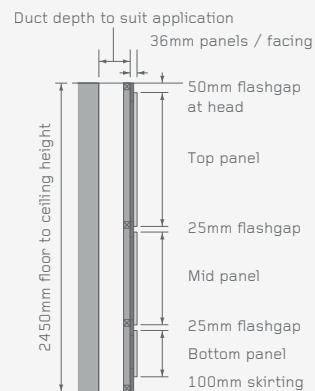

P2 Urinal Panel Pack

- 1 bottom panel 225 x 700mm
- 1 middle panel 850 x 700mm
- 1 top panel 1125 x 700mm
- 1 x 1mm PVC re-edging strip 2500mm
- 16 plastic clips and screws

P3 Plain Panel

- 1 plain panel 2250 x 700mm
- 1 x 1mm PVC re-edging strip 2500mm
- 10 plastic clips and screws

P4 Plain Panel

- 1 plain panel 2250 x 300mm
- 1 x 1mm PVC re-edging strip 2500mm
- 10 plastic clips and screws



FAST TRACK VANITIES

Fast Track vanity units can incorporate most standard sanitaryware items.

- All components delivered to standard dimensions, boxed and clearly labelled
- For longer lengths, units can be butt jointed/cut to length on site
- Packs inclusive of detailed installation instructions

Performance	Vanity top: HPL	
	Vanity underpanel: MFC	
Colours	6 colour options for all panels	
Service	Fast Track	
Upstand	Integral upstand	
Dimensions	Length	1500mm
	Bed Depth	555mm
	Downstand	100mm

V1 Vanity Unit

- 1375 x 555mm top with 75mm postformed upstand and 100mm downstand, returns and support brackets
- 2 loose underframe return ends 750 x 455mm
- 1 under panel 1245 x 645mm
- Clips and screws
- 3 unedged flashgaps 1300 x 200mm
- 1 x 1mm PVC re-edging strip 1000mm

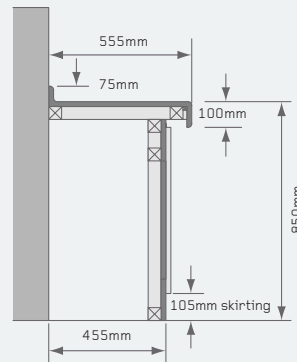
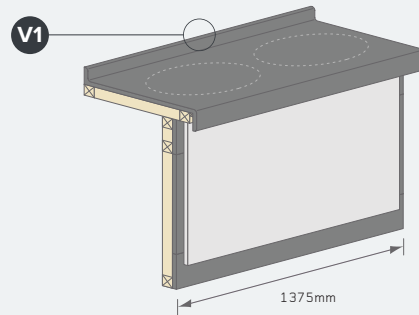

Fast Track Colours

Our colours are graded with a light reflective value (LRV) to help ensure your washroom complies with current legislation*.



Blue
LRV 20



Green
LRV 66

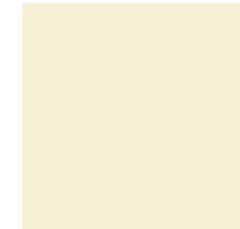

Sand
LRV 66

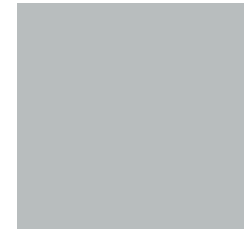

Light Grey
LRV 37



Dark Grey
LRV 10

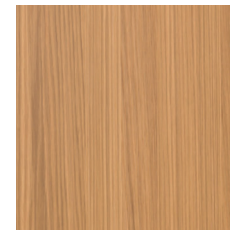

Oak
LRV 36



Faceplate
Dark Grey

Cubicle Fittings



Nylon Toilet Roll Holder



Nylon Coat Hook



Internal Grab Rail

* Contact your local access control officer.

A step by step guide to selecting your Fast Track washroom packs.

Call our friendly sales team who will help process your order on 01536 533620.

1. Cubicle selection

- Identify the layout of the cubicles you require from these four options and refer to the table next to it
- Identify the number of cubicles you require along the top row of the grid
- Read down the column to determine the pack and quantity you require

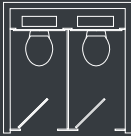

Between walls

No. Cubicles	1	2	3	4	5	6	7	8
Door Pack	1	2	3	4	5	6	7	8
Fittings Pack	1	2	3	4	5	6	7	8
Partition Pack	0	1	2	3	4	5	6	7
Floor/Ceiling post pack	0	0	0	0	0	0	0	0
Max. Width (mm)	1060	2120	3180	4240	5300	6360	7420	8480



Against walls

No. Cubicles	1	2	3	4	5	6	7	8
Door Pack	1	2	3	4	5	6	7	8
Fittings Pack	1	2	3	4	5	6	7	8
Partition Pack	1	2	3	4	5	6	7	8
Floor/Ceiling post pack	0	0	0	0	0	0	0	0
Max. Width (mm)	1060	2120	3180	4240	5300	6360	7420	8480

2. Ducting selection

- For each range of panels determine how many you want of each type
- Check they will fit in the space available

Please note: Always leave a vertical gap 25mm wide between a panel and a wall. Leave a 25mm wide vertical gap between each panel. For WC panels, leave 50mm for fixing a cubicle partition. Plain panel packs P3 and P4 can be cut down and re-edged on site to cater for ranges that do not accommodate 700mm modules.

For more information on junction details visit our website www.bushboard-washrooms.co.uk

Please note for each panel you will need one flash gap pack.

Options

- Children's door instead of standard door pack
- Door packs and in-line packs available with square edge pilaster or postformed pilaster
- Ambulant/enlarged grab rails and door opening bars are available separately



Freestanding

No. Cubicles	1	2	3	4	5	6	7	8
Door Pack	1	2	3	4	5	6	7	8
Fittings Pack	1	2	3	4	5	6	7	8
Partition Pack	2	3	4	5	6	7	8	9
Floor/Ceiling post pack	1	1	1	2	2	2	2	2
Max. Width (mm)	1060	2120	3180	4240	5300	6360	7420	8480



Inline Cubicles

	Between Walls	Against Walls
No. Cubicles	1	1
Door Pack	1	1
Fittings Pack	1	1
Partition Pack	0	1
Inline Pack	1	1
Max. Length (mm)	2000	2000

Min. Cubicle Width 750mm.

3. Vanity Selection

- Determine how many vanity basins you require in each top.

1500mm long top	Up to 2 basins	Pack V1
-----------------	----------------	---------

- Check that the vanity top will fit into the available space
- The vanity pack includes under panel, return end, flashgap and a fixing kit
- Supporting timber framework to be supplied by site