



Aluminium entrance doors

For elegant entrances in a safe and beautiful home

HÖRMANN





CONTENT

- 4 Programme overview
- 6 Design overview
- 8 Good reasons to try Hörmann
- 14 Security equipment
- 17 ThermoSafe, ThermoSafe Hybrid
- 49 ThermoPlan Hybrid
- 61 ThermoCarbon
- 75 TopComfort
- 81 Special equipment
- 90 Lock variants ThermoSafe, ThermoSafe Hybrid
ThermoPlan Hybrid, ThermoCarbon
- 99 Hörmann product range

The colours and surface finishes shown are subject to the limitations of the printing process and cannot be regarded as binding.

Some of the products and equipment details described and illustrated in this catalogue are not standard, but available for a surcharge. Descriptions and pictures, information about the scope of delivery, equipment and colour correspond to the time of printing. Subject to changes and errors.

All rights reserved. No part may be reproduced without our prior permission.

◀ **ThermoSafe style 860** in the standard colour Traffic white RAL 9016, matt, with side elements

Hörmann brand quality impresses in every version

Hörmann aluminium entrance doors are superior to plastic or timber doors in many ways. These benefits will convince you:

- High thermal insulation
- High security
- High acoustic insulation
- Great stability
- No follow-up painting necessary

Hörmann entrance doors look new even after many years, and also offer you a large variety of options with regard to technical equipment and design. Five entrance door versions from Europe's no. 1 are available for you to choose from. Discover your new entrance door!



Exclusive class: ThermoSafe

Our best-selling aluminium entrance doors ThermoSafe are characterised by a **large selection of styles**.

Top class: ThermoSafe Hybrid

ThermoSafe Hybrid entrance doors ensure particularly high leaf rigidity and dimensional stability thanks to the stainless steel sheet on the door leaf exterior.

Learn more about our ThermoSafe doors from page 17

Learn more about our ThermoSafe Hybrid doors from page 17



Design class: ThermoPlan Hybrid

The ThermoPlan Hybrid door combines the benefits of stainless steel and aluminium for a special door view thanks to a flush transition between the frame and door leaf.

Learn more about our ThermoPlan Hybrid doors from page 49



Premium class: ThermoCarbon

The thermal insulation world champion among aluminium entrance doors is characterised by a 100-mm-thick door leaf with a high-tech leaf profile made of carbon glass-fibre.

Further advantages of the ThermoCarbon doors can be found from page 61



Comfort class: TopComfort

This entrance door complies with all your demands for maximum light thanks to its extensive glazing.

Discover all the possibilities from page 75



Top class: Thermo65

Thanks to standard multiple-point locking, these inexpensive entrance doors give you a feeling of security, save energy through excellent thermal insulation and provide a stylish appearance for your home.



More information can be found in the "Entrance doors Thermo65 / Thermo46" brochure.

* Recommended retail price incl. 16 % VAT

ThermoSafe / ThermoSafe Hybrid



Style 40
Page 39



Style 45
Page 21

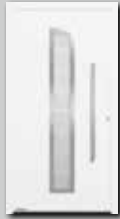

Style 65
Page 21



Style 75
Page 21



Style 110
Page 23



Style 136
Page 38



Style 138
Page 23
■ NEW



Style 140
Page 23



Style 166
Page 38



Style 173
Page 45



Style 176
Page 37



Style 177
Page 37



Style 185
Page 21



Style 188
Page 45



Style 189
Page 26



Style 402
Page 41



Style 413
Page 41



Style 445
Page 41



Style 501
Page 25



Style 502
Page 25



Style 503
Page 26



Style 504
Page 25



Style 505
Page 25



Style 514
Page 34



Style 524
Page 34



Style 551
Page 39



Style 552
Page 39



Style 553*
Page 39



Style 560
Page 38



Style 565
Page 30



Style 568
Page 30



Style 583
Page 39



Style 590*
Page 39



Style 650
Page 23



Style 675
Page 41



Style 680
Page 22



Style 686
Page 26



Style 689
Page 32



Style 693
Page 32



Style 694
Page 41



Style 697
Page 38



Style 723
Page 29



Style 757
Page 35



Style 759
Page 35



Style 777
Page 35

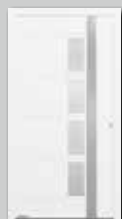

Style 779
Page 35



Style 797
Page 37



Style 799
Page 37



Style 823
Page 29



Style 832
Page 30



Style 836
Page 30



Style 860
Page 26



Style 861
Page 32



Style 862
Page 27



Style 867
Page 27



Style 871
Page 27



Style 872
Page 27



Style 877
Page 34



Styles
825 / 845 / 855
Page 42



Styles
875 / 895 / 898
Page 42



Style 879
Page 34



Style 891*
Page 32

ThermoPlan Hybrid

ThermoCarbon

TopComfort



Style 138
Page 53



Style 189
Page 53



Style 501
Page 54



Style 189
Page 65



Style 300
Page 66



Style 301
Page 66



Style 302
Page 68



Style 100
Page 78



Style 101
Page 78



Style 502
Page 54



Style 503
Page 53



Style 504
Page 54



Style 304
Page 71



Style 305
Page 71



Style 306
Page 68



Style 308
Page 71

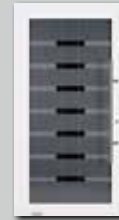

Style 100
MG 111
Page 78



Style 100
MG 112
Page 78



Style 505
Page 54



Style 686
Page 53



Style 823
Page 55
■ NEW



Style 309
Page 71



Style 310
Page 68



Style 312
Page 68



Style 314
Page 68



Style 100
MG 113
Page 79



Style 100
MG 114
Page 79



Style 860
Page 53



Style 862
Page 56



Style 867
Page 56



Style 504
Page 65



Style 565
Page 66



Style 568
Page 66



Style 650
Page 65



Style 100
MG 115
Page 79



Style 100
MG 116
Page 79



Style 871
Page 56



Style 872
Page 56



Style 680
Page 65



Style 686
Page 65



Style 823
Page 69
■ NEW



Style 860
Page 70



Style 100
MG 117
Page 79



Style 862
Page 65

Configurator

With the door configurator, you can conveniently test many design and product variations on your own PC or tablet in advance. You can put together your dream door in just a few clicks by selecting the door programme, style, colour and size.



The Hörmann configurator can be found on our website.

“A good reputation must be earned.”

August Hörmann

In keeping with the tradition started by the company's founder, the name Hörmann delivers brand name quality with extensive product expertise. The family business has over 80 years of experience as a construction component specialist and sees itself as your partner from the very beginning of building and renovation projects. It's no surprise that Hörmann is one of Europe's most successful entrance door providers. All of this gives you a good feeling when you purchase a Hörmann entrance door.



1 Made in Germany

All doors are developed and manufactured by Hörmann. Our highly qualified employees work intensively on new products, continual further developments and improvements to details. The results are patents and unique products on the market. Endurance tests under real conditions **ensure mature series products with Hörmann quality.**

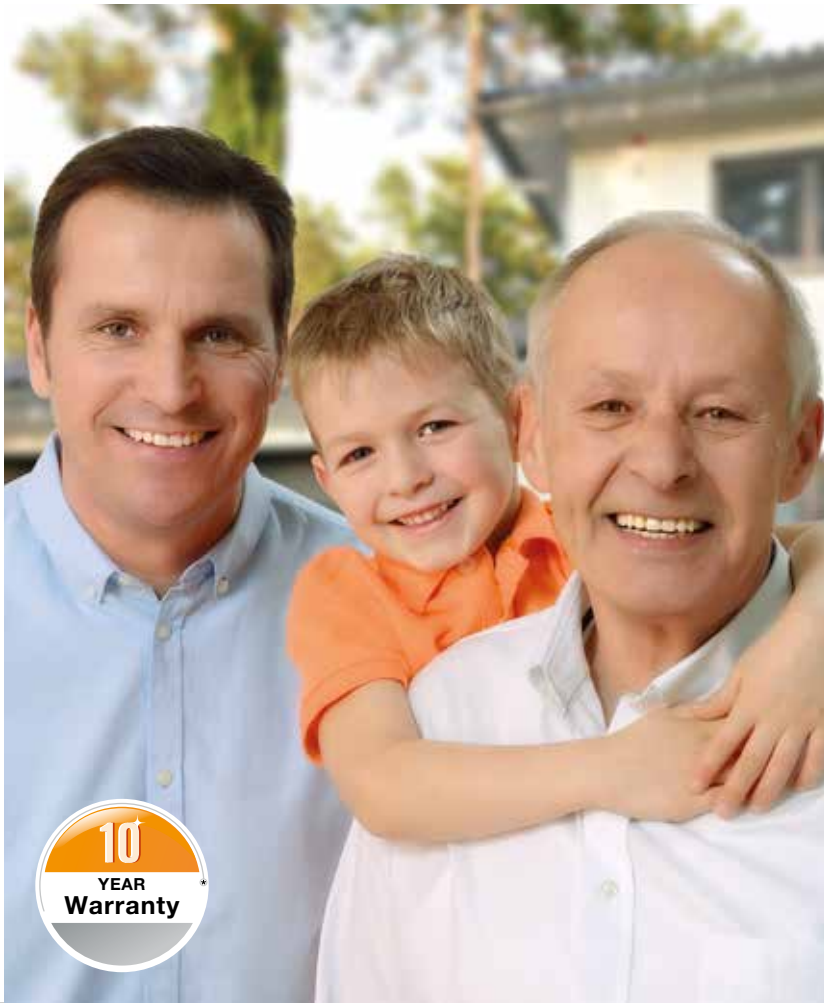

2 Quality products for generations

We are convinced of our products and our uncompromising quality assurance. That is why we at Hörmann issue a **10-year guarantee*** on **ThermoSafe, ThermoSafe Hybrid, ThermoPlan Hybrid, ThermoCarbon and TopComfort entrance doors.**

3 An eye on the future

Hörmann is setting a good example. This is why the company obtains **100 % of its energy consumption from green sources.** Together with an intelligent and certified energy management system, CO₂-neutral mailing and the recycling of valuable materials, more than **40000 tons of CO₂ are saved each year.** And last but not least, Hörmann also offers products for sustainable construction.

* The complete warranty conditions can be found at: www.hoermann.com

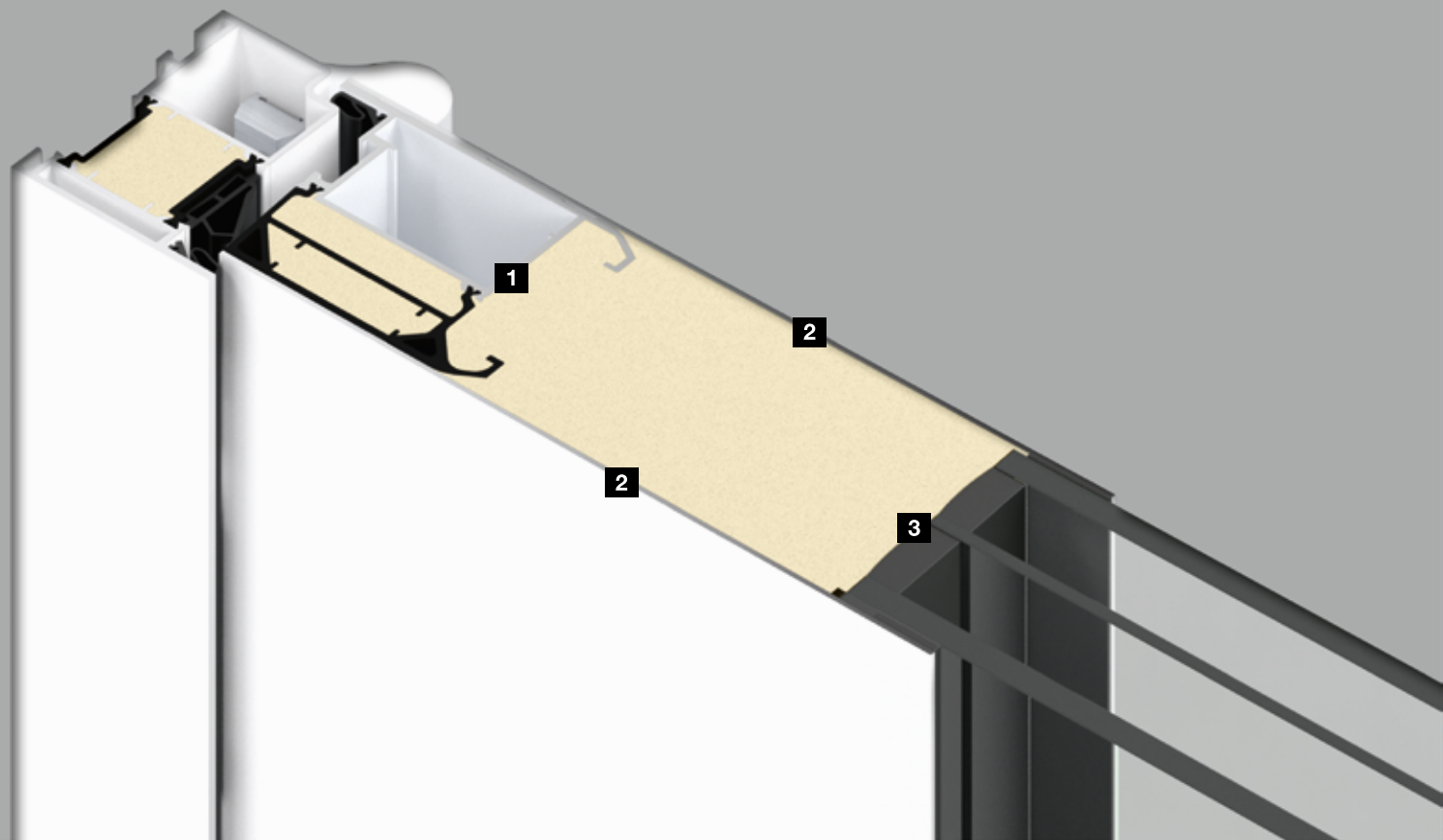

4 Fully foamed door leaf construction



Only from Hörmann

No thermal bridges for glazings

For ThermoSafe, ThermoSafe Hybrid, ThermoPlan Hybrid and ThermoCarbon entrance doors, the entire door leaf is delivered fully foamed. This way, the PU foam is optimally bonded to the door profile **1**, the internal and external sheets **2** and the glazing **3**. In contrast to other door systems, where the components are only glued together, this construction is characterised by a particularly high dimensional stability and break-in resistance as well as even better thermal insulation, as no thermal bridges are created.



Exterior view



Interior view

5 Door leaf without visible leaf profile

Our ThermoSafe, ThermoSafe Hybrid, ThermoPlan Hybrid and ThermoCarbon entrance doors give you an exquisite and elegant reception. The shapely **door leaf with its solid interior and exterior** and leaf profile on the inside fulfils the highest design requirements. The interior view harmonises perfectly with your residential internal doors.



External view of entrance doors from other manufacturers with visible leaf profile



Interior view of entrance doors from other manufacturers with visible leaf profile and glazing beads

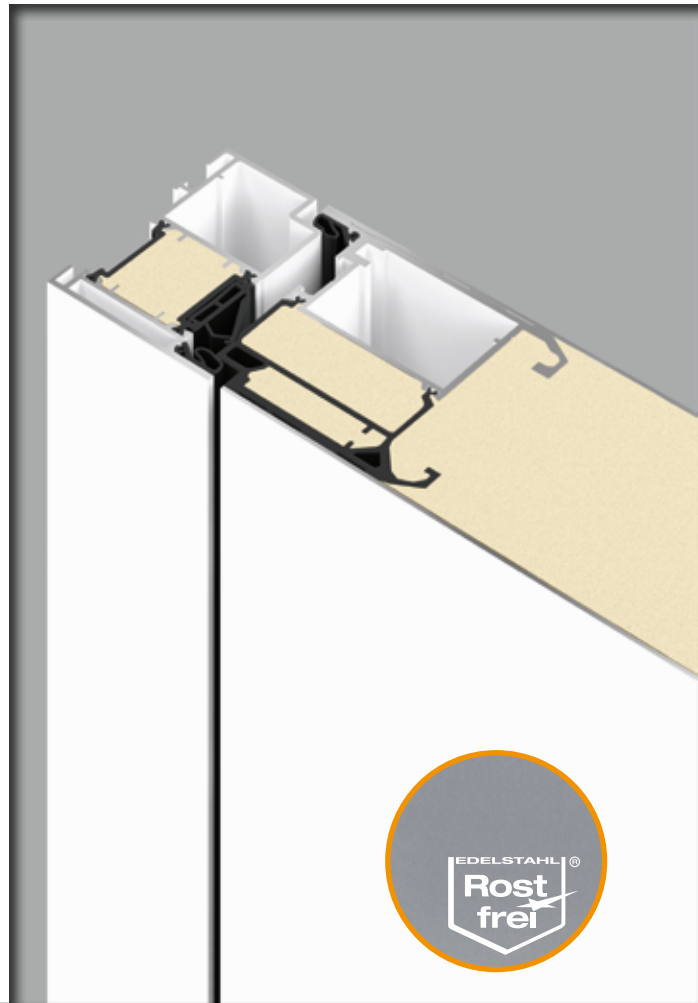
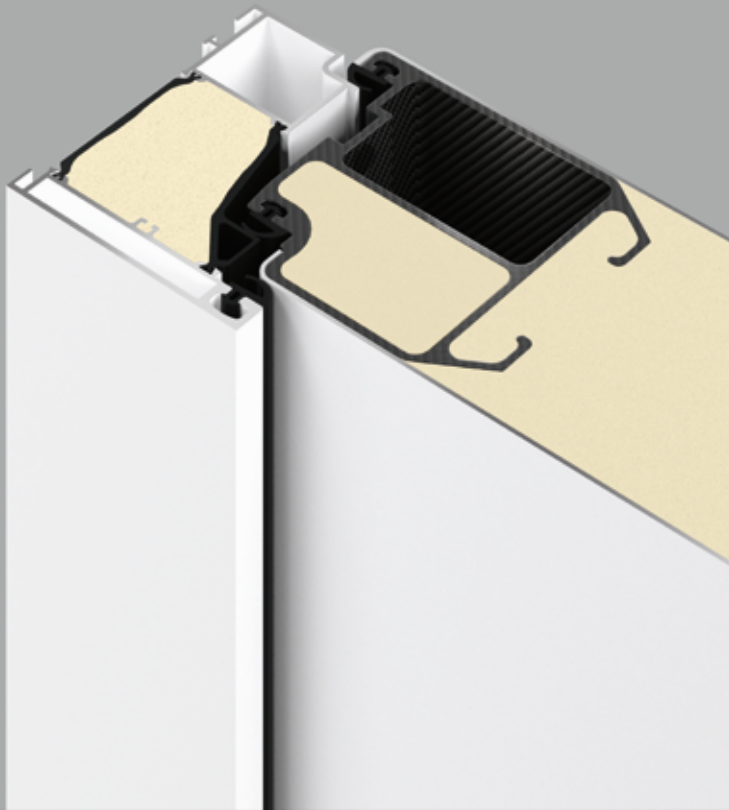

6 Excellent thermal insulation

ThermoCarbon aluminium entrance doors with a U_D -value of up to approx. $0.47 \text{ W}/(\text{m}^2 \cdot \text{K})^*$

Our doors are the new generation of high-insulation entrance doors. With U_D -values up to approx. $0.78 \text{ W}/(\text{m}^2 \cdot \text{K})$, ThermoPlan Hybrid doors have excellent thermal insulation values. ThermoSafe Hybrid and ThermoSafe entrance doors are also distinguished by their U_D -values of up to approx. $0.87 \text{ W}/(\text{m}^2 \cdot \text{K})$. All door systems comply with all the requirements of the energy saving regulation. **Our ThermoCarbon entrance doors are clearly the world champions when it comes to thermal insulation: They feature unparalleled U_D -values up to $0.47 \text{ W}/(\text{m}^2 \cdot \text{K})$ and are also certified for low-energy houses by the ift Rosenheim.**

7 Flush transition

With the aluminium and stainless steel materials used on the ThermoPlan Hybrid entrance doors, you can enjoy an elegant, flush door view. **You will not be able to see and feel any offset on the inside and outside between the door leaf and door frame.** Due to the stainless steel sheet on the outside, particularly high leaf rigidity is guaranteed.



8 Safe glazing



8 mm laminated safety glass on the interior and exterior as standard

When it comes to **industrial safety and burglar protection**, Hörmann entrance doors fulfil the absolute highest demands. The laminated safety glass on the interior and exterior of the triple-pane insulated glazing provides **maximum security**. In case of glass breakage, the glass splinters are also bound on the inside, **virtually eliminating any danger of being injured by the shards**. Furthermore, the laminated safety glass offers better protection against burglars as it makes reaching through more difficult.

9 Barrier-free entrances

The Hörmann **Ecturn opening aid** makes **it easier for you to open** your ThermoSafe, ThermoSafe Hybrid, ThermoPlan Hybrid and ThermoCarbon entrance door. Due to low energy operation, the opening aid requires no safety devices. **Door operator HDO 200 opens and closes your TopComfort entrance door fully automatically**. For your security, the Flatscan sensor monitors the inside and outside of the door. Both systems can be conveniently operated with Hörmann BiSecur hand transmitters or radio buttons. For further information, see page 93.

We protect you from unwanted visitors

An apartment is broken into every three minutes, making it even more important to equip your entrance door with a high security standard. If a burglar is not successful within approx. 90 seconds, they generally give up their break-in attempt. For this reason, nearly half of all break-in attempts fail if the entrance door is break-in-resistant. The carefully tested burglar protection is also recommended by police information centres. Further information can be found at: www.k-einbruch.de



10 Security equipment as standard

Our entrance doors make it especially difficult for burglars to break into your home. This protects your home from break-in attempts. Additionally, the security features are not visible on the door, unlike with many competitor solutions. That's brand quality from Hörmann!



Security equipment	RC 4	RC 3	RC 2
ThermoSafe		●	
ThermoSafe Hybrid	●*	●**	
ThermoPlan Hybrid		●	
ThermoCarbon	○	●	
TopComfort		○	○
Side element / transom light		○	○

● = As standard ○ = Optional
 * Door styles without glazing
 ** Door styles with glazing



11 Security promise

In the unlikely event of a break-in through a ThermoSafe, ThermoSafe Hybrid, ThermoPlan Hybrid or ThermoCarbon entrance door with RC 3 or RC 4 security equipment, Hörmann can provide

a new Hörmann entrance door with the same equipment, including specialist fitting by a Hörmann partner

or

£3000 in cash (e.g. if the damage is covered by your household insurance)

 You can find further information and a video on the topic at www.hoermann.de/

 **sicherheitsversprechen**



The experienced burglar attempts to break open the locked door with simple tools, e.g. a crowbar, as well as simple striking tools within 10 minutes.



The burglar attempts to break open the locked door with simple tools, e.g. a crowbar, as well as simple drilling tools within 5 minutes.



The opportunist burglar attempts to break open the locked door with simple tools within 3 minutes.

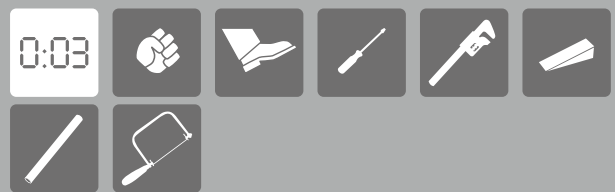



The perfect balance between comfort and security

Our ThermoSafe and ThermoSafe Hybrid entrance doors will convince you with their security and thermal insulation. Thanks to a U_D -value of up to $0.87 \text{ W}/(\text{m}^2 \cdot \text{K})$, the doors keep the cold out and the standard security equipment gives you a feeling of safety when you go to bed at night. The aluminium stainless steel entrance door ThermoSafe Hybrid impresses with its high dimensional stability and leaf rigidity, even with large temperature fluctuations inside and outside.

More than 70 door styles, 19 preferred colours, optional handle variants, glazings and operators are available to choose. The result: your individual dream door!



Construction

- 1 Solid 73 mm aluminium door leaf with PU rigid foam infill and internal leaf profile
- 2 Aluminium leaf profile with thermal break
- 3 82 mm aluminium door frame with thermal break
- 4 Triple sealing with an all-round seal

Fulfils all requirements of the energy saving regulation

Suitable for fitting without thermal bridges

Thermal insulation:

U_D -value of up to approx. $0.87 \text{ W}/(\text{m}^2 \cdot \text{K})^*$

Acoustic insulation: $R_{w,p}$ up to 34 dB (ThermoSafe), 36 dB (ThermoSafe Hybrid)

The complete performance characteristics can be found on page 94.

ThermoSafe



As standard for ThermoSafe

RC 3 security equipment as standard**

ThermoSafe Hybrid



- 5 Particularly high leaf rigidity and added security due to exterior stainless steel sheet

RC 4 security equipment** as standard and H5 security lock (styles without glazing)

RC 3 security equipment as standard** (styles with glazing)



As standard for doors without glazing



As standard for doors with glazing

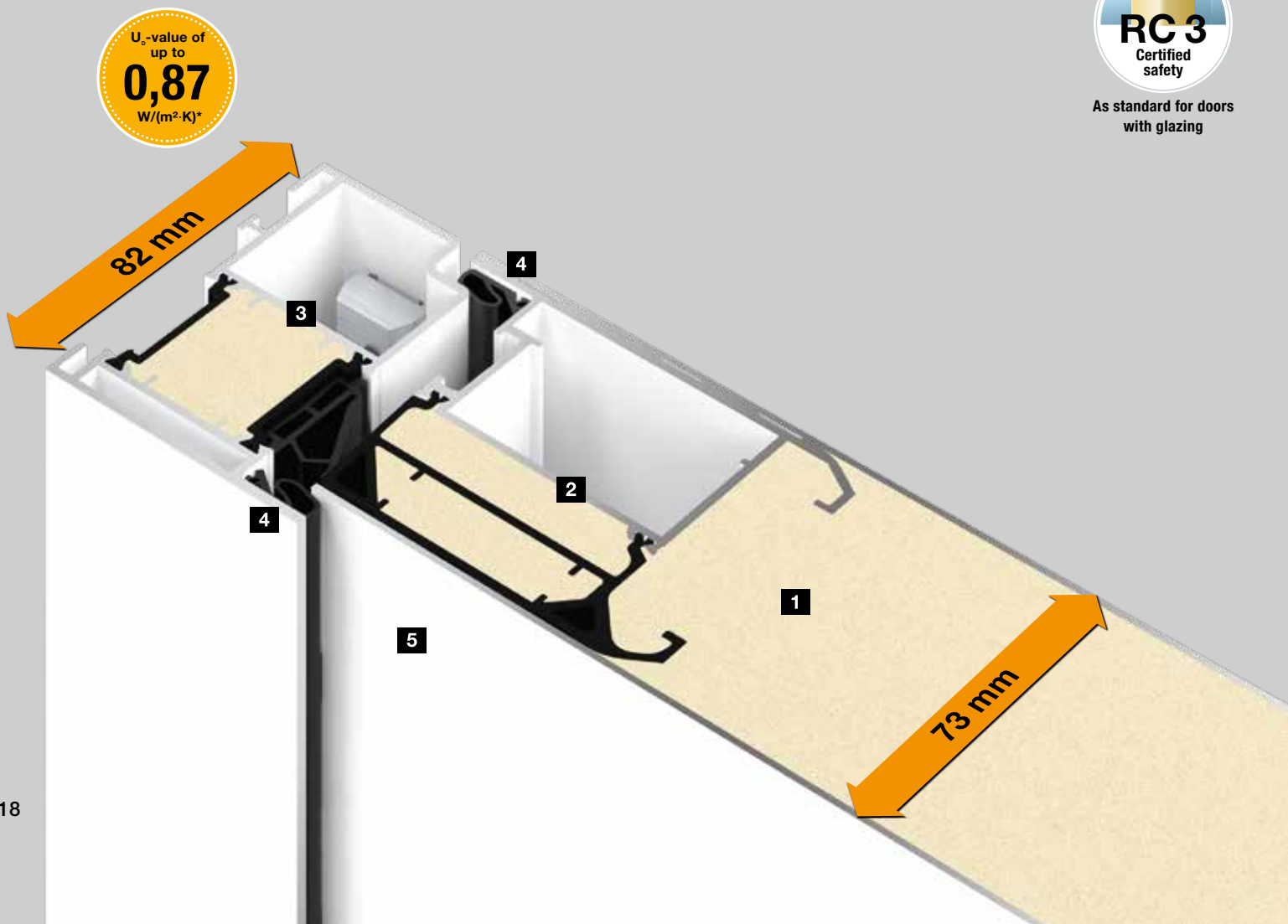

Equipment

- 6 Solid door view from the inside, as standard in Traffic white RAL 9016, matt, like on residential internal doors
- 7 Flush-fitting transition from the door leaf to the door frame on the inside
- 8 3-way adjustable hinges
- 9 Aluminium interior lever
- 10 Triple-pane thermal insulation glazing with safety glass on both sides
- 11 Profile cylinder protected against manipulation
- 12 With 5-point security lock
- 13 Security bolts

Colour

- As standard in Traffic white, RAL 9016, matt
- Optionally in 19 preferred colours
- Optionally in RAL to choose

For further information, see page 84.

Interior view



* Dependent on door size. Specified values for RAM 1230 x 2180 mm

** Break-in-resistant components are only effective in preventing burglaries when closed and locked, with the key removed.





Style 75

Standard colour Traffic white RAL 9016, matt, stainless steel handle 38-1, Master-Carré ornamental glass



Style 65

Preferred colour Hörmann CH 607 Chestnut, fine structure, matt, stainless steel handle HOE 600, matt float design glass with 7 clear stripes



Style 185

Standard colour Traffic white RAL 9016, matt, stainless steel handle 38-2, Master-Carré white ornamental glass



Style 45

Preferred colour Hörmann CH 703 Anthracite, fine structure, matt, stainless steel handle HOE 200, matt Parsol grey design glass with 4 clear stripes

◀ **ThermoSafe style 75**

in standard colour Traffic white RAL 9016, matt, with side element

An invitation to feel at home

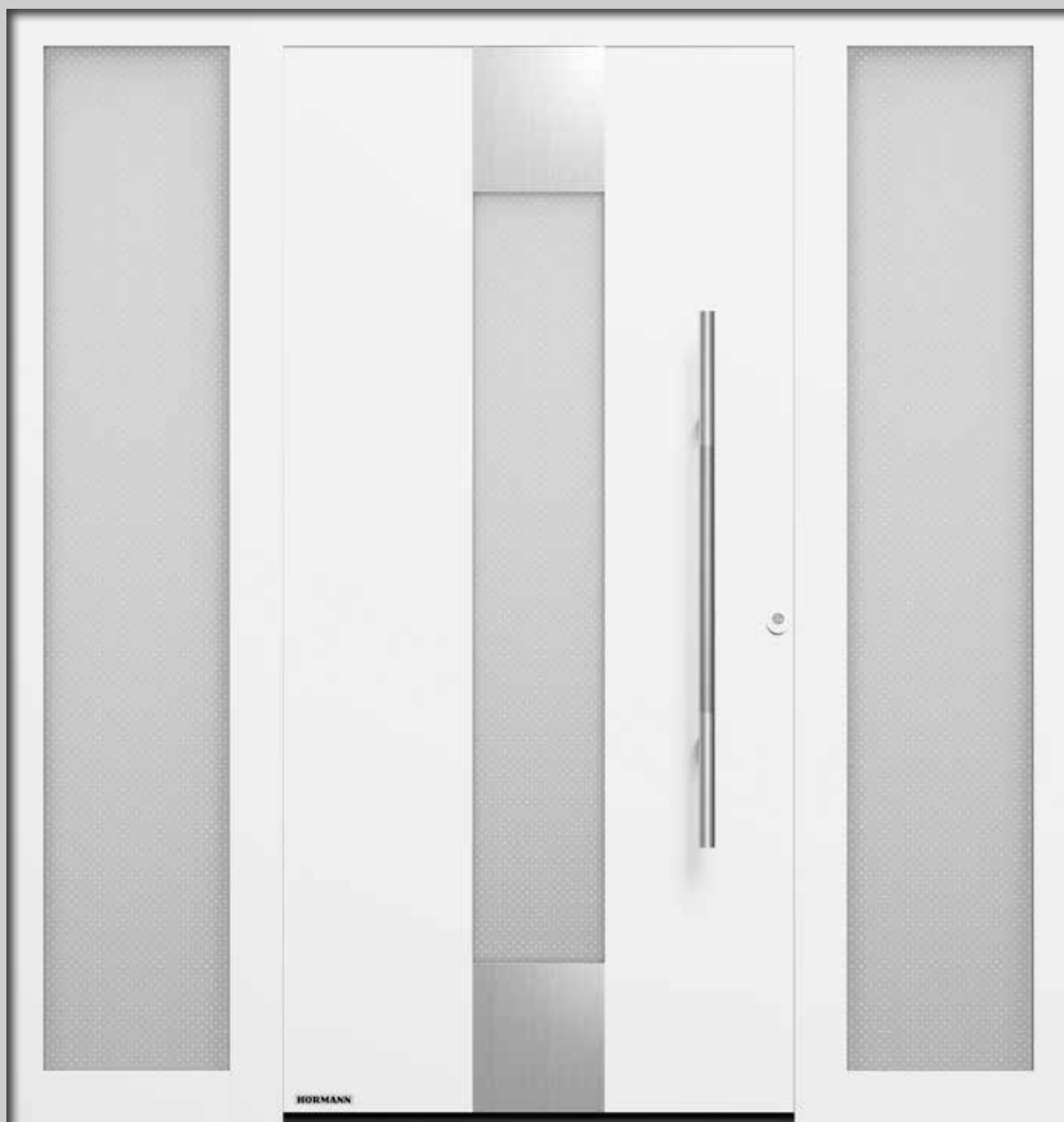

Style 680

Standard colour Traffic white RAL 9016, matt, stainless steel handle HOE 700,
Pave white ornamental glass



Style 110

Preferred colour Stone grey RAL 7030, matt, stainless steel handle 38-1, optional Cathedral white ornamental glass



Style 138 ■ NEW

Standard colour Traffic white RAL 9016, matt, stainless steel handle HOE 500, Satinato ornamental glass



Style 650

Preferred colour Window grey RAL 7040, matt, stainless steel handle HOE 700, Pave white ornamental glass



Style 140

Preferred colour Slate grey RAL 7015, matt, stainless steel handle 38-1, stainless steel embellishment, Pave white ornamental glass





Style 501

Preferred colour Quartz grey RAL 7039, fine structure matt, stainless steel handle HOE 500, Satinato glazing

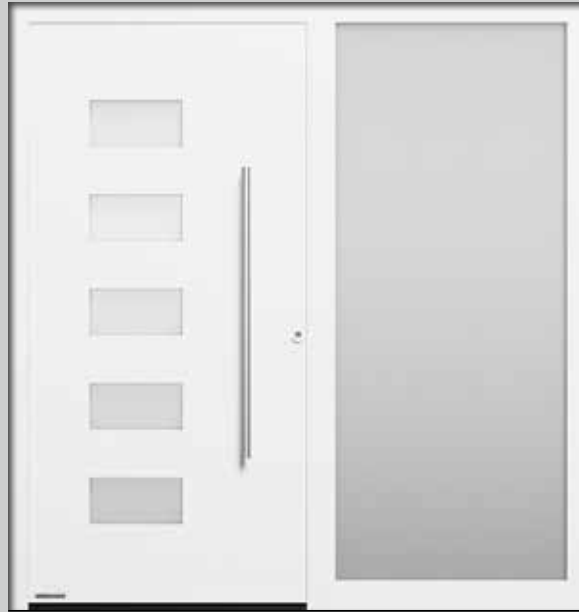

Style 502

Standard colour Traffic white RAL 9016, matt, stainless steel handle HOE 500, Satinato glazing



Style 505

Standard colour Traffic white RAL 9016, matt, stainless steel handle HOE 500, matt float design glass with 4 clear stripes



Style 504

Preferred colour Slate grey RAL 7015, fine structure matt, stainless steel handle HOE 500, matt float design glass with 7 clear stripes

◀ **ThermoSafe style 504**

in preferred colour Grey aluminium RAL 9007, fine structure matt



Style 686

Preferred colour Ruby red RAL 3003, matt, stainless steel handle HOE 600, stainless steel embellishment, matt float design glass with 7 clear stripes



Style 860

Standard colour Traffic white RAL 9016, matt, stainless steel handle HOE 700

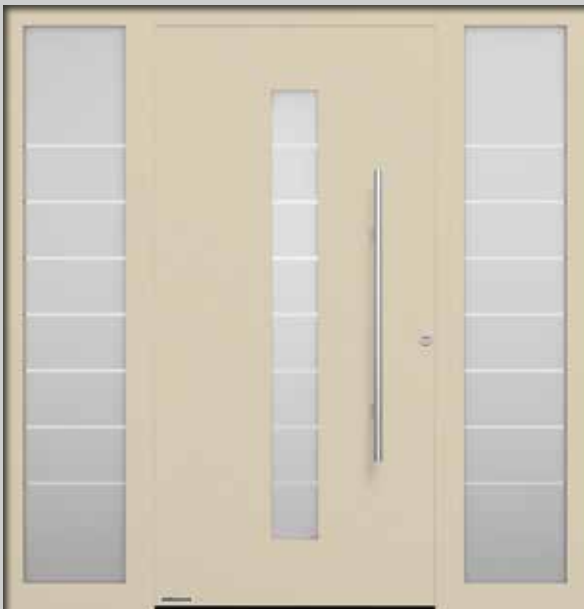

Style 503

Preferred colour Cream RAL 9001, fine structure matt, stainless steel handle HOE 500, matt float design glass with 7 clear stripes



Style 189

Standard colour Traffic white RAL 9016, matt, stainless steel handle HOE 615, matt float design glass with 7 clear stripes



Style 867

Standard colour Traffic white RAL 9016, matt, stainless steel handle HOE 620, matt float design glass with 7 clear stripes



Style 871

Preferred colour Slate grey RAL 7015, fine structure matt, stainless steel handle HOE 620, side elements with matt float design glass with 3 clear stripes



Style 862

Preferred colour Quartz grey RAL 7039, fine structure matt, stainless steel handle HOE 620



Style 872

Standard colour Traffic white RAL 9016, matt, stainless steel handle HOE 615, side elements with matt float design glass with 6 clear stripes



Impressive extras for design enthusiasts: LED spotlights



Style 723

Preferred colour Grey aluminium RAL 9007, fine structure matt, with optional LED spotlight in handle, handle profile in White aluminium RAL 9006, fixing profiles in door colour, ornamental glass Satinato



Style 823

Preferred colour Grey aluminium RAL 9007, fine structure matt, with optional LED spotlight in handle, handle profile in White aluminium RAL 9006, fixing profiles in door colour, optional fascia frame Caro



Style 565

Preferred colour Stone grey RAL 7030, fine structure matt, with handle embellishment in Decograin Golden Oak, side elements with ornamental glass matt float



Style 832

Standard colour Traffic white RAL 9016, matt, stainless steel handle HOE 820, embellishment in Slate grey RAL 7015, with horizontal and vertical stainless steel pilaster strips



Style 568

Preferred colour Hörmann CH 703 Anthracite, fine structure matt, side elements with matt float ornamental glass, design handle G 750, optionally also with light strip integrated in the handle



Style 836

Standard colour Traffic white RAL 9016, matt, stainless steel handle HOE 820, flush-fitting embellishment in Slate grey RAL 7015





Style 693

White aluminium, RAL 9006, silk-gloss,
stainless steel handle HOE 300



Style 891*

Preferred colour Quartz grey
RAL 7039, fine structure matt,
security handle set 62-1



Style 689

Standard colour Traffic white RAL 9016, matt,
stainless steel handle 38-2, matt Parsol grey
design glass with 7 clear stripes



Style 861

Standard colour Traffic white
RAL 9016, matt,
stainless steel handle HOE 700





Style 514

Standard colour Traffic white RAL 9016, matt, design handle G 750 in White aluminium RAL 9006, silk-gloss, clear float glazing



Style 524

Preferred colour Anthracite grey RAL 7016, fine structure matt, design handle G 750 in White aluminium RAL 9006, silk-gloss, clear float glazing



Style 877

Standard colour Traffic white RAL 9016, matt, stainless steel handle HOE 610, matt float design glass with 3 clear stripes



Style 879

Standard colour Traffic white RAL 9016, matt, design handle G 750 in anodised aluminium E6 / EV 1, matt float design glass with 3 clear stripes



Style 759

Standard colour Traffic white
RAL 9016, matt, design handle
G 750 in anodised aluminium
E6 / EV 1, matt float design glass
with clear stripes



Style 757

Preferred colour Grey aluminium RAL 9007,
fine structure matt, stainless steel handle HOE 797,
matt float design glass with clear stripes



Style 777

Standard colour Traffic white
RAL 9016, matt, stainless steel
handle HOE 610, matt float
ornamental glass



Style 779

Preferred colour Stone grey RAL 7030, fine structure
matt, design handle G 750 in anodised aluminium
E6 / EV 1, matt float ornamental glass, side elements
with matt float ornamental glass with 5 clear stripes





Style 176

Preferred colour White aluminium, RAL 9006, silk-gloss, stainless steel handle HOE 735, Satinato ornamental glass



Style 177

Standard colour Traffic white RAL 9016, matt, stainless steel handle HOE 700, Pave white ornamental glass

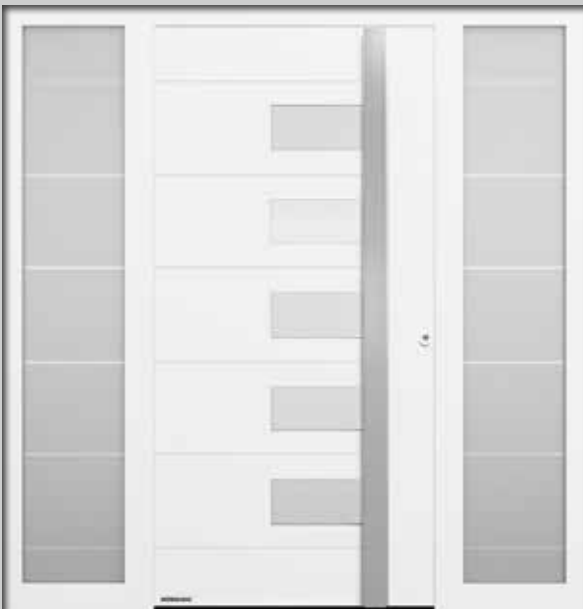

Style 799

Standard colour Traffic white RAL 9016, matt, design handle G 750 in anodised aluminium E6 / EV 1, matt float ornamental glass, side elements with matt float design glass with 6 clear stripes



Style 797

Preferred colour Anthracite grey RAL 7016, fine structure matt, stainless steel handle HOE 797, matt float ornamental glass



Style 136
Standard colour Traffic white RAL 9016, matt, stainless steel handle 38-1, Satinato design glass with 7 matt stripes

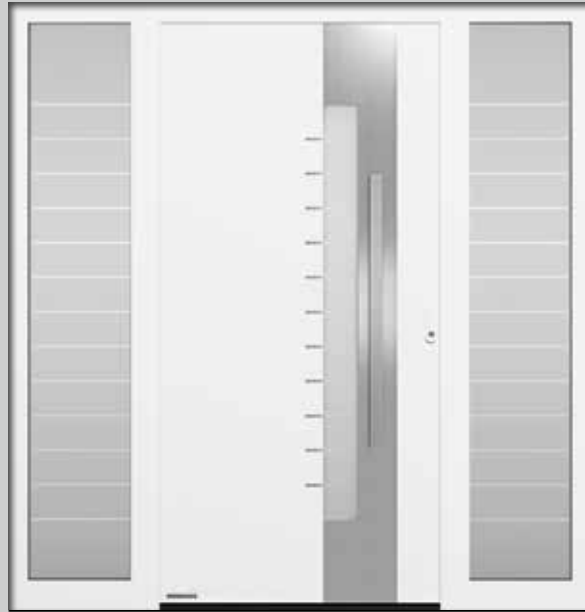

Style 560
Standard colour Traffic white RAL 9016, matt, stainless steel handle HOE 600, matt design glass with 11 clear stripes



Style 166
Preferred colour Hörmann CH 703 Anthracite, fine structure, matt, stainless steel handle 38-1, stainless steel embellishment, Satinato design glass with 7 matt stripes



Style 697
Preferred colour Hörmann CH 703 Anthracite, fine structure, matt, with Rondo 70 fascia frame, stainless steel handle HOE 910, matt Parsol grey design glass with 7 clear stripes



Style 40

Preferred colour Stone grey RAL 7030, fine structure matt, stainless steel handle HOE 550, design glass partially matt



Style 551

Standard colour Traffic white RAL 9016, matt, hand-crafted stainless steel handle HOE 150, with fascia frame Rondo 70



Style 552

Standard colour Traffic white RAL 9016, matt, hand-crafted stainless steel handle HOE 150, matt float design glass with clear stripes and red colour stripes



Style 553*

Standard colour Traffic white RAL 9016, matt, aluminium handle G 753 in silver, matt Reflo design glass with genuine fluted glass



Style 590*

Preferred colour Slate grey RAL 7015, matt, colour embellishment in Traffic white RAL 9016, matt, design handle G 750, Reflo design glass with genuine fluted glass and sandblasted design, with fascia frame Caro 70



Style 583

Preferred colour Anthracite grey, RAL 7016, matt, colour embellishment in Black brown RAL 8022, matt, aluminium handle G 755, matt Reflo design glass with clear edge

* Not available as ThermoSafe Hybrid





Style 445

Preferred Hörmann colour CH 607 Chestnut, fine structure matt, with design side elements, optional stainless steel handle 14-2, ornamental glass Chinchilla



Style 402

Standard colour + Traffic white RAL 9016, matt, stainless steel handle 14-2, Reflo design glass, partially matt with genuine fluted glass



Style 413

Standard colour Traffic white RAL 9016, matt, stainless steel handle 14-2, Silk ornamental glass



Style 675

Standard colour Traffic white RAL 9016, matt, with Rondo 70 fascia frame, stainless steel handle 38-1, Reflo design glass with genuine fluted glass



Style 694

Preferred colour Terra brown RAL 8028, matt, stainless steel handle HOE 700, Reflo design glass with genuine fluted glass

◀ Style 445 in standard colour Traffic white RAL 9016, matt, with optional Reflo glass with fluted glass and handle 38-1



Perfectly matching entrance door and garage door

The extensive Hörmann programme with matching products provides you with aligned entrance door and garage door ribbing options for a matching appearance. The result: no offset from the base line. You will see: the beauty of your home is reflected in these small but crucial details.



Perfectly matched: entrance door styles and sectional garage doors, M- or L-ribbed



ThermoSafe entrance doors:

Style 825
Style 845
Style 855



Sectional garage doors, M-ribbed:

with a door height of 2000 mm
with a door height of 2125 mm
with a door height of 2250 mm



ThermoSafe entrance doors:

Style 875
Style 895
Style 898

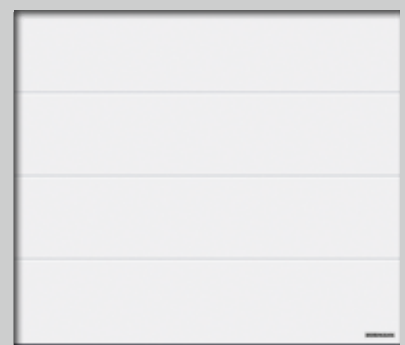

Sectional garage doors, L-ribbed:

with a door height of 2000 mm
with a door height of 2125 mm
with a door height of 2250 mm



▲ **ThermoSafe style 895** in preferred colour Anthracite grey RAL 7016, matt, with side element, L-ribbed sectional garage door in Silkgrain Anthracite grey RAL 7016

Matching entrance and garage door

The cross-section of the entrance and garage door clearly shows: The ribbed look of the entrance door is due to the grooves in the infill. With the garage door, this is created by the ribbing of the individual sections and the section transitions. The aligned appearance also applies if the entrance door has a different installation height than the garage door. We can adjust the groove heights individually according to your specifications, all we need is the height offset.



ThermoSafe entrance door cross-section



Sectional garage door cross-section

After precise measurement on site, your Hörmann specialist dealer will advise you on the ideal overall look based on these entrance door styles.



Matching entrance and garage doors*



Style 188
Preferred colour Anthracite grey RAL 7016, stainless steel handle HOE 100, matt float design glass with 3 clear stripes



Sectional garage door
L-ribbed design style 457 in Silkgrain Anthracite grey RAL 7016



Style 173
Preferred colour Ruby red RAL 3003, matt, stainless steel handle HOE 300, optional matt float ornamental glass, side elements with optional matt float design glass with 3 clear stripes



Sectional garage door
L-ribbed design style 461 in Silkgrain Ruby red RAL 3003

◀ **Style 188** in standard colour Traffic white RAL 9016, matt, with side elements, sectional garage door, L-ribbed, design style 457 in Silkgrain Traffic white RAL 9016

* The spacings between the entrance and garage door are not completely flush

High quality all-round

1 3-way adjustable hinges

With the elegant, three-way adjustable hinges, the door leaf can be simply and conveniently adjusted by the Hörmann specialist partner. This way, your entrance door is optimally sealed and falls shut smoothly and securely.

2 Optional concealed hinges*

Concealed hinges make for an elegant door appearance on the interior. The hinges feature leverage protection so that the security bolts on the hinge side can be omitted.

3 Tamper-proof profile cylinder

The profile cylinder is equipped with an anti-picking system, which prevents manipulation by objects inserted into the lock, and also has drill-proofing. In addition, it offers an emergency and hazard function, i.e. the door can still be opened and closed when a key is inserted on the inside. The tamper-proof locking cylinder is certified according to DIN 18252 / DIN EN 1303 and is delivered with 5 reversible keys and 2 key caps.

Exterior surface-mounted security rose escutcheon

The patented exterior rose escutcheon also protects the profile cylinder against being drilled open and twisted off. Delivered as standard in Traffic white RAL 9016, or in stainless steel for coloured doors.

4 Aluminium interior lever

ThermoSafe Hybrid and ThermoSafe entrance doors are equipped as standard with the attractive interior lever Rondo, stove-enamelled in white. Optionally, it is also available in stainless steel or RAL to choose as well as in versions Caro or Okto, each in stainless steel.

5 Stainless steel lock plate

The lock plate is optimally adjusted by the Hörmann specialist partner so that your door falls shut optimally and can be securely locked.

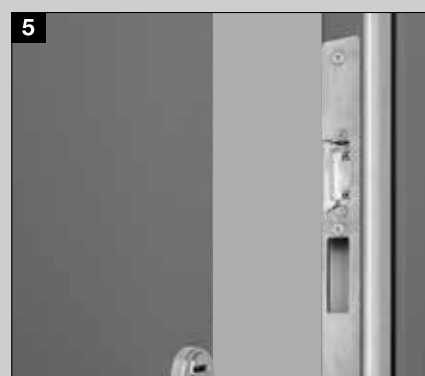

6 5-point security lock H5 and security bolts on the hinge side

When locking, 3 steel swing bolts with 2 additional bolt locks pivot into the stainless steel lock plate. The swing bolts make it more difficult for the door to be pulled apart or forced open.

7 Electronic spyhole (optional)

Your entrance area is monitored with a wide angle camera. The spyhole with 3.5" LCD monitor is ideal for small children and persons who depend on a wheelchair.

Integrated overhead door closer (optional, not shown)

The integrated overhead door closer closes the door and gives it an elegant interior view – especially in combination with concealed hinges.

Opening limiter*
(optional, not shown)

The high-quality opening limiter in the metal version restricts the door opening to an opening angle of 105°. It is individually adjustable and features the convenient soft stop function.

8 Retractable bottom seal with weather protection

Optional for all ThermoSafe and ThermoSafe Hybrid entrance doors: The retractable bottom seal is the best solution for barrier-free entrances without threshold. The sealing of the door bottom edge withstands driving rain and convinces with low air permeability.



Barrier-free entrances

Optional frame variants

9 Broader door frames

On request, door frames are also available in a width of 110 mm, for a more convenient and attractive connection and full thermal insulation, for example.

10 Fascia frame Caro 70

This version has an attractive and distinguished look that adds value to your door through the spatial depth of the frame.

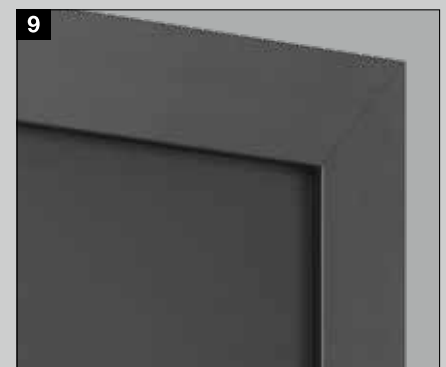

* For doors opening inwards



Elegance for your home

If you have high demands on security, thermal insulation and technical equipment, and also appreciate an exclusive look for your home, the ThermoPlan Hybrid is the right choice for you. The design of this door impresses with the flush transition between the frame and door leaf. The stainless steel sheet on the outside guarantees particularly high dimensional stability, even in case of large temperature differences.

In addition, the high-quality equipment appeals with U_D -values of up to approx. $0.78 \text{ W}/(\text{m}^2 \cdot \text{K})$ and with RC 3 equipment as standard.

The ThermoPlan Hybrid entrance door is available in 12 elegant door styles and 19 preferred colours for you to choose from. With many other equipment options such as handles, glazing and lock variants, the ThermoPlan Hybrid becomes your individual dream door.

ThermoPlan Hybrid
from €3900*

Construction

- 1** 82 mm aluminium door leaf with PU rigid foam infill and internal leaf profile
- 2** Flush-fitting transition from the door leaf to the door frame on the outside
- 3** High leaf rigidity due to painted exterior stainless steel sheet
- 4** Aluminium leaf profile with thermal break
- 5** 82 mm aluminium door frame with thermal break
- 6** Triple sealing with two all-round seals

Fulfills all requirements of the energy saving regulation and is suitable for low-energy houses

Suitable for fitting without thermal bridges

Thermal insulation: U_D -value of up to approx. $0.78 \text{ W}/(\text{m}^2\cdot\text{K})^*$

Acoustic insulation: $R_{w,p}$ up to 36 dB

The complete performance characteristics can be found on page 94.

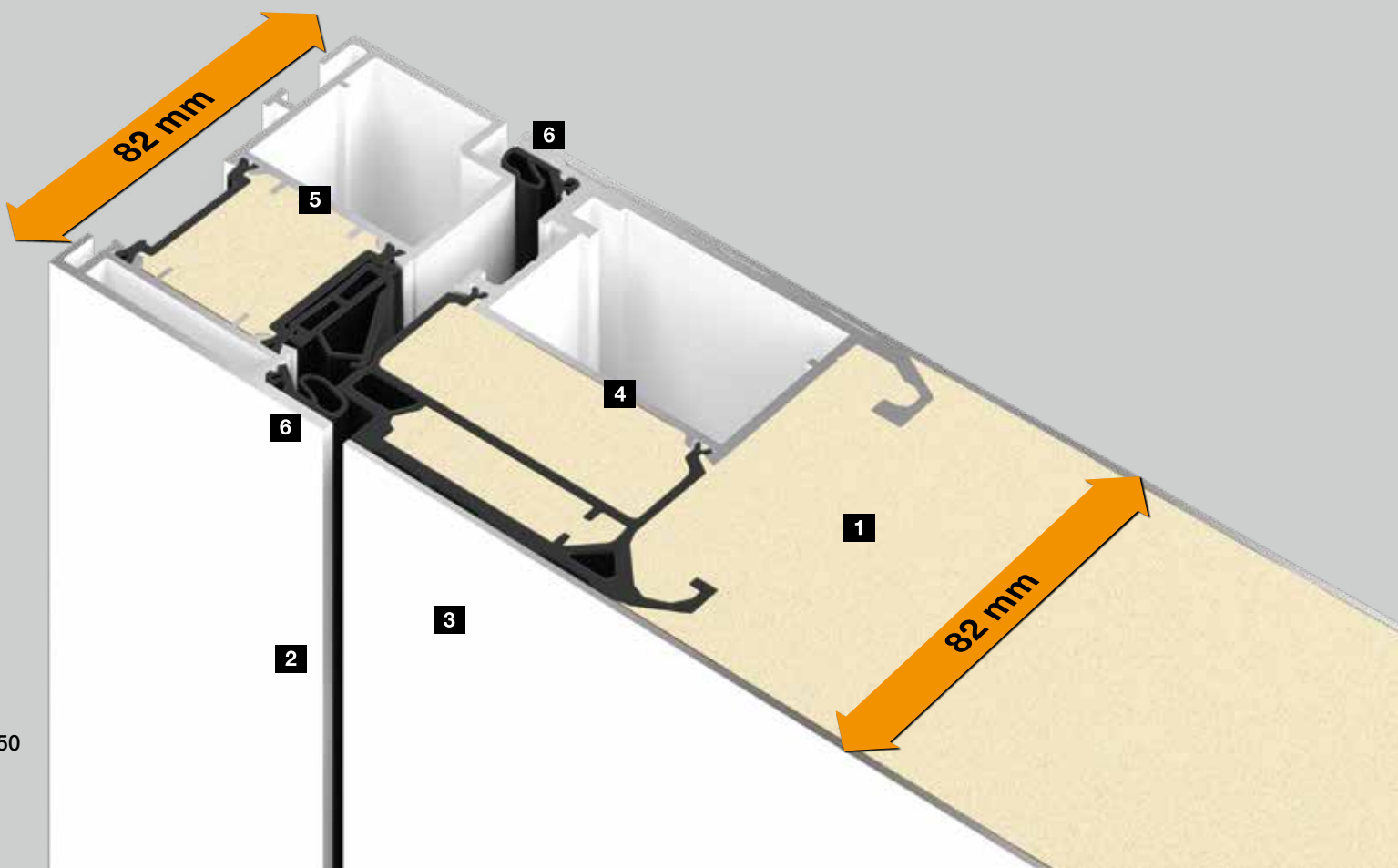
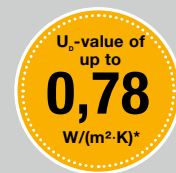

Equipment

- 6 Solid door view from the inside, as standard in Traffic white RAL 9016, matt, like on residential internal doors
 - 7 Flush-fitting transition from the door leaf to the door frame on the inside
 - 8 3-way adjustable hinges
 - 9 Aluminium lever handle
 - 10 Triple-pane thermal insulation glazing with safety glass on both sides
 - 11 Profile cylinder protected against manipulation
-
- 12 RC 3 security equipment** with 5-point security lock
-
- 13 Security bolts

Colour

- As standard in Traffic white, RAL 9016, matt
- Optionally in 19 preferred colours
- Optionally in RAL to choose

For further information, see page 84.

Interior view



* Dependent on door size. Specified values for RAM 1230 x 2180 mm

** Break-in-resistant components are only effective in preventing burglaries when closed and locked, with the key removed.





Style 860

Preferred colour Hörmann CH 703 Anthracite, fine structure matt, stainless steel handle HOE 700



Style 189

Preferred colour Light grey RAL 7035, matt, stainless steel handle HOE 615, matt float design glass with 7 clear stripes



Style 138

Standard colour Traffic white RAL 9016, matt, stainless steel handle HOE 500, Satinato ornamental glass



Style 686

Standard colour Traffic white RAL 9016, matt, stainless steel handle HOE 600, stainless steel embellishment, matt float design glass with 7 clear stripes, side elements with matt float design glass with 7 clear stripes



Style 503

Preferred colour White aluminium RAL 9006, silk-gloss, stainless steel handle HOE 500, matt float design glass with 7 clear stripes

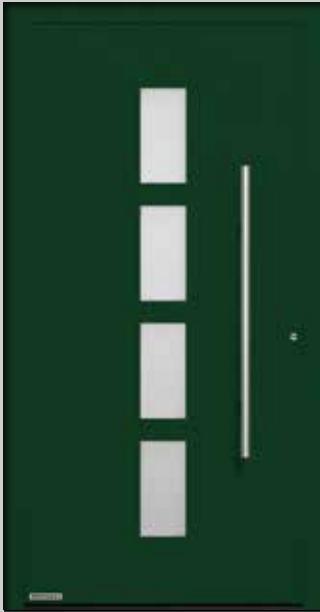

Style 501
Preferred colour Fir green RAL 6009, matt, stainless steel handle HOE 500, Satinato glazing



Style 504
Standard colour Traffic white RAL 9016, matt, stainless steel handle HOE 500, matt float design glass with 5 clear stripes, side elements with matt float design glass with 7 clear stripes



Style 502
Standard colour Traffic white RAL 9016, matt, stainless steel handle HOE 500, Satinato glazing



Style 505
Standard colour Stone grey RAL 7030, matt, stainless steel handle HOE 500, matt float design glass with 4 clear stripes, side elements with matt float design glass with 4 clear stripes

For the highest demands



Style 823 ■ NEW

Standard colour Traffic white RAL 9016, matt, handle profile in White aluminium RAL 9006, fixing profiles in door colour



Style 872

Preferred colour Anthracite grey
RAL 7016, matt, stainless steel
handle HOE 615



Style 871

Standard colour Traffic white RAL 9016, matt, stainless steel handle
HOE 620, side elements with matt float design glass with 3 clear stripes



Style 862

Standard colour Traffic white
RAL 9016, matt, stainless steel
handle HOE 620



Style 867

Preferred colour Quartz grey RAL 7039, matt, stainless steel handle
HOE 620, matt float design glass with 7 clear stripes, side elements
with matt float design glass with 7 clear stripes



High quality all-round

1 3-way adjustable hinges

With the elegant, three-way adjustable hinges, the Hörmann specialist partner can very easily succeed in optimally adjusting the ThermoPlan Hybrid entrance door. This way, your entrance door is optimally sealed and always falls smoothly and securely into its lock.

2 Optional concealed hinges

Concealed hinges make for an elegant door appearance on the interior. Thanks to hinge leverage protection, security bolts on the hinge side can be omitted.

3 Tamper-proof profile cylinder

The anti-picking system prevents manipulation by objects inserted into the lock. The profile cylinder drill-proofing gives you a sense of extra security. The emergency and hazard function is convenient: the door can still be opened and closed when the key is inserted on the inside. A tamper-proof locking cylinder certified in accordance with DIN 18252 / DIN EN 1303 is supplied including 5 reversible keys and 2 key caps.

Flush-mounted security rose escutcheon on exterior

The flush-fitting stainless steel security rose escutcheon fits into the door leaf particularly elegantly, and also protects the profile cylinder against being drilled open. Please contact your Hörmann dealer if you wish to use your own cylinder systems.

3 Aluminium interior lever

ThermoPlan Hybrid entrance doors are equipped as standard with the attractive Rondo interior lever, stove-enamelled in white. Optionally, it is also available in stainless steel or RAL to choose as well as the versions Caro or Okto, also in stainless steel.

5 Stainless steel lock plate

The lock plate is optimally adjusted by the Hörmann specialist partner so that your door falls shut optimally and can be securely locked.

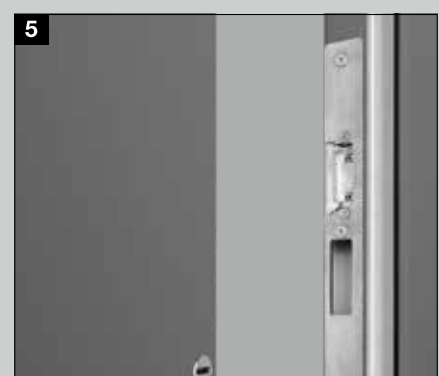

6 5-point security lock H5 and security bolts on the hinge side

When locking, 3 steel swing bolts with 2 additional bolt locks pivot into the stainless steel lock plate. The swing bolts make it more difficult for the door to be pulled apart or forced open.

7 Electronic spyhole (optional)

Your entrance area is monitored with a wide angle camera. The spyhole with 3.5" LCD monitor is ideal for small children and persons who depend on a wheelchair.

Integrated overhead door closer (optional, not shown)

The integrated, invisible overhead door closer closes the door and gives it an elegant interior view – especially in combination with concealed hinges.

Opening limiter (optional, not shown)

The high-quality opening limiter in the metal version restricts the door opening to an opening angle of 105°. It is individually adjustable and features the convenient soft stop function.





Thermal insulation world champion with high-tech equipment

Our aim was to create an entrance door that exceeds your requirements for security, thermal insulation, technical equipment and design. We have succeeded with the high-tech ThermoCarbon entrance door. With U_D -values of up to approx. $0.47 \text{ W}/(\text{m}^2 \cdot \text{K})$, the ThermoCarbon is a deserving thermal insulation world champion and, with the optional RC 4 equipment, is also a frontrunner in terms of security. With its high-tech leaf profile made of carbon glass-fibre hybrid material, our premium entrance door is exceptionally impressive, offering a high degree of rigidity and impact resistance as well as improved acoustic insulation like none other.

The ThermoCarbon entrance door is available in 20 modern door styles and 19 preferred colours, and optionally in two colours on request. Of course, you can customise your entrance door even further with many other equipment options such as handles, glazings and lock variants.

ThermoCarbon
from €4400*

Construction

- 1 100 mm aluminium door leaf with PU rigid foam infill and internal leaf profile
- 2 Thermal break and high stability thanks to carbon glass-fibre reinforced composite leaf profile
- 3 111 mm aluminium door frame with thermal break
- 4 Triple sealing with two all-round seals

Fulfils all requirements of the energy saving regulation and is certified for low-energy houses by the ift Rosenheim*

Suitable for fitting without thermal bridges

Thermal insulation: U_D -value of up to approx. $0.47 \text{ W}/(\text{m}^2 \cdot \text{K})^{}$**

Acoustic insulation: $R_{w,p}$ up to 34 dB

The complete performance characteristics can be found on page 94.



As standard



Optional

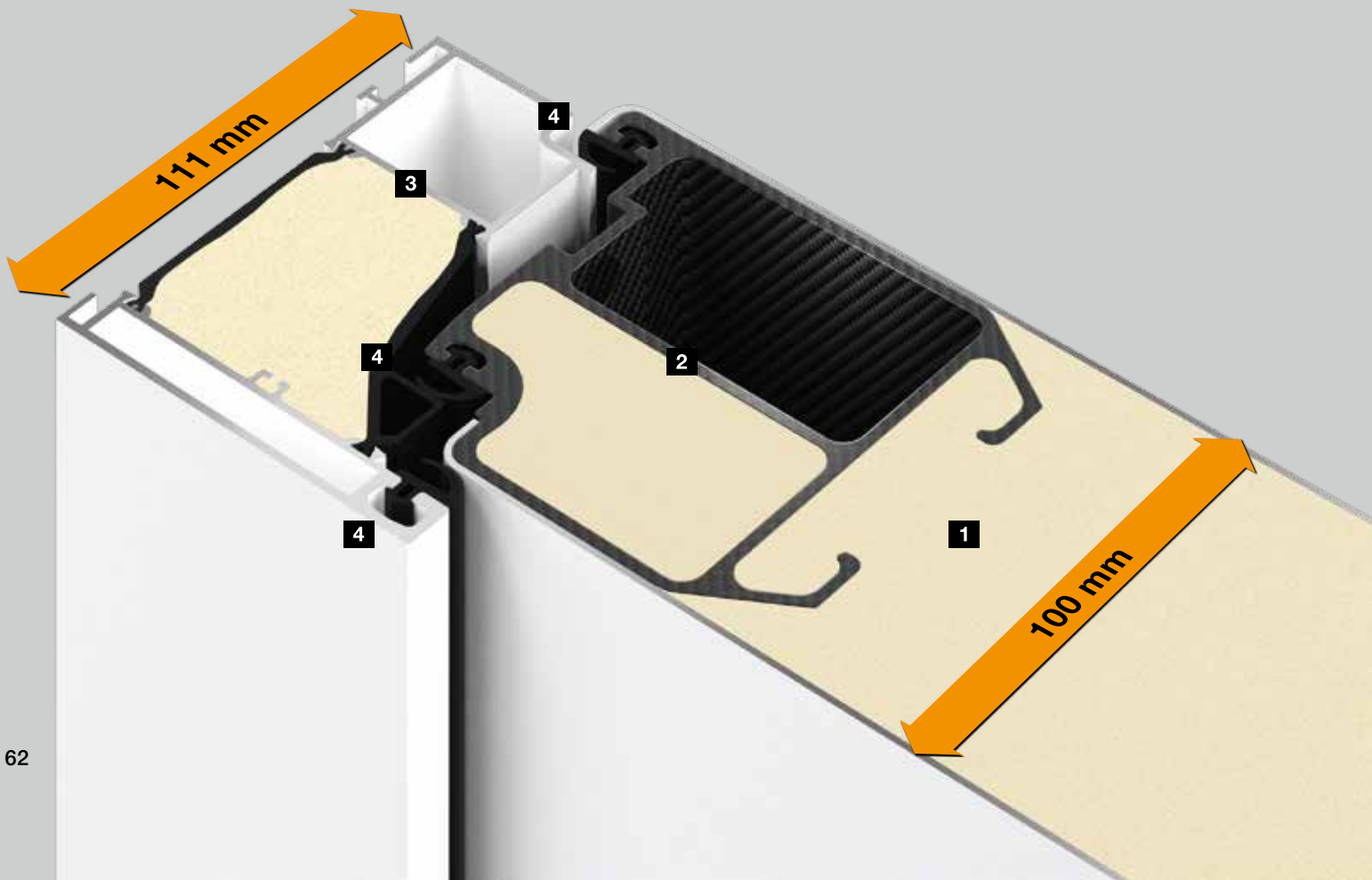
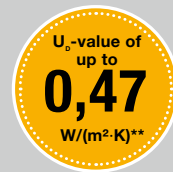

Equipment

- 5** Solid door view from the inside, as standard in Traffic white RAL 9016, matt, like on residential internal doors
 - 6** Concealed hinges incl. adjustable opening limiter with soft stop
 - 7** Stainless steel lever handle
 - 8** Quadruple-pane thermal insulation glazing with safety glass on both sides
 - 9** Profile cylinder protected against manipulation
-
- 10** RC 3 security equipment*** with 9-point security lock
-

Optional RC 4 security equipment

Colour

- As standard in Traffic white, RAL 9016, matt
- Optionally in 19 preferred colours
- Optionally in RAL to choose

For further information, see page 84.

Interior view



* Not style 310

** Dependent on door size. Specified values for RAM 1230 x 2180 mm

***Break-in-resistant components are only effective in preventing burglaries when closed and locked, with the key removed.



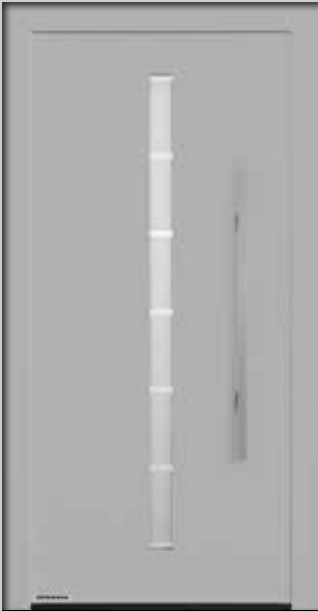

Style 189

Preferred colour
White aluminium RAL 9006,
silk-gloss, stainless steel
handle HOE 615,
matt float design glass
with 7 clear stripes



Style 504

Standard colour Traffic white
RAL 9016, matt, stainless
steel handle HOE 500,
matt float design glass
with 5 clear stripes



Style 680

Preferred colour Slate grey
RAL 7015, matt, stainless
steel handle HOE 700,
Pave white ornamental
glass



Style 862

Standard colour Traffic white
RAL 9016, matt, stainless
steel handle HOE 620



Style 650

Preferred colour Cream
RAL 9001, fine structure
matt, stainless steel handle
HOE 700, Pave white
ornamental glass



Style 686

Preferred colour Window
grey RAL 7040, matt,
stainless steel handle
HOE 610, matt float design
glass with 7 clear stripes

◀ **ThermoCarbon style 680** in preferred colour Slate grey RAL 7015, fine structure matt, with side elements



Style 565

Standard colour Traffic white RAL 9016, matt, design handle G 760 in Hörmann colour CH 703 Anthracite, fine structure matt, side elements with matt float ornamental glass



Style 568

Preferred Hörmann colour CH 607 Chestnut, fine structure matt, design handle G 750 in anodised aluminium E6 / EV 1



Style 300

Standard colour Traffic white RAL 9016, matt, handle bar in White aluminium RAL 9006, silk-gloss, side elements with matt float ornamental glass



Style 301

Preferred colour Anthracite grey RAL 7016, matt, flush-fitting aluminium embellishment and handle bar in White aluminium RAL 9006





Style 306

Standard colour Traffic white RAL 9016, matt, recessed grip in Traffic white RAL 9016, matt, flush-fitting stainless steel handle, matt float ornamental glass



Style 314

Standard colour Traffic white RAL 9016, matt, recessed grip in Traffic white RAL 9016, matt, flush-fitting stainless steel handle, matt float ornamental glass



Style 310

Preferred Hörmann colour CH 607 Chestnut, fine structure matt, flush-fitting stainless steel handle, matt float ornamental glass



Style 312

Standard colour Traffic white RAL 9016, matt, flush-fitting handle bar in White aluminium RAL 9006, silk-gloss, matt float design glass with a clear, vertical stripe



Style 302

Preferred colour Stone grey RAL 7030, matt, flush-fitting handle bar in White aluminium RAL 9006, silk-gloss, matt float design glass with a clear, vertical stripe, side elements with matt float ornamental glass

Functionality meets aesthetics



Style 823 ■ NEW

Preferred colour Anthracite grey RAL 7016, matt, optionally with LED spotlight in handle, handle profile in White aluminium RAL 9006, fixing profiles in door colour

Room-high door for spacious entrance portal



XXL version up to
3000 mm shown



Style 860

Preferred colour Ruby red RAL 3003, matt, optionally with stainless steel handle HOE 710, side elements with matt float ornamental glass



Style 308

Standard colour Traffic white RAL 9016, matt, handle bar and recessed grip in Anthracite grey RAL 7016, matt, side elements with matt float ornamental glass



Style 309

Preferred colour Slate grey RAL 7015, fine structure matt, flush-fitting handle bar in White aluminium RAL 9006, silk-gloss



Style 305

In Hörmann preferred colour CH 703 Anthracite, fine structure matt, aluminium embellishment in Ruby red RAL 3003, matt, flush-fitting stainless steel handle, side elements with matt float ornamental glass



Style 304

Preferred colour White aluminium RAL 9006, silk-gloss, recessed grip in White aluminium RAL 9006, silk-gloss, flush-fitting stainless steel handle

Premium down to the last detail

1 Concealed hinges

The hinges of the ThermoCarbon entrance door are concealed between the door frame and leaf, i.e. they are not visible either from inside or outside; this is an elegant solution for your home. The door leaf can be simply and easily adjusted by the Hörmann specialist partner. This way, you can close your entrance door comfortably and securely at all times.

2 Profile cylinder protected against manipulation

The tamper-proof profile cylinder, certified in accordance with DIN 18252 / DIN EN 1303, impresses with premium fittings: an anti-picking system, which prevents manipulation by objects inserted into the lock, drill-proofing and an emergency and hazard function. This means that the door lock can still be opened when a key is inserted on the inside. 5 reversible keys and 2 key caps are delivered with the door.

Flush-mounted security rose escutcheon on exterior

The flush-fitting stainless steel security rose escutcheon fits into the door leaf particularly elegantly, and also protects the profile cylinder against being drilled open. Please contact your Hörmann dealer if you wish to use your own cylinder systems.

3 Stainless steel interior lever

The elegant stainless steel interior lever Caro is used as standard for entrance doors ThermoCarbon.

4 Stainless steel lock plate

The high-quality stainless steel lock plate is elegantly integrated into the door frame and can be very easily adjusted by the Hörmann specialist partner. This allows for secure locking of the door at all times.

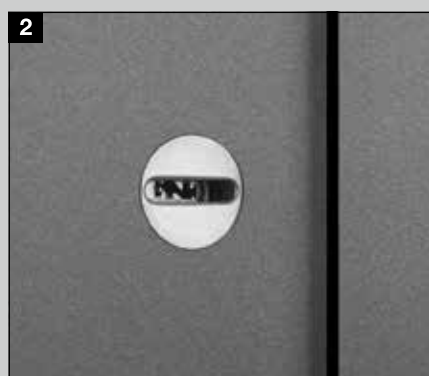

5 9-point security lock H9 and concealed hinges that cannot be forced open

The ThermoCarbon is equipped with 9-point security. When locking, 5 steel swing bolts and 4 bolt locks pivot into the stainless steel lock plate. This top quality security solution protects your door with just one turn of a key. XXL doors are supplied with the S7 automatic lock with 7-point locking as standard.

Flush-fitting exterior handles for exclusive door designs

6 Stainless steel handle with recessed grip

Doors with a stainless steel handle come with a recessed grip in the colour of the door as standard.

Individual handle colours

All flush-fitting exterior handles (except for stainless steel handles) are also available in several colour variants (see page 89 for more information).

7 Continuous aluminium handle bar

As standard, the complete handle bar is supplied in White aluminium, RAL 9006, silk-gloss, with a recessed grip in the colour of the door.

8 Aluminium handle bar with recessed grip

As standard, this handle bar comes in White aluminium, RAL 9006, silk-gloss, with a recessed grip in the colour of the door.





Glass entrance doors for well-lit entrance areas

Our TopComfort glass entrance doors create a bright and cheerful entrance area with solid equipment. The doors are characterised by an 80-mm-thick aluminium door profile and 80-mm aluminium door frame with thermal break and feature good thermal insulation with a U_D -value up to $1.3 \text{ W}/(\text{m}^2 \cdot \text{K})$. The standard 5-point security lock provides the security you expect of an entrance door. This way, you can design an entrance area that is not only tasteful, but also secure.

You can choose between 9 exclusive glass door styles that let in a maximum of natural light. We can supply the frame in one of 19 preferred colours according to your preferences. You can customise the door of your choice with stylish exterior and interior handles and glazings.

TopComfort
from €3200*



Construction

- 1 Aluminium leaf profile with thermal break, optionally with additional thermal insulation
- 2 80 mm aluminium door frame with thermal break
- 3 Double sealing
- 4 Triple thermal insulation glass with 8 mm safety glass on interior and exterior, optionally as double thermal insulation glass

Fulfils all requirements of the energy saving regulation

Suitable for fitting without thermal bridges

Thermal insulation: U_D -value of up to approx. $1.3 \text{ W}/(\text{m}^2 \cdot \text{K})^*$

Acoustic insulation: $R_{w,p}$ up to 39 dB

The complete performance characteristics can be found on page 94.

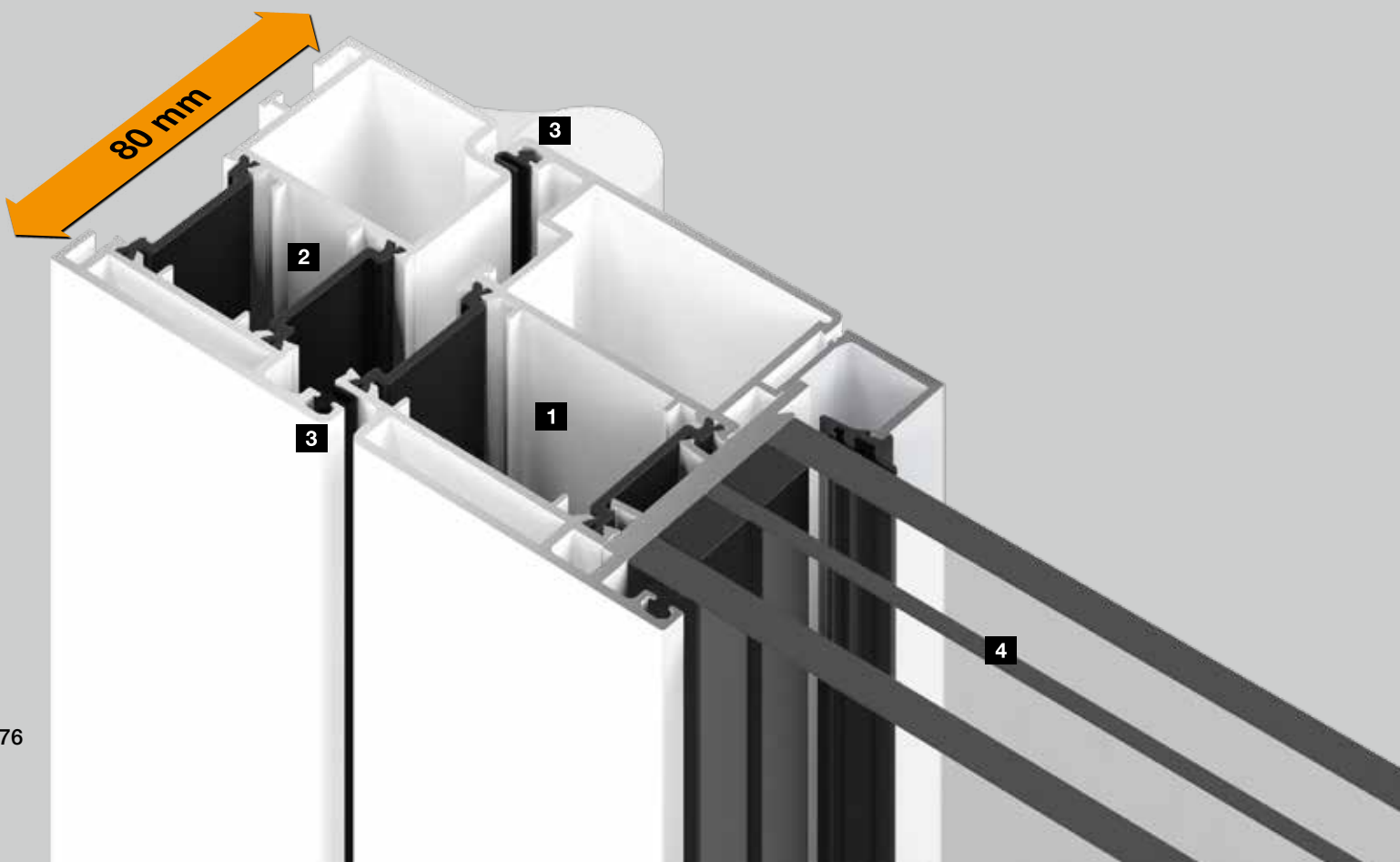
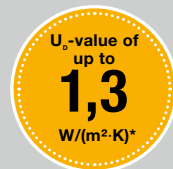

Equipment

- 5 Square glazing beads, with butt joints
- 6 3-way adjustable hinges
- 7 Aluminium interior lever
- 8 Triple thermal insulation glazing
- 9 Profile cylinder protected against manipulation
- 10 5-point security lock

Optional RC 2 / RC 3 security equipment**

Colour

- As standard in Traffic white, RAL 9016, matt
- Optionally in 19 preferred colours
- Optionally in RAL to choose

For further information, see page 84.

Interior view



* Dependent on door size. Specified values for RAM 1230 x 2180 mm

** Break-in-resistant components are only effective in preventing burglaries when closed and locked, with the key removed.



Style 100

Standard colour Traffic white RAL 9016, matt,
stainless steel handle 38-1,
Master-Carré ornamental glass



Style 101

Standard colour
Traffic white RAL 9016,
matt, stainless steel
handle 38-1, Master-Carré
ornamental glass



Style 100 MG 111

Preferred colour Hörmann CH 703 Anthracite,
fine structure, matt, stainless steel handle 38-2,
design glass with matt stripes



Style 100 MG 112

Standard colour Traffic
white RAL 9016, matt,
stainless steel handle 38-2,
Micrograin design glass
with horizontal structure

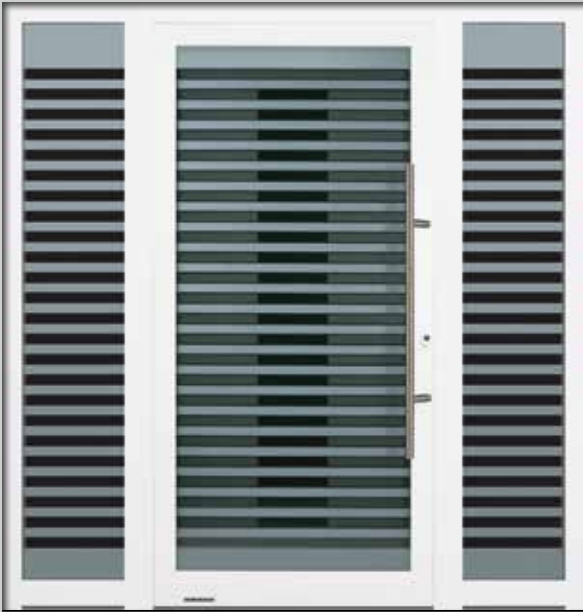

Style 100 MG 113

Traffic white RAL 9016, matt, stainless steel handle 38-2, door and side elements with design glass with 25 matt stripes



Style 100 MG 114

Preferred colour
White aluminium RAL 9006, silk-gloss, stainless steel handle 38-2, matt design glass with clear semi-circles and stripes



Style 100 MG 115

Standard colour Traffic white RAL 9016, matt, stainless steel handle 38-2, design glass matt with rectangles



Style 100 MG 116

Preferred colour Anthracite grey RAL 7016, matt, stainless steel handle 38-2, design glass with matt stripes and crescent

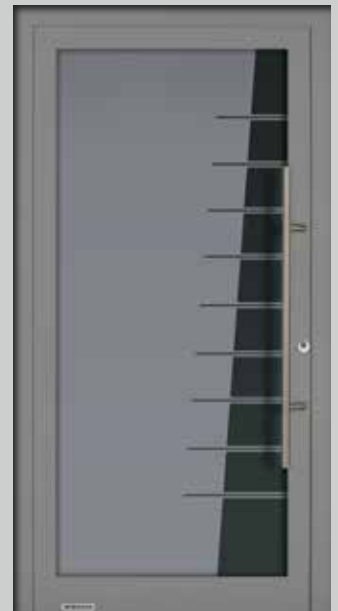

Style 100 MG 117

Preferred colour Grey aluminium RAL 9007, fine structure matt, stainless steel handle 38-2, matt design glass with 9 clear stripes



Door that make you feel at home

Our optional extras offer you a wide range of possibilities to design the door of your dreams according to your individual preferences.

For example, you can combine colours, handles and glazings based on your individual style.

We also offer you a variety of security options: You can choose between different automatic locks and convenient operating options that fulfil your needs. Whatever you decide on – at Hörmann, you will find an entrance door to suit both your taste and your home.



Designing entrances with side elements and transom lights

To create an impressive entrance to your home, you can individually combine each of the illustrated ThermoSafe, ThermoSafe Hybrid, ThermoPlan Hybrid and TopComfort entrance doors with side elements and transom lights, or combine each ThermoCarbon entrance door with side elements. For an elegant and attractive overall look that will stand the test of time.

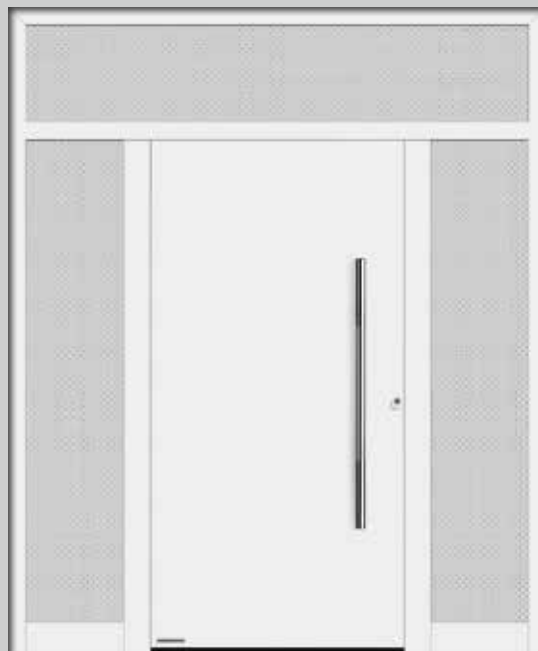

Entrance door with two side elements and transom light



Entrance door with one side element



Entrance door with one side element, style infill in the side element



Entrance door with transom light

The illustrations show ThermoSafe entrance doors with side elements and transom lights in vertical / horizontal profile construction

Side elements with practical letter box systems

Hörmann can provide you with the letter box system based on your needs and the number of flats. Letter box systems and letter drops are available with bell buttons, light switches and intercom mesh, all with high-grade stainless steel fascia and insulated aluminium panel infill plate for simple fitting without extensive brickworks.

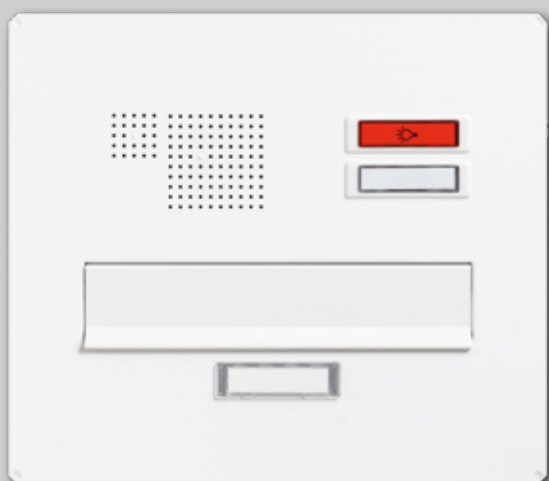

Letter box system Leabox for 1 flat ■ NEW



Letter box system RSA 2, insulated, for 5 flats

Door version	ThermoSafe Hybrid / ThermoSafe	ThermoPlan Hybrid	ThermoCarbon	TopComfort
Side elements	●	●	●	●
Side elements with style infills		●		
Transom lights	●	●		●
Letter box systems	●	●		●

Find your favourite colour

At Hörmann, we value individuality and variety. That's why we offer entrance doors in the colour of your choice as a matter of course. For example, you can select your favourite colour from the particularly inexpensive Traffic white RAL 9016 and additional preferred colours. Your Hörmann dealer will be happy to assist you.



Standard and preferred colours

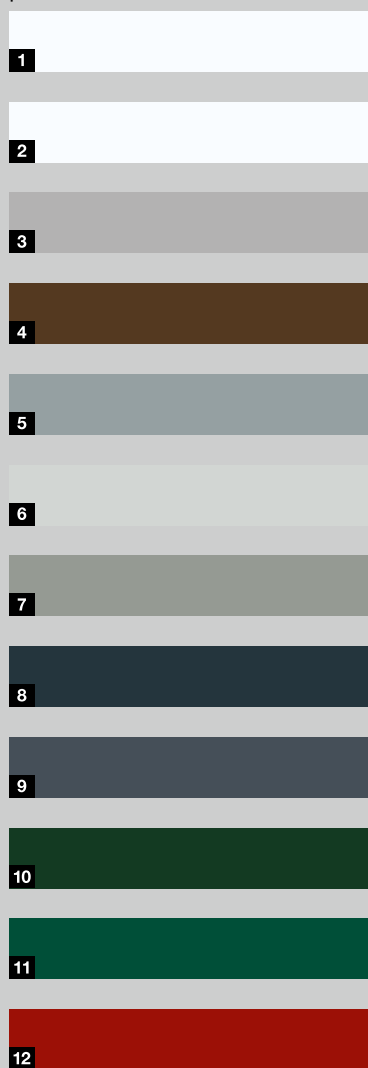

- 1 RAL 9016 Traffic white (standard)
- 2 RAL 9016 Traffic white (high-gloss)
- 3 RAL 9006 White aluminium (silk-gloss)
- 4 RAL 8028 Terra brown
- 5 RAL 7040 Window grey
- 6 RAL 7035 Light grey
- 7 RAL 7030 Stone grey
- 8 RAL 7016 Anthracite grey
- 9 RAL 7015 Slate grey
- 10 RAL 6009 Fir green
- 11 RAL 6005 Moss green
- 12 RAL 3003 Ruby red

Textured colours



- 1 RAL 9007 Grey aluminium, fine structure matt
- 2 RAL 9001 Cream, fine structure matt
- 3 RAL 7039 Quartz grey, fine structure matt
- 4 RAL 7030 Stone grey, fine structure matt
- 5 RAL 7016 Anthracite grey, fine structure matt
- 6 RAL 7015 Slate grey, fine structure matt
- 7 Hörmann colour CH 703 Anthracite, fine structure matt
- 8 Hörmann colour CH 607 Chestnut, fine structure matt

Please note:

All colours are based on RAL. All colours for ThermoSafe, ThermoSafe Hybrid, ThermoPlan Hybrid, ThermoCarbon and TopComfort are supplied with a matt powder-coating (except RAL 9006, silk-gloss and RAL 9016, high-gloss). Dark colours should not be used for doors that are exposed to the sun.

The colours and surfaces shown are subject to the limitations of the printing process and cannot be regarded as binding. Please consult with your local Hörmann specialised dealer.

Custom glazings for side elements and transom lights

Each glass type has a different look depending on colour, structure and finish. You can thus match your entrance door, side elements and transom lights according to your wishes with custom glazings or design glass.



Float, clear / clear glass



Float matt / sand-blasted



Satinato



Pave white



Parsol grey



Parsol grey, matt



Ornament 504



Ornament 553



Chinchilla



Micrograin (Madras basic)



Reflo, clear



Reflo, matt



Silk



Master-Carré



Baroque white ■ NEW



Niagara white ■ NEW



Gothic white ■ NEW



Cathedral white ■ NEW



Cast antique white ■ NEW



Uadi white ■ NEW

Tangibly beautiful design

Each Hörmann entrance door is delivered as standard with the handle shown in the product photos. However, on request, you can equip many of our doors with a customised handle.

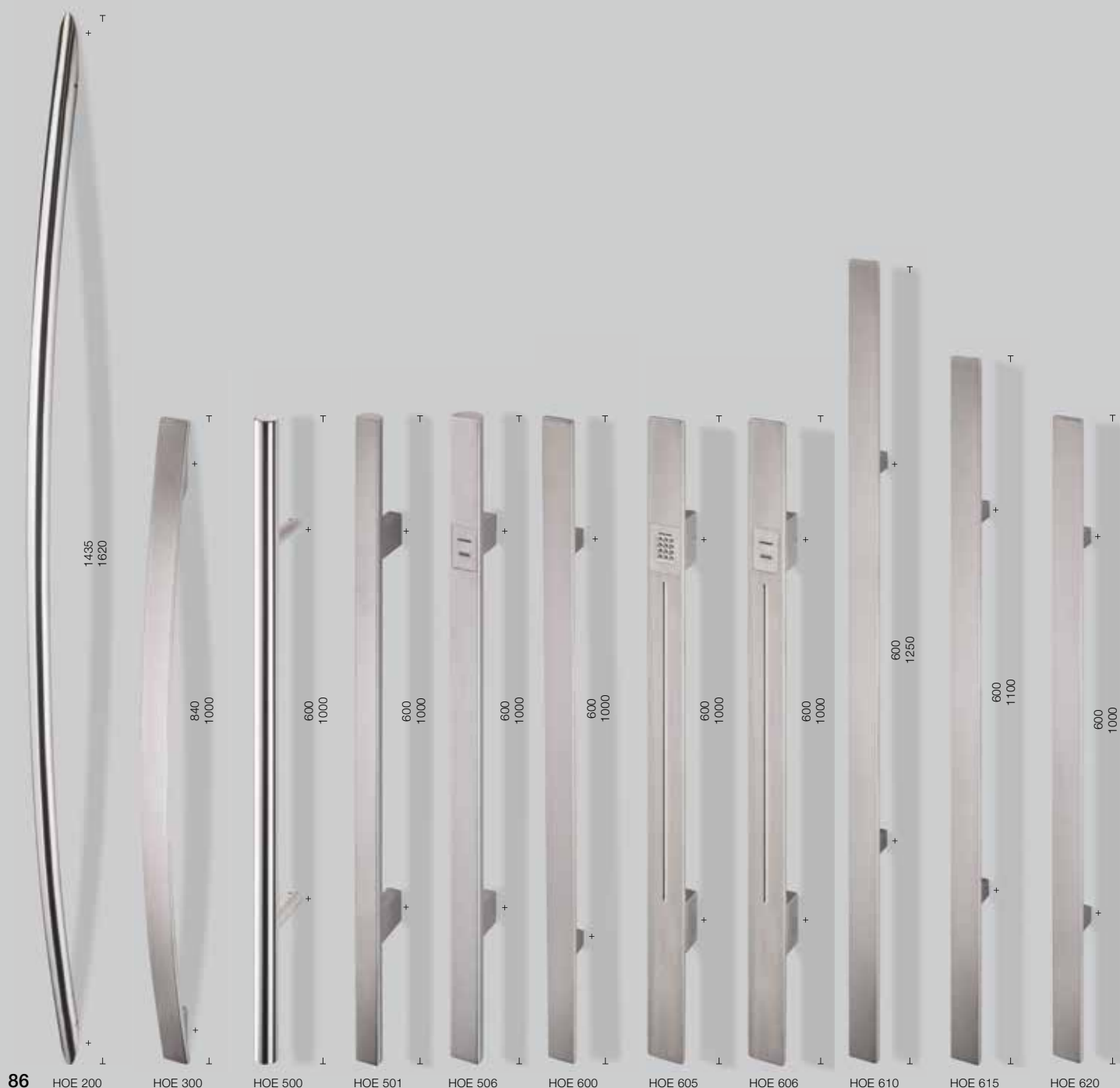



+ mm + = axis dimension
 ⊥ mm ⊥ = handle length

All details in mm

Attractive lever handles

Every Hörmann entrance door is equipped with an elegant interior lever. The different lever handle sets, lever / knob and security lever handle sets are optionally available based on design, comfort or safety according to your wishes.



Aluminium lever handle Rondo
In Traffic white, matt, RAL 9016
as standard for ThermoPlan Hybrid,
ThermoSafe Hybrid, ThermoSafe
and TopComfort



Stainless steel lever handle Caro
As standard for ThermoCarbon and
optionally for ThermoPlan Hybrid,
ThermoSafe Hybrid and
ThermoSafe



Aluminium security handle set 62-1,
optionally for ThermoPlan Hybrid, ThermoSafe Hybrid
and ThermoSafe



Stainless steel lever handle Okto
Optionally for ThermoPlan Hybrid,
ThermoSafe Hybrid and ThermoSafe



Stainless steel lever handle set
Type D-116 optionally for
ThermoPlan Hybrid, ThermoSafe
Hybrid and ThermoSafe



Stainless steel lever handle set
Type D-335, optionally for
ThermoPlan Hybrid, ThermoSafe
Hybrid and ThermoSafe

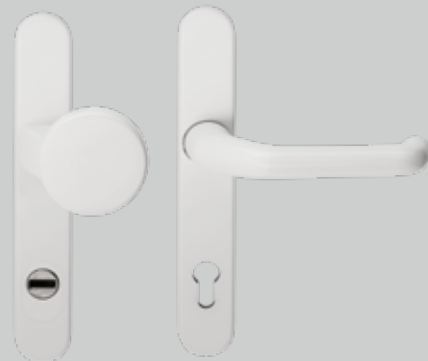

Stainless steel security handle set 62-4 in Traffic white, matt,
RAL 9016, optionally for ThermoPlan Hybrid,
ThermoSafe Hybrid and ThermoSafe

Individual colour combinations

For the exclusive ThermoCarbon entrance door styles 300, 301, 302, 304, 305, 308 and 312, you have the option to individually coordinate the flush-fitting handle bar and recessed grip with the colour of your entrance door or embellishment.



Style 300
In Traffic white RAL 9016, matt, handle bar in Traffic white RAL 9016, matt, recessed grip in door colour



Style 300
In the preferred colour Slate grey, RAL 7015, matt, handle bar in White aluminium RAL 9006, silk-gloss, recessed grip in the preferred colour White aluminium RAL 9006, silk-gloss



Style 301
In Hörmann preferred colour CH 703 Anthracite, fine structure matt, aluminium embellishment in preferred colour Ruby red RAL 3003, matt, handle bar in preferred colour Ruby red RAL 3003, matt, recessed grip in door colour

Design handle G 750



Delivered as standard in E6 / EV 1, with stainless steel end caps



No surcharge for the door surface colour, with stainless steel end caps



Optionally available in preferred colour (shown in Ruby red RAL 3003, matt) or RAL to choose deviating from door surface colour, with stainless steel end caps

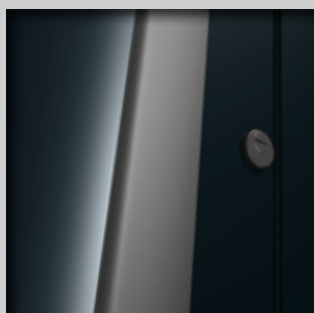

Effective illumination with LED light strip

The design handle G 750 and the DesignPlus handle G 760 are also optionally available with a light strip integrated into the handle. This particularly emphasizes your ThermoSafe or ThermoSafe Hybrid entrance door at night.

DesignPlus handle G 760

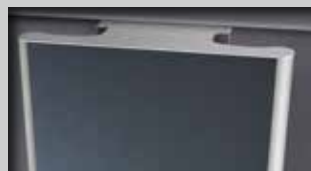

Handle bar in anodised aluminium E6 / EV 1 as standard, with stainless steel end caps (shown: handle embellishment in Hörmann colour CH 703, matt textured Anthracite)



Handle embellishment in anodised aluminium E6 / EV 1 as standard (handle bar in anodised aluminium E6 / EV 1)

Handle embellishments are also available in timber designs



Decograin Light Oak



Decograin Golden Oak



Decograin Dark Oak

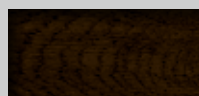

Decograin Night Oak



Decograin Rosewood

Securing excellent properties

Fingerprint, code or radio – Hörmann offers automatic lock variants for more security and convenient operation. ThermoSafe, ThermoSafe Hybrid and ThermoPlan Hybrid entrance doors are optionally available at no surcharge with the S5 automatic lock that automatically and securely locks your entrance door at four different points as soon as the door falls shut. You can also equip your **ThermoCarbon entrance door** with the 7-point S7 automatic lock at no surcharge. You may, of course, also continue to use a key to lock and unlock your door.



The elegant electro duct for concealed hinges guides the cable from the door leaf directly into the frame. This way there is no rebate air gap between the frame and leaf.

S5 / S7 automatic lock

The **bolt lock with mechanical self-locking** is available **optionally without a surcharge**. When the door falls shut, the bolts automatically extend and securely lock the entrance door. In addition, the door can also be secured via the lock with another bolt, e.g. if you are away on holiday.

Automatic lock S5 / S7 Comfort

In addition to automatic self-locking, the automatic lock S5 / S7 Comfort is also **equipped with an electric motor** that unlocks the bolts of your entrance door with an electric impulse. For this purpose, the S5 / S7 Comfort is prepared for **connection to a button on an existing home intercom**. This way, you can conveniently open your entrance door at the press of a button, for example from an upper storey. **If you want to open your entrance door conveniently from the outside**, you can choose from the lock variants Code, Scan, Smart or Bluetooth (see the following pages).

S5 / S7 Code automatic lock

Very convenient: With the automatic lock, simply entering your personal security code opens your entrance door from the outside. You can save up to 20 different codes.



Barrier-free entrances



S5 / S7 Comfort – open the door at the push of a button



S5 / S7 Code – door is opened by entering a code – fitted in the door leaf (dimensions 45 x 75 mm)



Code switch – fitted in the door handle (dimensions 45 x 75 mm)



Elegant code switch with touch-sensitive touch surface (optional for ThermoSafe and ThermoSafe Hybrid entrance doors) (dimensions 56 x 102 mm)

S5 / S7 Scan automatic lock

Open your entrance door with your fingerprint. The almost flush-fitting finger-scan* integrated into the door leaf or handle recognises up to 150 fingerprints and is VDS-approved. Furthermore, you can control another device such as the exterior lighting or your garage door operator in addition to the entrance door lock.



S5 / S7 Smart automatic lock

You can conveniently open your entrance door with an optional hand transmitter or a radio switch. The extremely secure radio system ensures that no unauthorised person can copy your radio signal. Another advantage is that you can use the same hand transmitter to operate your Hörmann garage door or entrance gate. The S5 / S7 Smart remote control can also be installed as part of the S5 / S7 Scan and S5 Code convenience packages.

Automatic lock S5 / S7 Bluetooth

Opening and closing your door via Bluetooth using your smartphone is even more convenient. Lock and unlock your entrance door using the user-friendly Hörmann **BlueSecur app**. In addition, other user permissions** can be permanently or temporarily transferred to other smartphones, so that every family member always has their “entrance door opener” with them.



S5 / S7 Scan – door is opened by fingerprint – fitted in the door leaf (dimensions 35 × 66 mm)



Finger-scan in the door handle (dimensions 35 × 66 mm)



S5 / S7 Smart – door is opened using BiSecur radio



Simple smartphone operation of the automatic lock using the Hörmann BlueSecur app

Opening aid ECTurn

ThermoCarbon, ThermoSafe Hybrid and ThermoSafe entrance doors can now be optionally equipped with the ECTurn. The opening aid is integrated elegantly into the door leaf and frame or available as a surface-mounted version. With the automatic lock and ECTurn, you can automatically open and close your door. Due to low energy operation, the opening aid requires no safety devices. The force of the ECTurn is adapted to the leaf, minimising potential hazards for persons.



Convenient opening with the ECTurn opening aid. The opening aid is also available elegantly integrated into the door leaf and frame.

Door operator HDO 200

Door operator HDO 200, optional for all aluminium entrance doors TopComfort, **in combination with a door version without threshold** incl. retractable bottom seal, is the ideal **solution for barrier-free entrances**. The inconspicuous Flatscan sensor monitors the area of travel and ensures safe operation. The operator can be conveniently operated via buttons, radar / movement detectors, etc., and optionally with BiSecur radio technology with all Hörmann hand transmitters, radio control elements, radio internal push buttons or the BiSecur app. All door parameters such as the opening or closing speed can be individually adjusted. Thanks to speed control, the operator not only operates safely in terms of opening and closing speed, but is also pleasantly quiet.



Barrier-free entrances



For barrier-free entrances in combination with a door version without threshold: the door operator HDO 200



Select your hand transmitter or radio switch from our broad accessories programme. More information can be found in the "Garage door and entrance gate operators" brochure.

Performance characteristics

Our entrance doors offer reliable functional safety and approved performance characteristics. This allows you to enjoy your Hörmann entrance door for years to come.



Performance characteristics

	ThermoSafe	ThermoSafe Hybrid	ThermoPlan Hybrid	ThermoCarbon	TopComfort
Operating forces EN 12217	Up to class 5	Up to class 5	Up to class 5	Up to class 3	Up to class 3
Long-term functionality / mechanical load EN 12400	Up to class 5	Up to class 5	Up to class 5	Up to class 6	Up to class 5
Differential climate behaviour EN 12219	Up to 2d / 2e	Up to 2d / 2e	Up to 2d / 2e	Up to 2d / 2e	Up to 2d / 2e
Air permeability EN 12207	Up to class 4	Up to class 4	Up to class 4	Up to class 4	Up to class 3
Water tightness under heavy rain EN 12208	Up to class 8A	Up to class 8A	Up to class 8A	Up to class 7A	Up to class 5A
Resistance to wind load EN 12210	Up to class C2 / B2	Up to class C2 / B2	Up to class C2 / B2	Up to class C2 / B2	Up to class C32
Impact resistance EN 13049	Up to class 2	Up to class 2	Up to class 5	Up to class 3	Up to class 3
Mechanical strength EN 1192	Up to class 3	Up to class 3	Up to class 3	Up to class 3	Up to class 1
Thermal insulation	Up to 0.87 W/(m ² ·K)	Up to 0.87 W/(m ² ·K)	Up to 0.78 W/(m ² ·K)	Up to 0.47 W/(m ² ·K)	Up to 1.3 W/(m ² ·K)
Acoustic insulation	Up to 34 dB	Up to 36 dB	Up to 36 dB	Up to 35 dB	Up to 39 dB
Burglar protection EN 1627 (optional)	RC 3	RC 3, RC 4 (optional)	RC 3	RC 3, RC 4 (optional)	RC 2, RC 3 (optional)

Note: The specified performance characteristics indicate the maximum possible performance of the entrance door. This performance may vary according to the equipment of the entrance door.

SIZES AND FITTING DATA

ThermoSafe / ThermoSafe Hybrid entrance door sizes

70 mm frame version	Overall frame dimension* (ordering size)	Structural opening*	Clear frame dimension
Standard	Max. 1250 x 2250	Max. 1270 x 2260	Max. 1110 x 2180
Oversize	Max. 1250 x 2350	Max. 1270 x 2360	Max. 1110 x 2280
XXL	Max. 1250 x 2500	Max. 1270 x 2510	Max. 1110 x 2430

ThermoSafe / ThermoSafe Hybrid side element sizes

Vertical profile construction	Side element height*	TM side element width*	TM entrance door width*
1-sided	Max. 3000	260 – 1600	Max. 1230
2-sided	Max. 3000	260 – 1600	Max. 1210

The max. transport size of a door assembly (incl. side elements, transom lights and surface-mounted profiles) must not exceed 2700 mm on any side.

Coupling construction	Side element height*	TM side element width*	TM entrance door width*
1- / 2-sided	Max. 3000	300 – 2500**	1250

* For 110 mm frames + 40 mm

** With Reflo or Micrograin glazing

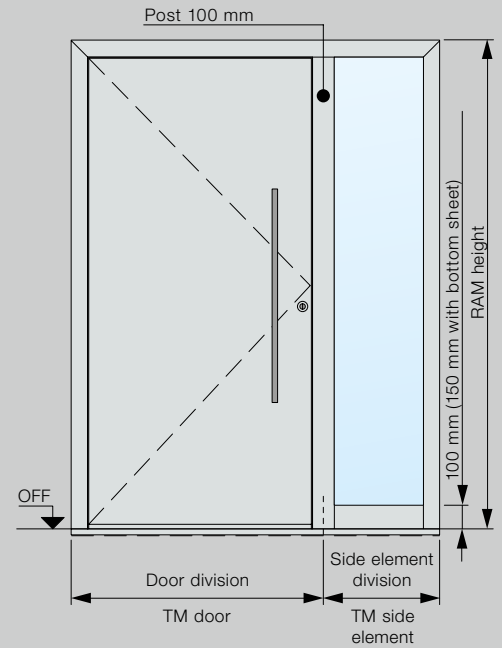

ThermoSafe / ThermoSafe Hybrid

Bottom spacer profile / transport protection

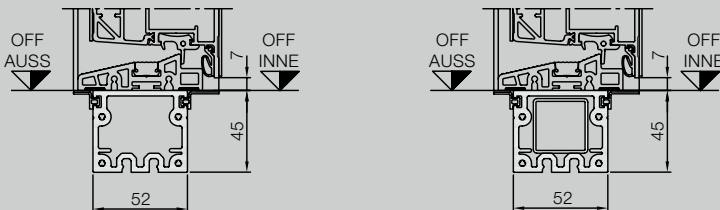

For vertical profile constructions with inserted, continuous tubular supports (shown on right).

Horizontal view of door

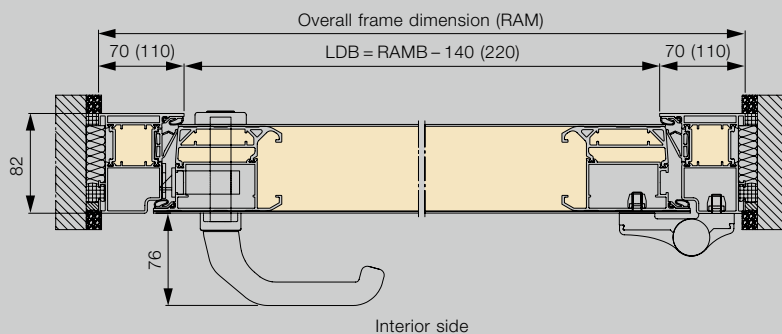

Vertical view of door

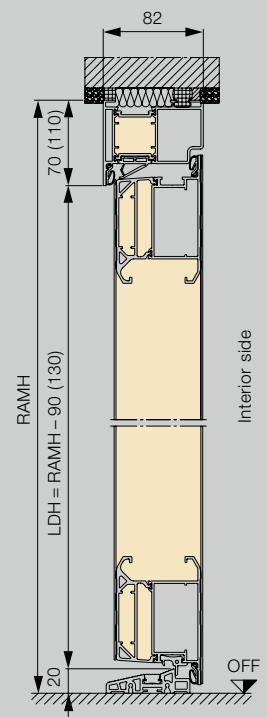

SIZES AND FITTING DATA

ThermoPlan Hybrid entrance door sizes

70 mm frame version	Overall frame dimension* (ordering size)	Structural opening*	Clear frame dimension
Standard	Max. 1250 × 2250	Max. 1270 × 2260	Max. 1110 × 2180
Oversize	Max. 1250 × 2350	Max. 1270 × 2360	Max. 1110 × 2280
XXL	Max. 1250 × 2500	Max. 1270 × 2510	Max. 1110 × 2430

ThermoPlan Hybrid side element sizes

Vertical profile construction	Side element height*	TM side element width*	TM entrance door width*
1-sided	Max. 3000	260 – 1600	Max. 1230
2-sided	Max. 3000	260 – 1600	Max. 1210

The max. transport size of a door assembly (incl. side elements, transom lights and surface-mounted profiles) must not exceed 2700 mm on any side.

Coupling construction	Side element height*	TM side element width*	TM entrance door width*
1- / 2-sided	Max. 3000	300 – 2500**	1250

* For 110 mm frames + 40 mm

** With Reflo or Micrograin

ThermoPlan Hybrid

Bottom spacer profile / transport protection

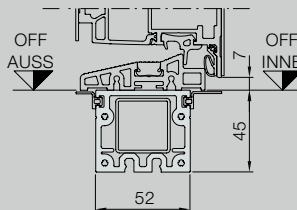
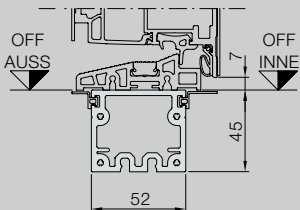

For vertical profile constructions with inserted, continuous tubular supports (shown on right).

Horizontal view of door

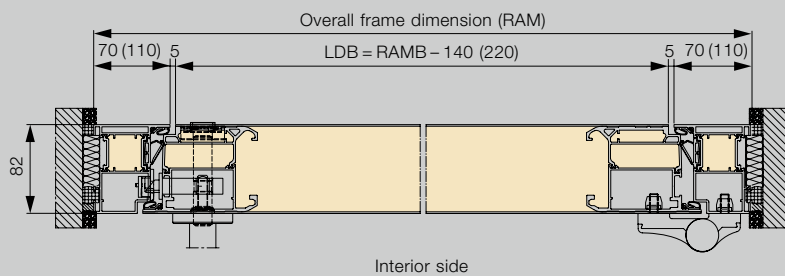

Vertical view of door

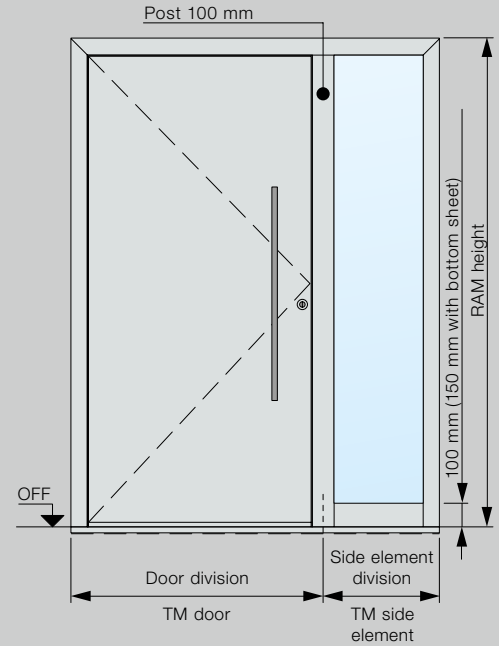
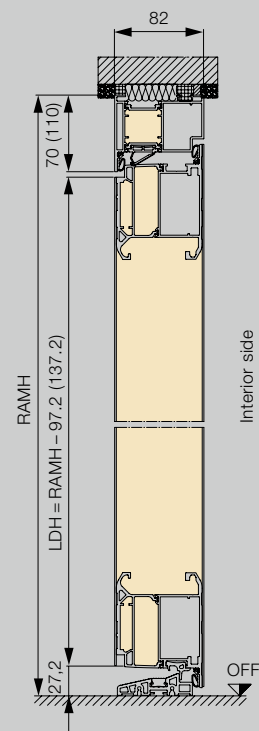

ThermoCarbon entrance door dimensions

Version	Overall frame dimension (ordering size)	Structural opening	Clear frame dimension
Standard	max. 1340 × 2350	Max. 1360 × 2360	Max. 1140 × 2230
XXL	Max. 1340 × 3000	Max. 1360 × 3010	Max. 1140 × 2880

ThermoCarbon side element dimensions

Vertical profile construction	Side element height	TM side element width	TM entrance door width
1-sided	Max. 3000	300 – 1600	Max. 1300
2-sided	Max. 3000	300 – 1600	Max. 1260

The max. transport size of a door assembly (incl. side elements, transom lights and surface-mounted profiles) must not exceed 2700 mm on any side.

Coupling construction	Side element height	TM side element width	TM entrance door width
1- / 2-sided	Max. 3000	340 – 1600	1340

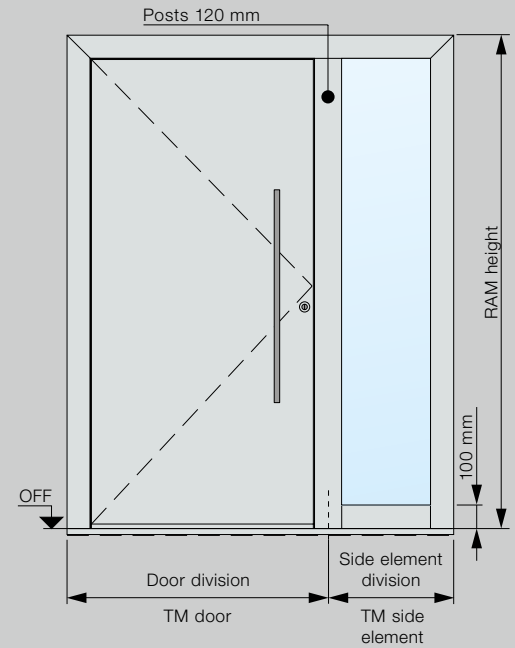

ThermoCarbon

Bottom spacer profile / transport protection

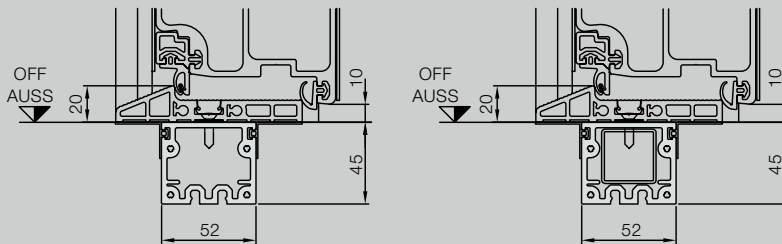

For vertical profile constructions with inserted, continuous tubular supports (shown on right).

Horizontal view of door

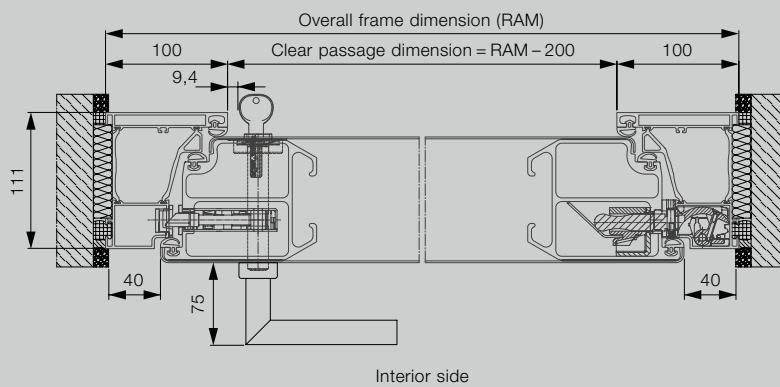

Vertical view of door

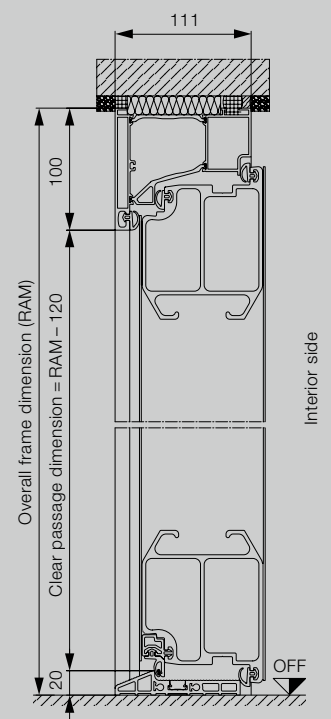

SIZES AND FITTING DATA

TopComfort entrance door sizes

70 mm frame version	Overall frame dimension* (ordering size)	Structural opening*	Clear frame dimension
Standard	Max. 1300 x 2500	Max. 1270 x 2510	Max. 1160 x 2430

TopComfort side element sizes

Vertical profile construction	Side element height*	TM side element width*	TM entrance door width*
1-sided	Max. 3000	260 – 1600	Max. 1230
2-sided	Max. 3000	260 – 1600	Max. 1210

The max. transport size of a door assembly (incl. side elements, transom lights and surface-mounted profiles) must not exceed 2700 mm on any side.

Coupling construction	Side element height*	TM side element width*	TM entrance door width*
1- / 2-sided	Max. 3000	300 – 1600	1250

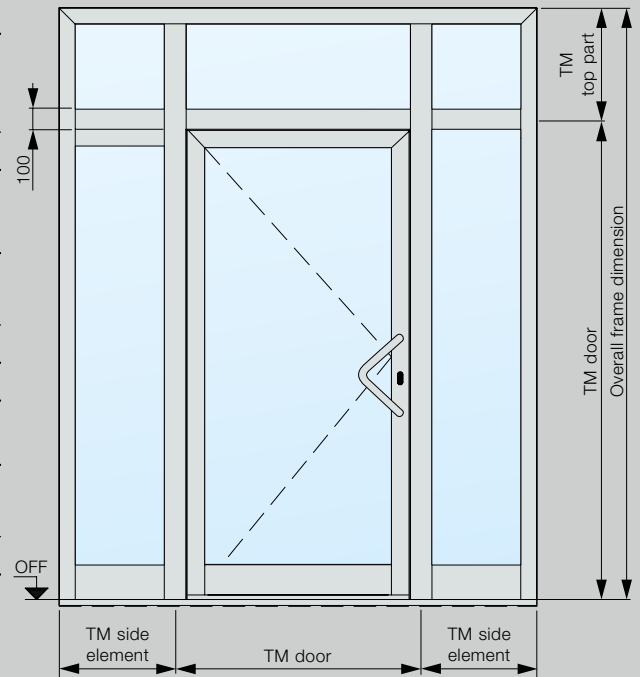

TopComfort

Bottom spacer profile

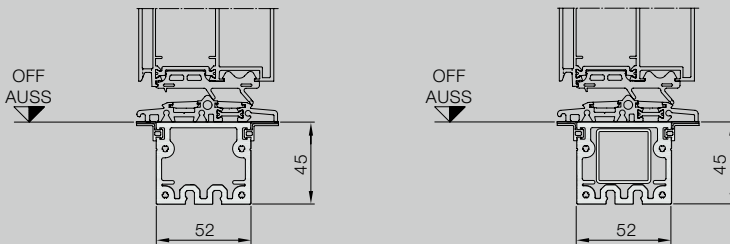

For vertical profile constructions with inserted, continuous tubular supports (shown on right).

Horizontal view of door

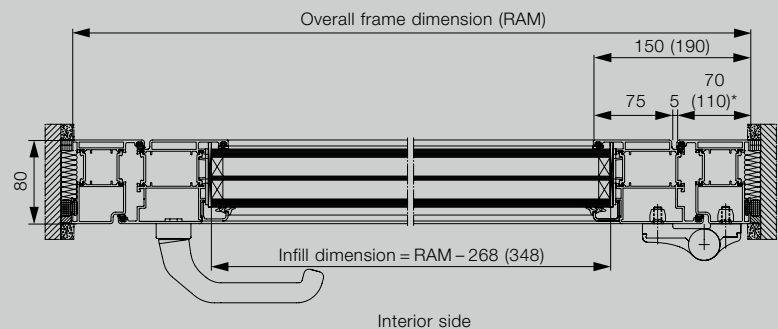

* Optional frame width

Vertical view of door

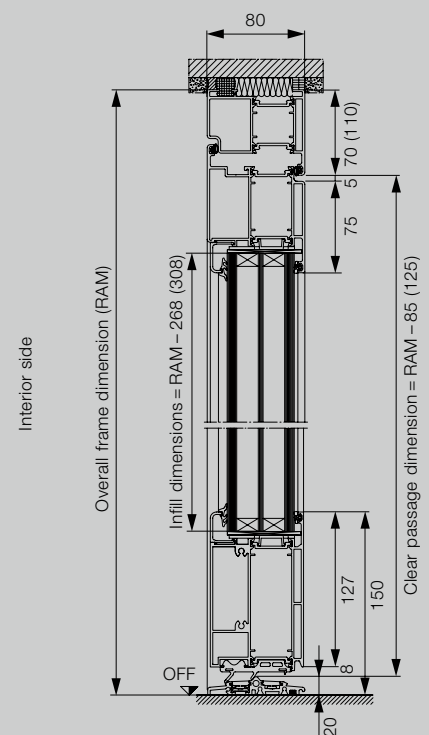

Experience Hörmann quality in new construction and modernisation

Hörmann provides an excellent basis for comprehensive planning. Carefully matched solutions offer you the very best in perfectly designed products for every area.

- **Garage doors**

Optimally match your personal architectural style: up-and-over or sectional doors made of steel or timber.

- **Gate and door operators**

Enjoy extra convenience and break-in-resistant security with Hörmann operators for garage doors and entrance gates. You can profit from the convenience of Hörmann door operators in your residential space as well.

- **Entrance doors**

Our comprehensive entrance door ranges include models that fit almost every need and requirement.

- **Residential internal doors**

Our high-quality timber and glass doors give your home an extra level of comfort and integrate harmoniously into the overall appearance of your home.

- **Steel doors**

Sturdy doors for your entire home, from basement to roof.

- **Frames**

Choose from our comprehensive range of products for new construction, expansion and modernisation.



Garage doors and entrance gate operators



Residential internal doors and door operators



Steel doors

Hörmann: Quality without Compromise



Hörmann KG Amshausen, Germany



Hörmann KG Antriebstechnik, Germany



Hörmann KG Brandis, Germany



Hörmann KG Brockhagen, Germany



Hörmann KG Dissen, Germany



Hörmann KG Eckelhausen, Germany



Hörmann KG Freisen, Germany



Hörmann KG Ichtershausen, Germany



Hörmann KG Werne, Germany



Hörmann Alkmaar B.V., Netherlands



Hörmann Legnica Sp. z o.o., Poland



Hörmann Beijing, China



Hörmann Tianjin, China



Hörmann LLC, Montgomery IL, USA



Hörmann Flexon LLC, Burgettstown PA, USA



Shakti Hörmann Pvt. Ltd., India

Hörmann is the only manufacturer worldwide that offers you a complete range of all major building products from one source. We manufacture in highly-specialised factories using the latest production technologies. The close-meshed network of sales and service companies throughout Europe, and activities in the USA and Asia, make Hörmann your strong partner for first-class building products, offering “Quality without Compromise”.

GARAGE DOORS
OPERATORS
INDUSTRIAL DOORS
LOADING EQUIPMENT
HINGED DOORS
DOOR FRAMES