



Thermo65 / Thermo46 entrance doors

NEW: Hörmann Matt deluxe colours for timeless and elegant door design

HÖRMANN





CONTENT

6	Good reasons to try Hörmann
10	Programme overview
12	Thermo65
22	Thermo46
30	Security equipment
32	Automatic locks, glazings
34	Handles, embellishments
36	Colours and surface finishes
39	Performance characteristics
40	Dimensions and fitting data
42	Hörmann product range

The colours and surface finishes shown are subject to the limitations of the printing process and cannot be regarded as binding.

Some of the products and equipment details described and illustrated in this catalogue are not standard, but available for a surcharge depending on the equipment option. Please contact your Hörmann Partner with reference to the current price list for specific door equipment.

Descriptions and pictures, information about the scope of delivery, equipment and colour correspond to the time of printing. Subject to changes and errors.

All rights reserved. No part may be reproduced without our prior permission.

◀ **Thermo65 style 700** in Decograin Golden Oak, stainless steel handle HB 38-2, with side elements

There's no place like home

What's better than coming home after a long day at work and enjoying family life? You can eat, play board games and watch TV together. To be able to enjoy time with your loved ones, you have to feel safe and at ease in your own four walls.

Hörmann Thermo65 and Thermo46 entrance doors will help you with that. Our high-quality construction components feature excellent thermal insulation values, reliable security equipment, a large selection of styles and an attractive price-performance ratio. You are sure to find a Hörmann door that meets your demands on the following pages.





“A good reputation must be earned.”

August Hörmann

In keeping with the tradition started by the company's founder, the name Hörmann delivers brand name quality with extensive product expertise. The family business has over 80 years of experience as a construction component specialist and sees itself as your partner from the very beginning of building and renovation projects. It's no surprise that Hörmann is one of Europe's most successful entrance door providers. All this makes Hörmann entrance doors a reassuring purchase.



1 Made in Germany

The entrance door construction is developed and manufactured by Hörmann. Our highly qualified employees work intensively on new products, continual further developments and improvements to details. The results are patents and unique products on the market. Endurance tests under real conditions ensure **mature series products with Hörmann quality.**

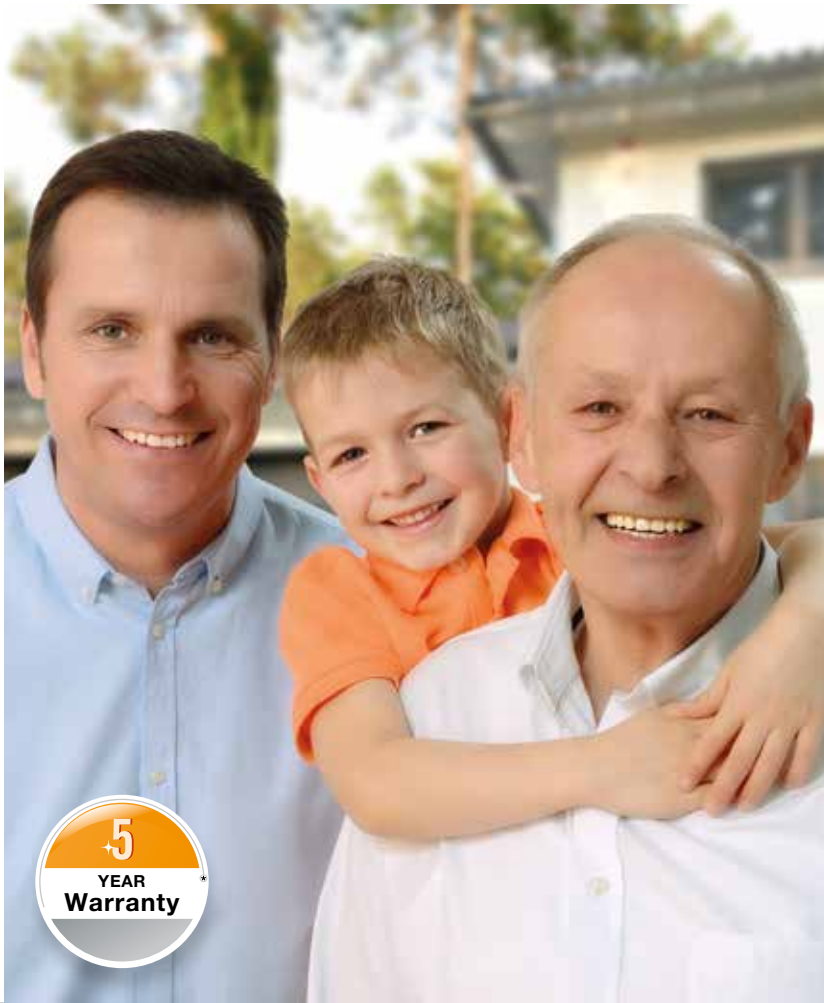

2 Quality products for generations

We are convinced of our products and our uncompromising quality assurance. This is why Hörmann issues a **5-year guarantee*** on all Thermo65 / Thermo46 entrance doors.

3 An eye on the future

Hörmann is setting a good example. This is why the company obtains **100 % of its energy consumption from green sources**. Together with an intelligent and certified energy management system, CO₂-neutral mailing and the recycling of valuable materials, **more than 40000 tons of CO₂ are saved each year**. And last but not least, Hörmann also offers products for sustainable construction.

* The complete warranty conditions can be found at: www.hormann.co.uk



4 Door leaf without visible leaf profile

Thermo65 and Thermo46 doors make for an exquisite and elegant reception – whether you use them for a main or a side entrance. **The shapely door leaf with its solid interior and exterior and the leaf profile on the inside fulfils the highest design requirements.** The interior view (shown on page 30) harmonises perfectly with your residential doors.

5 High thermal insulation

With U_D -values up to approx. $1.1 \text{ W}/(\text{m}^2\cdot\text{K})^*$, Thermo46 entrance doors provide excellent thermal insulation for your home. **Thermo65 entrance doors feature a U_D -value of up to approx. $0.87 \text{ W}/(\text{m}^2\cdot\text{K})^*$ for even better thermal insulation.** As a result, you save energy in the long term while also protecting the environment.



External view of entrance doors from other manufacturers with visible leaf profile



Interior view of entrance doors from other manufacturers with visible leaf profile and glazing beads



6 Break-in-resistant locking

For you and your family, being able to rest easy in your own home is important. This is why our **Thermo65 / Thermo46 doors are equipped with multiple-point locking as standard.**

For even more security, many Thermo46 door styles as well as many Thermo65 entrance doors (including with side elements and transom lights) are **optionally available with break-in-resistant RC 2 security equipment.**

7 Safe glazing



8 mm laminated safety glass on the interior and exterior as standard

When it comes to **industrial safety and burglar protection**, Hörmann entrance doors fulfil the absolute highest demands. The laminated safety glass on the interior and exterior of the triple-pane insulated glazing provides **maximum security**. In case of glass breakage, the glass splinters are also bound on the inside, **virtually eliminating any danger of being injured by the shards**. Furthermore, the laminated safety glass offers better protection against burglars as it makes reaching through more difficult.

Steel / aluminium entrance door Thermo65

Thanks to the solid door view from the inside, the high-quality Thermo65 doors perfectly match the timber internal doors of your home. You can enjoy the same door view of doors made of different materials for many years to come.

Construction

- 1 Solid, 65 mm thick steel door leaf with leaf profile on the inside and thick rebate for an elegant door appearance
- 2 Leaf profile made of composite material with thermal break for high stability and thermal insulation
- 3 80 mm aluminium frame with thermal break and 20 mm high aluminium / plastic threshold rail with thermal break ensures excellent thermal insulation
- 4 Triple sealing offers optimal protection from rain, wind and dirt

Triple-pane insulated glazing with safety glass on both sides virtually eliminates all risk of injury in the event of breakage

Optional RC 2 security equipment for extra security**

Fulfils all requirements of the energy savings regulation

Suitable for fitting without thermal bridges

Thermal insulation: U_D-value of up to approx. 0.87 W/(m²·K)*

Acoustic insulation: R_{w,p} up to 32 dB

The complete performance characteristics can be found on page 39.



Optional

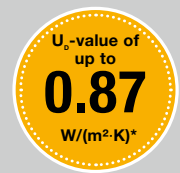

* Approved by IFT
Rosenheim, door size
RAM 1230 x 2180 mm
**Not for THP 410S,
430E, 600S

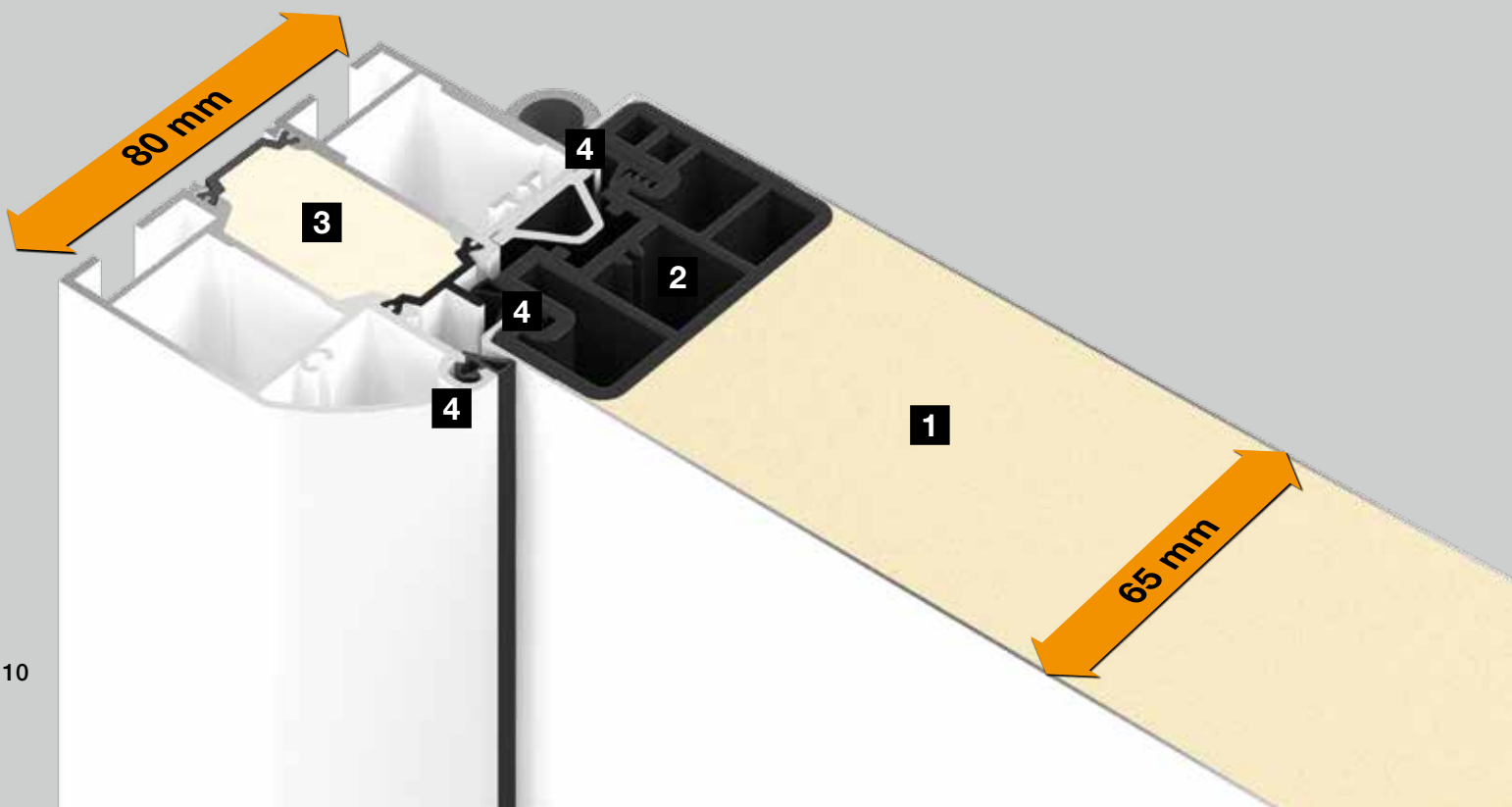

Steel / aluminium entrance door Thermo46

All Thermo46 doors are delivered with a solid door leaf to give your entrance doors and residential doors a uniform view from the inside.

Construction

- 1 Solid, 46 mm thick steel door leaf with leaf profile on the inside and thick rebate for an elegant door appearance
- 2 Leaf profile made of composite material with thermal break for good stability and thermal insulation
- 3 60 mm aluminium frame with thermal break and 20 mm high aluminium / plastic threshold rail with thermal break ensures good thermal insulation
- 4 Double sealing offers good protection from rain, wind and dirt

Double-pane insulated glazing with safety glass on both sides virtually eliminates all risk of injury in the event of breakage

Optional RC 2 security equipment for extra security**

Fulfils all requirements of the energy savings regulation

Suitable for fitting without thermal bridges

Thermal insulation: U_D -value of up to approx. $1.1 \text{ W}/(\text{m}^2\cdot\text{K})^*$

Acoustic insulation: $R_{w,p}$ up to 32 dB

The complete performance characteristics can be found on page 39.



Optional



* Approved by IFT
Rosenheim, door size
RAM 1230 x 2180 mm
**Not for TPS 020S,
025S, 030S, 040S,
200I, 400I

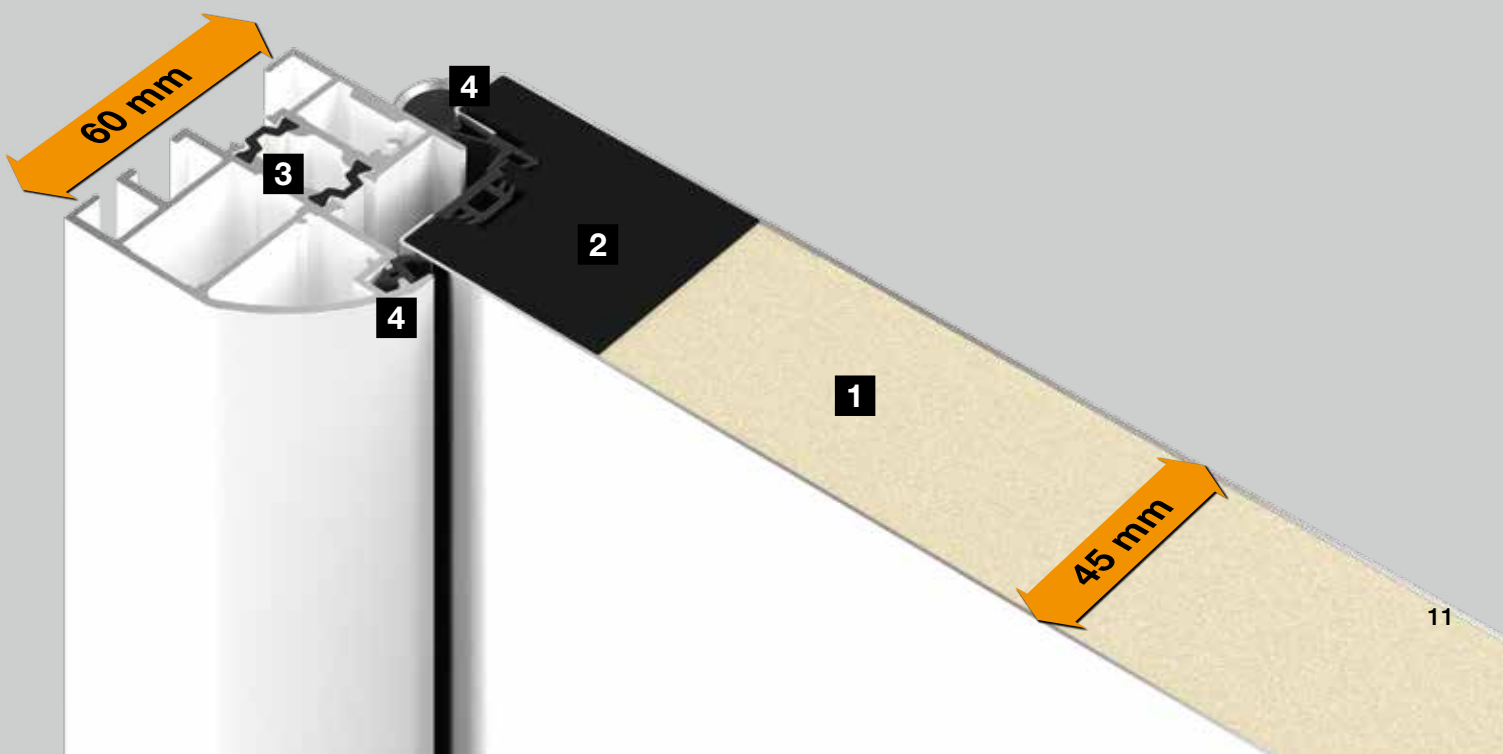



The entrance door that makes you feel welcome

The Thermo65 offers you everything that makes for an excellent entrance door. The solid 65 mm thick steel door leaf with PU rigid foam infill and the leaf profile on the inside made of composite material as well as the aluminium frame with thermal break keep the cold out. With a U_D -value up to approx. $0.87 \text{ W}/(\text{m}^2 \cdot \text{K})$, Thermo65 doors feature good thermal insulation. As standard, the doors are equipped with a 5-point security lock, allowing you to feel safe and secure in your home. Most Thermo65 styles are optionally available with RC 2 security equipment to make you feel even more secure in your own four walls.

Choose your favourite of 14 attractive styles and customise it with one of our 17 preferred colours, 6 exclusive Matt deluxe colours and 5 Decograin decors.





Style 015

Decograin Titan Metallic CH 703 with embellishment view 400 in stainless steel look, stainless steel handle HB 14-2



Style 015

Standard colour Traffic white RAL 9016, stainless steel handle HB 14-2



Style 515

Standard colour Traffic white RAL 9016, silk matt, stainless steel handle HB 14-2



Style 010

Preferred colour White aluminium RAL 9006, stainless steel embellishment view 751, stainless steel handle HB 14-2



Style 010

Decograin Golden Oak, stainless steel handle HB 14-2, side elements with Satinato glazing





Style 600S

Decograin Winchester Oak, stainless steel handle HB 38-2, with surface-mounted Satinato glazing, side elements with Satinato glazing

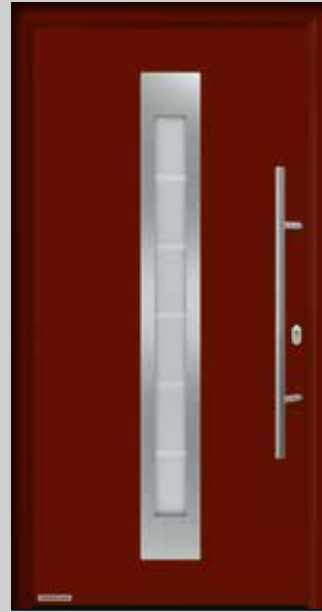

Style 750C

Preferred colour Purple red RAL 3004, silk matt, stainless steel handle HB 38-2, sand-blasted glazing with 5 clear stripes



Style 700B

Preferred colour Matt deluxe CH 9007 Grey aluminium ■ **NEW** stainless steel handle HB 38-2, sand-blasted glazing with 7 clear stripes



Style 850B

Standard colour Traffic white RAL 9016, silk matt, stainless steel handle HB 38-2, sand-blasted glazing with clear stripes



Style 800S

Preferred colour Window grey RAL 7040, silk matt, stainless steel handle HB 38-2, Satinato glazing



Style 810E

Standard colour Traffic white RAL 9016, silk matt, stainless steel handle HB 38-2, sand-blasted glazing with clear stripes (square)



Style 900D

Standard colour Traffic white RAL 9016, silk matt, stainless steel handle HB 38-2, sand-blasted glazing with 4 clear stripes



Style 820S ■ NEW

Decograin Titan Metallic CH 703, stainless steel handle HB 38-2, Satinato glazing







Style 100

Standard colour Traffic white RAL 9016, silk matt, stainless steel handle HB 14-2, side elements with Satinato glazing



Style 430E

Standard colour Traffic white RAL 9016, silk matt, stainless steel handle HB 14-2, glazing with clear stripes (frame)



Style 410S

Standard colour Traffic white RAL 9016, silk matt, stainless steel handle HB 14-2, Satinato glazing



Turn your entrance into an eye-catcher

The Thermo46 doors offer you everything that makes for an excellent entrance door. With a U_D -value up to approx. $1.1 \text{ W}/(\text{m}^2 \cdot \text{K})$, Thermo46 doors achieve excellent thermal insulation values. Thanks to the standard 5-point security lock, the entrance doors are well equipped when it comes to security. Some styles are optionally available with RC 2 security equipment to make you feel even more secure in your own four walls.

Choose your favourite from 13 door styles – from modern to classic. You can customise your Hörmann door with colours, glazings, side elements and transom lights according to your preferences.





Style 700B

Decograin Titan Metallic
CH 703, stainless steel handle
HB 38-2, sand-blasted
glazing with 7 clear stripes



Style 750C

Standard colour Traffic
white RAL 9016, silk matt,
stainless steel handle
HB 38-2, sand-blasted
glazing with 5 clear stripes



Style 900D

Decograin Golden Oak,
stainless steel handle
HB 38-2, sand-blasted
glazing with 4 clear stripes



Style 515

Decograin Titan Metallic
CH 703 with embellishment
view 400 in stainless steel
look, stainless steel handle
HB 14-2



Style 015

Standard colour Traffic white
RAL 9016, silk matt,
stainless steel handle
HB 14-2



Style 025S

Standard colour Traffic white
RAL 9016, silk matt,
with embellishment view 400
in stainless steel look,
stainless steel handle
HB 14-2, Satinato glazing



Style 010

Preferred colour Anthracite grey RAL 7016, stainless steel handle HB 14-2, side elements with Satinato glazing



Style 020S

Standard colour Traffic white RAL 9016, silk matt, stainless steel handle HB 14-2, Satinato glazing



Style 030S

Preferred colour Window grey RAL 7040, stainless steel handle HB 14-2, Satinato glazing



Style 040S

Standard colour Traffic white RAL 9016, silk matt, stainless steel handle HB 14-2, round glazing Ø 280 mm, Satinato glazing







Style 100

Standard colour Traffic white RAL 9016, silk matt, stainless steel handle HB 14-2, side elements with Cathedral glass



Style 200

Standard colour Traffic white RAL 9016, silk matt, stainless steel handle HB 14-2, Cathedral glass



Style 400I

Standard colour Traffic white RAL 9016, silk matt, stainless steel handle HB 14-2, Cathedral glass

Reassuring security



Interior view

5-point security lock

You will feel safe at home: 2 conical swing bolts **4** engage with 2 additional security bolts **3** and 1 lock bolt **2** in the frame's lock plate and pull the door tightly shut. The lock plate on Thermo65 doors is adjustable for an optimal door setting. Thanks to the soft-lock latch **1**, the door closes very quietly.



Securing the hinge side

Being able to rest easy in your own home is important, which is why your Thermo46 / Thermo65 door is secured additionally on the hinge side, making it practically impossible to force the door open.

5 Thermo46

With 3 security bolts

6 Thermo65

With continuous security strip made of aluminium

7 Perfectly hung with 3-way adjustable guide rollers

Sturdy, two-part 3-way adjustable hinges with safety pins and decorative covers in stainless steel look guarantee smooth door function.

8 Interior lever

Each door comes with a beautifully shaped stainless steel interior lever as standard.

9 Exterior rose escutcheon

Thermo65 and Thermo46 doors come with a stainless steel exterior rose escutcheon as standard. The security sliding rose escutcheon for Thermo65 doors makes it more difficult to manipulate the locking cylinder, making it ideally equipped in terms of security.

10 Profile cylinder

Delivered with 5 keys as standard. With emergency and hazard function, i.e. the door lock can still be operated when the key is inserted on the inside.

Frame variants

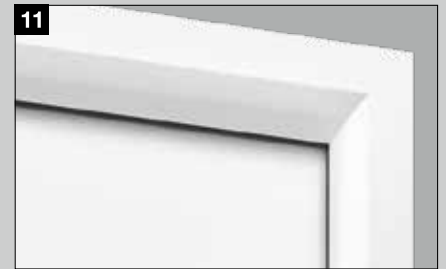

The 60 mm or 80 mm aluminium frame with thermal break and PU foam infill is available in either a round-style **11** (A 1 / A 3) or rectangular profile **12** (A 2 / A 4), without a surcharge.

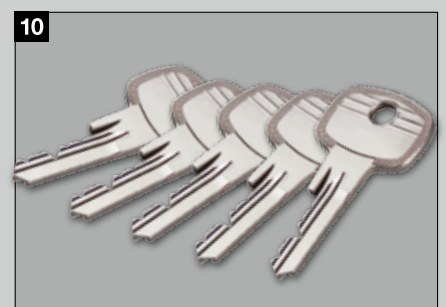
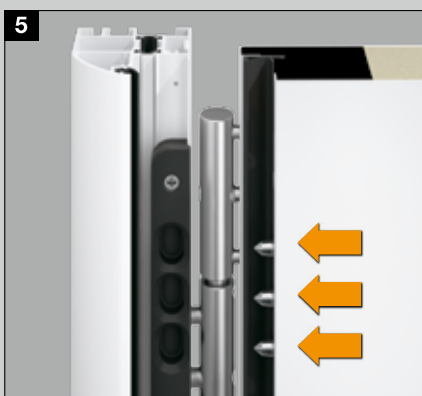

Automatic lock with mechanical self-locking

(for Thermo65)

When the door falls shut, the bolts automatically extend and securely lock the entrance door.

Automatic lock with electric motor and opening via BiSecur radio

(for Thermo65)

Open your entrance door easily and conveniently via multiple-point locking using a hand transmitter, code switch or radio finger-scan*. There's no longer any danger of forgetting your keys. Your entrance door automatically unlocks via an electric motor. You can then push the door open.

1 Hand transmitter HSE 4 BS black textured surface with black plastic caps

2 Radio code switch FCT 3-1 ■ **NEW**

3 Radio finger-scan FFL 25 BS ■ **NEW**

4 Finger-scan integrated in the door leaf (for Thermo65)

Open your entrance door with your fingerprint! The finger-scan is elegantly integrated in the door leaf and is available for all Thermo65 entrance doors equipped with an automatic lock with electric motor.

5 Automatic lock with electric motor and opening via Bluetooth

(for Thermo65)

Opening and closing your door via Bluetooth using your smartphone is even more convenient. Lock and unlock your Thermo65 entrance doors with optional automatic lock with electric motor and opening via Bluetooth using the user-friendly Hörmann BlueSecur app.

Electric strike (for Thermo65 and Thermo46, not shown)

With the electric strike catch, you can conveniently open your door via a switch inside the house.

Reed contact (for Thermo65 and Thermo46) and bolt switch contact (for Thermo65, not shown)

For connection to the building technology or alarm system and evaluation that the door is closed (reed contact) or locked (bolt switch contact).

6 Letter plate (for Thermo46 styles 100 / 200 / 400)

Shown in silver

7 Spy Viewer (for Thermo46 styles 100 / 200 / 400)

For doors without windows (Optional extra)

Door drip

(for Thermo65 and Thermo46, not shown)

Attractive protection: The door drip in Traffic white RAL 9016 or in stainless steel diverts driving rain and can also be easily retrofitted.

Retractable bottom seal (for Thermo65 and Thermo46, not shown)

This optional equipment is the best solution for sealing entrance doors without threshold rail used for barrier-free entrances.

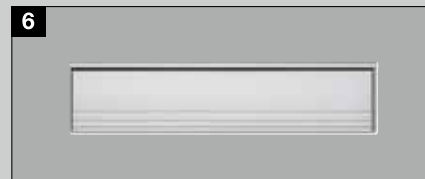

* Changing fingerprint characteristics in children, adolescents and the elderly can cause malfunctions. For temperature ranges from -20 °C to +80 °C.

Glazings for doors



Thermo65
With triple-pane glazing
Style 700 / 750 / 800 /
810 / 820 / 850 / 900

Thermo46 with
triple-pane glazing
Style 700 / 750 / 900

These styles offer a nearly flush-fitting view on the inside and outside. The stainless steel glazing frame complements the elegant overall appearance. Insulated glazing is convincing when it comes to saving energy thanks to high thermal insulation values.



Thermo46
With double-pane glazing
Style 020 / 025 / 030 / 040

These doors are equipped with insulated glazing, guaranteeing excellent thermal insulation. A modern, harmonious overall door appearance is created with a round-style plastic glazing frame. With Decograin surfaces, the glazing frame is painted in a colour complementing the surface finish.



Thermo65
With triple-pane glazing
Style 410 / 430

Thermo46 with double-pane Cathedral glazing
Style 200 / 400

Panelled door styles are a stylish way to present your home with their perfectly matching profile-style plastic glazing frames. When it comes to thermal insulation, insulated glazing gives you everything you could want from a high-quality Hörmann entrance door.



Thermo65
With triple-pane glazing
Style 600

The black contrast frame gives the surface-mounted glazing an elegant appearance. Insulated glazing also ensures high thermal insulation, as you would expect in a modern entrance door.

Glazings for side elements and transom lights

Thermo46 doors are supplied with side elements and transom lights with double-pane insulated glazing, Thermo65 doors with triple-pane insulated glazing.



Satinato



Sand-blasted / sand-blasted with clear stripes



Clear glass



Cathedral small hammered finish (only Thermo46)

A beautiful handle accents the door:
select your
desired handle

Exterior handles

As standard, all doors come with the exterior handles shown in the product photos (from page 14). Alternatively, you can select a different handle made of stainless steel.

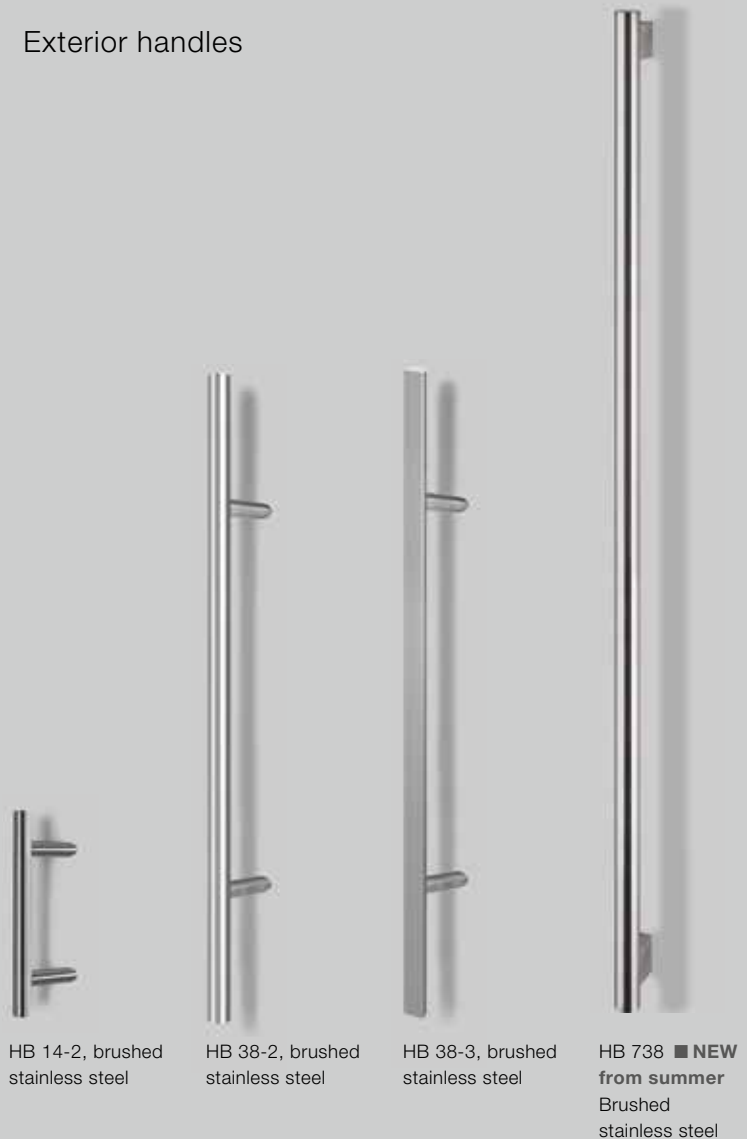

Lever handle sets for outside and inside

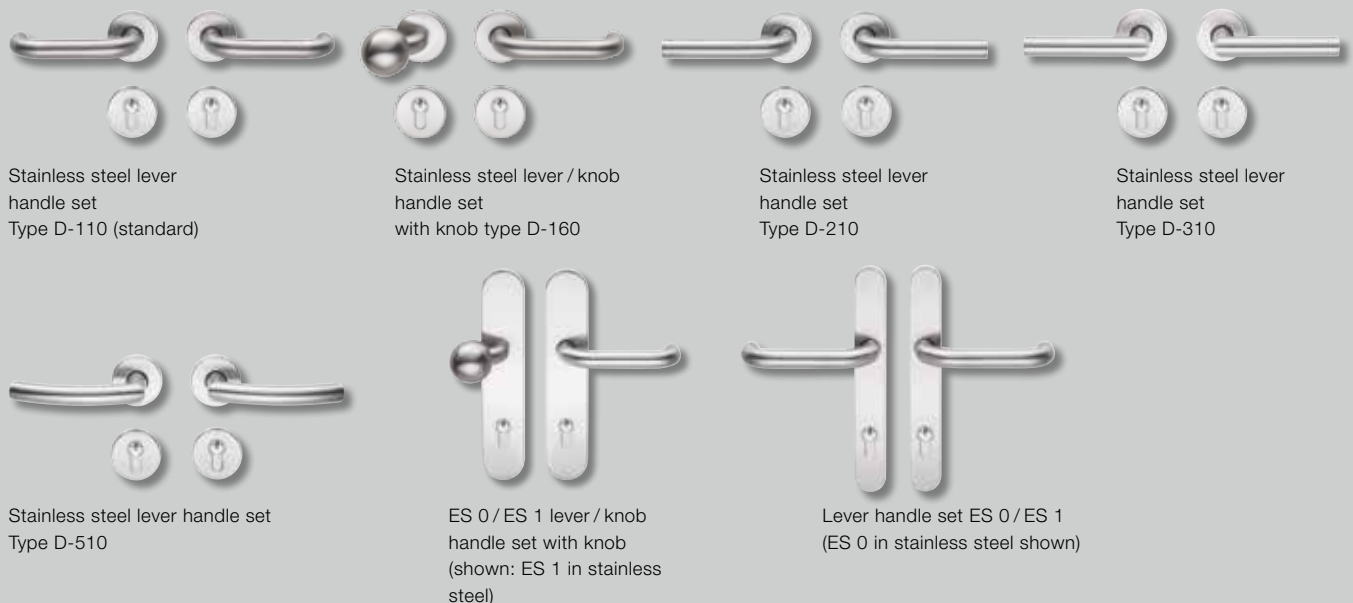

Embellishments make your entrance look more beautiful

Design the exterior of styles 010, 015, 025 and 515 using these attractive embellishments. The embellishments made of stainless steel or in a stainless steel look are available for Thermo65 and Thermo46 door versions and for all door colours or decors.



Style 015, view 400



Style 515, view 401



Style 025, view 402



Style 015, view 403



Style 010, view 451



Style 010, view 454



Style 010, view 457



Style 010, view 459



Style 010, view 750



Style 010, view 751

Find your favourite colour

Do you prefer a subtle Window grey or would you like to show your true colours with Ruby red? When choosing a colour for your new Hörmann entrance door, we let your creativity run wild. You can choose between the particularly inexpensive Traffic white RAL 9016 and 17 additional preferred colours. The interior and exterior of your Thermo65 or Thermo46 doors are always the same colour. Simply contact your Hörmann partner.

In low-cost Traffic white as standard



1

17 preferred colours



2

3



4

5



6

7



8

9



10

11



12

13

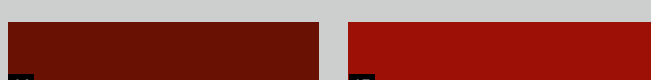

14

15



16

17



18

- 1 RAL 9016 Traffic white
- 2 RAL 9007 Grey aluminium
- 3 RAL 9006 White aluminium
- 4 RAL 9002 Grey white
- 5 RAL 9001 Cream
- 6 RAL 8028 Terra brown
- 7 RAL 8003 Clay brown
- 8 RAL 7040 Window grey
- 9 RAL 7035 Light grey
- 10 RAL 7016 Anthracite grey
- 11 RAL 6005 Moss green
- 12 RAL 5014 Pigeon blue
- 13 RAL 5010 Gentian blue
- 14 RAL 3004 Purple red
- 15 RAL 3003 Ruby red
- 16 RAL 3000 Flame red
- 17 RAL 1015 Light ivory
- 18 CH 703 Anthracite metallic

Please note:

The colours and surface finishes shown are subject to the limitations of the printing process and cannot be regarded as binding. Dark colours should not be used for doors that are exposed to the sun, as an increased material expansion may impair the door's function.

* Not available for Thermo65 styles 100, 410, 430 and Thermo46 styles 100, 200, 400. Glazing frames in matching colours for Thermo46 styles 020, 025, 030, 040.

Timeless and elegant

The exclusive Hörmann Matt deluxe colours impress with their fine elegance. Choose between six trendy colours for a modern and timeless door design.

6 colours Matt deluxe ■ NEW



- 1 CH 9016 Matt deluxe Traffic white
- 2 CH 9006 Matt deluxe White aluminium
- 3 CH 9007 Matt deluxe Grey aluminium
- 4 CH 7016 Matt deluxe Anthracite grey
- 5 CH 8028 Matt deluxe Terra brown
- 6 CH 703 Matt deluxe Anthracite metallic

Detailed and natural look

Decograin* is available in four natural-looking timber designs and one anthracite design with a metallic effect. An embossed wood grain gives it an authentic timber character.

5 Decograin decors*

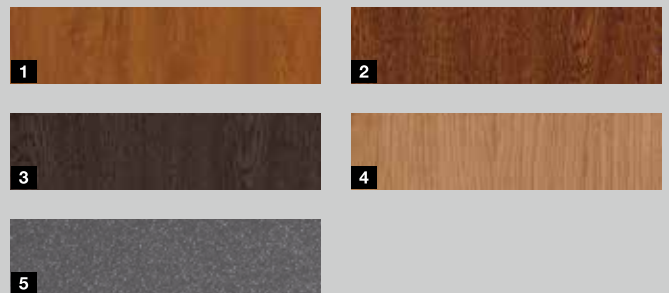

- 1 Golden Oak: medium brown, golden yellow oak design
- 2 Dark Oak: walnut-coloured oak decor
- 3 Night Oak: dark, intense oak design
- 4 Winchester Oak: natural-coloured knotty oak design
- 5 Titan Metallic CH 703: Anthracite with a metallic effect

Customise your door to fit your needs

Give your entrance door an individual look and combine the door leaf and frame in different colours for Thermo65 and Thermo46 entrance doors.

Entrance doors matching internal doors

Entrance door Thermo65 is available in Decograin Golden Oak, Dark Oak and Titan Metallic, and in Traffic white RAL 9016 on the inside to perfectly match your white internal doors.

Please note:

The colours and surface finishes shown are subject to the limitations of the printing process and cannot be regarded as binding. Dark colours should not be used for doors that are exposed to the sun, as an increased material expansion may impair the door's function.

Door leaf and frame in different colours



Frame in White aluminium RAL 9006, door leaf in Titan Metallic CH 703



Frame in Titan Metallic CH 703, door leaf in Traffic white RAL 9016

Two-colour entrance doors and side elements



Viewed from outside in Decograin surface



Viewed from inside in Traffic white RAL 9016*

Performance characteristics

Our entrance doors offer reliable functional safety and approved performance characteristics. This allows you to enjoy your Hörmann entrance door for years to come.



Performance characteristics

	Thermo65	Thermo46
Operating forces EN 12217	Up to class 3	Up to class 2
Long-term functionality / mechanical load EN 12400	Up to class 6	Up to class 5
Differential climate behaviour EN 12219	Up to 2d / 2e	Up to 3c / 2d / 2e
Air permeability EN 12207	Up to class 4	Up to class 2
Water tightness under heavy rain EN 12208	Up to class 3A	Up to class 1A
Resistance to wind load EN 12210	Up to class C3 / B3	Up to class C3
Impact resistance EN 13049	Up to class 1	Up to class 1
Mechanical strength EN 1192	Up to class 3	Up to class 1
Thermal insulation	Up to 0.87 W/(m ² ·K)	Up to 1.1 W/(m ² ·K)
Acoustic insulation	Up to 32 dB	Up to 32 dB
Burglar protection EN 1627 (optional)	RC 2 (optional)	RC 2 (optional)

SIZES AND FITTING DATA

Standard sizes Thermo65

Overall frame dimension (ordering size)	Clear passage*
1,000 × 2,100	850 × 2,005
1,100 × 2,100	950 × 2,005

Standard European sizes Thermo46

Overall frame dimension (ordering size)	Clear passage*
1,000 × 2,100	872 × 2,016
1,100 × 2,100	972 × 2,016

Special sizes Thermo65 / Thermo46

Styles	Overall frame dimension (ordering size)
200	875 – 1,100 × 1,990 – 2,186
010, 020, 030, 040, 600, 700, 750, 800, 810	700 – 1,250 × 1,875 – 2,250
015, 025, 515	875 – 1,250 × 1,875 – 2,250
100, 400, 410, 430	875 – 1,100 × 1,875 – 2,186
820, 850, 900	800 – 1,250 × 1,875 – 2,250

* The clear passage width does not allow for the handle projection on the width.

Thermo65

Frame variants

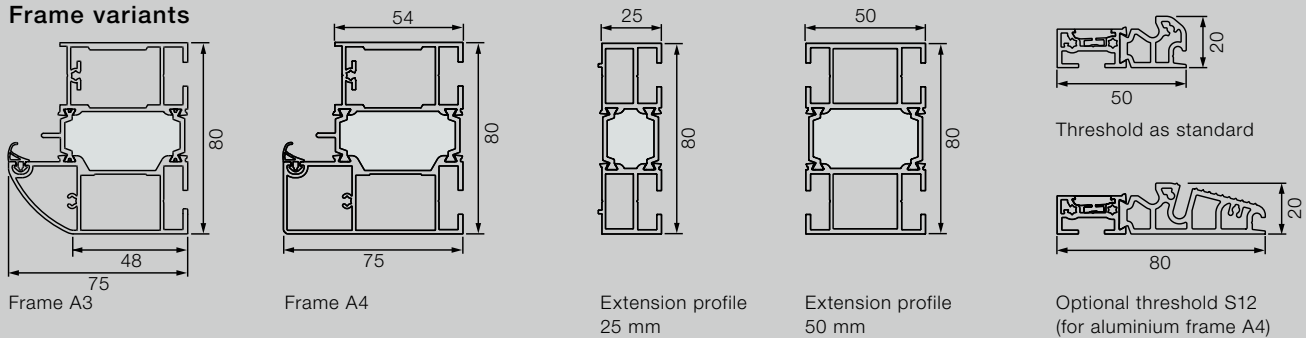

Horizontal view of door

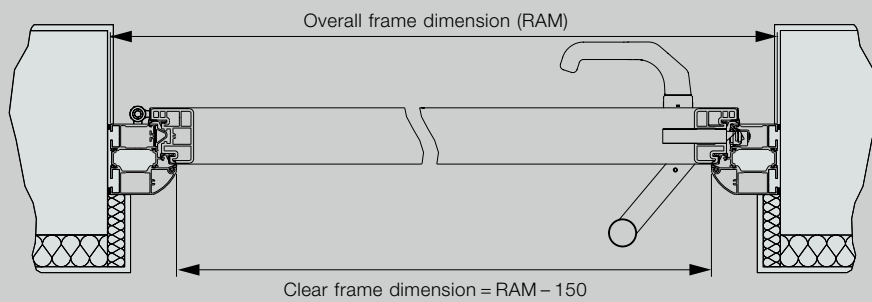

Vertical view of door

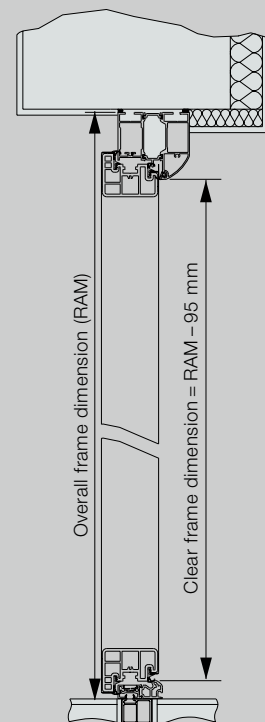

Horizontal view of side element

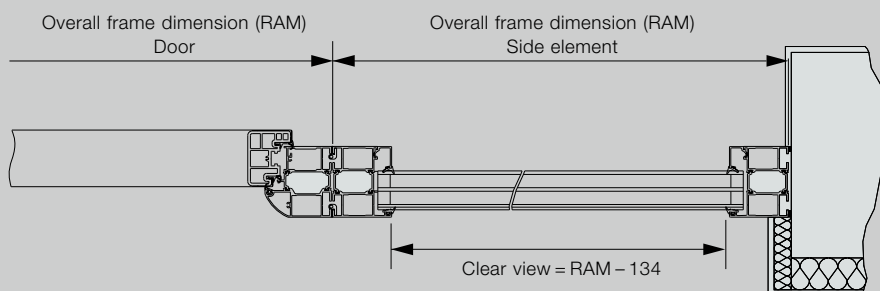

Side element standard sizes
Thermo65 / Thermo46

Version	Overall frame dimension (ordering size)
Thermo 65 / 46	400 × 2,100

Side element special sizes
Thermo65 / Thermo46

Versions	Overall frame dimension (ordering size)
Thermo46	300 – 1,000* × 700 – 2,250
Thermo65	300 – 1,000* × 700 – 2,250

* Transom light not possible from a width of 500 mm. Door sets with side elements do not contribute to the static equilibrium, which must be guaranteed by the building structure.

Transom light special sizes
Thermo65 / Thermo46

Version	Overall frame dimension (ordering size)
Thermo 65 / 46	700 – 2,250 × 300 – 500

Thermo46

Frame variants

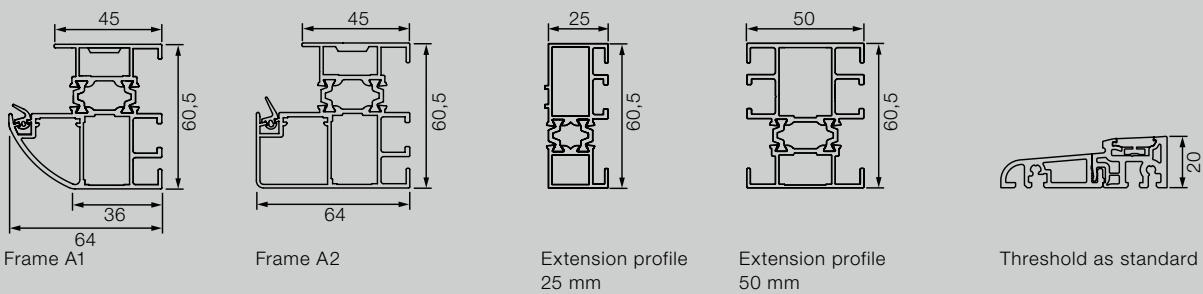

Horizontal view of door

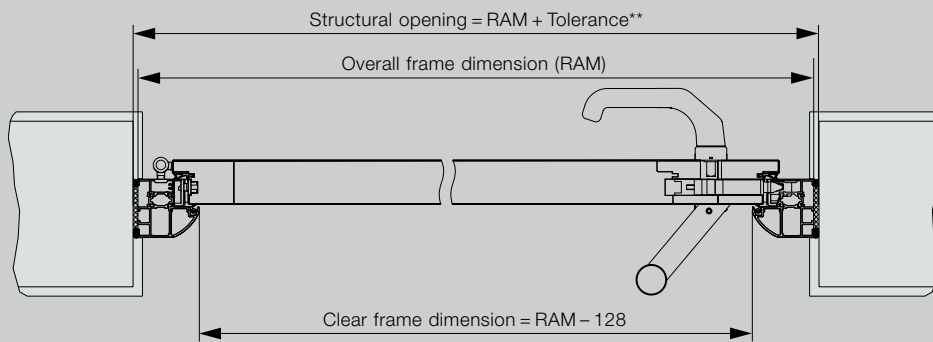

Vertical view of door

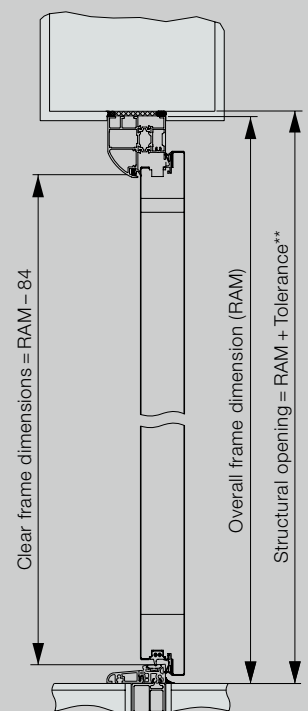

Horizontal view of side element

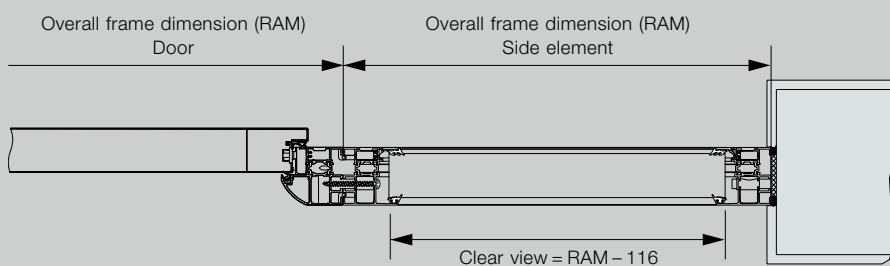

** The structural opening height is based on the finished floor dimension which includes any and all floor coverings. (Please note that each application/project is unique and the tolerance may alter) These doors are rebated on all four sides, failure to take the floor covering into consideration could prevent the door from opening.

All dimensions in mm



Experience Hörmann quality in new construction and modernisation

Hörmann provides an excellent basis for comprehensive planning. Carefully matched solutions offer you the very best in perfectly designed products for every area.

- **Garage doors**

Optimally match your personal architectural style: up-and-over or sectional doors made of steel or timber.

- **Gate and Door Operators**

Enjoy extra convenience and break-in-resistant security with Hörmann operators for garage doors and entrance gates. You can profit from the convenience of Hörmann door operators in your residential space as well.

- **Entrance doors**

Our comprehensive entrance door ranges include models that fit almost every need and requirement.

- **Steel doors**

Sturdy doors for your entire home, from basement to roof.

- **Frames**

Choose from our comprehensive range of products for new construction, expansion and modernisation.



Garage doors and entrance gate operators



Thermo65 / Thermo46 entrance doors



Steel doors

Hörmann: Quality without Compromise



Hörmann KG Amshausen, Germany



Hörmann KG Antriebstechnik, Germany



Hörmann KG Brandis, Germany



Hörmann KG Brockhagen, Germany



Hörmann KG Dissen, Germany



Hörmann KG Eckelhausen, Germany



Hörmann KG Freisen, Germany



Hörmann KG Ichttershausen, Germany



Hörmann KG Werne, Germany



Hörmann Alkmaar B.V., Netherlands



Hörmann Legnica Sp. z o.o., Poland



Hörmann Beijing, China



Hörmann Tianjin, China



Hörmann LLC, Montgomery IL, USA



Hörmann Flexon LLC, Burgettstown PA, USA



Shakti Hörmann Pvt. Ltd., India

Hörmann is the only manufacturer worldwide that offers you a complete range of all major building products from one source. We manufacture in highly-specialised factories using the latest production technologies. The close-meshed network of sales and service companies throughout Europe, and activities in the USA and Asia, make Hörmann your strong partner for first-class building products, offering "Quality without Compromise".

GARAGE DOORS
OPERATORS
INDUSTRIAL DOORS
LOADING EQUIPMENT
HINGED DOORS
DOOR FRAMES