

PRIMO | cubicle system





PRIMO | cubicle system



PRIMO – the movie. Please scan!

PRIMO – the exclusive solution for a smooth-surface construction with HPL composite elements. The clear design adds distinctive accents, especially in combination with the innovative saniQub partition wall.

In addition to the traditional version with floor clearance and limited cubicle height, PRIMO can also be designed in a floor-to-ceiling version in conjunction with brick-built walls and as an alternative to brickwork. Increasingly, architects are using this construction in their designs for visually attractive, highly-frequented sanitary facilities.

HPL surfaces are waterproof, exceptionally scratch and decay resistant, antibacterial and resistant to chemicals. Thanks to the specially developed composite construction, it is possible to use different colours on either side – PRIMO BiColor!

The system is available with two different types of element construction: PRIMO K with a thickness of 42 mm and PRIMO F with 30 mm. The inner frame in both versions assures resistance to warping as well as a long service life. The high quality is reflected

in the exceptional precision in terms of the inter-connection of the high-grade laminate and stainless steel elements. Electrical wiring, power sockets and sophisticated accessories can be integrated with ease into the wall panels. The fittings are perfectly adapted to one another and integrated into the extremely robust frame!

This innovative partition wall technology has been quality-checked in various tests and certified by the TÜV GS Technical Inspectorate! Design and technology *made by KEMMLIT* – the exclusive solution to satisfy even the highest demands.

PRIMO is suitable, for instance, for dual-entry changing cubicles, changing cubicles, cubicles for groups, therapy and treatment rooms, toilet and shower partitions.

PRIMO is used successfully in the following buildings: universities, museums, industrial and commercial premises, hospitals, nursing homes, spa and rehabilitation centres, swimming pools, sports and leisure facilities, camping and amusement parks, hotels, restaurants, administration and public buildings.

At a glance:

PRIMO – cubicle system	Page 3
PRIMO K – 42 mm composite elements	Page 5
PRIMO F – 30 mm composite elements	Page 7
PRIMO – room solutions	Page 8
PRIMO – profiles, fittings and legs	Page 10
PRIMO – furnishings	Page 12
PRIMO – accessories and engravings	Page 14
saniQub – partition system	Page 16
saniQub – options	Page 17
saniApps – partition system accessories	Page 18
saniQub – consumable supplies	Page 19
PRIMO – planning aid	Page 20
saniQub – planning aid	Page 21
PRIMO – colour scheme	Page 22
PRIMO – advice and planning in 3D	Page 23
KEMMLIT – ten good reasons	Page 23



PRIMO K | 42 mm composite elements

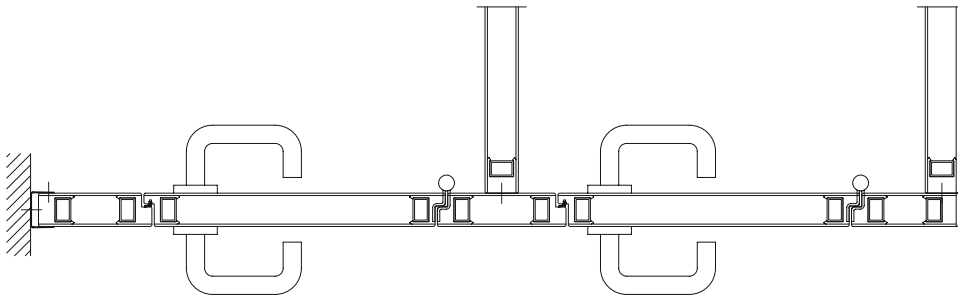

The walls of the PRIMO K cubicle system are made from 42 mm thick laminate composite elements with a solid plastic frame, which, for additional reinforcement, incorporates a 20 x 30 x 2 mm rectangular aluminium tube. The elements are bonded on both sides with 3 mm thick HPL solid core panels and on the inside with polyurethane rigid foam boards. Wiring for electrical connections can be routed invisibly inside the elements.

The rebated doors are of the same construction type as the walls, creating a flush front elevation. The doors are rebated-edged, incorporating a rubber strip as acoustic insulation.

The fittings consist of two robust stainless steel hinges, a solid double latch lock, and a handle (with red/white indicator in the escutcheon) made of stainless steel. Alternatively, the fittings can also be made from aluminium or nylon.

The leg construction is made entirely from stainless steel with a tread-resistant cover sleeve and is height adjustable. The stainless steel thread is 12 mm in diameter. The head rail above the front and on the side walls and the side U-profiles for equalizing dimensional tolerances are also made from high-grade stainless steel. Alternatively, the system can be fitted up to ceiling-height!

The PRIMO K cubicle system has been hygrothermally and mechanically quality-tested during the development phase – not just in our own laboratory tests, but by the 'Institute for Door Technology' in Rosenheim as well. The test results for damp/dry behaviour and behaviour when subjected to hard impacts (static/dynamic twisting) were "very good"!





PRIMO F | 30 mm composite elements

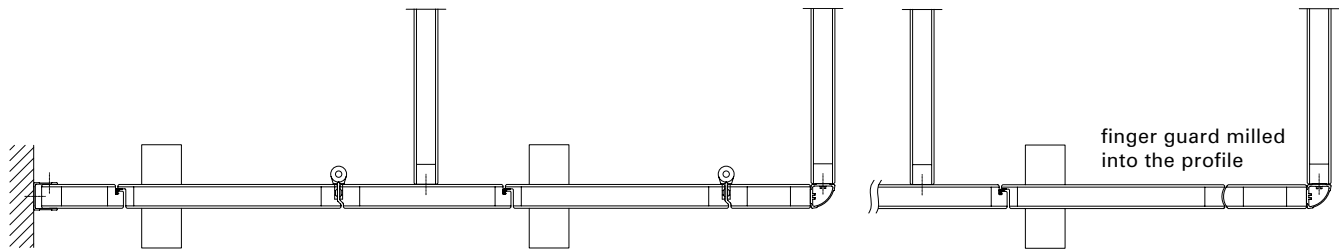

The PRIMO F cubicle system is smooth-surfaced and rebated. The door and wall elements consist of a 30 mm thick composite construction with a plastic frame running all the way round on the inside. Both sides are bonded with 3 mm thick HPL solid core panels.

A special protective layer on the HPL surface allows for enhanced scratch and abrasion resistance. This permits optimum maintenance and cleaning. The edges are elegantly rounded. The internal filling is made from polystyrene.

PRIMO F is ideally suited for wet and dry rooms. Wiring for electrical connections can be routed invisibly inside the elements.

Specifically to meet the high demands placed on PRIMO F, KEMMLIT has developed a three-roller edge hinge from aluminium with a 20 mm diameter hinge roll. It guarantees many years of wear-free functioning and, as an option, can be equipped with a spring hinge for automatic closing and opening of the door. As an alternative, the doors can be supplied with finger protection on the hinge side.

The door knobs on both sides are available in a choice of coloured nylon, anodised aluminium or stainless steel. The red/white indicator incorporates an emergency release to facilitate opening of the door in the event of an emergency. The closing mechanism consists of a single-latch WC lock.

The visible profiles are made from high-grade aluminium, which upon request can have either an anodised or colour powder-coated finish.



PRIMO | room solutions

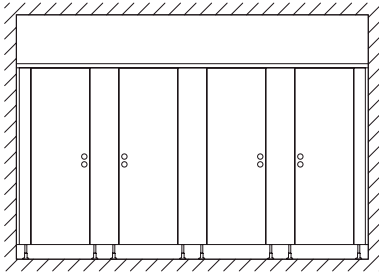

The PRIMO cubicle system with its two versions (type K and type F) features a traditional design with the legs in the front. As a rule, the floor clearance is 150 mm with an adjustment range of 80 to 215 mm. The legs are available in a choice of aluminium or stainless steel, and are firmly screwed on to the front elements using a M12 thread. The ideal system for highly frequented washrooms. In addition to being used as a toilet cubicle or changing room, the cubicle system is also ideally suited for changing cubicles at swimming baths.

PRIMO | support-optimised

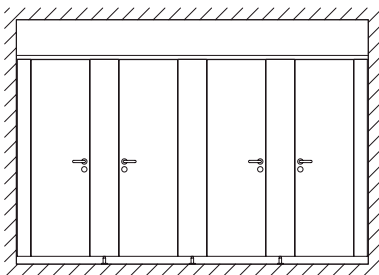

Support-optimised – this is the innovative PRIMO solution featuring legs integrated in the partitions. Invisible to the onlooker, visually perfect and easy to clean. As a special “front-suspended” version, it is also possible to set the head rail back upon request. The cubicle appears to “levitate” in the room and, as a result, creates a special visual effect.

PRIMO | suspended

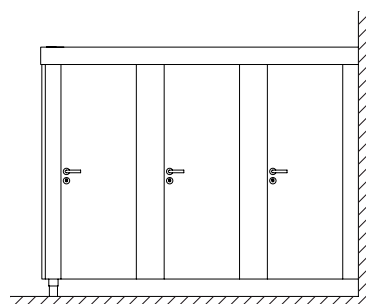

With the suspended solution, the carrier section is held by means of fastenings in the masonry or by floor supports, which dispense with the need for subsequently drilling holes in the floor. All the front walls are suspended on the carrier section and invisibly screw-connected. The aluminium carrier is firmly bolted to the masonry with heavy-duty plugs. When working with gypsum plasterboard walls, reinforcement inserts are additionally required on site. The floor supports are also firmly secured to the floor. The number of floor supports is determined by the span width. This technically sophisticated version is also frequently used for changing room cubicles in swimming baths.



PRIMO | floor-to-ceiling design

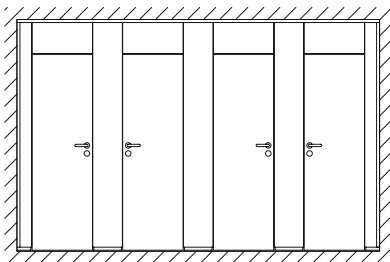

Doors, front panels and partitions are flush from the floor to the ceiling. This offers users optimum privacy. The front and the dividing partitions consist of continuous elements up to a height of max. 2500 mm. This makes this floor-to-ceiling version an extremely elegant, smooth-surfaced system with a perfect joint pattern!

PRIMO | with transom lights or upper panels

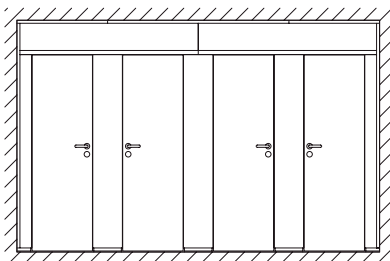

With this version of the floor-to-ceiling cubicle system, the doors, fronts and partitions are also flush to the ceiling and floor to ensure optimum privacy. Top panels from HPL composite elements or transom lights from real glass or perspex complete the front elevation. The wall elements are connected to the floor by means of a shadow gap profile. As an option, it is also possible to install grilles in the doors to permit adequate ventilation.

PRIMO | profiles, fittings, and legs

Amongst other things, trend-setting architecture is a question of technology. During the development stage, particular attention has been paid to details, furnishings, special solutions and joining elements.

High specification profiles, hinges, handles and legs on one side provide a unique design concept and a strong, durable and robust construction.



PRIMO K: Square head rail (60 x 30 mm) with wall rosette

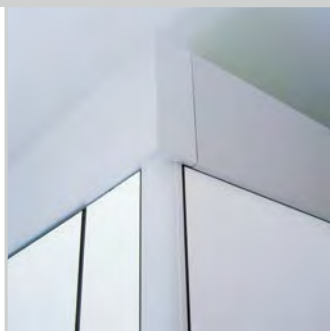

PRIMO F/K: Corner design for carriers for suspended system

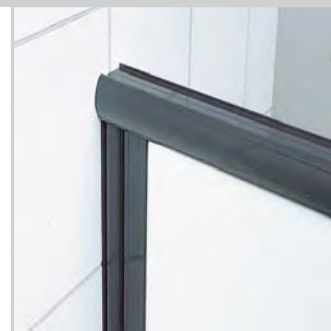

PRIMO F: Variable wall connection for angular wall



PRIMO F: Rounded head rail with wall rosette (55 x 43 mm), wall connection via U-channel profile



PRIMO F: Square head rail (42 x 43 mm), wall connection via U-channel profile



PRIMO F: Smooth-surfaced head rail (40 x 30 mm), wall connection via shadow gap profile



PRIMO F: Rounded corner design for rounded head rail



PRIMO F: Rounded-off corner design for square head rail



PRIMO F: Rounded-off corner design for flush head rail



PRIMO F: Maintenance-free, three-roller spring edge hinge from aluminium



PRIMO F: Maintenance-free, three-roller stainless steel hinge

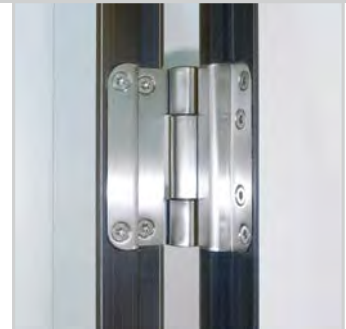

PRIMO K: Maintenance-free, three-roller stainless steel hinge



PRIMO F: Finger protection with pivot bearing milled into the profiles



PRIMO F/K: Height-adjustable leg from aluminium or stainless steel



PRIMO F/K: Leg in detail – with M12 thread and non-crush covering rosette



PRIMO F/K: Ergonomic knob fitting with red/white indicator



PRIMO F/K: Handle fitting made of stainless steel, aluminium or nylon



PRIMO F/K: Under-bench central locking with red/white indicator for changing room cubicles

PRIMO | furnishings and
complementary products

Customised, which means tailored to your precise needs. Combined with vanity units, locker systems, hairdryer stations and shelves from KEMMLIT.

Digital printed design to washroom areas gives an individual look. This includes high resolution pictures, symbols, logos or letters – nothing is impossible.



PRIMO F changing room with colored narrative or symbols



Cubicles with landscape scene printing



PRIMO F shower cubicles with individual design



Changing cubicles with under-bench central locking and bench seating combined with lockers.



Portholes (round/square), ventilation grilles, door seals, bottom scuff guards and other furnishings.



Custom-made doors, sliding doors, swing-doors, space-saving doors and disabled-accessible doors.



Treatment rooms with either a door or with curtains, vestibule partitions and other rooms solutions.



Space-saving and precisely-fitting corner cubicles in confined spaces and niches.



Urinal screens and sight screens in designs, materials and colours to match the cubicle system.



PRIMO | accessories and engravings



The cubicle and accessories create one system. Please bear this in mind when planning your room! KEMMLIT's exclusive range of accessories comprising the Alu Line, Elox Line and Value Line offers virtually unlimited scope for design in terms of materials, shapes, colours.

The range comprises toilet paper holders, brush sets, door stoppers, hooks, signages, shelves, waste bins and much more.

Installation of the accessories is provided by KEMMLIT.

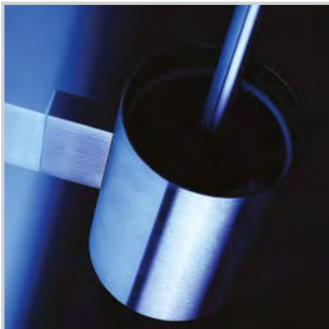

PRIMO cubicle systems have special wall reinforcements and integrated inserts in order to ensure long-lasting and vandal-proof fastening and utilisation of the accessories. You can find technical details on our range of accessories in our accessories brochure.

Specifically for HPL surfaces, it is also possible to have customised engravings for enhanced orientation and a perfect visual appearance!

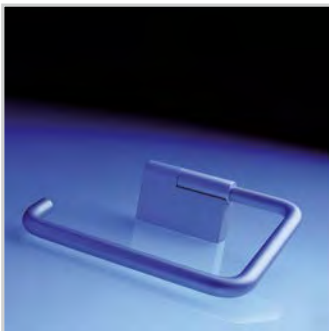

PRIMO can be complemented with the saniQub system wall. This partition can be used from either sides and is equipped with high specification accessories, which are smoothly integrated in the system wall.

Other items such as room perfumes and mirrors can be used to contribute to the overall ambiance.

saniQub®



saniQub – the movie. Please scan!

saniQub® | in combination with the cubicle system PRIMO

With the new saniQub partition system KEMMLIT provides much more than separation in the washroom. In combination with the PRIMO F cubicle system, KEMMLIT creates a tailored solution, which not only ensures a harmonizing overall appearance with integrated saniApps accessories, but also eliminates subsequent installation of separate accessories. saniQub creates an ambiance of wellness in your washrooms.

Awarded with the Plus X Award 2013



Awarded with the Plus X Award 2013, the Iconic Award 2013 and the German Design Award (Special Mention) 2014.



The dividing wall, 156 mm in depth, is surfaced with 3 mm HPL panels with the interior made of polystyrene. If required accessories can be installed on both sides. The partition system, featuring a solid aluminium frame, is pre-assembled, delivered and installed with exceptional precision according to the individual requirements of each customer.

It is easily operated from both sides, if desired. The design utilizes the entire depth of the dividing wall for the factory installed saniApps. These are manufactured entirely from stainless steel and feature a matte surface finish, providing innovative functions and a timeless design.



Wall connections to partial height sanitary blocks (boxing) are carried out via infill panels. All other wall connections are carried out via shadow gap profiles.

During planning stages the partition system can be customized for either male or female facilities. This is achieved by the choice of saniApps and can be further emphasized by the selected color scheme. saniQub is available in the PRIMO color range according to the color chart – special colors are available upon request. Design and function in one – the saniQub partition system sets a new visual and functional benchmark for public washroom facilities!



Our performance – Your advantages:

- Partition systems with optional comfort features
- Integrated accessories for male or female facilities
- Custom-made and space-saving, fitting any room setting
- Precise industrial production process
- Reduces construction time
- Timeless design with high quality materials and innovative functions
- Ready-for-use solution for public washroom facilities
- Consultation, production and installation – all from one single source

With an extensive choice of accessories saniQub provides the opportunity for the specifier to customize the partition system and adapt to any individual situation. The variety of accessories ranges from dispensers to air fresheners, with each element uniformly integrated into the dividing wall according to a raster system.

All accessories are flush and within a incorporated grid to meet individual preferences. The depth of the dividing wall is between 1250 mm – 1600 mm with under panel clearance from 80 mm – 180 mm and the cubicle height from 2000 mm – 2135 mm. The integrated accessories are chosen and located according to the requirements of the customer. Your local KEMMLIT sales representative will provide you with a detailed 3D illustration and views of the saniApp layout.



Planning options:

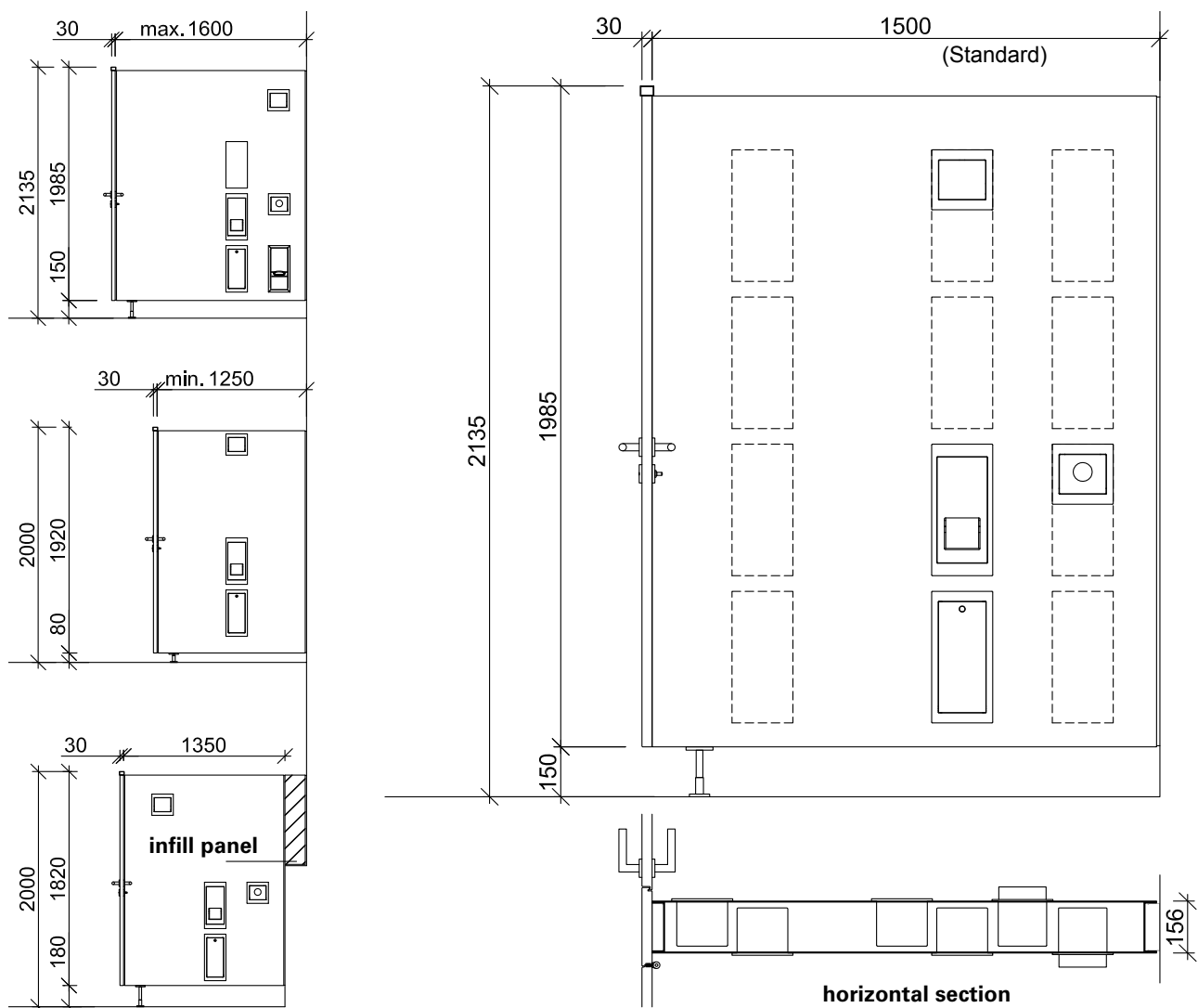



saniApps® | partition system accessories

The saniQub partition system can be equipped with saniApps, the exclusive range of high quality accessories, providing functional design solutions uniformly integrated into the dividing wall. The saniApps, made entirely of brushed stainless steel, range from standard equipment such as brush sets or toilet paper holders to stainless steel mirrors and air fresheners offering practical design and a stylish appearance.



saniApp waste bin
(approx. 5 liters holding capacity)



saniApp brush set



saniApp toilet paper holder



saniApp sanitary bag dispenser with magnetic locks



saniApp air freshener with magnetic locks



saniApp stainless steel mirror in different sizes



saniApp door stopper hook



saniApp wall hook for toilet paper rolls or clothes



saniQub® | consumable supplies

The convenient KEMMLIT accessories for public washroom facilities can easily be purchased through the KEMMLIT onlineshop – toilet tissues, brush sets, hygienic bags or room perfumes. It is also possible to use standard products and accessories.

The KEMMLIT online shop which is recognized by leading retailers provides security and offers choices for payment including PayPal. Shipment is usually done by our partner DHL, so a prompt and safe delivery is ensured. More on shop.kemmlit.de



Brushes and brush sets



Toilet paper



Hygienic bags



Room perfumes



Waste bags



Magnetic key



	PRIMO F		PRIMO K	
Quality mark:	TÜV certified and GS tested		TÜV certified and GS tested	
	Standard	Optional	Standard	Optional
Walls and doors:	30 mm HPL composite construction		42 mm HPL composite construction	
System height:	2000/2135 mm	other heights possible	2000/2135 mm	other heights possible
Cubicle depth:	up to 1600 mm without joint (standard 1500 mm)		up to 1600 mm without joint (standard 1500 mm)	
Door height:	max. 2100 mm		max. 2100 mm	
Door width:	570 – 980 mm (standard 650 mm)		570 – 980 mm (standard 650 mm)	
Front panels height:	max. 2445 mm without joint		max. 2445 mm without joint	
Floor clearance:	150 mm	80 – 215 mm; without floor clearance with 40 mm plinth	150 mm	80 – 215 mm; without floor clearance with 2 mm plinth
Top panels:	max. 1800 x 650 mm; with continuous front panel, top panel fitted above door		max. 1800 x 650 mm; with continuous front panel, top panel fitted above door	
Transom light:	max. 1800 x 650 mm		max. 1800 x 650 mm	
Suspended system:	carrier 50/150 mm	carrier 50/200 mm	carrier 50/150 mm	carrier 50/200 mm
Changing cubicles:	standing	suspended	standing	suspended
Wall connection:	U-channel profile	shadow gap profile	U-channel profile	shadow gap profile
Corner connection:	corner post flush-mounted		without profile with decorative edge	
Cubicle joint:	tongue and groove (milled)	H-profile; shadow gap profile	rebated	tongue and groove (milled)
Head rails from aluminium:	55/43 mm	42/43 mm; 30/44 mm	60/30 mm	
Head rails from stainless steel:	40/30 mm	30/40 mm	60/30 mm	40/30 mm
Hinges from aluminium:	3-roller spring edge hinge	3-roller spring edge hinge	–	–
Hinges from stainless steel:	3-roller spring edge hinge	3-roller spring edge hinge	3-roller spring edge hinge	–
Finger protection:	journal bearing with milling	–	–	–
Knob:	single-latch WC knob from nylon	single-latch WC knob; single-latch profile cylinder knob; knob without WC lock; push handle; touch plate; from nylon, aluminium or stainless steel	–	–
Handle:	–	double-latch WC handle; double-latch profile cylinder handle; handle only; from nylon, aluminium or stainless steel	double-latch WC handle from stainless steel	double-latch WC handle; double-latch profile cylinder handle; handle only; push handle; touch plate; from nylon, aluminium or stainless steel
Legs:	aluminium	stainless steel	stainless steel	aluminium
Cut-outs for light:	porthole, round rebated Ø 300	other cut-outs possible	porthole, round rebated Ø 300	other cut-outs possible
Mechanical door closer:	door closer with slide rail	–	door closer with slide rail	–
Empty conduit system for electrics:	upon request		upon request	
accessories/special inserts:	Special inserts in the walls for accessories, shelves, bench seating, etc.; individually planned and installed		Special inserts in the walls for accessories, shelves, bench seating, etc.; individually planned and installed	
Modesty screen:	30 mm HPL-sandwich (dimensions: 825 x 435 mm)	special sizes available	30 mm HPL-sandwich (dimensions: 825 x 435 mm)	special sizes available

saniQub partition system:

Layout / use	As dividing panel in combination with the cubicle system PRIMO; not available as a front panel with doors
Cubicle depth	Standard 1500 mm, min. 1250 mm, max. 1600 mm
System height	2000 – 2135 mm, other heights possible
Wall elements	156 mm thick composite construction with 3 mm thick HPL (high pressure laminate) solid core panels, internal packing made from polystyrene, aluminium frame
Legs	Aluminium legs, satin anodised, 80 – 180 mm under panel clearance and aluminium WC cover sleeve
Wall connection, without sanitary block	Via shadow gap profile made of satin anodised aluminium, 10 mm joint
Wall connection, with sanitary block	Via infill panel and shadow gap
Construction	Support-optimized system, legs recessed, head rail above door front, recessed rail possible
Modesty screens	Upon request

saniApps accessories:

Double toilet paper holder	Brushed stainless steel, dimensions: 395 x 180 mm, compatible with KEMMLIT longlife toilet paper rolls (900 sheets per roll), integrated replacement roll, also suitable for standard toilet paper rolls, magnetic lock included, optional also with conventional cam lock.
Waste bin	Brushed stainless steel with knob for easy handling, holding capacity approx. 5 liters, dimensions: 395 x 180 mm,
Brush set	Brushed stainless steel, dimensions: 395 x 180 mm, applicable for WC brushes with a 8.5 cm brush head diameter
Sanitary bag dispenser	Brushed stainless steel, magnetic opener (without lock), box for sanitary bags with round opening, dimensions: 180 x 180 mm
Air freshener	Brushed stainless steel, with magnetic lock, scent is released through vent holes on top when cubicle door is operated, dimensions: 180 x 180 mm
Stainless steel mirror (option SS1)	stainless steel with mirror polish, dimensions: 395 x 180 mm
Stainless steel mirror (option SS2)	stainless steel with mirror polish, dimensions: 830 x 180 mm
Door stopper hook	Brushed stainless steel surface, length: 105 mm, cover sleeve diameter 60 mm, hook diameter 15 mm

Supplies for saniQub:

Available via the KEMMLIT Onlineshop at shop.kemmlit.de

WC brush	Replacement brush with brushed stainless steel handle and black, removable brush head, length: 38 cm, diameter of head 8.5 cm
WC brush head	High quality replacement brush head without handle, set of 3, diameter of brush head 8.5 cm, incl. M12 screw thread, depth: approx.. 40 mm, color: black
WC toilet paper	KEMMLIT longlife toilet paper, 900 sheets per roll, 2 ply, extra absorbent, ultra soft, length of rolls 112,5 m, width of roll 10 cm, come in packages of 36 rolls Optional: standard toilet paper , 250 sheets per roll, 2 ply, made of 100 % recyclable material, minted, perforated, length of roll 30 m, width of roll 9.7 cm, 8 x 8 rolls per package
Sanitary bags	Sanitary bags refill pack, bags made of polyethylene, colour: white, dimensions: 87 x 127 x 19 mm, thickness of foil 15 µ, pack of 30 folded bags per dispenser, 25 dispensers per box
Air freshener options	Granulate in special permeable bags/ gel in different fragrances, automatically released through motion sensor
Waste bags	Holding capacity 10 liters, made of HDPE, transparent, 320 x 440 mm, 50 bags per roll, 24 rolls per package
Magnetic lock opener	Replacement magnetic opener for easy handling of saniApp magnetic locks

PRIMO | colour scheme

The choice of colours is virtually endless! Colours and surfaces are perfectly coordinated to match the cubicle systems and other sanitary products from KEMMLIT. Thanks to the composite construction, walls and doors can have different colours on either side – PRIMO BiColor. The same colour concept can be used for the partition wall saniQub. Special colours and customised digital prints are possible upon request at any time.

Panels and doors:



crystal white **9108**

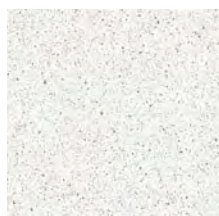

granite white **9108P**

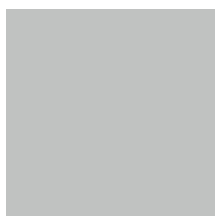

light grey **7208**



quartz grey **7708**



graphite **7808**



sahara yellow **1608**



corn yellow **1708**



candy orange **2208**



tornado red **3508**



garnet red **3708**



royal blue **5808**

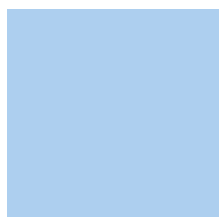

lagoon blue **5408**

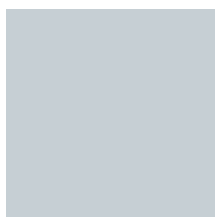

silver **7408**

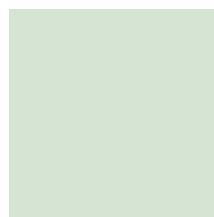

glacier green **6608**



emerald green **6208**

Profiles, hinges, furniture, supporting legs and accessories:



white
02



manhattan
05



anthracite
03



dark blue
04



red
11



dark red
01



yellow
10

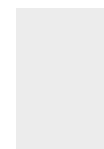

satin
anodised **08**



stainless
steel V2A **12**

The colours illustrated apply exclusively to products from KEMMLIT® PRIMO and, for technical printing reasons, may differ slightly from the actual colours. Further information is available at www.kemmlit.com.

PRIMO | advice and planning in 3D

As an ideal complement to personal advice provided on site, KEMMLIT also offers a rapid, true-to-scale and three-dimensional sanitary planning service for rooms and products, which highlights specific product details and in doing so ensures reliable planning.

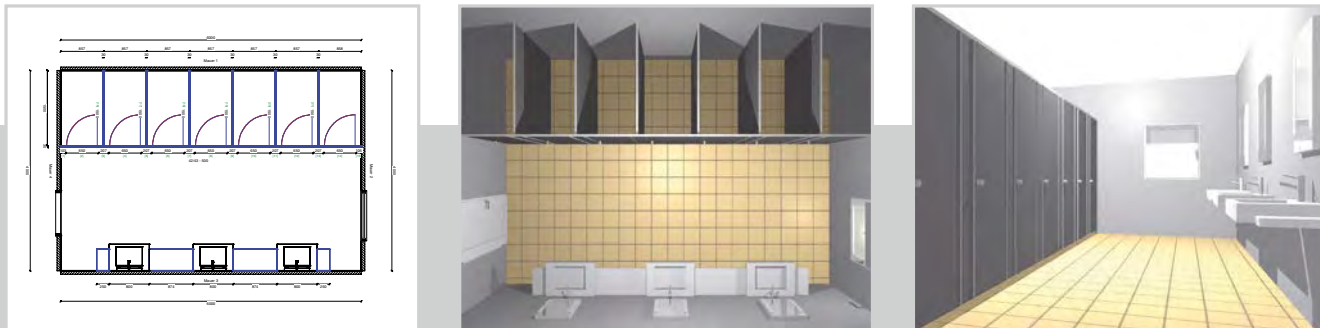

By consulting an expert adviser from KEMMLIT, washrooms can be designed to meet customers' precise requests and requirements. Thanks to our professional and customised planning service, an amazingly realistic impression of your design is gained in advance.

KEMMLIT supports your project from the initial idea through to the completed installation on site irrespective of project scope.

KEMMLIT® | ten good reasons

1. 125 years of experience and market leadership
2. Extensive product range
3. Product innovation with top design
4. Top quality in terms of material and processing
5. Harmonising solutions
6. Individual consulting service by professional sales representatives
7. Quick quotation processing
8. Prompt and on-schedule delivery
9. Professional installation on site
10. One-stop service



Further information:



www.kemmlit.com

**Individual
sanitary fittings
by KEMMLIT®**

For example:

Changing cubicles
Toilet cubicles
Shower cubicles
Locker systems
Vanity units
Shelving
Bench seating
Baby changing stations
Accessories

Kemmlit UK

Bays Platt, Skirmett,
Henley-on-Thames,
Oxfordshire RG9 6TD
United Kingdom

Tel: +44(0)1491 638606
Fax: +44(0)1491 638072
www.kemmlituk.com
info@kemmlituk.com

