

Performance-proven fastening
for Rainscreen and Facade Systems

Includes Light Steel Framing

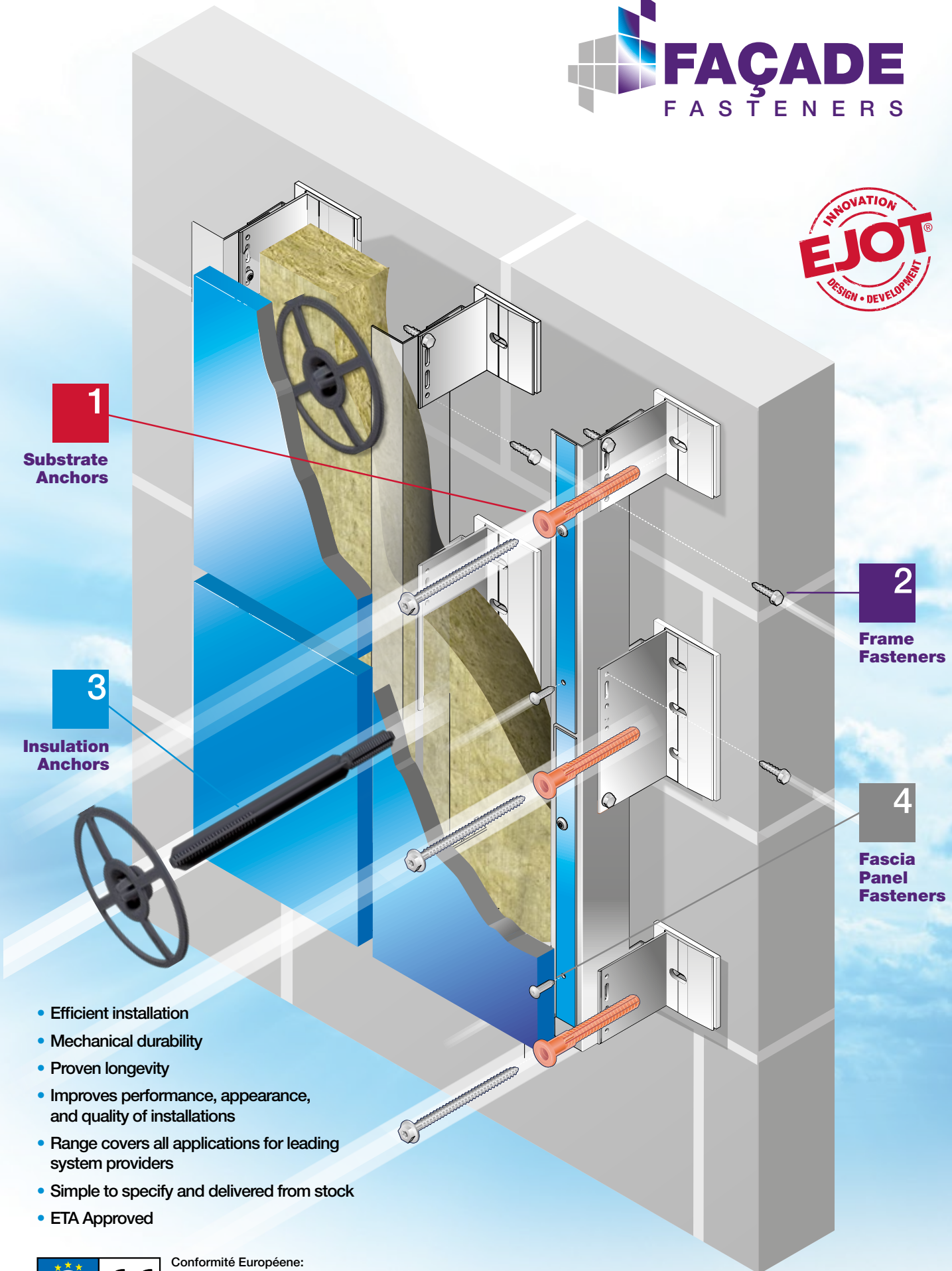



1
Substrate Anchors

3
Insulation Anchors

2
Frame Fasteners

4
Fascia Panel Fasteners

- Efficient installation
- Mechanical durability
- Proven longevity
- Improves performance, appearance, and quality of installations
- Range covers all applications for leading system providers
- Simple to specify and delivered from stock
- ETA Approved



Conformité Européenne:
European Conformity
The CE mark demands an annual audit of the factory production control and product quality assurance.

Contents



NFRC
LEADING ROOFING EXCELLENCE

CONSTRUCTION FIXINGS
association
FULL MANUFACTURING MEMBER

PERFORMANCE-PROVEN FASTENING SYSTEM4

EJOT TECHNICAL SUPPORT

On-site6

Off-site7

1 - SUBSTRATE FASTENERS8

Support structure to concrete & masonry..... 9-11

Support structure to steel framing..... 11-13

Support structure to OSB & Ply and to timber structures including CLT (cross laminated timber).....13

2 - SUPPORT FRAME FASTENERS.....14

Aluminium frame assembly..... 15-16

3 - INSULATION FASTENING.....17

Insulation to concrete and masonry18

Insulation through sheathing boards to light steel frame 19-21

4 - EXTERIOR FACADE PANEL / SYSTEM FASTENING.....22

Timber cladding to timber23

Pierce point fastener for clip secured façade systems23

Powder coated RAL colour options 23-26

5 - ACCESSORIES, DRIVE BITS AND DRILL BITS.....27

6 - BACKING STRUCTURE FRAMING FASTENERS.....28

Base / head channel to concrete 29-31

Head and base track to stud and stud to stud 31-32

Sheathing board to steel frame 32-33

Sheathing boards to aluminium.....33

Sheathing boards to timber frame34

EJOT THE COMPLETE SOLUTION FOR THE MODERN BUILDING ENVELOPE35

Cover image courtesy of Speedclad Ltd:
Integrated natural stone rainscreen cladding,
curtain walling and glazing at Wellington Place,
Leeds. Main Contractor: Wates Construction.

Performance-proven fastening system

EJOT Rainscreen fastening systems provide efficient installation and mechanical durability for fixing rainscreens, building envelopes and rear ventilated façades.

EJOT manufactures products designed to improve performance, appearance, and quality of installations providing the solutions for all the applications, for all the leading system providers. And all from one internationally proven manufacturer.



The engineered concept

EJOT provides the complete package of products for the four key application areas of rainscreen installation.

EJOT's range is second to none. With many years of development experience, EJOT understands the requirements of fasteners and their applications on building envelopes.



Performance and longevity

A reputation for high-performance and value has positioned EJOT as the manufacturer of choice for partnerships in fastening technology, across a whole spectrum of engineering disciplines. Performance and longevity are secure and proven.

All applications secured

EJOT's range of masonry and insulation anchors are widely acknowledged as the best available and are market leaders. EJOT's expertise and product development program sits behind our frame fasteners and fascia panel fasteners, ensuring a technical advantage, durability and a secure 'mechanical' fixing.

Quick efficient installation

Installation typically accounts for up to 30% of the total cost of a rainscreen façade, therefore quick and efficient installation is imperative. The selection of the right fasteners is critical for correct and safe assembly. The paramount factor of any façade installation is safety; and EJOT's use of high grade materials, which result in minimal electrostatic oxidation and corrosion, ensure that structural longevity is assured.



Simple to specify, delivery from stock

The EJOT UK website is a technical resource in its own right, providing specifiers with an easy route to product detail, data sheets, application guides and technical compliance information.

Buy online and save time

The EJOT Webshop has been steadily expanded to provide an extensive shop window that completely mirrors traditional purchasing processes, with in excess of 3000 fastening products and variants available electronically. And that figure continues to grow.

Navigating levels of technical information has been carefully addressed with many applied 'product-finder' filters that lead customers from application to substrate, with all other relevant specification criteria in between.

Registration to the EJOT webshop is straightforward and leads to a personalised online pricing structure, flexible purchasing and a quick link reference to your order history.



**For easy and efficient ordering online
go to www.ejot.co.uk**

Scan the QR code with your mobile device to go directly to **My EJOT**.

EJOT technical support on-site

When specifying outside of any standard technical parameters our technical team may recommend a thorough test report, carried out on site by a qualified EJOT engineer.

The reason is straightforward. Whilst we can be 100% sure of the technical performance that is engineered into EJOT products, no one can second guess for example, the integrity of substrates. Where high loadings into critical structural areas create potential risk, we want our customers to have absolute peace of mind and confidence in the match between fixing and substrate - and the correct installation process.

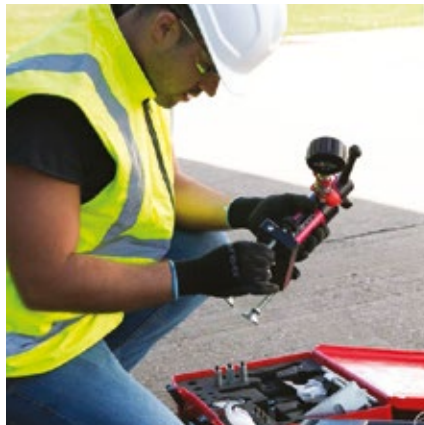

Much more than 'added value'

Whether it is ourselves instigating the survey, the installer, contractor or structural engineer, our technical team will gather information in advance by issuing a short but concise form to ensure our engineer is fully briefed.

With site-induction cleared, the testing process will follow set procedures that have been developed by EJOT's technical teams globally. That means our engineers are briefed on product, substrate, and the impact of climate and environmental conditions.

Our engineers then compile a documented report. This data provides a mean-average conclusion that will enable any structural engineer to compare loadings against the necessary European Technical Approval specifications.

Typical site test process

- **Identification**
EJOT's technical support team will assess the product application specification
- **Recommendation**
This may require an on-site test survey. Alternatively, anyone in the specification to installation chain may make this request
- **Information**
Our technical team will issue a 'site test requisition form' in advance
- **Survey**
Multiple points at varying heights across the structure, tested to point of substrate failure
- **Results**
Compiled and data documented for assessment by the Structural Engineer

EJOT technical support off-site

EJOT APPLITEC is at the heart of our operations worldwide; the design, origination, testing and manufacturing of progressive fastening systems that provide high installation performance and longevity in application.

Here in the UK, our APPLITEC Centre has become an industry-wide resource, often in partnership with leading OEMs, sharing an holistic objective to develop better, more efficient products for the modern building envelope.



Solving on-site challenges with off-site technology

When customers need support with technical issues on-site, Applitec technicians are able to replicate conditions off-site - providing a resource of immeasurable value.

There are many scenarios where our team can define or resolve a specific issue, typically installation omissions or substrate inconsistencies. Our laboratory is equipped with state-of-the-art equipment, and the technical ability to test virtually any scenario, during or prior to installation.



Testing reports compiled by Applitec technicians can enable structural engineers to determine if an incorrect installation is still fit for purpose. Equally, where there are any doubts surrounding substrates, test conditions can be created as a means of forecasting performance.

1

Substrate fasteners

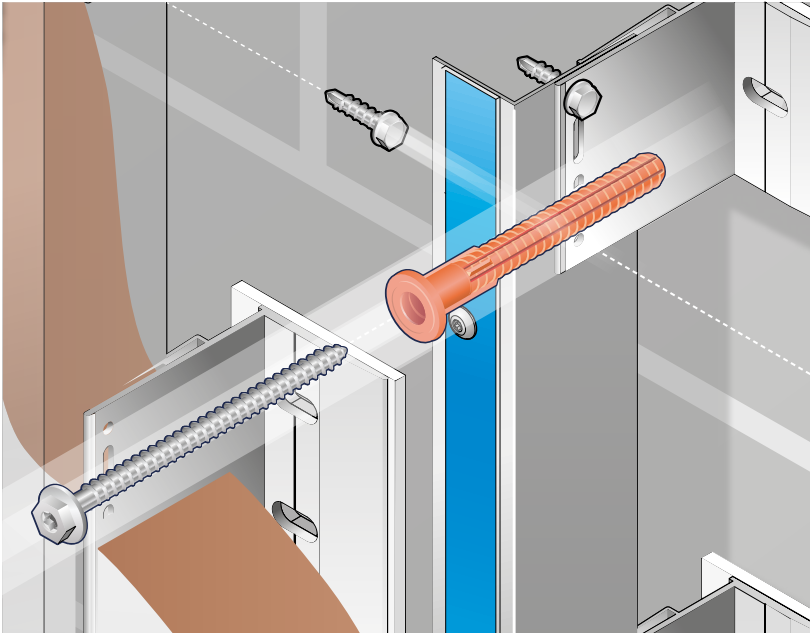

Support structure to concrete & masonry

Support structure to steel framing

Support structure to OSB & Ply and to timber structures including CLT (cross laminated timber)

The performance of any rainscreen system relies on its attachment to the backing structure, ranging from timber and CLT to metal stud and composite panel systems.

To meet the variations and demands of masonry and concrete, we offer rainscreen designers and engineers the highest standard ETA compliant anchors and chemical anchoring systems with accredited data for known substrates, backed up by our onsite testing service.

EJOT fastener systems are suitable for steel or aluminium support sections and stainless steel or aluminium helping hand and bracketry systems providing solutions for every eventuality.

For product information and technical support, please call **Support team 01977 687040** or visit **EJOT UK online**



Find the right fasteners and anchors for your façades application

EJOT UK has developed a Rainscreen fasteners specifier app, available for iOS and Android devices - FREE to download.



Support structure to concrete and masonry

SDF-KB 10V x Length E

Screw-set Anchor

Application

Installing helping hand brackets and metal sections to concrete and masonry.



ETA 10/0305



Material A4 Stainless Steel with nylon plug

Fixing

Lengths	50, 60, 70mm
Min Embedment Concrete	40mm
Min Embedment Masonry	50mm
Hole Diameter	ø 10mm

13mm Hex one piece socket or T40 Drive

SDF-KB 10H x Length E

Screw-set Anchor

Application

Installing helping hand brackets and metal sections to perforated brickwork and masonry.



ETA 10/0305



Material A4 Stainless Steel with nylon plug

Fixing

Lengths	80 to 220mm
Min Embedment	70mm
Hole Diameter	ø 10mm

13mm Hex one piece socket or T40 Drive

SDP-KB 10G x Length E

Screw-set Anchor

Application

Installing helping hand brackets and metal sections to aerated concrete.



ETA 012/0502



Material A4 Stainless Steel with nylon plug

Fixing

Lengths	80 to 220mm
Min Embedment	70mm
Hole Diameter	ø 10mm

13mm Hex one piece socket or T40 Drive

BA-E 8 Range

Anchor Bolt

Application

Installing helping hand brackets and metal sections to dense concrete.



ETA 14/0219



Material A4 Stainless Steel, A4 Stainless Steel HCR

Fixing

Lengths	72 to 147mm
Min Embedment	45mm
Effective Clamping Thickness	10 to 85mm
Bolt Diameter	ø 8mm

13mm socket

Support structure to concrete and masonry

BA-E 10 Range

Anchor Bolt

Application

Installing helping hand brackets and metal sections to dense concrete.



ETA 14/0219



Material A4 Stainless Steel, A4 Stainless Steel HCR

Fixing

Lengths	92 to 132mm
Min Embedment	60mm
Effective Clamping Thickness	10 to 50mm
Bolt Diameter	ø 10mm

17mm socket

BA-E 8 Plus Range

Anchor Bolt

Application

Installing helping hand brackets and metal sections to dense concrete.



ETA 18/0219



Material A4 Stainless Steel

Fixing

Lengths	75 to 150mm
Min Embedment	48mm
Effective Clamping Thickness	10 to 85mm
Bolt Diameter	ø 8mm

13mm socket

BA-E 10 Plus Range

Anchor Bolt

Application

Installing helping hand brackets and metal sections to dense concrete.



ETA 18/0219



Material A4 Stainless Steel

Fixing

Lengths	72 to 162mm
Min Embedment	40mm
Effective Clamping Thickness	10mm to 100mm
Bolt Diameter	ø 10mm

17mm socket

Chemical Resin & Stud M8

Multifix VSF Chemical Anchoring System

Application

Installing helping hand brackets and metal sections to Concrete (cracked & uncracked) brick, block & perforated brick.



ETA 13/0918



Material Multix VSF: Styrene-free, low-odour 'high reactivity' vinylester resin.
Stud M8: Available in BZP finish or A4 Stainless Steel.

Fixing

Standard Embedment Range	80 - 125mm
Torque Range	10 - 140Nm
Drill Diameter	ø 10mm

Support structure to concrete and masonry

Chemical Resin & Stud M10

Multifix VSF Chemical Anchoring System

Application

Installing helping hand brackets and metal sections to Concrete (cracked & uncracked) brick, block & perforated brick.



ETA 13/0918



Material Multifix VSF: Styrene-free, low-odour 'high reactivity' vinylester resin.
Stud M10: Available in BZP finish or A4 Stainless Steel.

Fixing

Standard Embedment Range	80 - 125mm
Torque Range	10 - 140Nm
Drill Diameter	ø 12mm

Support structure to steel framing

JT3-3-6.3 x Length

Bi-met Self-drilling Fastener

Application

Installing helping hand brackets and metal sections to Steel Framing 1.2mm to 3.0mm in thickness.



Material A2 Austenitic Stainless Steel with Carbon Steel drill point

Fixing

Lengths	38, 50mm
Washer option	S16

8mm Clip hex one piece socket

JT3-3-5.5 x Length

Bi-met Self-drilling Fastener

Application

Installing metal sections to Steel Framing 1.2mm to 3.0mm in thickness.



Material A2 Austenitic Stainless Steel with Carbon Steel drill point

Fixing

Lengths	35, 50mm
Washer option	S16

8mm Clip hex one piece socket



ETA 10/0200

JT3-X-2-6.0 x Length

Bi-met Self-drilling Fastener

Application

Installing helping hand brackets and metal sections to Steel Framing 0.9mm to 1.6mm in thickness.



Material A2 Austenitic Stainless Steel with Carbon Steel drill point

Fixing

Lengths	36, 46mm
Washer option	36mm

8mm Clip hex one piece socket

Support structure to steel framing

JT3-6-5.5 x Length

Bi-met Self-drilling Fastener

Application

Installing helping hand brackets and metal sections to Steel Framing 1.2mm to 6.0mm in thickness.



ETA 10/0200



Material A2 Austenitic Stainless Steel with Carbon Steel drill point

Fixing

Lengths 25, 30, 50mm

Washer option S16

8mm Clip hex one piece socket

JT3-12-5.5 x Length

Bi-met Self-drilling Fastener

Application

Installing helping hand brackets and metal sections to Steel Framing 4.0mm to 12.0mm in thickness.



ETA 13/0177



Material A2 Austenitic Stainless Steel with Carbon Steel drill point

Fixing

Lengths 40, 67mm

Washer option S16

8mm Clip hex one piece socket

JT3-18-5.5 x Length

Bi-met Self-drilling Fastener

Application

Installing helping hand brackets and metal sections to Steel Framing 4.0mm to 18.0mm in thickness.



ETA 13/0177



Material A2 Austenitic Stainless Steel with Carbon Steel drill point

Fixing

Lengths 55, 115mm

Washer option S16

8mm Clip hex one piece socket

JT6-6-5.5 x Length

Bi-met Self-drilling Fastener

Application

Installing helping hand brackets and metal sections to Steel framing from 1.2 to 6.0mm in thickness.



ETA 13/0177



Material A4 Austenitic Stainless Steel with Carbon Steel drill point

Fixing

Lengths 25, 35mm

Washer option S16

8mm Clip hex one piece socket

Support structure to steel framing

JT6-12-5.5 x Length

Bi-met Self-drilling Fastener

Application

Installing helping hand brackets and metal sections to Steel framing from 4.0 to 12.0mm in thickness.



Material A4 Austenitic Stainless Steel with Carbon Steel drill point

Fixing

Length 40mm
Washer option S16

 8mm Clip hex one piece socket



ETA 13/0177

Support structure to OSB & Ply and to timber structures including CLT (cross laminated timber)

JA3-6.5 x Length

Stainless Steel Self-tapping Fastener

Application

Installing helping hand brackets and metal sections to OSB & PLY and to timber structures including CLT (cross laminated timber).



Material A2 Austenitic Stainless Steel

Fixing

Lengths 50, 64, 75mm
Washer option S16

 8mm Clip hex one piece socket



ETA 13/0177

JT3-2-6.5 x Length

Bi-met Self-drilling Fastener

Application

Installing helping hand brackets and metal sections to OSB & PLY and to timber structures including CLT (cross laminated timber).



Material A2 Austenitic Stainless Steel with Carbon Steel drill point

Fixing

Lengths 50, 65, 80mm
Washer option S16

 8mm Clip hex one piece socket



ETA 13/0177

JT4-2-5.6 x 70

Stainless Steel Self-drilling Fastener

Application

Installing helping hand brackets and metal sections to OSB & PLY and to timber structures including CLT (cross laminated timber).



Material A2 Austenitic Stainless Steel

Fixing

Length 70mm
Washer option S16

 8mm Clip hex one piece socket

2

Support frame fasteners

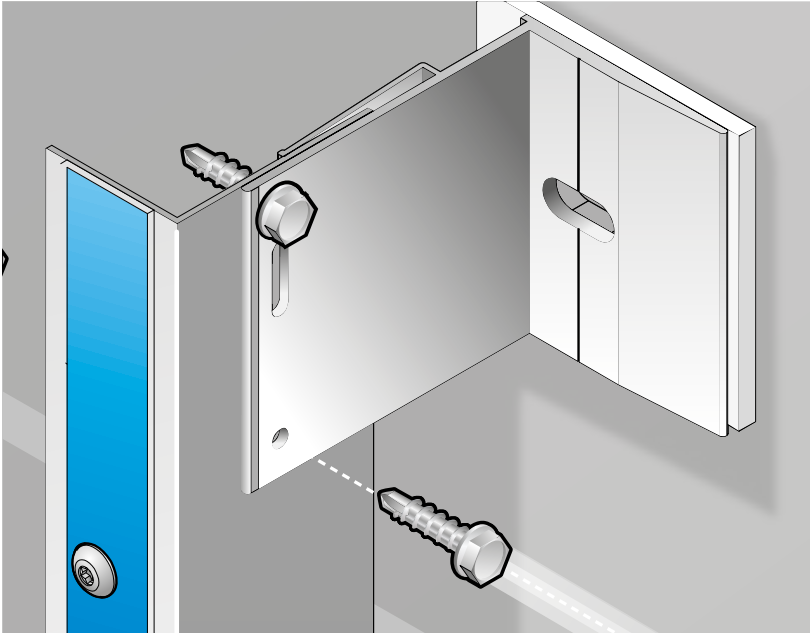

Aluminium frame assembly

Stainless Steel self-drilling fasteners

Bi-metal self-drilling fasteners with carbon steel drill point

Vario screw - fixed and floating point single fastening

From timber, steel, aluminium and stainless steel, the simplistic to the most complex support framing systems and materials require a complete range of fastener solutions. EJOT's innovative Vario range adds depth to the fastener choices we already provide. Its engineered design minimises stripping whilst controlling compression and clamping of the sections, allowing for both floating and fixed point scenarios to provide consistent installation and guaranteed mechanical performance.

For product information and technical support, please call **Support team 01977 687040** or visit **EJOT UK online**



Find the right fasteners and anchors for your façades application

EJOT UK has developed a Rainscreen fasteners specifier app, available for iOS and Android devices - FREE to download.



Aluminium frame assembly

JT4-4-4.8 x 19

Stainless Steel Self-drilling Fastener

Application

Aluminium to aluminium section 1.5 to 4.0mm thickness.



ETA 10/0200

Material A2 Austenitic Stainless Steel

Fixing

Length	19mm
Washer option	S14

 8mm Clip hex one piece socket

JT4-ZT-4-4.8 x Length

Stainless Steel Self-drilling Fastener

Application

Aluminium to aluminium section 1.5 to 4.0mm thickness.



Material A2 Austenitic Stainless Steel

Fixing

Lengths	19, 25mm
Washer option	Unwashed

 T25 Drive

JT4-FR-4-4.8 x 19

Stainless Steel Self-drilling Fastener

Application

Aluminium to aluminium section 1.5 to 4.0mm thickness.



Material A2 Austenitic Stainless Steel

Fixing

Length	19mm
Washer option	S12

 T25 Drive

JT4-FR-4-5.5 x 19

Stainless Steel Self-drilling Fastener

Application

Aluminium to aluminium section 1.5 to 4.0mm thickness.



Material A2 Austenitic Stainless Steel

Fixing

Length	19mm
Washer option	S12

 T25 Drive

Aluminium frame assembly

JT4-6-5.5 x Length

Stainless Steel Self-drilling Fastener

Application

Aluminium to aluminium section 1.5 to 6.0mm thickness.



ETA 10/0200

Material A2 Austenitic Stainless Steel

Fixing

Lengths	19, 22mm
Washer option	A15

 **8mm Clip hex one piece socket**

JT6-2/5-5.0 x 30 E14-Vario

Bi-met Self-drilling Fastener

Application

Aluminium to aluminium section 2.0 to 3.0mm thickness. To form sliding and fixed points on sub-structure. Fastening pre-punched stainless steel or aluminium helping hand brackets to aluminium support profiles. Pre-assembled captive sliding washer. Buffer zone between the screw head and sliding washer prevents excessive clamp load to the joint.



Material A4 Austenitic Stainless Steel with Carbon Steel drill point

Fixing

Length	30mm
Washer option	E14

 **EJOT® A/F 8 VARIO Tool**

JT9-2/5-5,0 x 25 E14 Vario

Stainless Steel Self-drilling Fastener

Application

Aluminium to aluminium section 2.0 to 3.0mm thickness. To form sliding and fixed points on sub-structure. Fastening pre-punched stainless steel or aluminium helping hand brackets to aluminium support profiles. Pre-assembled captive sliding washer. Buffer zone between the screw head and sliding washer prevents excessive clamp load to the joint.



Material A4 Austenitic Stainless Steel

Fixing

Length	25mm
Washer option	E14

 **EJOT® A/F 8 VARIO Tool**

3

Insulation fastening

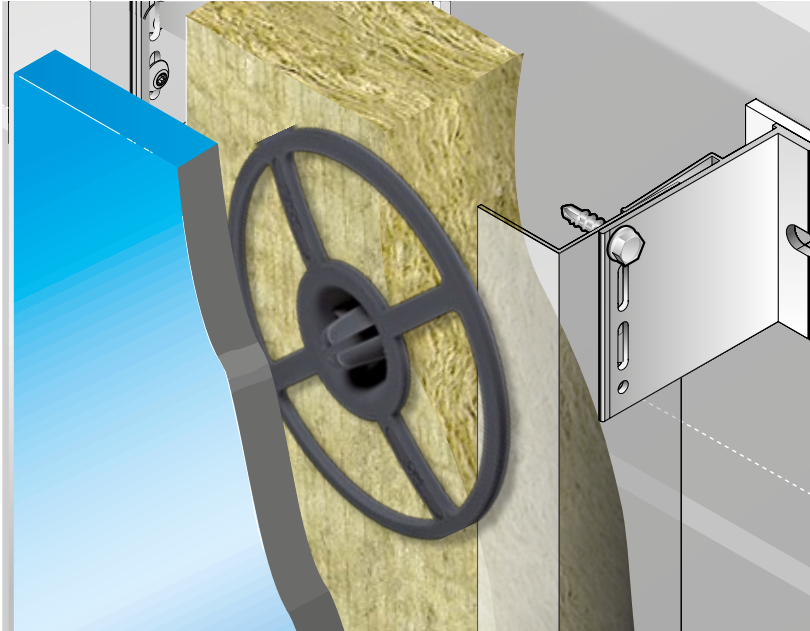

A range of insulation support anchors and fasteners that are both tailored and engineered for the wide variations of backing structures found in application. EJOT provides fastening solutions that accommodate both rigid board and mineral wool insulants with options that meet perimeter and stainless steel centre-fix requirements. Our products are designed and manufactured by EJOT to meet the compliance and performance of rainscreen insulation standards.

Insulation to concrete and masonry

Insulation through sheathing boards to light steel frame

For product information and technical support, please call Support team **01977 687040** or visit **EJOT UK** online



Find the right fasteners and anchors for your façades application

EJOT UK has developed a Rainscreen fasteners specifier app, available for iOS and Android devices - FREE to download.



Insulation to concrete and masonry

**DH Two part insulation anchor
DH 8 x Length Shaft
DH 90 Disk**

**2-Piece high grade plastic
Shaft / Washer combination**

Application

Installing mineral wool rainscreen insulation to concrete and solid masonry.



Material	High Grade Plastic
Fixing	
Lengths	60 to 300mm (insulation thickness)
Washer	DH 90mm Disc
Embedment	30mm with 8mm pilot hole
Hammer set	

**TRIO TT and TRIO TO
Insulation support anchor with
steel pin / plastic pin option**

Application

Installing rigid rainscreen insulation boards to concrete and solid masonry.



Material	High Grade Plastic
Fixing	
Lengths	120 to 300mm
Plastic pin option	TRIO TT
Steel pin option	TRIO TO
Spreader washers	VT 90 and SBL 140 are available to use with mineral wool
Embedment	30 - 60mm (substrate dependant) with 10mm pilot hole

**TID-T 8/60 x Length
Insulation Support Anchor with choice of
pin colours**

Application

Installing rigid rainscreen insulation boards to concrete and solid masonry.



Material	High Grade Plastic, Zinc-plated Carbon Steel expansion pin
Fixing	
Lengths	75 to 295mm
Embedment	35mm
Hole depth	45mm
Hole diameter	8mm

**DMH 8 x Length E
Firewall Insulation Support Anchor**

Application

Installing fire barriers or mineral wool or rigid rainscreen insulation to concrete and solid masonry This anchor can be used in conjunction with the DMT-80-E A2 Stainless Steel spreader washer depending upon the application.



Material	A2 Stainless Steel Tubular bodied anchor
Fixing	
Lengths	80 to 300mm
Embedment	50mm
Hole depth	60mm
Hole diameter	8mm
Washer option	DMT 80 E

Insulation to sheathing boards to light steel frame

SW8-R Fastener / SBH-T

Fastener / Washer combination

Application

Installing insulation to or via sheathing boards (Check with EJOT technical for sheathing board suitability) to light steel from 0.9mm to 1.2mm.



SW8-R Fastener
ETA 07/0013



Fastener Material Carbon Steel with organic corrosion resistant finish

Washer Material High grade plastic

Fixing

Lengths 60 to 240mm
Drilling capacity 0.7 - 1.2mm
Washer option SBH-T

8mm Clip hex one piece socket

TKR Fastener / SBH-T

Fastener / Washer combination

Application

Installing insulation to or via sheathing boards (Check with EJOT technical for sheathing board suitability) to light steel from 0.9mm to 1.2mm.



TKR Fastener
ETA 07/0013



Fastener Material Carbon Steel with organic corrosion resistant finish

Washer Material High grade plastic

Fixing

Lengths 35 to 300mm
Drilling capacity 0.7 - 1.2mm
Washer option SBH-T

P2 drive bit

TKE Fastener / SBH-T

Fastener / Washer combination

Application

Installing insulation to or via sheathing boards (Check with EJOT technical for sheathing board suitability) to light steel from 0.9mm to 1.2mm.



TKR Fastener
ETA 07/0013



Fastener Material A4 Stainless Steel with hardened drill point

Washer Material High grade plastic

Fixing

Lengths 50 to 200mm
Drilling capacity 0.7 - 1.2mm
Washer option SBH-T

P2 drive bit

SBH-T Washer Colour Options

Colour matching options are available on all SBH-T plastic insulation washers

Application

For use with a wide variety of fasteners including SW8-R, TKR and TKE.



ETA 15/0231

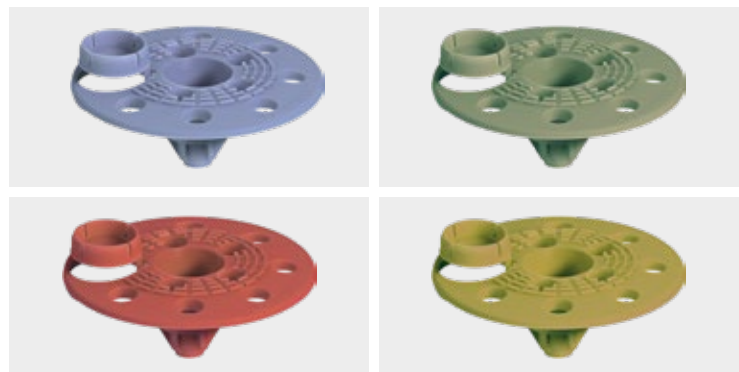

Insulation to sheathing boards to light steel frame

JT2-D6 5.5/6.3 x Length

Self-drilling ‘light to medium’ section High-thread Fastener

Application

Installing insulation to or via sheathing boards (Check with EJOT technical for sheathing board suitability) to light steel from 1.2mm to 6.0mm.



Material Carbon Steel with organic corrosion-resistant finish

Fixing

Lengths 62 to 262mm

Non-bonded washer options SBH-T and SBV 6.5/90

Bonded washers options apply for rainscreen composite backing wall

 **8mm Clip hex one piece socket**

JT3-D6H 5.5/6.3 x Length

Bi-met self-drilling ‘light to medium’ section high thread fastener

Application

Installing insulation or Brick tie channels to or via sheathing boards (Check with EJOT technical for sheathing board suitability) to light steel from 1.2mm to 6.0mm.



ETA 13/0177



Material A2 Austenitic Stainless Steel with Carbon Steel drill point

Fixing

Lengths 67 to 267mm

Non-bonded washer options SBH-T and SBV 6.5/90

Bonded washers options apply for rainscreen composite backing wall

 **8mm Clip hex one piece socket**

JT6-D6H 5.5/6.3 x Length

Bi-met self-drilling ‘light to medium’ section high thread fastener

Application

Installing insulation or Brick tie channels to or via sheathing boards (Check with EJOT technical for sheathing board suitability) to light steel from 1.2mm to 6.0mm.



ETA 13/0177



Material A4 Austenitic Stainless Steel with Carbon Steel drill point

Fixing

Lengths 107 to 237mm

Non-bonded washer options SBH-T and SBV 6.5/90

Bonded washers options apply for rainscreen composite backing wall

 **8mm Clip hex one piece socket**

DMT 85/7E

Centre-fix Washer for mineral wool insulation

Application

Stainless Steel insulation support washer for use with a range Stainless Steel fasteners including JT3-D-6H and JT6-D-6H ranges.



Material A2 Austenitic Stainless Steel

Specifications

Outer diameter 85mm

Inner diameter 7mm

Thickness 0.5mm

Insulation to sheathing boards to light steel frame

HTV 40 SS

Rigid Insulation Support Washer

Application

Stainless Steel insulation support washer. Can be used in conjunction with the DMT spreader washer for load spreading.



Material A2 Stainless Steel

Specifications

Outer diameter	40mm
Inner diameter	8mm
Thickness	1.5mm

SBV 6.5/90

Insulation Support Washer

Application

Insulation support washer for use in conjunction with a wide range of EJOT fasteners including TKR, JT3-ST-2, SW8-R, JT2-D-6, JT3-D-6H and JT6-D-6H ranges.



Material High grade plastic

Specifications

Outer diameter	90mm
Inner diameter	6.5mm

IT/S 5/60

Insulation Support Washer

Application

Insulation support washer. Can be used in conjunction with EJOT VHT-R, TKR and TKE fasteners.



Material High grade plastic

Specifications

Outer diameter	60mm
Inner diameter	5.4mm

4

Exterior façade panel / system fastening

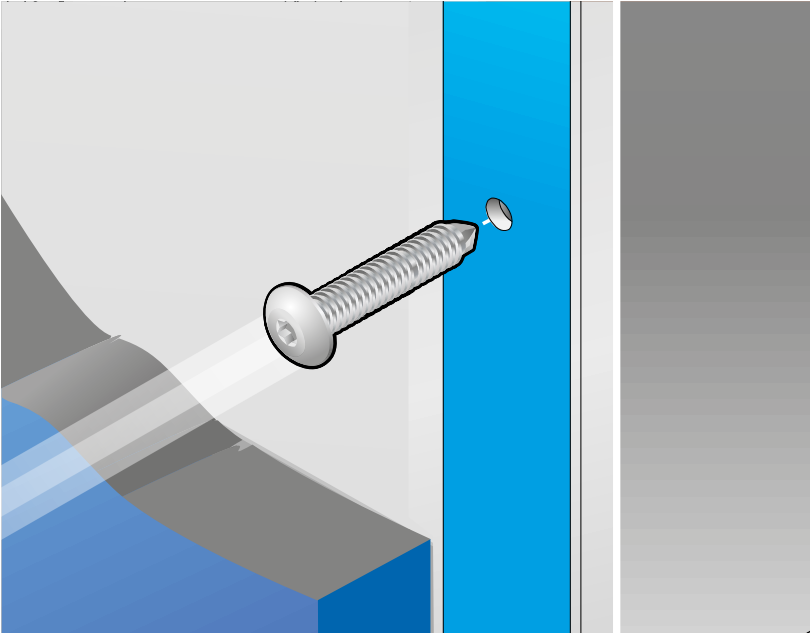

Stainless Steel and bi-metal low profile self-drilling fasteners

Colour match powder-coating is available for most low profile stainless steel fasteners in this range. Please ask for details.



EJOT fasteners are tailored for the full range of façade cladding panel materials and systems including timber, aluminium, steel and high pressure laminates. Innovative solutions include the PTS rear secret-fixed solution with dedicated stop drill. Our ACM and fibrous cladding panel ‘face fixing’ solutions incorporate grommets for fixed and floating point applications.

An extensive range of powder coated coloured options and EJOT’s colour matching service for non-standard colours is available to support the most imaginative design pallet.

For product information and technical support, please call Support team 01977 687040 or visit EJOT UK online



Find the right fasteners and anchors for your façades application

EJOT UK has developed a Rainscreen fasteners specifier app, available for iOS and Android devices - FREE to download.



Timber cladding to timber

JT4-S-2- 4.8 x Length

Stainless Steel Low Profile
Self-drilling Fastener

Application

Self countersinking for timber cladding to timber.



Material	A2 Austenitic Stainless Steel
Fixing	
Lengths	38, 48mm
T25 Drive	

Pierce point fastener for clip secured façade systems

JF3-STX-2-4.8 x 25

Stainless Steel Self-piercing Clip
Fastener

Application

Fixing fully supported metal brackets to OSB and composite panel backing structure.



Material	A2 Austenitic Stainless Steel with carbon steel drill point
Fixing	
Length	25mm
T20W Drive	

Powder coated RAL colour options

Colour match powder-coating is available for most low profile Stainless Steel fasteners in this range. Please ask for details.



JT4-FR-2-4.9 x 35

Stainless Steel Low Profile
Self-drilling Fastener

Application

Aluminium sheet to timber.



Material	A2 Austenitic Stainless Steel
Fixing	
Length	35mm
Washer option	S12
T25 Drive	



ETA 10/0200



Powder coated RAL colour options

Colour match powder-coating is available for most low profile Stainless Steel fasteners in this range. Please ask for details.

JT4-FR-4-4.8/5.5 x Length

**Stainless Steel Low Profile
Self-drilling Fastener**

Application

Steel or aluminium Facade panels and sections to steel or aluminium 1.5 - 4.0mm.



Material A2 Austenitic Stainless Steel

Fixing

Length 19mm

Washer option S12



JT3-FR-3-5.5 x 50

**Bi-met Self-drilling Low Profile
Fastener**

Application

Steel or aluminium facade panels and sections to steel or aluminium 1.2 - 3.0mm.



Material Austenitic Stainless Steel with Carbon Steel drill point

Fixing

Length 50mm

Washer option S12



ETA 10/0200

JT3-FR-6-5.5 x Length

Bi-met Self-drilling Low Profile Fastener

Application

Steel or aluminium sheet facade panels and sections to steel or aluminium 1.2 - 6.0mm



Material A2 Austenitic Stainless Steel with Carbon Steel drill point

Fixing

Lengths 25, 35mm

Washer option S12



ETA 10/0200

JT3-FR-2 4.9 x 35

Bi-met Self-drilling Low Profile Fastener

Application

Steel or aluminium sheet Facade panels and sections timber.



Material A2 Austenitic Stainless Steel with Carbon Steel drill point

Fixing

Length 35mm

Washer option S12



ETA 10/0200



Powder coated RAL colour options

Colour match powder-coating is available for most low profile Stainless Steel fasteners in this range. Please ask for details.

JT6-FR-6 5.5 x 25

Bi-met Self-drilling Low Profile Fastener

Application

Installing steel and aluminium to steel or aluminium 1.2mm to 6.0mm.



ETA 13/0177

Material A4 Austenitic Stainless Steel with Carbon Steel drill point

Fixing

Length 25mm

Washer option S12

T25 Drive

JT6-FR-12 5.5 x 40

Bi-met Self-drilling Low Profile Fastener

Application

Steel or aluminium facade panels and sections to steel or aluminium 4.0 - 12.0mm



ETA 13/0177

Material A4 Austenitic Stainless Steel with Carbon Steel drill point

Fixing

Length 40mm

Washer option S12

T25 Drive

JT3-LT3-5.5 X 25

Bi-met Self-drilling Low Profile Fastener

Application

Installing steel and aluminium to steel or aluminium 1.2mm to 3.0mm .



Material Austenitic Stainless Steel with Carbon Steel drill point

Fixing

Length 25mm

T25 Drive

JT4-LT-2/6-6.0 x 25

Stainless Steel Self-drilling Centering Grommet

Application

For fixing facade panels to 1.5-2.0 mm aluminium substructures: Can be combined with LT fixed and floating point sleeves.

Note: Please note the respective approval of the facade panel and the assembly instructions of the manufacturer.



Material A2 Austenitic Stainless Steel

Fixing

Length 25mm

Head diameter 16mm

Washer option Gromet

T25 Drive



Powder coated RAL colour options

Colour match powder-coating is available for most low profile Stainless Steel fasteners in this range. Please ask for details.

JT4-LT-2/6-6.0 x Length

Stainless Steel Self-drilling Centering Grommet

Application

Fastening facade panels to timber and aluminium substructures: Can be combined with LT fixed and floating point sleeves.

Note: Please note the respective approval of the facade panel and the assembly instructions of the manufacturer.



Material A2 Austenitic Stainless Steel

Fixing

Lengths 40, 50mm

Head diameter 16mm

Washer option Gromet

 **T25 Drive**

JT4-FR-2H/6-4.8 x 22

Stainless Steel Self-drilling Fastener and Centering Grommet for ACM

Application

Installing 4mm ACM Panels to 2.0mm Aluminium Sections.



Material A2 Austenitic Stainless Steel

Fixing

Length 22mm

Washer option Gromet

 **T25 Drive**

SSAL 4.8 x Length

High Pressure Laminate Rivets

Application

Installing high pressure laminate boards to aluminium sections.



Material Aluminium body with A2 Stainless Steel mandrel

Fixing

Lengths 18, 23mm

See 'Accessories' Centralising tool and Rivet spacer nose piece

PTS 60 x Length

Stainless Steel Self-tapping Fastener

Application

Installing 5mm thick concealed brackets to the rear of high pressure laminate boards.



Material A4 Austenitic Stainless Steel

Fixing

Lengths 9.5, 11.5, 14.5mm

 **T30 Drive**

See "Accessories" for dedicated stop drill bits.

Accessories, drive bits and drill bits

With the vast amount of research and development invested into the design and manufacture of all EJOT fastening systems, installation tools are key to optimising product performance.

These tools and accessories have been designed specifically for use with EJOT fastening products to deliver correct installation features such as drive speed, torque etc. as well as maximising efficiency for the installer.



Chemical Resin Kit

Accessory Kit incorporates:

- 6 mixer Nozzles
- 4 Diameter brushes
- 190mm blow pump
- Applicator gun 410ml
- Nylon Sleeves



High pressure Laminate rivet centering tool

Fits standard drilling machines. Ensures centralised alignment between holes.



PTS Stop Drill



13mm Hex One Piece Socket



8mm Hex One Piece Socket



Drive Bits T25, T30, T40



Phillips Drive Bits P2 and P3
For use with mag bit holder.



For further information on specific installation accessories visit EJOT online at www.ejot.co.uk

or talk to a member of our Technical Team on **01977 687040**.

Backing structure framing fasteners



Images courtesy of IPS Group

Light steel framing systems, designed to provide the backing structure for a rainscreen installation are becoming more popular. EJOT offers a wide range of fastener options for frame to frame fixing to accommodate the lighter track and studs through to the thicker, more structural sections.

Fasteners that attach the framing system back to heavy steel supporting structures, along with a wide range of specialist ETA compliant anchors and chemical systems for masonry and concrete structures, provide designers and structural engineers with the greatest flexibility and proven performance.

Sheathing board fasteners to accommodate various stud arrangements and materials complete the fastener range for a complete and holistic solution.

Base / head channel to concrete

Vertical rail to head track and base track

Sheathing boards to light steel frame

Sheathing boards to aluminium

Sheathing boards to timber frame

For product information and technical support, please call Support team **01977 687040** or visit EJOT UK online



Find the right fasteners and anchors for your façades application

EJOT UK has developed a Rainscreen fasteners specifier app, available for iOS and Android devices - FREE to download.



Base / head channel to concrete

4H Carbon Steel 6.3 x Length

Self-tapping Masonry Anchor

Application

Typical applications include steel sections, brackets or tracking being fixed to concrete or solid brick.

The fastener provides a corrosion resistant finish in zinc blue.



Material Carbon Steel

Fixing

Lengths	32, 45mm
Min to max embedment	25 - 32mm
Effective clamping thickness	0 - 20mm
Drill bit diameter	5mm

8mm Clip hex one piece socket

BS R 6.3 x Length

Self-tapping Anchor

Application

Manufactured in case hardened steel with a high performance coating to enhance corrosion resistance. For mechanical fixing of Base / Head Channel to concrete.



Material Case-hardened Steel with organic corrosion resistant coating

Fixing

Lengths	35,45,100 - 240mm
Min to max embedment	30 - 45mm
Effective clamping thickness	0 - 210mm
Drill bit diameter	5mm

8mm Clip hex one piece socket

Bi-met Masonry Anchor 7.5 x 45

304 Stainless Steel Bi-Met

Application

Installed with a 10mm 'Hex drive system, typical applications include steel sections, brackets or tracking being fixed to concrete or solid brick.

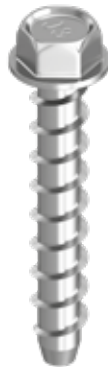

Material Grade 304 Stainless Steel with Carbon Steel lead-threads

Fixing

Lengths	45mm
Min to max embedment	30 - 40mm
Effective clamping thickness	0 - 15mm
Drill bit diameter	6mm

10mm Clip hex one piece socket

SDF-KB 10V x Length E

Screw-set Anchor

Application

Installing helping hand brackets and metal sections to concrete and masonry.



Material A4 Stainless Steel with nylon plug

Fixing

Lengths	50, 60, 70mm
Min Embedment Concrete	40mm
Min Embedment Masonry	50mm
Hole Diameter	ø 10mm

13mm Hex one piece socket or T40 Drive



ETA 10/0305

Base / head channel to concrete

BA-E 8 Range

Anchor Bolt

Application

Installing helping hand brackets and metal sections to dense concrete.



ETA 14/0219



Material A4 Stainless Steel, A4 Stainless Steel HCR

Fixing

Lengths	72 to 147mm
Min Embedment	45mm
Effective Clamping Thickness	10 to 85mm
Bolt Diameter	ø 8mm

 **13mm socket**

BA-E 10 Range

Anchor Bolt

Application

Installing helping hand brackets and metal sections to dense concrete.



ETA 14/0219



Material A4 Stainless Steel, A4 Stainless Steel HCR

Fixing

Lengths	92 to 132mm
Min Embedment	60mm
Effective Clamping Thickness	10 to 50mm
Bolt Diameter	ø 10mm

 **17mm socket**

BA-E 8 Plus Range

Anchor Bolt

Application

Installing helping hand brackets and metal sections to dense concrete.



ETA 18/0219



Material A4 Stainless Steel

Fixing

Lengths	75 to 150mm
Min Embedment	48mm
Effective Clamping Thickness	10 to 85mm
Bolt Diameter	ø 8mm

 **13mm socket**

BA-E 10 Plus Range

Anchor Bolt

Application

Installing helping hand brackets and metal sections to dense concrete.



ETA 18/0219



Material A4 Stainless Steel

Fixing

Lengths	72 to 162mm
Min Embedment	40mm
Effective Clamping Thickness	10mm to 100mm
Bolt Diameter	ø 10mm

 **17mm socket**

Base / head channel to concrete

Chemical Resin & Stud M8

Multifix VSF Chemical Anchoring System

Application

Installing helping hand brackets and metal sections to Concrete (cracked & uncracked) brick, block & perforated brick.



ETA 13/0918



Material Multix VSF: Styrene-free, low-odour 'high reactivity' vinylester resin.
Stud M8: Available in BZP finish or A4 Stainless Steel.

Fixing

Standard Embedment Range	80 - 125mm
Torque Range	10 - 140Nm
Drill Diameter	ø 10mm

Chemical Resin & Stud M10

Multifix VSF Chemical Anchoring System

Application

Installing helping hand brackets and metal sections to Concrete (cracked & uncracked) brick, block & perforated brick.



ETA 13/0918



Material Multix VSF: Styrene-free, low-odour 'high reactivity' vinylester resin.
Stud M10: Available in BZP finish or A4 Stainless Steel.

Fixing

Standard Embedment Range	80 - 125mm
Torque Range	10 - 140Nm
Drill Diameter	ø 10mm

Head and base track to stud and stud to stud

JT2-NH3-5.5 x 19

Carbon Steel Self-drilling Fastener

Application

Steel section to steel section where the combined thickness is not greater than 3.0mm.



Material Carbon Steel with organic corrosion resistant finish

Fixing

Length	19mm
Washer option	Unwashed

P2 Drive Bit

JT2-LH6-5.5 x 22

Carbon Steel Self-drilling Fastener

Application

Steel section to steel section where the combined thickness is not greater than 6.0mm.



Material Carbon Steel with organic corrosion resistant finish

Fixing

Lengths	22mm
Washer option	Unwashed

8mm CF one piece socket

Head and base track to stud and stud to stud

LSCF 5.5 x 25

Carbon Steel Self-drilling Fastener

Application

Steel section to steel section from 1.2mm to 3.0mm.



Material Carbon Steel with organic corrosion resistant finish

Fixing

Lengths 25mm

Washer option Unwashed



HSCF 5.5 x 38

Carbon Steel Self-drilling Fastener

Application

Steel section to steel section from 4.0mm to 12.0mm.



Material Carbon Steel with organic corrosion resistant finish

Fixing

Lengths 38mm

Washer option Unwashed

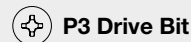

Sheathing board to steel frame

TBF 4.8 x Length

Carbon Steel Self-drilling Fastener

Application

Sheathing board or timber to light steel frame from minimum 0.9mm to 3.0mm.



Material Carbon Steel with organic corrosion resistant finish

Fixing

Lengths 30, 45, 66mm

Washer option Unwashed

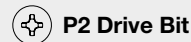

WDLS 5.5 x Length

Carbon Steel Self-drilling Fastener

Application

Sheathing board or timber to light steel frame from minimum 1.5mm to 3.0mm.



Material Carbon Steel with organic corrosion resistant finish

Fixing

Lengths 65, 85, 127mm

Washer option Unwashed

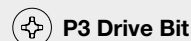

Sheathing board to steel frame

WDHS 5.5 x Length

Carbon Steel Self-drilling Fastener

Application

Sheathing board or timber to light steel frame from minimum 4.0mm to 10.0mm.



Material Carbon Steel with organic corrosion resistant finish

Fixing

Lengths 65, 95, 119mm

Washer option Unwashed

P3 Drive Bit

JT3-WD-6-5.5 x Length

Bi-met Self-drilling Fastener

Application

Sheathing board or timber to light steel frame from minimum 2.0mm to 6.0mm.



Material A2 Austenitic stainless Steel with carbon steel drill point

Fixing

Lengths 46, 65mm

Washer option Unwashed

T25 Drive

JT3-STS-2-6.0 x 28

Bi-met Self-drilling Low Profile Fastener

Application

Sheathing board or timber to light steel frame from minimum 0.7mm to 1.0mm.



Material A4 Austenitic stainless Steel with carbon steel drill point

Fixing

Length 28mm

Washer option Unwashed

T25 Drive

Sheathing boards to aluminium

JT4-STS-3-4.8 x 35

Stainless Steel Self-drilling Low Profile Fastener

Application

Installing sheathing boards to aluminium from 1.5mm to 3.0mm.



Material A2 Stainless Steel

Fixing

Length 35mm

Washer option Unwashed

T25 Drive

Sheathing boards to timber frame

TKR 4.8 x Length

Carbon Steel Self-drilling Fastener

Application

Sheathing board to timber frame or light steel sections.



ETA 07/0013



Material Carbon Steel with organic corrosion resistant finish

Fixing

Lengths 35 to 300mm

Drilling capacity 0.7 -1.2mm



Cross-recess P2 Drive

VHT-R 4.8 x Length

Carbon Steel Self-drilling Fastener

Application

Sheathing board to timber frame or light steel sections.



ETA 07/0013



Material Carbon Steel with organic corrosion resistant finish

Fixing

Lengths 50 to 200mm

Drilling capacity 0.5 -0.9mm



Cross-recess P2 Drive

TKE 4.8 x Length

Stainless Steel Self-drilling Fastener

Application

Sheathing board Timber Frame.



ETA 07/0013



Material A2 Austenitic Stainless Steel with Carbon Steel drill point

Fixing

Lengths 50 to 200mm

Drilling capacity 0.7 -1.2mm



Cross-recess P2 Drive

JT3-ST-2-6.0 x Length

Stainless Steel Self-drilling Fastener

Application

Sheathing board Timber Frame.



Material A2 Stainless Steel with Carbon Steel drill point

Fixing

Lengths 35 to 200mm

Drilling capacity 0.7 -1.6mm



T25 Drive

The complete solution for the modern building envelope

This catalogue showcases our current portfolio of high performance fastening systems for fixing rainscreens, building envelopes and rear ventilated façades.

This range is further complemented by other highly specialist products and systems, all designed, manufactured and supported by the EJOT Group, worldwide.

Technical guidance and support for all EJOT products, is available through a national frontline team of experienced sales engineers, supported by a thoroughly knowledgeable and responsive customer services team, based at our manufacturing centre near Leeds.



EJOT Rainscreen Specification APP

This interactive design guide provides a complete specification route through the four key installation stages, presenting safe, reliable rainscreen installation.

Available to download free for IOS and Android tablets.



Roofing & Cladding

The complete fastening solutions for modern building envelopes.



Membrane Roofing Systems

Innovative fastening systems for insulation and pvc membrane to all decks.



Hazardous Environments

Specialist products developed for highly corrosive environments.



Concrete, Brick and Block

Proven fastening and anchoring systems for all masonry substrates.



Solar Installation

International product overview for all solar system installations.



External Wall Insulation

Full specification, product and accessory guide for ETICS professionals.



EJOT U.K. Limited,
Hurricane Close,
Sherburn Enterprise Park,
Sherburn-in-Elmet,
Leeds LS25 6PB.
United Kingdom

Tel: +44 1977 68 70 40
Fax: +44 1977 68 70 41
Email: info@ejot.co.uk

www.ejot.co.uk



EJOT® The Quality Connection