

Innovazione Ricerca Design



Da più di 40 anni, portiamo nei saloni la qualità, l'innovazione, la ricerca e la passione del vero Made in Italy. Mettiamo la nostra esperienza a servizio dell'hairstylist, offrendo una linea completa e moderna di arredamenti, apparecchi elettrici e complementi tutti di nostra produzione. Il nostro marchio è la migliore garanzia che possiamo offrire ai professionisti che - ogni giorno - scelgono i nostri prodotti per il loro lavoro. Siamo Ceriotti: sempre un passo avanti.



ARREDAMENTO



ARREDAMENTO



Posti di lavoro
Workstations  pag 4

Poltroncine
Chairs  pag 48

Poltrone uomo
Men's Chairs  pag 84

Lavaggi
Washes  pag 112

Divanetti
Sofas  pag 158

Casse
Receptions  pag 168

Skai
Skai  pag 190

Finiture
Finishes  pag 196



PRESTIGE



GLAMOUR

Legenda



SKAI



FINITURE



ALZAGAMBE



VIBRO MASSAGGIO



MASSAGGIO SHIATSU



CLUB HOUSE



TAILOR MADE





POSTI DI LAVORO

Workstations

- STATE S** pag 6
- NAMI** pag 8
- VERSO** pag 10
- O'CLOCK** pag 14
- KOBY MIRROR** pag 16
- LIGHT** pag 18
- LUME** pag 19
- BACKSTAGE** pag 20
- AMBIENTE ATENE** pag 22
- STYLO** pag 24
- ROY S** pag 26
- IDEO PLUS** pag 28
- EXPO** pag 30
- ESSENTIAL** pag 31
- MEMORY S** pag 32
- FAIR** pag 34
- JILL** pag 38
- EKO S** pag 40
- BOX** pag 44
- SQUARED** pag 45
- MOBILETTI** pag 46
- ACCESSORI** pag 47

MILANO



P9879N

STATE S

Struttura in nobilitato completa di cassetto, vani a giorno, porta phon e porta piastra estraibile. Pianetto in cristallo con supporti in alluminio satinato. Finiture a scelta.

Structure in melamine with drawer, open compartments, pull-out holder for hair-dryer and straightener. Glass top with satin aluminum supports. Wide range of finishes available.

Structure en mélamine avec tiroir, compartiments ouverts, support amovible pour séchoir et fer à lisser. Top en verre avec supports en aluminium givré. Large gamme de finitions disponibles.

Struktur aus Melamin mit Schublade, offene Fächer, ausziehbarer Halter für Haartrockner und Haarglätter. Glasplatte mit satinierten Aluminiumträgern. Breite Palette von Ausführungen verfügbar.

Estructura en melamina con cajón, compartimentos abiertos, soporte extraíble para secador y plancha. Estante de cristal con soportes de aluminio satinado.

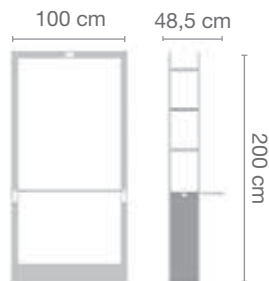

P9879S



P9896N



STATE S-db

Struttura in nobilitato completa di cassetto, vani a giorno, porta phon e porta piastra estraibile. Pianetto in cristallo con supporti in alluminio satinato. Finiture a scelta.

Structure in melamine with drawer, open compartments, pull-out holder for hair-dryer and straightener. Glass top with satin aluminum supports. Wide range of finishes available.

Structure en mélamine avec tiroir, compartiments ouverts, support amovible pour séchoir et fer à lisser. Top en verre avec supports en aluminium givré. Large gamme de finitions disponibles.

Struktur aus Melamin mit Schublade, offene Fächer, ausziehbarer Halter für Haartrockner und Haarglätter. Glasplatte mit satinierten Aluminiumträgern. Breite Palette von Ausführungen verfügbar.

Estructura en melamina con cajón, compartimentos abiertos, soporte extraíble para secador y plancha. Estante de cristal con soportes de aluminio satinado.

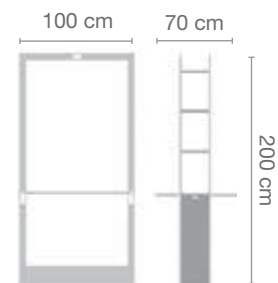



P9881N

NAMI



P9881G

Struttura in vetroresina in diversi colori a scelta.

Fiberglass structure in different colors of your choice.

Structure en fibre de verre de différentes couleurs à choisir.

Fiberglas-Struktur in verschiedenen Farben Ihrer Wahl.

Estructura de fibra de vidrio en diferentes colores a elección.

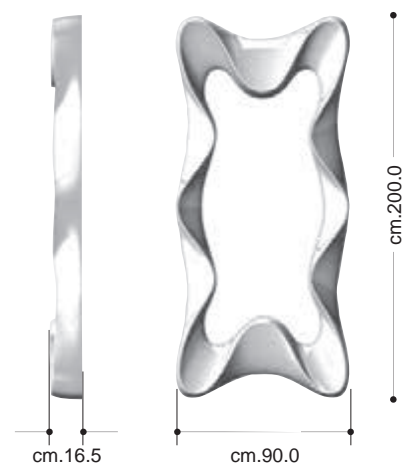

○ ● ●
Colori / Colours

VERSO 2 VERSO 2-P

Piano in laminato bianco. Supporti portasp specchio bianchi. Specchi stratificati doppi. Gambe in alluminio. Porta phon opzionali. Finiture a scelta.

Worktop in white laminated wood. White mirror supports. Double layered mirrors. Aluminum legs. Optional hairdryer holders. Wide range of finishes available.

Top en bois stratifié blanc. Supports de miroir blanc. Miroirs à double couche. Jambes en aluminium. Porte-sèche-cheveux en option. Large gamme de finitions disponibles.

Arbeitsplatte aus weißem Schichtholz. Weiße Spiegelhalterungen. Doppelschichtspiegel. Beine aus Aluminium. Optionaler Haartrocknerhalter. Breite Palette von Ausführungen verfügbar.

Estante en madera laminada blanca. Soportes para espejo blancos. Espejos de doble capa. Piernas en aluminio. Soporte opcional para secador. Amplia gama de acabados disponibles.



P9897P

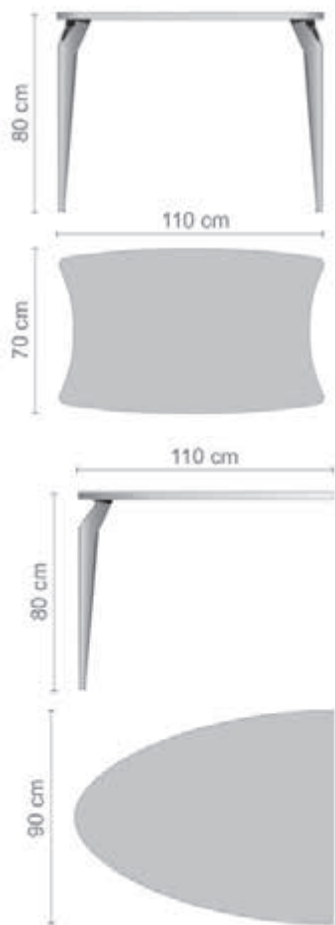

P9898



P9899SP

VERSO 3

Piano in laminato bianco. Supporti portasp specchio bianchi. Specchi stratificati doppi. Gambe in alluminio. Porta phon opzionali. Finiture a scelta.

Worktop in white laminated wood. White mirror supports. Double layered mirrors. Aluminum legs. Optional hairdryer holders. Wide range of finishes available.

Top en bois stratifié blanc. Supports de miroir blanc. Miroirs à double couche. Jambes en aluminium. Porte-sèche-cheveux en option. Large gamme de finitions disponibles.

Arbeitsplatte aus weißem Schichtholz. Weiße Spiegelhalterungen. Doppelschichtspiegel. Beine aus Aluminium. Optionaler Haartrocknerhalter. Breite Palette von Ausführungen verfügbar.

Estante en madera laminada blanca. Soportes para espejo blancos. Espejos de doble capa. Piernas en aluminio. Soporte opcional para secador. Amplia gama de acabados disponibles.



P9899

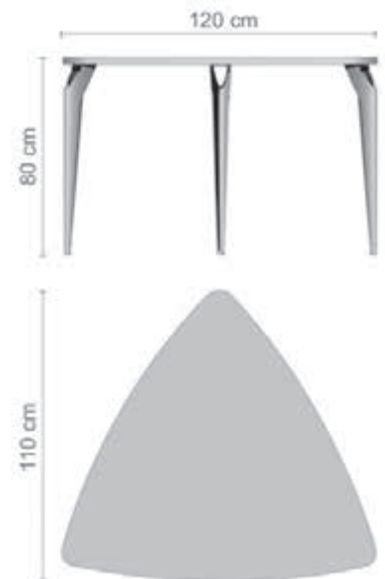



P9800P

VERSO 4-R

Piano in laminato bianco. Supporti portasp specchio bianchi. Specchi stratificati doppi. Gambe in alluminio. Porta phon opzionali. Finiture a scelta.

Worktop in white laminated wood. White mirror supports. Double layered mirrors. Aluminium legs. Optional hairdryer holders. Wide range of finishes available.

Top en bois stratifié blanc. Supports de miroir blanc. Miroirs à double couche. Jambes en aluminium. Porte-sèche-cheveux en option. Large gamme de finitions disponibles.

Arbeitsplatte aus weißem Schichtholz. Weiße Spiegelhalterungen. Doppelschichtspiegel. Beine aus Aluminium. Optionaler Haartrocknerhalter. Breite Palette von Ausführungen verfügbar.

Estante en madera laminada blanca. Soportes para espejo blancos. Espejos de doble capa. Piernas en aluminio. Soporte opcional para secador. Amplia gama de acabados disponibles.



P9800S



P9801S



VERSO 4-O

Piano in laminato bianco. Supporti portasp specchio bianchi. Specchi stratificati doppi. Gambe in alluminio. Porta phon opzionali. Finiture a scelta.

Worktop in white laminated wood. White mirror supports. Double layered mirrors. Aluminum legs. Optional hairdryer holders. Wide range of finishes available.

Top en bois stratifié blanc. Supports de miroir blanc. Miroirs à double couche. Jambes en aluminium. Porte-sèche-cheveux en option. Large gamme de finitions disponibles.

Arbeitsplatte aus weißem Schichtholz. Weiße Spiegelhalterungen. Doppelschichtspiegel. Beine aus Aluminium. Optionaler Haartrocknerhalter. Breite Palette von Ausführungen verfügbar.

Estante en madera laminada blanca. Soportes para espejo blancos. Espejos de doble capa. Piernas en aluminio. Soporte opcional para secador. Amplia gama de acabados disponibles.



P9801P





P9845

O'CLOCK



Struttura in poliuretano rigido laccato. Specchio e piano di lavoro con supporti in alluminio pressofuso lucidato e satinato. Doppie prese elettriche schuko e doppi portaphon a scomparsa. Poggiatesta in alluminio pressofuso lucidato e satinato.

Structure in rigid polyurethane lacquered. Mirror and worktop with supports in die-cast polished aluminium. Equipped with two electrical sockets (type schuko) and two concealable supports for hairdryers. Footrest in die-cast aluminium, polished and satin.

Structure en polyuréthane rigide laqué. Miroir et top avec supports en aluminium moulé sous pression, poli et givré. Equipé avec deux prises électriques (type schuko) et deux supports dissimulables pour sèche-cheveux. Reposepieds en aluminium moulé sous pression, poli et givré.

Struktur in starrem Polyurethan lackiert. Spiegel und Arbeitsplatte mit Stützen aus Aluminium-Druckguss. Ausgestattet mit zwei Steckdosen (Typ Schuko) und zwei versenkbaren Halterungen für Haartrockner. Fußstütze aus Aluminium-Druckguss, poliert und glasiert.

Estructura en poliuretano rígido lacado. Espejo y estante con soportes en aluminio fundido a presión, pulido y satinado. Equipado con dos enchufes eléctricos (tipo schuko) y dos soportes extraíbles para secadores. Reposapiés de aluminio fundido a presión, pulido y satinado.

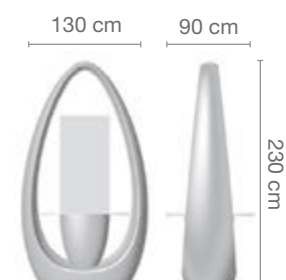



9705



P9804N

KOBY MIRROR

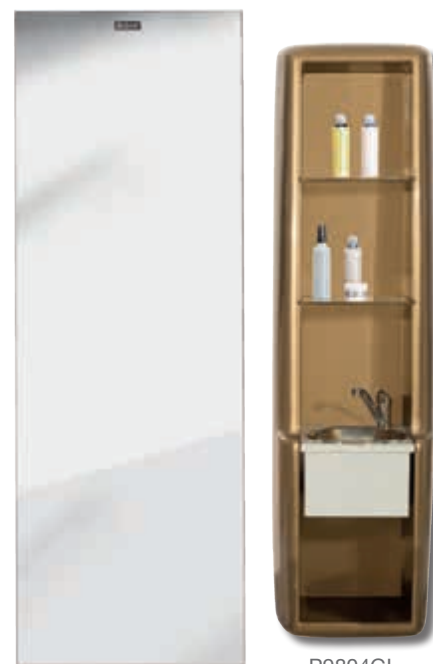

P9804GI

Struttura in vetroresina bianca o nera. Possibilità scelta altri colori a campione con supplemento prezzo. Pianetti in vetro con cassettera o lavello con miscelatore.

Fiberglass structure, white or black. Possibility to choose different sample colors with extra charge. Glass shelves with drawer or sink with mixer.

Structure en fibre de verre, blanc ou noir. Possibilité de choisir des autres couleurs avec un supplément. Étagères en verre avec tiroir ou lavabo avec mélangeur.

Weißer oder schwarzer Fiberglasstruktur. Verschiedene Musterfarben wählbar (Aufpreis). Glasregale mit Schublade oder Becken mit Mischbatterie.

Estructura de fibra de vidrio, blanca o negra. Posibilidad de elección otros colores con suplemento de precio. Estantes de vidrio con cajón o lavabo con mezclador.

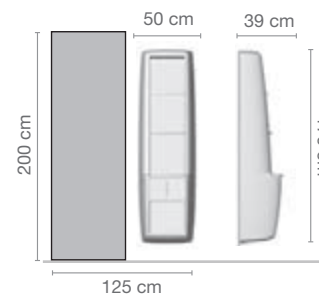

○ ● ●
Colori / Colours



LIGHT

Struttura in nobilitato bianco. Piano in alluminio pressofuso. Banda laterale in metacrilato bianco con retroilluminazione a LED.

Structure in white melamine. Die-cast aluminum top. Side panel in white methacrylate with LED backlighting.

Structure en mélamine blanche. Top en aluminium moulé sous pression. Panneau latéral en méthacrylate blanc avec rétro-éclairage LED.

Struktur aus weißem Melamin. Oberteil aus Aluminiumdruckguss. Seitenteil aus weißem Methacrylat mit LED-Hintergrundbeleuchtung.

Estructura en melamina blanca. Estante de aluminio fundido a presión. Panel lateral de metacrilato blanco con retroiluminación LED.





P9815PT

9701



P9815

LUME

Specchiera con illuminazione LED integrata. Cornice in ABS cromato. Pianetto in vetro con sostegni in alluminio.

Workstation with integrated LED lighting. Chromed ABS frame. Glass shelf with aluminum supports

Miroir avec éclairage LED intégré. Cadre en ABS chromé. Étagère en verre avec des supports en aluminium.

Spiegel mit integrierter LED-Beleuchtung. Verchromter ABS-Rahmen. Glasregal mit Aluminiumstützen.

Espejo con iluminación LED integrada. Marco de ABS cromado. Estante de vidrio con soportes de aluminio.





BACKSTAGE BACKSTAGE ALU



Backstage ALU

Backstage

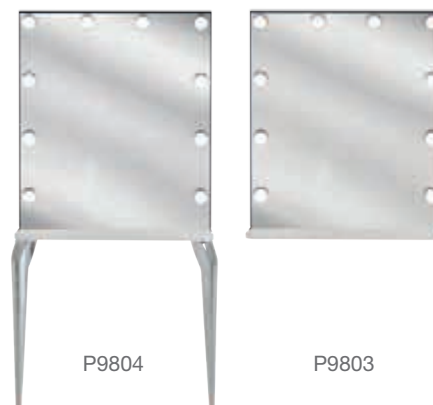

P9804

P9803

Struttura in nobilitato bianco. Specchio incollato con sistema illuminazione. Versione ALU con gambe in alluminio pressofuso lucidato e satinato.

Structure in white melamine. Mirror glued with lighting system. ALU version with polished and satin die-cast aluminum legs.

Structure en mélamine blanche. Miroir collé avec système d'éclairage. Version ALU avec pieds en aluminium moulé sous pression poli et givré.

Struktur aus weißem Melamin. Spiegel mit Beleuchtungssystem geklebt. ALU Version mit polierten und satinierten Beinen aus Aluminiumdruckguss.

Estructura en melamina blanca. Espejo pegado con sistema de iluminación. Versión ALU con patas de aluminio fundido a presión pulido y satinado.

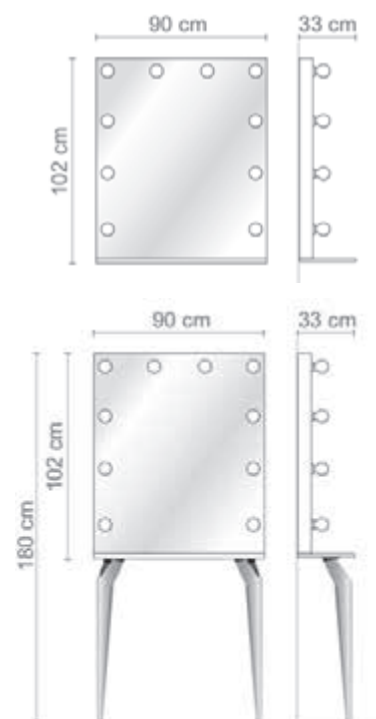





ATENE



G9811B

STYLO

Struttura in vetroresina bianca o nera. Specchio completo di supporti per parete. Piani in laminato (finiture a scelta) e poggiatesta in metallo.

Fiberglass structure, white or black. Mirror with wall supports. Laminated wood worktop (wide range of finishes available) and galvanised metal footrest.

Structure en fibre de verre blanche ou noire. Miroir avec support muraux. Top en bois stratifié (large gamme de finitions disponible) et repose-pieds en métal galvanisé.

Fiberglas-Struktur, weiß oder schwarz. Spiegel mit Wandhalterungen. Arbeitsplatte aus laminiertem Holz (breite Palette von Ausführungen erhältlich) und Fußstütze aus verzinktem Metall.

Estructura de fibra de vidrio blanca o negra. Espejo con soportes para pared. Estante en madera laminada (amplia gama de acabados disponibles) y reposapiés en metal galvanizado.

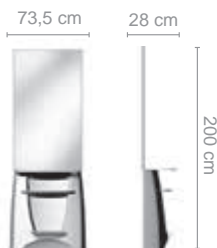

G9811N



○ ●
Colori / Colours



G9810B



G9810N

STYLO 2p

Struttura in vetroresina bianca o nera. Piani in laminato (finiture a scelta) e poggiatesta in metallo. Prese elettriche (tipo Schuko) disponibili su richiesta.

Fiberglass structure, white or black. Laminated wood worktop (wide range of finishes available) and galvanised metal footrest. Electric sockets (type Schuko) available on request.

Structure en fibre de verre blanche ou noire. Top en bois stratifié (large gamme de finitions disponible) et repose-pieds en métal galvanisé. Prises électriques (type Schuko) disponibles sur demande.

Fiberglas-Struktur, weiß oder schwarz. Arbeitsplatte aus laminiertem Holz (breite Palette von Ausführungen erhältlich) und Fußstütze aus verzinktem Metall. Steckdosen (Typ Schuko) auf Anfrage erhältlich.

Estructura de fibra de vidrio blanca o negra. Estante en madera laminada (amplia gama de acabados disponibles) y reposapiés en metal galvanizado. Enchufes eléctricos (tipo Schuko) disponibles en opción.

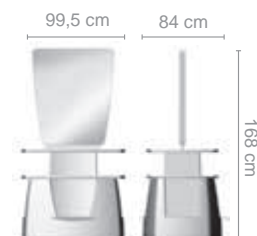

○ ●
Colori / Colours





G9815S

ROY S

Struttura e piano in nobilitato. Retroilluminazione LED disponibile su richiesta.

Structure and worktop in melamine. LED backlighting available on request.

Structure et top en mélamine. Rétro-éclairage LED disponible sur demande.

Struktur und Arbeitsplatte in Melamin. LED-Hintergrundbeleuchtung auf Anfrage erhältlich.

Estructura y estante en melamina. Retroiluminación LED disponible en opción.



G9815B





G9816



ROY S-SOFT

Struttura in nobilitato rivestito di skai con colori a scelta. Piano in nobilitato. Retroilluminazione LED disponibile su richiesta.

Structure in melamine covered with skai with colors of your choice. Melamine worktop. LED backlighting available on request.

Structure en mélamine recouverte de skai en couleurs à choisir. Top en mélamine. Rétro-éclairage LED disponible sur demande.

Struktur in Melamin mit Skai bedeckt (Farben Ihrer Wahl). Arbeitsplatte aus Melamin. LED-Hintergrundbeleuchtung auf Anfrage erhältlich.

Estructura en melamina recubierta de skai con colores a elección. Estante en melamina. Retroiluminación LED disponible en opción.





IDEO PLUS

Cornice in ABS cromato. Pianetto in SAN con sostegno in alluminio e accessori multifunzione.

Chromed ABS frame. SAN shelf with aluminum support and multi-purpose accessories.

Cadre en ABS chromé. Top en SAN avec soutien de aluminium et accessoires multifonctionnels.

Verchromter ABS-Rahmen. SAN-Regal mit Aluminium-Unterstützung und Mehrweckzubehör.

Cornisa de ABS cromado. Estante en SAN con soporte de aluminio y accesorios multipropósito.

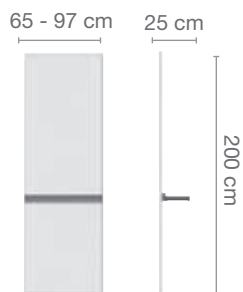



G9883SL



IDEO PLUS LIGHT

Cornice in ABS cromato. Pianetto in SAN con sostegno in alluminio e accessori multifunzione. Completo di illuminazione LED.

Chromed ABS frame. SAN shelf with aluminum support and multi-purpose accessories. With LED lighting.

Cadre en ABS chromé. Top en SAN avec soutien de aluminium et accessoires multifonctionnels. Avec éclairage LED.

Verchromter ABS-Rahmen. SAN-Regal mit Aluminium-Unterstützung und Mehrzweckzubehör. Mit LED-Beleuchtung.

Cornisa de ABS cromado. Estante en SAN con soporte de aluminio y accesorios multipropósito. Con iluminación LED.

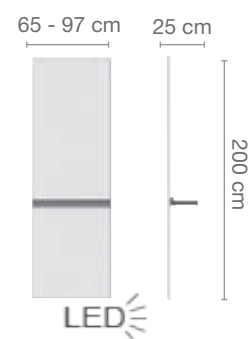



EXPO

Pannello in nobilitato bianco. Piano in SAN con sostegno in alluminio. Inserti in laminato per ripiani e illuminazione LED disponibili su richiesta.

Panel in white melamine. SAN top with aluminum support. Laminate inserts for shelves and LED lighting available on request.

Panneau en mélamine blanche. SAN haut avec support en aluminium. Inserts en stratifié pour étagères et éclairage LED disponibles sur demande.

Panel in weißem Melamin. SAN-Top mit Aluminium-Unterstützung. Lamineinsätze für Regale und LED-Beleuchtung auf Anfrage erhältlich.

Panel en melamina blanca. Parte superior SAN con soporte de aluminio. Insertos laminados para estantes e iluminación LED disponibles en opción.

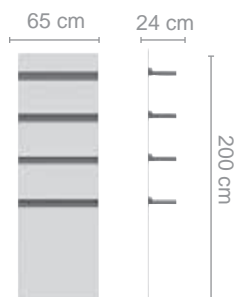

G9900



G9861

9701



ESSENTIAL

Cornice in ABS cromato. Pianetto in vetro con sostegni in alluminio.

Chromed ABS frame. Glass shelf with aluminum supports.

Cadre en ABS chromé. Étagère en verre avec des supports en aluminium.

Verchromter ABS-Rahmen. Glasregal mit Aluminiumstützen.

Marco de ABS cromado. Estante de vidrio con soportes de aluminio.

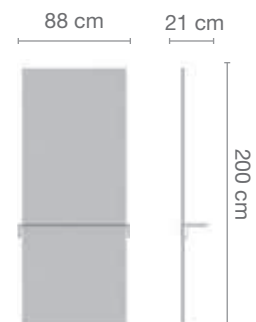



G9817BE

MEMORY S

Struttura in nobilitato bianco, con vani a giorno e piano in alluminio pressofuso. Prese elettriche (tipo schuko) disponibili su richiesta. Altre finiture a scelta.

Structure in white melamine, with open compartments and die-cast aluminum top. Electric sockets (schuko type) available on request. Other finishes available.

Structure en mélamine blanche, avec compartiments ouverts et plateau en aluminium moulé sous pression. Prises électriques (type schuko) disponibles sur demande. Autres finitions disponibles.

Struktur in weißem Melamin, mit offenen Fächern und Aluminium-Druckguss-Top. Steckdosen (Schuko-Typ) auf Anfrage erhältlich. Andere Ausführungen verfügbar.

Estructura en melamina blanca, con compartimentos abiertos y estante de aluminio fundido a presión. Enchufes eléctricos (tipo schuko) disponibles en opción. Otros acabados disponibles.



G9817SE





G9805BE



G9805SE

MEMORY S-db

Struttura in nobilitato bianco, con vani a giorno e piano in alluminio pressofuso. Prese elettriche (tipo schuko) disponibili su richiesta. Altre finiture a scelta.

Structure in white melamine, with open compartments and die-cast aluminum top. Electric sockets (schuko type) available on request. Other finishes available.

Structure en mélamine blanche, avec compartiments ouverts et plateau en aluminium moulé sous pression. Prises électriques (type schuko) disponibles sur demande. Autres finitions disponibles.

Struktur in weißem Melamin, mit offenen Fächern und Aluminium-Druckguss-Top. Steckdosen (Schuko-Typ) auf Anfrage erhältlich. Andere Ausführungen verfügbar.

Estructura en melamina blanca, con compartimentos abiertos y estante de aluminio fundido a presión. Enchufes eléctricos (tipo schuko) disponibles en opción. Otros acabados disponibles.

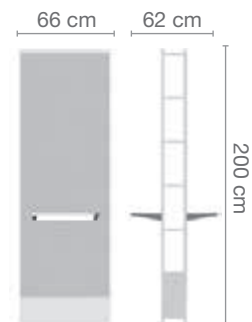



G9806B

FAIR P

Struttura in nobilitato bianco. Altre finiture a scelta.

Structure in white melamine. Other finishes available.

Structure en mélamine blanche. Autres finitions disponibles.

Struktur in weißem Melamin. Andere Ausführungen verfügbar.

Estructura en melamina blanca. Otros acabados disponibles.

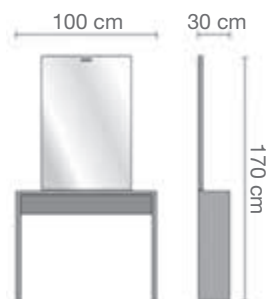

G9806S





G9807B



G9807S

FAIR 2P

Struttura in nobilitato bianco. Altre finiture a scelta.

Structure in white melamine. Other finishes available.

Structure en mélamine blanche. Autres finitions disponibles.

Struktur in weißem Melamin. Andere Ausführungen verfügbar.

Estructura en melamina blanca. Otros acabados disponibles.

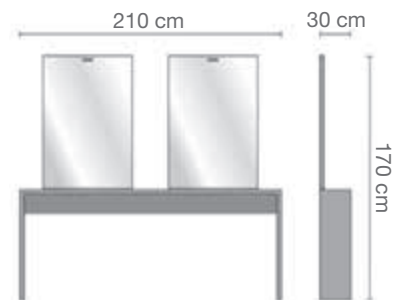



G9808S

FAIR 2C

Struttura in nobilitato bianco. Specchio bifacciale con vani a giorno o specchi da tavolo. Altre finiture a scelta.

Structure in white melamine. Double-sided mirror with open compartments or table mirrors. Other finishes available.

Structure en mélamine blanche. Miroir à double face avec des compartiments ouverts ou des miroirs de table. Autres finitions disponibles.

Struktur in weißem Melamin. Doppelseitiger Spiegel mit offenen Fächern oder Tischspiegeln. Andere Ausführungen verfügbar.

Estructura en melamina blanca. Espejo de doble cara con compartimentos abiertos o espejos de mesa. Otros acabados disponibles.

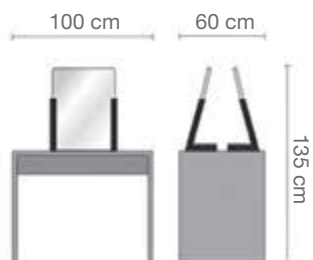
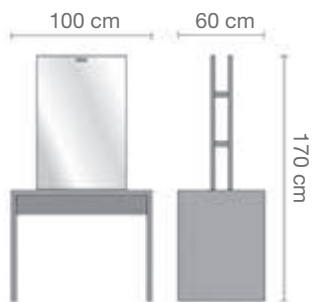

G9808BCM



G9812SCM



G9812B

FAIR 4C

Struttura in nobilitato bianco. Specchio bifacciale con vani a giorno o specchi da tavolo. Altre finiture a scelta.

Structure in white melamine. Double-sided mirror with open compartments or table mirrors. Other finishes available.

Structure en mélamine blanche. Miroir à double face avec des compartiments ouverts ou des miroirs de table. Autres finitions disponibles.

Struktur in weißem Melamin. Doppelseitiger Spiegel mit offenen Fächern oder Tischspiegeln. Andere Ausführungen verfügbar.

Estructura en melamina blanca. Espejo de doble cara con compartimentos abiertos o espejos de mesa. Otros acabados disponibles.

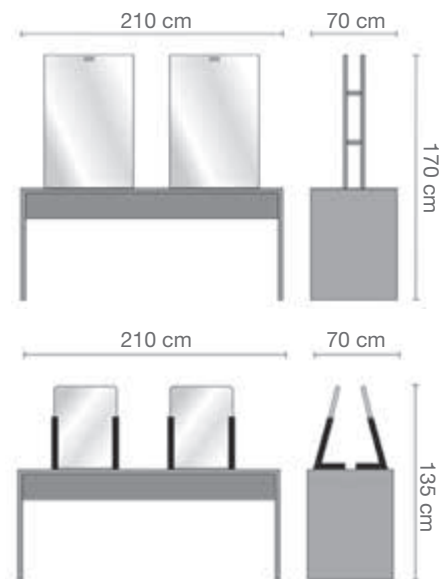

JILL

Cornice in alluminio. Piano in alluminio pressofuso lucidato e brillantato.

Aluminium frame. Worktop in die-cast polished aluminium.

Cadre en aluminium. Top en aluminium moulé sous pression et poli.

Aluminiumrahmen. Arbeitsplatte aus Aluminiumdruckguss.

Cornisa de aluminio. Estante en aluminio fundido a presión y pulido.

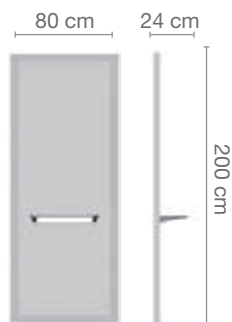



JILL LIGHT

Cornice in alluminio. Piano in alluminio pressofuso lucidato e brillantato. Completo di illuminazione LED.

Aluminium frame. Worktop in die-cast polished aluminium. With LED lighting.

Cadre en aluminium. Top en aluminium moulé sous pression et poli. Avec éclairage LED.

Aluminiumrahmen. Arbeitsplatte aus Aluminiumdruckguss. Mit LED-Beleuchtung.

Cornisa de aluminio. Estante en aluminio fundido a presión y pulido. Con iluminación LED.

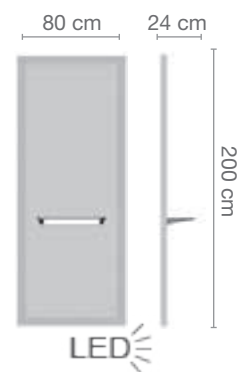

EKO S

Struttura in nobilitato con pianetto in vetro su sostegni in alluminio. Finiture a scelta.

Structure in melamine with glass shelf on aluminum supports. Wide range of finishes available.

Structure en mélamine avec étagère en verre sur des supports en aluminium. Large gamme de finitions disponibles.

Struktur in Melamin mit Glasboden auf Aluminiumstützen. Breite Palette von Ausführungen verfügbar.

Estructura en melamina con estante de vidrio sobre soportes de aluminio. Amplia gama de acabados disponibles.



G9813N

G9813S



G9814

EKO S-SOFT

Struttura in nobilitato rivestito di skai con colori a scelta. Pianetto in vetro su sostegni in alluminio.

Structure in melamine covered with skai with colors of your choice. Glass shelf on aluminum supports.

Structure en mélamine recouverte de skai en couleurs à choisir. Étagère en verre sur des supports en aluminium.

Struktur in Melamin mit Skai bedeckt (Farben Ihrer Wahl). Glasboden auf Aluminiumstützen.

Estructura en melamina recubierta de skai con colores a elección. Estante de vidrio sobre soportes de aluminio.





EKO S-LIGHT

Struttura in nobilitato con pianetto in vetro su sostegni in alluminio. Finiture a scelta. Completo di illuminazione LED.

Structure in melamine with glass shelf on aluminum supports. Wide range of finishes available. With LED lighting.

Structure en mélamine avec étagère en verre sur des supports en aluminium. Large gamme de finitions disponibles. Avec éclairage LED.

Struktur in Melamin mit Glasboden auf Aluminiumstützen. Breite Palette von Ausführungen verfügbar. Mit LED-Beleuchtung.

Estructura en melamina con estante de vidrio sobre soportes de aluminio. Amplia gama de acabados disponibles. Con iluminación LED.

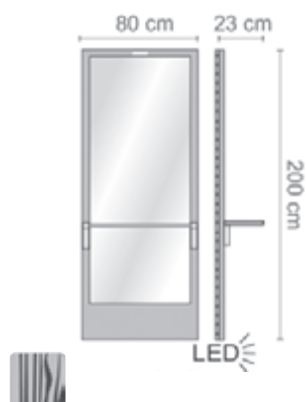

G9813SL



G9813NF

G9813SF

EKO S-FULL

Struttura in legno nobilitato con pianetto in vetro su sostegni in alluminio. Specchio incollato. Finiture nobilitato a scelta. Supporto retrostante con vani a giorno. Optional retroilluminazione a led.

Structure in melamine with glass shelf on aluminum supports. Wide range of finishes available. Supporting shelf with open compartments. LED backlighting available on request.

Structure en mélamine avec étagère en verre sur des supports en aluminium. Large gamme de finitions disponibles. Rétro-éclairage LED disponible sur demande.

Struktur in Melamin mit Glasboden auf Aluminiumstützen. Breite Palette von Ausführungen verfügbar. LED-Hintergrundbeleuchtung auf Anfrage erhältlich.

Estructura en melamina con estante de vidrio sobre soportes de aluminio. Amplia gama de acabados disponibles. Retroiluminación LED disponible en opción.





BOX

Struttura in legno di rovere laminato. Cassetti in legno laminato e vano a giorno. Finiture a scelta.

Structure in laminated oak wood. Drawers in laminated wood and open compartment. Wide range of finishes available.

Structure en bois de chêne stratifié. Tiroirs en bois laminé et compartiment ouvert. Large gamme de finitions disponibles.

Struktur aus laminiertem Eichenholz. Schubladen aus Schichtholz und offenes Fach. Breite Palette von Ausführungen verfügbar.

Estructura en madera laminada de roble. Cajones en madera laminada y compartimento abierto. Amplia gama de acabados disponibles.



G9874





G9877

SQUARED

Specchio con accessori compresi.

Mirror with accessories included.

Miroir avec accessoires compris.

Spiegel mit Zubehör enthalten.

Espejo con accesorios incluidos.

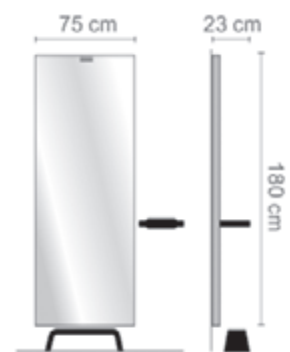



TYPE 9915



CLIP 9918



B-TYPE 9916



B-CLIP 9919

TYPE e CLIP

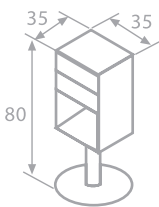
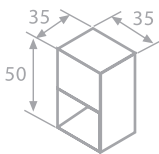
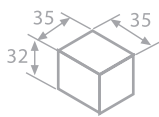

in cm.



S-TYPE 9914



S-CLIP 9917

PIANETTI



9803



9801

PORTA PHON

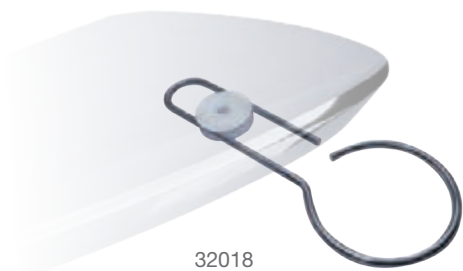

32018



32019



32017

ACCESSORI

POGGIAPIEDI



9705



9701



9706





POLTRONCINE

Chairs

LEIDY SUPERIOR pag 50

ALLY pag 52

FRAC pag 53

CLOUD pag 54

OLIVIA pag 56

GAIA pag 58

LULÙ pag 60

VERUSKA pag 61

LARA pag 62

LARA CONFORT pag 63

EMMA pag 64

ASYA pag 65

CAROL pag 66

FLEX pag 67

AMBIENTE HELSINKI pag 68

MARTINA pag 70

CLASS pag 71

ASTRID pag 72

NICOL pag 73

MARICA pag 74

SOFIA pag 75

ZOE pag 76

KARMA pag 77

EVA pag 78

GIORGIA pag 79

TAO pag 80

JINNY pag 81

TOM&JERRY pag 82

BASI pag 83

BOSTON



P405306CH RIF. 6

LEIDY SUPERIOR



P405306 RIF. 6

Schienale, seduta e braccioli in poliuretano schiumato con inserti in metallo e legno multistrato. Rivestimenti skai a scelta. Base girevole in alluminio con pompa idraulica e freno. Poggiatesta e schienale reclinabile e alzagambe incluso.

Backrest, seat and armrests in polyurethane foam on metal and multilayer wooden structure. Skai upholstery of your choice. Aluminium base, with swivel mechanism, hydraulic pump and brake. Reclining backrest, headrest and footrest included.

Dossier, assise et bras en mousse de polyuréthane avec des parties en bois multicouche et métal. Revêtement en skai à choisir. Bases pivotantes en aluminium, avec pompe hydraulique et frein. Dossier reclinable, repose-tête et repose-pied incluses.

Rückenlehne, Sitz und Armlehnen aus Polyurethan Schaum auf Metall und Holzstruktur. Breite skai Farbpalette verfügbar. Aluminiumfuß mit Schwenkmechanismus oder mit hydraulisch arretierbarer Pumpe. Liegende Rückenlehne, Kopfstütze und Fußstütze inbegriffen.

Respaldo, asiento y apoyabrazos de poliuretano espumado con estructura de metal y multicapa de madera. Revestimientos skai a elección. Bases de aluminio giratoria, con bomba hidráulica y freno. Apoyacabeza y respaldo reclinable; levantapiernas incorporado.

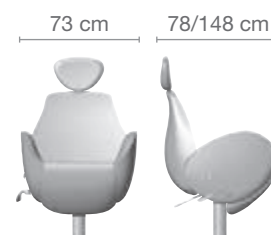



ALLY

Schienale, seduta e braccioli in poliuretano schiumato con inserti in legno multistrato. Supporti in alluminio pressofuso, lucidato e satinato. Rivestimenti skai a scelta. Base girevole in alluminio o con pompa idraulica e freno.

Backrest, seat and armrests in polyurethane foam on multilayer wooden structure. Supports of die-cast aluminium, polished and satin. Skai upholstery of your choice. Aluminium base with swivel mechanism or hydraulic pump and brake.

Dossier, assise et bras en mousse de polyuréthane avec des parties en bois multicouche. Supports en aluminium moulé sous pression, poli et givré. Revêtement en skai à choisir. Bases en aluminium pivotantes ou avec pompe hydraulique et frein.

Rückenlehne, Sitz und Armlehnen aus Polyurethan Schaum auf Holzstruktur. Stützen aus Aluminium-Druckguss, poliert und satiniert.

Breite skai Farbpalette verfügbar. Aluminiumfuß mit Schwenkmechanismus oder mit hydraulisch arretierbarer Pumpe.

Respaldo, asiento y apoyabrazos de poliuretano espumado con estructura de multicapa de madera. Soportes de aluminio fundido a presión, pulido y satinado. Revestimientos skai a elección. Bases de aluminio giratoria o con bomba hidráulica y freno.

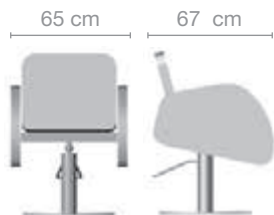

G409206 RIF. 6



G409205 RIF. 5



FRAC

Schienale, seduta e braccioli in poliuretano schiumato con inserti in metallo e legno multistrato. Rivestimenti skai a scelta. Base girevole in alluminio o con pompa idraulica e freno.

Backrest, seat and armrests in polyurethane foam on metal and multilayer wooden structure. Skai upholstery of your choice. Aluminium base with swivel mechanism or hydraulic pump and brake.

Dossier, assise et bras en mousse de polyuréthane avec des parties en bois multicouche et métal.

Revêtement en skai à choisir. Bases en aluminium pivotantes ou avec pompe hydraulique et frein.

Rückenlehne, Sitz und Armlehnen aus Polyurethan Schaum auf Metall und Holzstruktur. Breite skai Farbpalette verfügbar. Aluminiumfuß mit Schwenkmechanismus oder mit hydraulisch arretierbarer Pumpe.

Respaldo, asiento y apoyabrazos de poliuretano espumado con estructura de metal y multicapa de madera. Revestimientos skai a elección. Bases de aluminio giratoria o con bomba hidráulica y freno.



P409105 RIF. 5

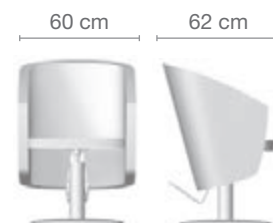



P408106 RIF. 6

CLOUD



Scocca in poliuretano schiumato con doppio inserto in poliuretano rigido. Rivestimenti skai a scelta. Base girevole in alluminio o con pompa idraulica con freno.

Polyuréthane foam body with double rigid polyuréthane insert. Skai upholstery of your choice. Aluminium base, with swivel mechanism or with hydraulic pump and brake.

Coque en mousse de polyurethane avec double insert en polyurethane rigide. Revêtement skai à choisir. Bases pivotantes en aluminium ou avec pompe hydraulique avec frein.

Struktur des Polyurethanschaums mit doppelter steifer Einfügung. Breite skai Farbpalette verfügbar. Aluminiumfuß mit Schwenkmechanismus oder mit hydraulisch arretierbarer Pumpe.

Estructura de espuma de poliuretano con doble inserción rígida. Revestimientos skai a elección. Bases de aluminio giratorias o con bomba hidráulica y freno.

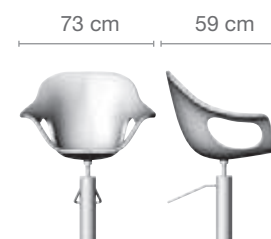



OLIVIA

Schienale e seduta in poliuretano schiumato con inserti in legno. Rivestimenti skai a scelta. Base girevole in alluminio o con pompa idraulica e freno.

Seat and backrest in polyurethane foam on a wooden structure. Skai upholstery of your choice. Aluminium base, with swivel mechanism or with hydraulic pump and brake.

Dossier et assise en mousse de polyuréthane avec des parties en bois. Revêtement en skai à choisir. Bases pivotantes en aluminium ou avec pompe hydraulique et frein.

Sitz und Rückenlehne aus Polyurethanschaum auf Holzchassis. Breite skai Farbpalette verfügbar. Aluminiumfuß mit Schwenkmechanismus oder mit hydraulisch arretierbarer Pumpe.

Respaldo y asiento de poliuretano espumado con estructura de madera. Revestimientos skay a elección. Bases de aluminio giratoria o con bomba hidráulica y freno.

68 cm 63 cm



P410005 RIF. 5



P410006 RIF. 6



OLIVIA MAKE-UP

Schienale e seduta in poliuretano schiumato con inserti in legno. Rivestimenti skai a scelta. Base girevole in alluminio o con pompa idraulica con fren. Poggiatesta regolabile e poggia-piedi.

Seat and backrest in polyurethane foam on a wooden structure. Skai upholstery of your choice. Aluminium base, with swivel mechanism or with hydraulic pump and brake. Adjustable head support and footrest.

Dossier et assise en mousse de polyuréthane avec des parties en bois. Revêtement en skai à choisir. Bases pivotantes en aluminium ou avec pompe hydraulique et frein. Repose-tête réglable et repose-pied.

Sitz und Rückenlehne aus Polyurethanschaum auf Holzchassis. Breite skai Farbpalette verfügbar. Aluminiumfuß mit Schwenkmechanismus oder mit hydraulisch arretierbarer Pumpe. Verstellbare Kopfstütze und Fußstütze.

Respaldo y asiento de poliuretano espumado con estructura de madera. Revestimientos skay a elección. Bases de aluminio giratoria o con bomba hidráulica y freno. Apoyacabeza ajustable y soportes apoyapiés.



P410006ATAP RIF. 6





GAIA

Schienale e seduta in poliuretano schiumato con inserti in legno. Rivestimenti skai a scelta. Base girevole in alluminio o con pompa idraulica e freno.

Seat and backrest in polyurethane foam on a wooden structure. Skai upholstery of your choice. Aluminium base, with swivel mechanism or with hydraulic pump and brake.

Dossier et assise en mousse de polyuréthane avec des parties en bois. Revêtement en skai à choisir. Bases pivotantes en aluminium ou avec pompe hydraulique et frein.

Sitz und Rückenlehne aus Polyurethanschaum auf Holzchassis. Breite skai Farbpalette verfügbar. Aluminiumfuß mit Schwenkmechanismus oder mit hydraulisch arretierbarer Pumpe.

Respaldo y asiento de poliuretano espumado con estructura de madera. Revestimientos skai a elección. Bases de aluminio giratoria o con bomba hidráulica y freno.

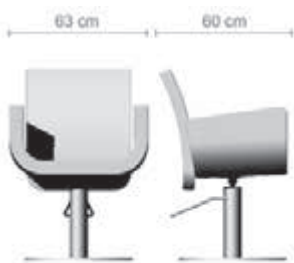

G410205 RIF. 5



G410206 RIF. 6



P410106 RIF. 6



LULÙ

Schienale e seduta in poliuretano schiumato con inserti in legno. Rivestimenti skai a scelta. Base girevole in alluminio o con pompa idraulica e freno.

Seat and backrest in polyurethane foam on a wooden structure. Skai upholstery of your choice. Aluminium base, with swivel mechanism or with hydraulic pump and brake.

Dossier et assise en mousse de polyuréthane avec des parties en bois. Revêtement en skai à choisir. Bases pivotantes en aluminium ou avec pompe hydraulique et frein.

Sitz und Rückenlehne aus Polyurethanschaum auf Holzchassis. Breite skai Farbpalette verfügbar. Aluminiumfuß mit Schwenkmechanismus oder mit hydraulisch arretierbarer Pumpe.

Respaldo y asiento de poliuretano espumado con estructura de madera. Revestimientos skai a elección. Bases de aluminio giratoria o con bomba hidráulica y freno.

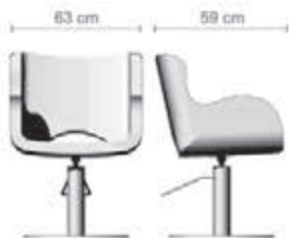

P410105 RIF. 5





VERUSKA

Monoscocca in poliuretano schiumato con inserti in metallo. Rivestimenti skai a scelta. Base girevole in alluminio o con pompa idraulica e freno.

Polyurethane foam monocoque with metal structure. Skai upholstery of your choice. Aluminium base with swivel mechanism or with hydraulic pump and brake.

Monocoque de polyuréthane avec des parties en métal.
 Revêtement en skai à choisir. Bases en aluminium pivotantes ou avec pompe hydraulique et frein.

Polyurethanschaum-Monocoque mit Metallstruktur. Breite skai Farbpalette verfügbar. Aluminiumfuß mit Schwenkmechanismus oder mit hydraulisch arretierbarer Pumpe.

Monocasco de espuma de poliuretano con estructura metálica. Revestimientos skai a elección. Base de aluminio giratoria o con bomba hidráulica y freno.

P408505 RIF. 5





G409606B RIF. 6



G409606T RIF. 6

LARA

Monoscocca in polipropilene o policarbonato stampata ad iniezione. Base in alluminio girevole o con pompa idraulica e freno.

Polycarbonate or polypropylene monocoque, made by injection molding. Aluminium base with swivel mechanism or with hydraulic pump and brake.

Monocoque en polycarbonate ou en polypropylène moulée par injection. Bases en aluminium pivotantes ou avec pompe hydraulique et frein.

Polycarbonat oder Polypropylen-Monocoque, im Spritzgussverfahren hergestellt. Aluminiumfuß mit Schwenkmechanismus oder mit hydraulisch arretierbarer Pumpe.

Monocasco de polipropileno o policarbonato hecho a inyección. Bases de aluminio giratoria o con bomba hidráulica y freno.

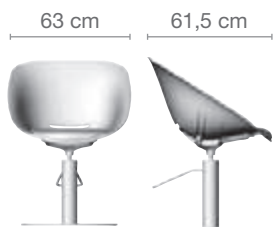

Colori / Colours



G409605N RIF. 5



G409606TC RIF. 6



G409605NC RIF. 5

LARA confort

Monoscocca in polipropilene o policarbonato stampata ad iniezione. Cuscino in poliuretano schiumato con inserto in legno multistrato. Rivestimenti skai a scelta. Base in alluminio girevole o con pompa idraulica e freno.

Polycarbonate or polypropylene monocoque, made by injection molding. Foamed polyurethane cushion with multilayer wood insert. Skai upholstery of your choice. Aluminium base with swivel mechanism or with hydraulic pump and brake.

Monocoque en polycarbonate ou en polypropylène moulée par injection. Coussin en mousse de polyuréthane avec insert en bois multicouche. Revêtement en skai à choisir. Bases en aluminium pivotantes ou avec pompe hydraulique et frein.

Polycarbonat oder Polypropylen-Monocoque, im Spritzgussverfahren hergestellt. Geschäumtes Polyurethankissen mit mehrlagigem Holzeinsatz. Breite skai Farbpalette verfügbar. Aluminiumfuß mit Schwenkmechanismus oder mit hydraulisch arretierbarer Pumpe.

Monocasco de polipropileno o policarbonato hecho a inyección. Cojín de espuma de poliuretano con inserción de madera multicapa. Revestimientos skai a elección. Bases de aluminio giratoria o con bomba hidráulica y freno.



G409606BC RIF. 6

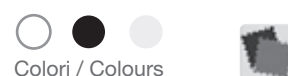
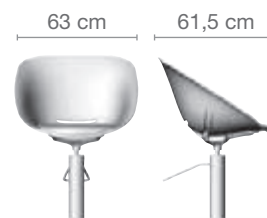

Colori / Colours



EMMA

Schienale e seduta in poliuretano schiumato con inserti in legno. Rivestimenti skai a scelta. Base girevole in alluminio o con pompa idraulica e freno.

Seat and backrest in polyurethane foam on a wooden structure. Skai upholstery of your choice. Aluminium base, with swivel mechanism or with hydraulic pump and brake.

Dossier et assise en mousse de polyuréthane avec des parties en bois. Revêtement en skai à choisir. Bases pivotantes en aluminium ou avec pompe hydraulique et frein.

Sitz und Rückenlehne aus Polyurethanschaum auf Holzchassis. Breite skai Farbpalette verfügbar. Aluminiumfuß mit Schwenkmechanismus oder mit hydraulisch arretierbarer Pumpe.

Respaldo y asiento de poliuretano espumado con estructura de madera. Revestimientos skai a elección. Bases de aluminio giratoria o con bomba hidráulica y freno.

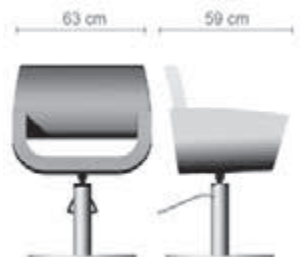

P410306 RIF. 6



P410305 RIF. 5



G408405 RIF. 5

ASYA

Monoscocca in poliuretano schiumato con inserti in metallo. Rivestimenti skai a scelta. Base girevole in alluminio o con pompa idraulica e freno.

Polyurethane foam monocoque with metal structure. Skai upholstery of your choice. Aluminium base with swivel mechanism or with hydraulic pump and brake.

Monocoque de polyuréthane avec des parties en métal. Revêtement en skai à choisir. Bases en aluminium pivotantes ou avec pompe hydraulique et frein.

Polyurethanschaum-Monocoque mit Metallstruktur. Breite skai Farbpalette verfügbar. Aluminiumfuß mit Schwenkmechanismus oder mit hydraulisch arretierbarer Pumpe.

Monocasco de espuma de poliuretano con estructura metálica. Revestimientos skai a elección. Base de aluminio giratoria o con bomba hidráulica y freno.



G408406 RIF. 6

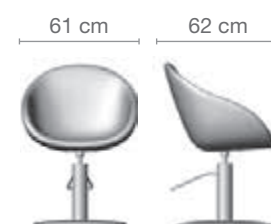



P410405 RIF. 5

CAROL

Schienale e seduta in poliuretano schiumato con inserti in legno. Rivestimenti skai a scelta. Base girevole in alluminio o con pompa idraulica e freno.

Seat and backrest in polyurethane foam on a wooden structure. Skai upholstery of your choice. Aluminium base, with swivel mechanism or with hydraulic pump and brake.

Dossier et assise en mousse de polyuréthane avec des parties en bois. Revêtement en skai à choisir. Bases pivotantes en aluminium ou avec pompe hydraulique et frein.

Sitz und Rückenlehne aus Polyurethanschaum auf Holzchassis. Breite skai Farbpalette verfügbar. Aluminiumfuß mit Schwenkmechanismus oder mit hydraulisch arretierbarer Pumpe.

Respaldo y asiento de poliuretano espumado con estructura de madera. Revestimientos skai a elección. Bases de aluminio giratoria o con bomba hidráulica y freno.



P410406 RIF. 6





P409306 RIF. 6

FLEX

Schienale e seduta in poliuretano schiumato con inserti in legno multistrato e metallo. Rivestimenti skai a scelta. Base girevole in alluminio o con pompa idraulica e freno. **CLUB HOUSE:** Pezzi unici fatti a mano con dettagli che fanno la differenza. Dettagli raffinati, pregiate finiture e naturalmente bellezza estetica ne fanno esemplari unici.

Seat and backrest in polyurethane foam on a metal and multilayer wood structure. Skai upholstery of your choice. Aluminium base, with swivel mechanism or with hydraulic pump and brake.

CLUB HOUSE: Unique handmade pieces with details that make the difference. Crafted seams, refined details and prestigious finishes they transform each chair in a unique piece.

Dossier et assise en mousse de polyuréthane avec des parties en bois multicouche et métal. Revêtement en skai à choisir. Bases pivotantes en aluminium ou avec pompe hydraulique et frein.

CLUB HOUSE: Des pièces uniques faites à la main avec des détails qui font la différence. Coutures travaillées, détails raffinés et finitions prestigieuses, ils transforment chaque chaise en une pièce unique.

Sitz und Rückenlehne aus Polyurethanschaum auf Metall und mehrschichtigem Holzchassis. Breite skai Farbpalette verfügbar. Aluminiumfuß mit Schwenkmechanismus oder mit hydraulisch arretierbarer Pumpe.

CLUB HOUSE: Einzigartige handgefertigte Stücke mit Details, die den Unterschied ausmachen. Gearbeitete Nähte, raffinierte Details und repräsentative Oberflächen machen jeden Stuhl zu einem Unikat.

Respaldo, asiento y apoyabrazos de poliuretano espumado con estructura de madera multistrato. Revestimientos skay a elección. Bases de aluminio giratoria o con bomba hidráulica y freno.

CLUB HOUSE: Piezas artesanales únicas con detalles que marcan la diferencia. Costuras elaboradas, detalles refinados y acabados de prestigio transforman cada silla en una pieza única.



P409306CB RIF. 6







HELSINKI



MARTINA

Schienale e seduta in poliuretano schiumato con inserti in legno. Rivestimenti skai a scelta. Base girevole in alluminio o con pompa idraulica e freno.

Seat and backrest in polyurethane foam on a wooden structure. Skai upholstery of your choice. Aluminium base with swivel mechanism or with hydraulic pump and brake.

Dossier et assise en mousse de polyuréthane avec des parties en bois. Revêtement en skai à choisir. Bases pivotantes en aluminium ou avec pompe hydraulique et frein.

Sitz und Rückenlehne aus Polyurethanschaum auf einem Holzchassis. Breite skai Farbpalette verfügbar. Aluminiumfuß mit Schwenkmechanismus oder mit hydraulisch arretierbarer Pumpe.

Respaldo y asiento de poliuretano espumado con estructura de madera. Revestimientos skay a elección. Bases de aluminio giratoria o con bomba hidráulica y freno.



G409405 RIF. 5



G409406 RIF. 6



G409005 RIF. 5



G409006 RIF. 6



G409009 RIF. 9

CLASS

Schienale, seduta e braccioli in poliuretano schiumato con inserti in metallo e legno multistrato. Supporti in alluminio pressofuso, lucidato e satinato. Rivestimenti skai a scelta. Base girevole in alluminio o con pompa idraulica e freno.

Backrest, seat and armrests in polyurethane foam on metal and multilayer wooden structure. Supports of die-cast aluminum, polished and satin. Skai upholstery of your choice. Aluminium base with swivel mechanism or hydraulic pump and brake.

Dossier, assise et bras en mousse de polyuréthane avec des parties en bois multicouche et métal. Supports en aluminium moulé sous pression, poli et gravé. Revêtement en skai à choisir. Bases en aluminium pivotantes ou avec pompe hydraulique et frein.

Rückenlehne, Sitz und Armlehnen aus Polyurethan Schaum auf Metall und Holzstruktur. Stützen aus Aluminium-Druckguss, poliert und satiniert. Breite skai Farbpalette verfügbar. Aluminiumfuß mit Schwenkmechanismus oder mit hydraulisch arretierbarer Pumpe.

Respaldo, asiento y apoyabrazos de poliuretano espumado con estructura de metal y multicapa de madera. Soportes de aluminio fundido a presión, pulido y satinado. Revestimientos skai a elección. Bases de aluminio giratoria o con bomba hidráulica y freno.

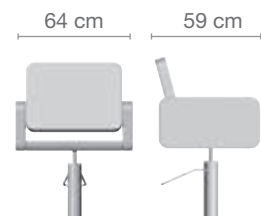



ASTRID

Schienale e seduta in poliuretano schiumato con inserti in legno. Rivestimenti skai a scelta. Base girevole in alluminio o con pompa idraulica e freno.

Seat and backrest in polyurethane foam on a wooden structure. Skai upholstery of your choice. Aluminium base, with swivel mechanism or with hydraulic pump and brake.

Dossier et assise en mousse de polyuréthane avec des parties en bois. Revêtement en skai à choisir. Bases pivotantes en aluminium ou avec pompe hydraulique avec frein.

Sitz und Rückenlehne aus Polyurethanschaum auf Holzchassis. Breite skai Farbpalette verfügbar. Aluminiumfuß mit Schwenkmechanismus oder mit hydraulisch arretierbarer Pumpe.

Respaldo y asiento de poliuretano espumado con estructura de madera. Revestimientos skay a elección. Bases de aluminio giratoria o con bomba hidráulica y freno.



G410505 RIF. 5



G410506 RIF. 6



P409506 RIF- 6



NICOL

Monoscocca in poliuretano schiumato con inserti in polipropilene. Rivestimenti skai a scelta. Base girevole in alluminio o con pompa idraulica e freno.

Polyurethane foam monocoque with polypropylene structure. Skai upholstery of your choice. Aluminium base with swivel mechanism or with hydraulic pump and brake.

Monocoque de polyuréthane avec structure en polypropylène. Revêtement en skai à choisir. Bases en aluminium pivotantes ou avec pompe hydraulique et frein.

Polyurethanschaum-Monocoque mit Polypropylenstruktur. Breite skai Farbpalette verfügbar. Aluminiumfuß mit Schwenkmechanismus oder mit hydraulisch arretierbarer Pumpe.

Monocasco de espuma de poliuretano con estructura de polipropileno. Revestimientos skai a elección. Base de aluminio giratoria o con bomba hidráulica y freno.



P409505 RIF. 5

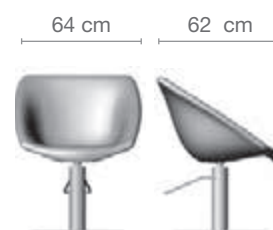



G410605 RIF. 5

MARICA

Schienale e seduta in poliuretano schiumato con inserti in legno. Rivestimenti skai a scelta. Base girevole in alluminio o con pompa idraulica e freno.

Seat and backrest in polyurethane foam on a wooden structure. Skai upholstery of your choice. Aluminium base, with swivel mechanism or with hydraulic pump and brake.

Dossier et assise en mousse de polyuréthane avec des parties en bois. Revêtement en skai à choisir. Bases pivotantes en aluminium ou avec pompe hydraulique et frein.

Sitz und Rückenlehne aus Polyurethanschaum auf Holzchassis. Breite skai Farbpalette verfügbar. Aluminiumfuß mit Schwenkmechanismus oder mit hydraulisch arretierbarer Pumpe.

Respaldo y asiento de poliuretano espumado con estructura de madera. Revestimientos skai a elección. Bases de aluminio giratoria o con bomba hidráulica y freno.



G410606 RIF. 6



G410709 RIF. 9

SOFIA

Schienale e seduta in poliuretano schiumato con inserti in legno. Rivestimenti skai a scelta. Base girevole in alluminio o con pompa idraulica e freno.

Seat and backrest in polyurethane foam on a wooden structure. Skai upholstery of your choice. Aluminium base, with swivel mechanism or with hydraulic pump and brake.

Dossier et assise en mousse de polyuréthane avec des parties en bois. Revêtement en skai à choisir. Bases pivotantes en aluminium ou avec pompe hydraulique et frein.

Sitz und Rückenlehne aus Polyurethanschaum auf einem Holzchassis. Breite skai Farbpalette verfügbar. Aluminiumfuß mit Schwenkmechanismus oder mit hydraulisch arretierbarer Pumpe.

Respaldo y asiento de poliuretano espumado con estructura de madera. Revestimientos skay a elección. Bases de aluminio giratoria o con bomba hidráulica y freno.



G410705 RIF. 5

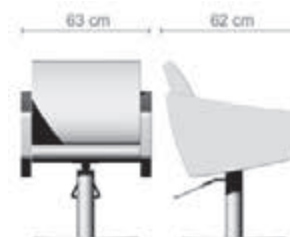



ZOE

Schienale e seduta in poliuretano schiumato con inserti in legno. Braccioli in alluminio pressofuso lucidato e satinato. Rivestimenti skai a scelta. Base girevole in alluminio o con pompa idraulica e freno.

Seat and backrest in polyurethane foam on a wooden structure. Armrests in die-cast aluminium, polished and satin. Skai upholstery of your choice. Aluminium base, with swivel mechanism or with hydraulic pump and brake.

Dossier et assise en mousse de polyuréthane avec des parties en bois. Revêtement en skai à choisir. Bases pivotantes en aluminium ou avec pompe hydraulique avec frein. Bras en aluminium moulé sous pression poli e satiné.

Sitz und Rückenlehne aus Polyurethanschaum auf Holzchassis. Breite skai Farbpalette verfügbar. Aluminiumfuß mit Schwenkmechanismus oder mit hydraulisch arretierbarer Pumpe. Armlehne aus Aluminium-Druckguss, poliert und satiniert.

Respaldo y asiento de poliuretano espumado con estructura de madera. Revestimientos skay a elección. Bases de aluminio giratoria o con bomba hidráulica y freno. Apoyabrazos de aluminio fundido a presión pulido y satinado.

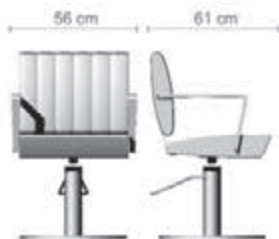

G410806 RIF. 6



G410805 RIF. 5



G404609 RIF. 9



KARMA

Schienale e seduta in poliuretano schiumato con inserti in legno. Rivestimenti skai a scelta. Base girevole in alluminio o con pompa idraulica e freno.

Seat and backrest in polyurethane foam on a wooden structure. Skai upholstery of your choice. Aluminium base with swivel mechanism or with hydraulic pump and brake.

Dossier et assise en mousse de polyuréthane avec des parties en bois. Revêtement en skai à choisir. Bases pivotantes en aluminium ou avec pompe hydraulique et frein.

Sitz und Rückenlehne aus Polyurethanschaum auf einem Holzchassis. Breite skai Farbpalette verfügbar. Aluminiumfuß mit Schwenkmechanismus oder mit hydraulisch arretierbarer Pumpe.

Respaldo y asiento de poliuretano espumado con estructura de madera. Revestimientos skay a elección. Bases de aluminio giratoria o con bomba hidráulica y freno.



G404606 RIF. 6

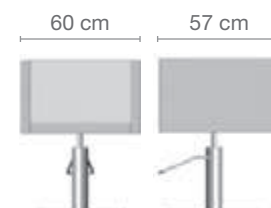



EVA

Schienale e seduta in poliuretano schiumato con inserti in legno. Rivestimenti skai a scelta. Base girevole in alluminio o con pompa idraulica e freno.

Seat and backrest in polyurethane foam on a wooden structure. Skai upholstery of your choice. Aluminium base with swivel mechanism or with hydraulic pump and brake.

Dossier et assise en mousse de polyuréthane avec des parties en bois. Revêtement en skai à choisir. Bases pivotantes en aluminium ou avec pompe hydraulique et frein.

Sitz und Rückenlehne aus Polyurethanschaum auf einem Holzchassis. Breite skai Farbpalette verfügbar. Aluminiumfuß mit Schwenkmechanismus oder mit hydraulisch arretierbarer Pumpe.

Respaldo y asiento de poliuretano espumado con estructura de madera. Revestimientos skay a elección. Bases de aluminio giratoria o con bomba hidráulica y freno.



G408005 RIF. 5

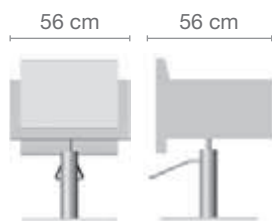



G406609 RIF. 9



GIORGIA

Schienale, seduta e braccioli in poliuretano schiumato con inserti in legno multistrato. Braccioli in alluminio pressofuso. Rivestimenti skai a scelta. Base girevole in alluminio o con pompa idraulica e freno.

Backrest, seat and armrests in polyurethane foam on multilayer wooden structure. Armrests in die-cast aluminium, polished and satin. Skai upholstery of your choice. Aluminium base with swivel mechanism or hydraulic pump and brake.

Dossier, assise et bras en mousse de polyuréthane avec des parties en bois multicouche. Accoudoirs en aluminium moulé sous pression, polis et givré. Revêtement en skai à choisir. Bases en aluminium pivotantes ou avec pompe hydraulique et frein.

Rückenlehne, Sitz und Armlehnen aus Polyurethan Schaum auf Holzstruktur. Armlehnen aus Aluminium-Druckguss, poliert und glasiert. Breite skai Farbpalette verfügbar. Aluminiumfuß mit Schwenkmechanismus oder mit hydraulisch arretierbarer Pumpe.

Respaldo, asiento y apoyabrazos de poliuretano espumado con estructura de multicapa de madera. Apoyabrazos en aluminio fundido a presión, pulido y satinado. Revestimientos skai a elección. Bases de aluminio giratoria o con bomba hidráulica y freno.



G406606 RIF. 6

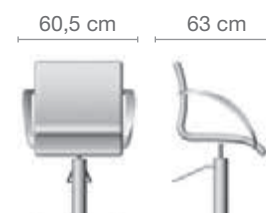



TAO

Pouff in poliuretano schiumato con inserti in legno multistrato. Rivestimenti skai a scelta. Pompa a gas e base girevole (in alluminio o plastica).

Stool made of polyurethane foam with wooden inserts. Wide skai colour range available. Gas pump and swivel base (in aluminium or plastic).

Tabouret en mousse de polyuréthane avec des inserts en bois. Revêtement en skai à choisir. Pompe à gaz avec base pivotante (en aluminium ou plastique).

Hocker aus Polyurethanschaum mit Holzeinsätzen. Breite Palette von Ausführungen verfügbar. Gasfeder mit Schwenkfuß (Aluminium oder Kunststoff).

Taburete de poliuretano espumado con estructura multicapa de madera. Revestimientos skai a elección. Bomba a gas y base giratoria (en aluminio o plástico).



P4911



P4916



G4915



G4913N



JINNI

Pouff in polipropilene o SAN stampato a iniezione. Pompa a gas e base girevole (in alluminio o plastica).

SAN or polypropylene stool, made by injection molding. Gas pump and swivel base (in aluminium or plastic).

Tabouret en polypropylène ou en SAN moulée par injection. Pompe à gaz avec base pivotante (en aluminium ou plastique).

Rollhocker aus Polypropylen oder SAN spritzgegossen. Gasfeder mit Schwenkfuß (Aluminium oder Kunststoff).

Taburete de polipropileno o SAN hecho a inyección. Bomba a gas y base giratoria (en aluminio o plástico).

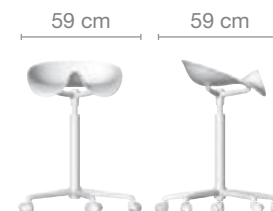



G4908

TOM&JERRY

TOM: pouff in poliuretano con inserti in legno e metallo.

JERRY: pouff in poliuretano con inserti in legno e metallo. Schienale in poliuretano con inserto in metallo. Pompa a gas e base girevole.

TOM: polyurethane stool with metal and wooden inserts.

JERRY: polyurethane stool with metal and wooden inserts. Backrest in polyurethane with metal insert. Gas pump and swivel base.

TOM: tabouret en polyuréthane avec des inserts en métal et en bois.

JERRY: tabouret en polyuréthane avec des inserts en métal et en bois. Dossier en polyuréthane avec insert métallique. Pompe à gaz et base pivotante.

TOM: Rollhocker aus Polyurethan auf Metall und Holzstruktur.

JERRY: Rollhocker aus Polyurethan auf Metall und Holzstruktur. Rückenlehne aus Polyurethan mit Metalleinsatz. Gasfeder mit Schwenkfuß.

TOM: taburete de poliuretano con estructura de metal y madera.

JERRY: taburete de poliuretano con estructura de metal y madera. Respaldo en poliuretano con inserto de metal. Bomba a gas y base giratoria.

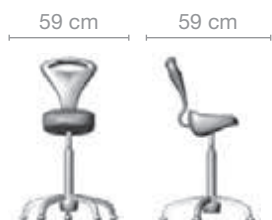

G4909



RIF. 16



RIF. 6



RIF. 15



RIF. 5



RIF. 19



RIF. 9

BASI

Basi in alluminio pressofuso, girevoli (rif. 15, rif. 16 e rif. 19) o con pompa idraulica e freno (rif. 5, rif. 6 e rif. 9).

Die-cast aluminium bases, swiveling (rif. 15, rif. 16 and rif. 19) or with hydraulic pump and brake (rif. 5, rif. 6 and rif. 9).

Bases en aluminium moulé sous pression, pivotantes (rif. 15, rif. 16 et rif. 19) ou avec pompe hydraulique et frein (rif. 5, rif. 6 et rif. 9).

Aluminium-Druckguss-Fuß, mit Schwenkmechanismus (rif. 15, rif. 16 und rif. 19) oder mit hydraulisch arretierbarer Pumpe (rif. 5, rif. 6 und rif. 9).

Bases de aluminio fundido a presión, giratorias (rif. 15, rif. 16 y rif. 19) o con bomba hidráulica y freno (rif. 5, rif. 6 y rif. 9).





POLTRONE UOMO

Men's Chairs

ACADEMY pag 86

PHON JUPITER pag 92

ELOGY BARBER pag 93

AMBIENTE DUBAI pag 94

JUPITER 388 pag 96

JUPITER 507 pag 106

KENT pag 108

OLIVER pag 109

ROYAL pag 110

STYLE pag 111

NEW YORK



ACADEMY



Struttura in nobilitato completa di cassetti, ante e vani a giorno. Colori laminato a scelta. Lavello in porcellana bianco o nero con miscelatore e doccia. Specchio con cornice.

Melamine structure with drawers, closet doors and open compartments. Laminate color at your choice. Basin in porcelain white or black with shower and mixer. Mirror with frame.

Structure en mélamine avec tiroir, casiers avec portes et compartiments ouverts. Couleurs laminé à choisir. Vasque en porcelaine blanche ou noire avec douche et mélangeur. Miroir avec cadre.

Struktur aus Melamin mit Schubladen, Schranktüren und offenen Fächern. Laminatfarbe nach Wahl. Becken aus weißem oder schwarzem Porzellan mit Mischbatterie und Handbrause. Spiegel mit Rahmen.

Esctructura de melamina con cajón, taquillas y compartimientos abiertos. Color de laminado a elección. Lavabo en porcelana blanco o negro con ducha y batidora. Espejo enmarcado.



ACADEMY



Struttura in nobilitato completa di cassetti, ante e vani a giorno. Colori laminato a scelta. Lavello in porcellana bianco o nero con miscelatore e doccetta. Specchio con cornice.

Melamine structure with drawers, closet doors and open compartments. Laminate color at your choice. Basin in porcelain white or black with shower and mixer. Mirror with frame.

Structure en mélamine avec tiroir, casiers avec portes et compartiments ouverts. Couleurs laminé à choisir. Vasque en porcelaine blanche ou noire avec douche et mélangeur. Miroir avec cadre.

Struktur aus Melamin mit Schubladen, Schranktüren und offenen Fächern. Laminatfarbe nach Wahl. Becken aus weißem oder schwarzem Porzellan mit Mischbatterie und Handbrause. Spiegel mit Rahmen.

Esctructura de melamina con cajón, taquillas y compartimientos abiertos. Color de laminado a elección. Lavabo en porcelana blanco o negro con ducha y batidora. Espejo enmarcado.

<p>N. COD. P9705 L. COD. P9706</p> <p>PENSILE ANTA/GIORNO WALL CABINET</p>	<p>N. COD. P9715 L. COD. P9716</p> <p>PENSILE MENSOLE SHELVES CABINET</p>	<p>N. COD. P9701 L. COD. P9702</p> <p>BASE CASSETTI/GIORNO BASE CABINET</p>	<p>N. COD. P9703 L. COD. P9704</p> <p>BASE LAVELLO INOX BASE CABINET INOX SINK</p>	<h3>COMPONENTI SINGOLI SINGLE ELEMENTS</h3> <p>N. COD. P9709 L. COD. P9710</p> <p>CONSOLE CENTRALE CENTRAL UNIT</p> <p>N. COD. P9707B L. COD. P9708B</p> <p>CONSOLE LAVELLO CERAMICA BIANCO CENTRAL UNIT WHITE CERAMIC BASIN</p> <p>N. COD. P9707N L. COD. P9708N</p> <p>CONSOLE LAVELLO CERAMICA NERO CENTRAL UNIT BLACK CERAMIC BASIN</p>
<p>FINITURA LEGNO WOOD TEXTURE</p>	<p>N. COD. P9711 L. COD. P9712</p> <p>SPECCHIO CORNICE FRAME MIRROR</p>	<p>COD. P9714</p> <p>SPECCHIO MEDIO MEDIUM MIRROR</p>	<p>COD. P9713</p> <p>SPECCHIO FULLSIZE FULL-SIZE MIRROR</p>	

SOLUZIONI SINGOLE SINGLE UNITS

<p>Comp. B1</p> <p>LxPxH cm. 190x40x220 WxHxD cm. 190x220x40</p>	<p>Comp. B2</p> <p>LxPxH cm. 190x40x220 WxHxD cm. 190x220x40</p>	<p>Comp. C1</p> <p>LxPxH cm. 190x40x210 WxHxD cm. 190x210x40</p>	<p>Comp. C2</p> <p>LxPxH cm. 190x40x210 WxHxD cm. 190x210x40</p>	<p>Comp. C3</p> <p>LxPxH cm. 190x57x210 WxHxD cm. 190x210x57</p>
		<p>Comp. D1</p> <p>LxPxH cm. 190x40x175 WxHxD cm. 190x175x40</p>	<p>Comp. D2</p> <p>LxPxH cm. 190x40x175 WxHxD cm. 190x175x40</p>	<p>Comp. D3</p> <p>LxPxH cm. 190x57x175 WxHxD cm. 190x175x57</p>

**SOLUZIONI SINGOLE
SINGLE UNITS**

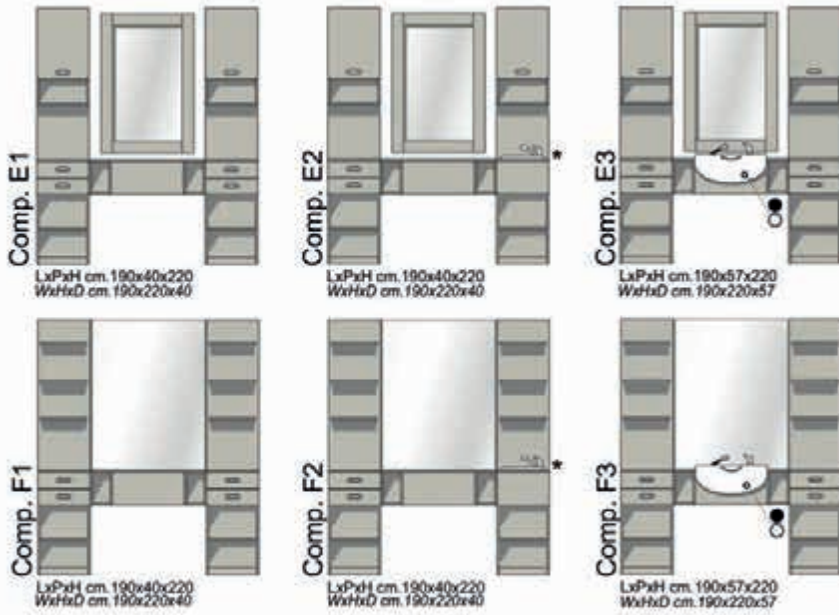

**SOLUZIONI MULTIPLE
MULTIPLE UNITS**

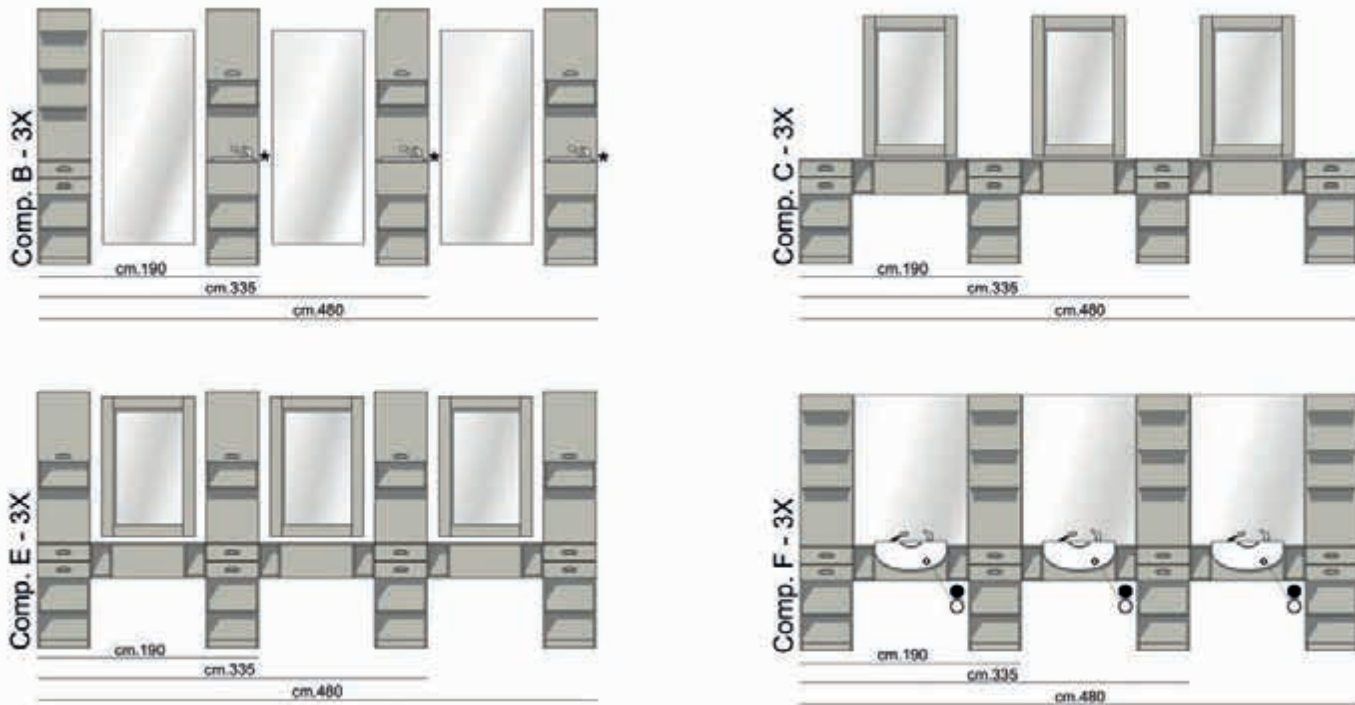



Espressione di Originalità Italiana



JUPITER

Phon dedicato e studiato per il mondo Barber. Quando è utilizzato in modalità "Barber" l'aria e la temperatura sono perfettamente calibrate per gestire e rispettare barba e baffi. Nell'utilizzo normale ritroviamo le consuete prestazioni professionali dei phon Ceriotti. Il design ed il colore "bronzo" donano al tuo salone un tocco personale e professionale.

Hairdryer dedicated and designed for the Barber world. When used in "Barber" mode, air and temperature are perfectly calibrated to handle and respect beard and moustache. In normal use, you can find the usual professional performance of every Ceriotti's hairdryer. The design and "bronze" colour give your salon a personal and professional touch.

Sèche-cheveux dédié et conçu pour le monde du barbier. Lorsqu'il est utilisé en mode "Barber" l'air et la température sont parfaitement étalonnés pour manipuler et respecter la barbe et la moustache. En utilisation normale, vous pouvez trouver la performance professionnelle habituelle des sèche-cheveux Ceriotti. La conception et la couleur «bronze» donnent à votre salon une touche personnelle et professionnelle.

Dem Föhen gewidmet und für die Barber Welt entworfen. Bei Verwendung im "Barber" -Modus sind Luft und Temperatur perfekt aufeinander abgestimmt um Bart und Schnurrbart schonend zu behandeln. Im normalen Gebrauch finden Sie die übliche professionelle Leistung von jedem Ceriotti-Fön. Das Design und die "Bronze" -Farbe geben Ihrem Salon eine persönliche und professionelle Note.

Secador de cabello dedicado y diseñado para el mundo del barbero. Cuando se usa en modo "Barber", el aire y la temperatura están perfectamente calibrados para manejar y respetar barba y bigote.

En el uso normal, usted puede encontrar el funcionamiento profesional típico de los secadores de Ceriotti. El diseño y el color "bronce" dan a su salón un toque personal y profesional.



E3236



7256



ELOGY Barber

Carrello con sei cassetti estraibili, vani contenitori e sportelli superiori apribili a creare un piano di lavoro funzionale. Supporti laterali removibili per alloggiare bombole, flaconi, phon e piastre.

Trolley with six removable drawers, open compartments and upper doors that can be open to create a functional worktop. Removable side supports to place bottles, tanks, dryers and irons.

Chariot avec six tiroirs amovibles, compartiments ouverts et portes supérieures qui peuvent être ouverts pour créer un plan de travail fonctionnel. Supports latéraux amovibles pour placer des bouteilles, des réservoirs, des sècheurs et des lisseurs.

Trolley mit sechs herausnehmbaren Schubladen, offenen Fächern und oberen Türen, die geöffnet werden können, um eine funktionale Arbeitsplatte zu schaffen. Abnehmbare Seitenstützen um Flaschen, Tanks, Föhne und Eisen abstellen zu können.

Carro con seis cajones extraíbles, compartimientos abiertos y puertas superiores que pueden abrirse para crear una encimera funcional. Soportes laterales extraíbles para colocar botellas, tanques, secadoras y planchas.





JUPITER



P48162SN RIF. 2M



P48164 RIF. 4M

Struttura, poggiatesta e braccioli in fusioni di alluminio lucidato e satinato. Schienale, seduta, braccioli ed inserti poggiatesta in poliuretano schiumato. Rivestimenti skai a scelta. Poggiatesta a scomparsa, regolabile ed estraibile. Meccanismo reclinabile sincrono per schienale ed alzagambe. Base con pompa idraulica e freno.

Structure, footrest and armrests in die-cast aluminum, polished and satin. Backrest, seat, armrests and footrest inserts in foamed polyurethane. Skai upholstery of your choice. Retractable headrest, adjustable and removable. Synchronous reclining mechanism for backrest and legrest. Base with hydraulic pump and brake.

Structure, repose-pieds et accoudoirs en aluminium moulé sous pression, poli et givré. Dossier, siège, accoudoirs et inserts de repose-pieds en mousse de polyuréthane. Revêtement skai à votre choix. Appuie-tête rétractable, réglable et amovible. Mécanisme d'inclinaison synchrone pour le dossier et le repose-jambes. Base avec pompe hydraulique et frein.

Struktur, Fußstütze und Armlehnen in Aluminium, poliert und satiniert. Rückenlehne, Sitz, Armlehnen und Fußrasteneinsätze aus geschäumtem Polyurethan. Breite skai Farbpalette verfügbar. Versenkbare Kopfstütze, verstellbar und abnehmbar. Synchroner Liegemechanismus für Rücken- und Beinlifting. Bodenteller mit hydraulisch arretierbarer Pumpe.

Estructura, reposapiés y reposabrazos en aluminio fundido a presión, pulido y satinado. Respaldo, asiento, reposabrazos e insertos de reposapiés en espuma de poliuretano. Tapicería skai de su elección. Reposacabezas retráctil, ajustable y extraíble. Mecanismo reclinable sincronizado para respaldo y reposapiernas. Base con bomba hidráulica y freno.

JUPITER 388



JUPITER



JUPITER 388



JUPITER



P48174PP RIF. 4M



JUPITER 388

CLUB HOUSE: Pezzi unici fatti a mano con dettagli che fanno la differenza. Dettagli raffinati, pregiate finiture e naturalmente bellezza estetica ne fanno esemplari unici

CLUB HOUSE: Unique handmade pieces with details that make the difference. Refined details and prestigious finishes they transform each chair in a unique piece.

CLUB HOUSE: Des pièces uniques faites à la main avec des détails qui font la différence. Détails raffinés et finitions prestigieuses, ils transforment chaque chaise en une pièce unique.

CLUB HOUSE: Einzigartige handgefertigte Stücke mit Details, die den Unterschied ausmachen. Raffinierte Details und repräsentative Oberflächen machen jeden Stuhl zu einem Unikat.

CLUB HOUSE: Piezas artesanales únicas con detalles que marcan la diferencia. Detalles refinados y acabados de prestigio transforman cada silla en una pieza única.



P48174PPSN RIF. 4M



JUPITER



P48184PPSN RIF. 4M



P48184PP RIF. 4M



JUPITER 388

TAILOR MADE: Cuciture elaborate e ricami personalizzabili, realizzati interamente a mano, per chi vive fuori dagli standard.

TAILOR MADE: Elaborate stitching and customizable embroidery, made entirely by hand, for those who live outside the standards.

TAILOR MADE: Coutures élaborées et broderies personnalisables, entièrement réalisées à la main, pour ceux qui ne respectent pas les normes.

TAILOR MADE: Aufwendige Nähte und anpassbare Stickereien, komplett von Hand gefertigt, für diejenigen, die außerhalb der Standards leben.

TAILOR MADE: Costuras elaboradas y bordados personalizables, hechos completamente a mano, para aquellos que viven fuera de los estándares.



Schienale in alluminio con sistema poggiatesta incorporato.

Aluminum backrest with incorporated headrest.



Marchio Ceriotti e Made in Italy impresso nello schienale. Ulteriore certificazione di origine italiana.

Ceriotti and Made in Italy marks embossed in the backrest. Additional proof of the Italian origin.

Sistema sdraio senza pompa a gas, regolabile e registrabile a piacimento.

Fully adjustable and tunable reclining system without gas pump.

Braccioli in alluminio robusti ed eleganti.
Solid and elegant aluminum armrests.



Telaio di sdraio poggiapiedi in alluminio. Forma ed eleganza unite alla massima robustezza.

Ceriotti and Made in Italy marks embossed in the backrest. Additional proof of the Italian origin.

Robusto telaio di alluminio con sistema di tracciatura di origine.
Sturdy aluminum chassis with embossed Made in Italy mark.

Basi con pompa idraulica con freno.



Pedana in pressofusione con poggiatesta a ribalta.
Die-cast footrest with tip-over legrest.

Esperienza, passione e ricerca da quarant'anni al servizio del parrucchiere.

40 Years of experience, passion and research at the service of the hairstylists



JUPITER 388

Semplicemente UNICA nel suo genere.....
Costruita secondo la tradizione con le
più avanzate tecniche di stampaggio.
L'UNICA poltrona barber interamente in
fusioni di alluminio.

Simply UNIQUE.
Built according to tradition, with the
latest molding techniques.
The ONLY barber chair entirely in die-
cast aluminum.

 **JUPITER**



P48194 RIF. 4M



P48194SN RIF. 4M



JUPITER 507

Struttura in metallo. Schienale e seduta in poliuretano schiumato con inserti in legno. Rivestimenti skai a scelta. Poggiatesta in alluminio pressofuso, lucidato e satinato. Base con pompa idraulica e freno. Schienale reclinabile e poggiatesta regolabile.

Metal structure. Backrest and seat in polyurethane foam on wooden structure. Skai upholstery of your choice. Footrest in die-cast aluminium, polished and satin. Base with hydraulic pump and brake. Reclining backrest with adjustable head support.

Structure en métal. Dossier et assise en mousse de polyuréthane avec des parties en bois. Revêtement en skai à choisir. Repose-pied en aluminium moulé sous pression, polie et givré. Base pivotante avec pompe hydraulique et frein. Dossier inclinable et repose-tête réglable.

Metallstruktur. Rückenlehne und Sitz in Polyurethanschaum auf Holzstruktur. Breite skai Farbpalette verfügbar. Fußstütze aus Aluminium-Druckguss, poliert und glasiert. Bodenteller mit hydraulisch arretierbarer Pumpe. Liegende Rückenlehne mit verstellbarer Kopfstütze.

Estructura de metal. Respaldo y asiento de poliuretano espumado con suplementos de madera. Revestimientos skai a elección. Soportes apoyapiés de aluminio fundido a presión, pulido y satinado. Base con bomba hidráulica con freno. Respaldo reclinable y apoyacabeza ajustable.





KENT

Struttura in metallo. Schienale e seduta in poliuretano schiumato con inserti in legno. Braccioli in alluminio pressofuso. Rivestimenti skai a scelta. Poggiapiedi in poliuretano su struttura in alluminio pressofuso, lucidato e satinato. Base con pompa idraulica e freno. Schienale reclinabile e poggiatesta regolabile.

Metal structure. Backrest and seat in polyurethane foam on wooden structure. Armrests in die-cast aluminium, polished and satin. Skai upholstery of your choice. Footrest in polyurethane on aluminium inserts, polished and glazed. Base with hydraulic pump and brake. Reclining backrest with adjustable head support.

Structure en métal. Dossier et assise en mousse de polyuréthane avec des parties en bois. Accoudoirs en aluminium moulé sous pression, polis et givré. Revêtement en skai à choisir. Repose-pied en polyuréthane avec des parties en aluminium moulé sous pression, polie et givré. Base pivotante avec pompe hydraulique et frein. Dossier inclinable et repose-tête réglable.

Metallstruktur. Rückenlehne und Sitz in Polyurethanschaum auf Holzstruktur. Armlehnen aus Aluminium-Druckguss, poliert und glasiert. Breite skai Farbpalette verfügbar. Fußstütze aus Polyurethanschaum auf Aluminiumstruktur, poliert und glasiert. Bodenteller mit hydraulisch arretierbarer Pumpe. Liegende Rückenlehne mit verstellbarer Kopfstütze.

Estructura de metal. Respaldo y asiento de poliuretano espumado con suplementos de madera. Apoyabrazos en aluminio fundido a presión, pulido y escarchado. Revestimientos skai a elección. Soportes apoyapiés de poliuretano con suplementos de aluminio fundido a presión, pulido y satinado. Base con bomba hidráulica con freno. Respaldo reclinable y apoya-cabeza ajustable.

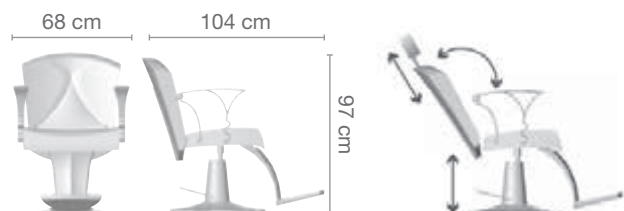

P48103 RIF. 3M



OLIVER

Struttura in metallo. Schienale e seduta in poliuretano schiumato con inserti in legno. Rivestimenti skai a scelta. Poggiatesta in poliuretano su struttura in alluminio pressofuso, lucidato e satinato. Base con pompa idraulica e freno. Schienale reclinabile e poggiatesta regolabile.

Metal structure. Backrest and seat in polyurethane foam on wooden structure. Skai upholstery of your choice. Footrest in polyurethane on aluminium inserts, polished and satin. Base with hydraulic pump and brake. Reclining backrest with adjustable head support.

Structure en métal. Dossier et assise en mousse de polyuréthane avec des parties en bois. Revêtement en skai à choisir. Repose-pied en polyuréthane avec des parties en aluminium moulé sous pression, polie et givré. Base pivotante avec pompe hydraulique et frein. Dossier inclinable et repose-tête réglable.

Metallstruktur. Rückenlehne und Sitz in Polyurethanschaum auf Holzstruktur. Breite skai Farbpalette verfügbar. Fußstütze aus Polyurethanschaum aus Aluminiumstruktur, poliert und glasiert. Bodenteller mit hydraulisch arretierbarer Pumpe. Liegende Rückenlehne mit verstellbarer Kopfstütze.

Estructura de metal. Respaldo y asiento de poliuretano espumado con suplementos de madera. Revestimientos skai a elección. Soportes apoyapiés de poliuretano con suplementos de aluminio fundido a presión, pulido y satinado. Base con bomba hidráulica con freno. Respaldo reclinable y apoyacabeza ajustable.



P48203 RIF. 3M





ROYAL

Struttura in metallo. Schienale e seduta in poliuretano schiumato con inserti in legno. Rivestimenti skai a scelta. Carter e braccioli in polipropilene. Supporti poggiapiedi e poggiatesta in poliuretano. Base con pompa idraulica e freno. Schienale reclinabile e poggiatesta regolabile.

Metal structure. Backrest and seat in polyurethane foam on wooden structure. Skai upholstery of your choice. Cover and armrests in polypropylene. Footrest and headrest in polyurethane. Base with hydraulic pump and brake. Reclining backrest with adjustable head support.

Structure en métal. Dossier et assise en mousse de polyuréthane avec des parties en bois. Revêtement en skai à choisir. Couverture et accoudoirs en polypropylène. Repose-pieds et repose-tête en polyuréthane. Base pivotante avec pompe hydraulique et frein. Dossier inclinable et repose-tête réglable.

Metallstruktur. Rückenlehne und Sitz in Polyurethanschaum auf Holzstruktur. Breite skai Farbpalette verfügbar. Deckel und Armlehnen aus Polypropylen. Fußstütze und Kopfstütze aus Polyurethan. Bodenteller mit hydraulisch arretierbarer Pumpe. Liegende Rückenlehne mit verstellbarer Kopfstütze.

Estructura de metal. Respaldo y asiento de poliuretano espumado con suplementos de madera. Revestimientos skai a elección. Cáster y apoyabrazos de polipropilene. Soportes apoyapiés y apoyacabeza de poliuretano. Base con bomba hidráulica con freno. Respaldo reclinable y apoyacabeza ajustable.



G48133 RIF. 3M

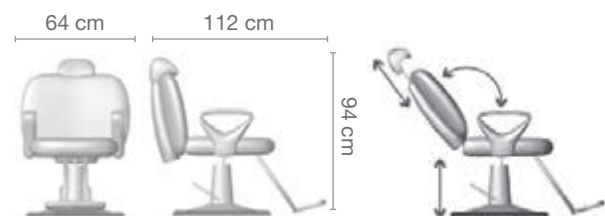



STYLE

Struttura in metallo. Schienale e seduta in poliuretano schiumato con inserti in legno. Rivestimenti skai a scelta. Carter e braccioli in polipropilene. Supporti poggiatesta e poggiatesta in poliuretano. Base con pompa idraulica e freno. Schienale reclinabile e poggiatesta regolabile.

Metal structure. Backrest and seat in polyurethane foam on wooden structure. Skai upholstery of your choice. Cover and armrests in polypropylene. Footrest and headrest in polyurethane. Base with hydraulic pump and brake. Reclining backrest with adjustable head support.

Structure en métal. Dossier et assise en mousse de polyuréthane avec des parties en bois. Revêtement en skai à choisir. Couverture et accoudoirs en polypropylène. Repose-pieds et repose-tête en polyuréthane. Base pivotante avec pompe hydraulique et frein. Dossier inclinable et repose-tête réglable.

Metallstruktur. Rückenlehne und Sitz in Polyurethanschaum auf Holzstruktur. Breite skai Farbpalette verfügbar. Deckel und Armlehnen aus Polypropylen. Fußstütze und Kopfstütze aus Polyurethan. Bodenteller mit hydraulisch arretierbarer Pumpe. Liegende Rückenlehne mit verstellbarer Kopfstütze.

Estructura de metal. Respaldo y asiento de poliuretano espumado con suplementos de madera. Revestimientos skai a elección. Cáster y apoyabrazos de polipropilene. Soportes apoyapiés y apoyacabeza de poliuretano. Base con bomba hidráulica con freno. Respaldo reclinable y apoyacabeza ajustable.



G48143 RIF. 3M

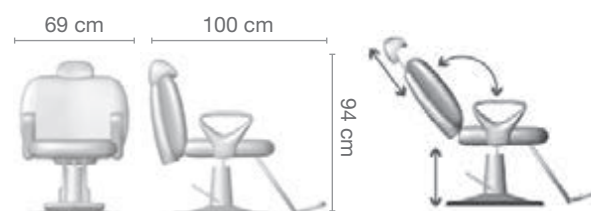





ROMA



LAVAGGI

WASHES

ALZAMI	pag 114
SOFT	pag 116
ALLUMINIUM CLOUD	pag 118
ALLUMINIUM NICOL	pag 119
SKID	pag 120
DOMO	pag 122
NOVI LOUNGE	pag 124
RELAX	pag 126
RELAX db	pag 127
OLLY	pag 128
HIRO	pag 129
FIBER CLOUD	pag 130
FIBER NICOL	pag 131
SPAZIO 7 SHIATSU	pag 132
EMOTION	pag 134
AMBIENTE BARCELLONA	pag 136
IMPERIAL	pag 138
IMPERIAL db	pag 139
OVER LARA CONFORT	pag 140
FIBER CLASS	pag 142
FIBER ASYA	pag 143
FIBER EMMA	pag 144
OXFORD	pag 145
FIBER GAIA	pag 146
SIMPLY	pag 147
FIBER SOFIA	pag 148
PRIVÈ	pag 150
BOTÈ	pag 152
COLONNE	pag 154
LAVATESTA	pag 155
MOBILE LAVAGGIO	pag 156



P57110CH



ALZAMI



Struttura, seduta e schienale in poliuretano schiumato con inserti in legno e metallo. Rivestimenti skai a scelta. Telaio in ferro zincato. Piano lavabo in metallo verniciato in elettroforesi. Lavabo in porcellana oscillante con snodo regolabile. Movimento alzagambe e alzata totale del lavaggio con pulsantiera integrata. Finitura a mano CLUB HOUSE disponibile a richiesta.

Structure, seat and backrest in polyurethane foam with wood and metal inserts. Skai upholstery of your choice. Galvanized iron frame. Electrocoated metal top. Swinging porcelain basin with adjustable junction. Legrest motion and lifting of the entire unit are controlled through integrated buttons. CLUB HOUSE handmade finish available upon request.

Structure, siège et dossier en mousse de polyuréthane avec des inserts en bois et en métal. Revêtement en skai à choisir. Cadre en fer galvanisé. Étagère métallique peinte par électrolyse. Cuvette en porcelaine oscillant avec joint réglable. Mouvement du repose-pied et levée de l'unité entière sont contrôlés par des boutons intégrés. Finition CLUB HOUSE faite à la main disponible sur demande.

Struktur, Sitz und Rückenlehne aus Polyurethanschaum auf Metall- und Holzstruktur. Elektrotacklackierung. Rahmen aus verzinktem Eisen. Breite skai Farbpalette verfügbar. Schwenkbares Keramikbecken mit verstellbaren Gelenken. Die Beinbewegung und das Heben der Struktur werden durch ein integriertes Drucktastenfeld gesteuert. Handarbeit CLUB HOUSE auf Anfrage.

Estructura, asiento y respaldo en espuma de poliuretano con inserciones de madera y metal. Revestimientos skai a elección. Marco de hierro galvanizado. Parte superior de metal electrovestido. Lavabo de porcelana oscilante. Movimiento levantapiernas y levantamiento de todo el lavacabeza con pulsador integrado. Acabado CLUB HOUSE hecho a mano disponible bajo demanda.

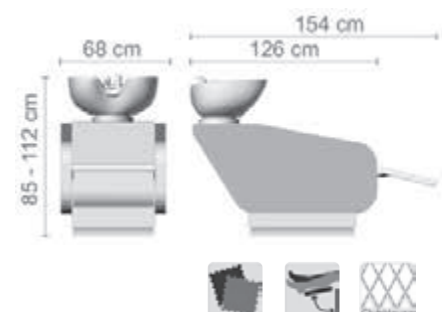



P57155NSN



P57155

SOFT



Struttura in vetroresina bianca o nera. Rivestimenti skai a scelta. Lavabo in porcellana oscillante con snodo regolabile. Vaschette porta tutto. Possibilità alzagambe elettrico.

Fiberglass structure, white or black. Skai upholstery of your choice. Swinging ceramic basin with adjustable junction. Multipurpose trays. Optional electrical legrest.

Structure en fibre de verre blanche ou noire. Revêtement en skai à choisir. Cuvette en porcelaine oscillante avec joint réglable avec joint réglable. Bacs multifonction. Reposepied électrique en option.

Weißer oder schwarzer Fiberglasstruktur. Breite skai Farbpalette verfügbar. Schwenkbares Keramikbecken mit verstellbaren Gelenken. Mehrzweckschalen. Optionale elektrische Beinheber.

Estructura de fibra de vidrio blanca o negra. Revestimientos skai a elección. Lavabo en porcelana oscilante con articulación ajustable. Bandejas multiuso. Posibilidad levantapiernas Eléctrico.



○ ●
Colori / Colours





ALLUMINIUM CLOUD

Scocca in poliuretano schiumato con doppio inserto in poliuretano rigido. Struttura in alluminio pressofuso. Lavabo in porcellana oscillante con snodo regolabile.

Polyuréthane foam body with double rigid polyuréthane insert. Skai upholstery of your choice. Structure in die-cast aluminium. Swinging ceramic basin with adjustable junction.

Coque en mousse de polyurethane avec double insert en polyurethane rigide. Revêtement skai à choisir. Structure en aluminium moulé sous pression. Cuvette en porcelaine oscillant avec joint réglable.

Struktur des Polyurethanschaums mit doppelter steifer Einfügung. Breite skai Farbpalette verfügbar. Struktur aus Aluminiumdruckguss. Schwenkbares Keramikbecken mit verstellbaren Gelenken.

Estructura de espuma de poliuretano con doble inserción rígida. Revestimientos skai a elección. Estructura en aluminio fundido a presión. Lavabo en porcelana oscilante con articulación ajustable.

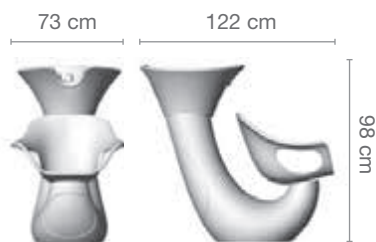

P57092





ALLUMINIUM NICOL

Monoscocca in poliuretano schiumato con inserti in polipropilene. Rivestimenti skai a scelta. Struttura in alluminio pressofuso. Lavabo in porcellana oscillante con snodo regolabile.

Polyurethane foam monocoque with polypropylene structure. Skai upholstery of your choice. Structure in die-cast aluminium. Swinging ceramic basin with adjustable junction.

Monocoque de polyuréthane avec structure en polypropylène. Revêtement en skai à choisir. Structure en aluminium moulé sous pression. Cuvette en porcelaine oscillante avec joint réglable.

Polyurethanschaum-Monocoque mit Polypropylenstruktur. Breite skai Farbpalette verfügbar. Struktur aus Aluminiumdruckguss. Schwenkbares Keramikbecken mit verstellbaren Gelenken.

Monocasco de espuma de poliuretano con estructura de polipropileno. Revestimientos skai a elección. Estructura en aluminio fundido a presión. Lavabo en porcelana oscilante con articulación ajustable.

P57145

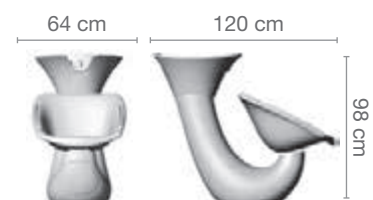



P57071V
VIBRO MASSAGGIO
CON ALZAGAMBE ELETTRICO



SKID



P57071

Braccioli, seduta e schienale in poliuretano schiumato con inserti in legno e metallo. Rivestimenti skai a scelta. Inserti braccioli e piedi in alluminio pressofuso. Colonna in ABS bianco o nero. Lavabo in porcellana oscillante con snodo regolabile. Possibilità alzagambe e/o massaggio vibrante.

Backrest, seat and armrests in polyurethane foam on a wooden and metal structure. Skai upholstery of your choice. Column in white or black ABS. Swinging porcelain basin with adjustable junction. Optional legrest and/or vibrating massage.

Dossier, assise et bras en mousse de polyuréthane avec des parties en bois et métal. Revêtement en skai à choisir. Colonne en ABS blanc ou noir. Cuvette en porcelaine oscillant avec joint réglable. Repose-pied et/ou massage vibrant en option.

Rückenlehne, Sitz und Armlehnen aus Polyurethanschaum auf Holz- und Metallstruktur. Breite skai Farbpalette verfügbar. Säule in weiß oder schwarz ABS. Schwenkbares Keramikbecken mit verstellbaren Gelenken. Optionaler elektrischer Beinlifter und/oder Vibrierende Massage.

Respaldo, asiento y apoyabrazos de poliuretano espumado con estructura del sillón de madera y metal. Revestimientos skai a elección. Columna en ABS blanco o negro. Lavabo en porcelana oscilante con articulación ajustable. Posibilidad levantapiernas eléctrico y/o vibro masaje.

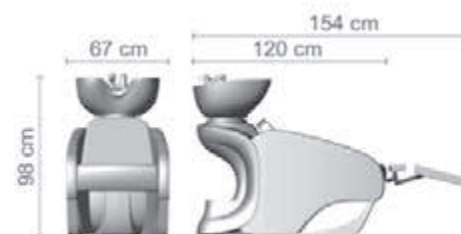

○ ●
 Colori / Colours





P57137NSN

DOMO

Braccioli, seduta e schienale in poliuretano schiumato con inserti in legno e metallo. Rivestimenti skai a scelta. Struttura in vetroresina bianco o nero. Lavabo in porcellana oscillante con snodo regolabile. Vaschette porta tutto. Possibilità alzagambe elettrico e/o massaggio vibrante.

Backrest, seat and armrests in polyurethane foam on a wooden and metal structure. Skai upholstery of your choice. Fiberglass structure, white or black. Swinging ceramic basin with adjustable junction. Multipurpose trays. Optional legrest and/or vibrating massage.

Dossier, assise et bras en mousse de polyuréthane avec des parties en bois et métal. Revêtement en skai à choisir. Structure en fibre de verre blanche ou noire. Cuvette en porcelaine oscillant avec joint réglable. Bacs multifonction. Repose-pied et/ou massage vibrant en option.

Rückenlehne, Sitz und Armlehnen aus Polyurethanschaum auf Holz- und Metallstruktur. Breite skai Farbpalette verfügbar. Weiße oder schwarze Fiberglasstruktur. Schwenkbares Keramikbecken mit verstellbaren Gelenken. Mehrzweckschalen. Optionaler elektrische Beinlifte und/oder Vibrierende Massage.

Respaldo, asiento y apoyabrazos de poliuretano espumado con estructura del sillón de madera y metal. Revestimientos skai a elección. Estructura de fibra de vidrio blanca o negra. Lavabo en porcelana oscilante con articulación ajustable. Bandejas multiuso. Posibilidad levantapiernas eléctrico y/o vibro masaje.



P57137A
CON ALZAGAMBE ELETTRICO

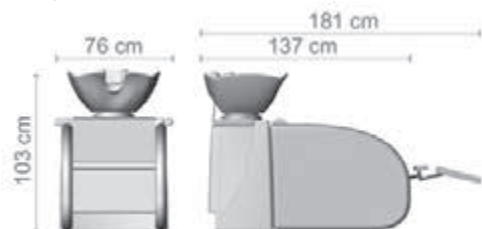



DOMO Shiatsu

Braccioli, seduta e schienale in poliuretano schiumato con inserti in legno e metallo. Rivestimenti skai a scelta. Struttura in vetroresina bianco o nero. Lavabo in porcellana oscillante con snodo regolabile. Vaschette porta tutto. Completo di alzagambe elettrico e schienale con massaggio shiatsu o stretch.

Backrest, seat and armrests in polyurethane foam on a wooden and metal structure.

Skai upholstery of your choice. Fiberglass structure, white or black. Swinging ceramic basin with adjustable junction. Multipurpose trays. Moving footrest and backrest with shiatsu or stretch massage.

Dossier, assise et bras en mousse de polyuréthane avec des parties en bois et métal. Revêtement en skai à choisir.

Structure en fibre de verre blanche ou noire. Cuvette en porcelaine oscillant avec joint réglable avec joint réglable. Bacs multifonction. Repose-pied movable et dossier avec massage shiatsu ou stretch.

Rückenlehne, Sitz und Armlehnen aus Polyurethanschaum auf Holz- und Metallstruktur. Breite skai Farbpalette verfügbar. Weiße oder schwarze Fiberglasstruktur. Schwenkbares Keramikbecken mit verstellbaren Gelenken. Mehrzweckschalen.

Bewegliche Fußstütze und Rückenlehne mit Shiatsu- oder Stretch-Massage.

Respaldo, asiento y apoyabrazos de poliuretano espumado con estructura del sillón de madera y metal. Revestimientos skai a elección. Estructura de fibra de vidrio blanca o negra. Lavabo en porcelana oscilante con articulación ajustable. Bandejas multiuso. Levantapiernas y respaldo con masaje shiatsu o stretch.



○ ●
 Colori / Colours



P57137NSNH
 MASSAGGIO SHIATSU



P57141NSNA
CON ALZAGAMBE ELETTRICO

NOVI LOUNGE



P57141

Schienale, seduta e braccioli in poliuretano schiumato con inserti in legno multistrato. Rivestimenti skai a scelta. Struttura in vetroresina bianca o nera. Lavabo in porcellana oscillante con snodo regolabile. Vaschette porta tutto. Possibilità alzata gambe elettrico.

Backrest, seat and armrests in polyurethane foam on wooden structure. Skai upholstery of your choice. Fiberglass structure, white or black. Swinging ceramic basin with adjustable junction. Multipurpose trays. Optional electrical legrest.

Dossier et assise en mousse de polyuréthane avec des inserts en bois multicouche. Revêtement en skai à choisir. Structure en fibre de verre blanche ou noire. Cuvette en porcelaine oscillant avec joint réglable. Bacs multifonction. Repose-pied électrique en option.

Rückenlehne, Sitz und Armlehnen aus Polyurethanschaum auf Holzstruktur. Breite skai Farbpalette verfügbar. Weiße oder schwarze Fiberglasstruktur. Schwenkbares Keramikbecken mit verstellbaren Gelenken. Mehrzweckschalen. Optionale elektrische Beinheber.

Sillon con respaldao, asiento y apoyabrazos en poliuretano espumado y estructura de madera multistrato. Revestimientos skai a elección. Estructura de fibra de vidrio blanca o negra. Lavabo en porcelana oscilante con articulación ajustable. Bandejas multiuso. Posibilidad levantapiernas eléctrico.

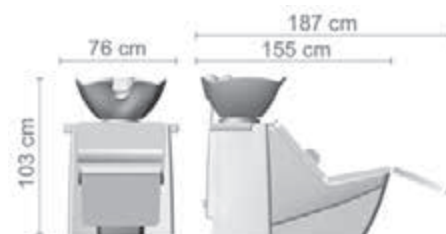

○ ●
Colori / Colours





G57134A
CON ALZAGAMBE ELETTRICO

RELAX

Struttura, seduta e schienale in poliuretano schiumato con inserti in legno e metallo. Rivestimenti skai a scelta. Piani multifunzione in metallo verniciato in elettroforesi. Lavabo in porcellana oscillante con snodo regolabile. Possibilità alzagambe elettrico e/o massaggio vibrante.

Structure, seat and backrest in polyurethane foam on a metal and wooden structure. Skai upholstery of your choice. Electrocoated metal shelves. Swinging porcelain basin with adjustable junction. Optional legrest and/or vibrating massage.

Structure, assise et dossier en mousse de polyuréthane avec des parties en bois et métal. Revêtement en skai à choisir. Étagères métalliques peintes par électrophorèse. Cuvette en porcelaine oscillant avec joint réglable. Repose-pied et/ou massage vibrant en option.

Struktur, Sitz und Rückenlehne aus Polyurethanschäum auf Metall- und Holzstruktur. Breite skai Farbpalette verfügbar. Pulverbeschichtete Metallregale. Schwenkbares Keramikbecken mit verstellbaren Gelenken. Optionaler elektrische Beinlufe und/oder Vibrierende Massage.

Respaldo, asiento y apoyabrazos en poliuretano espumado con estructura de madera y metal. Revestimientos skai a elección. Estantes multifunciones en metal barnizado en electroforesis. Lavabo en porcelana oscilante con articulación ajustable. Posibilidad levantapiernas eléctrico y/o vibro masaje.



G57134

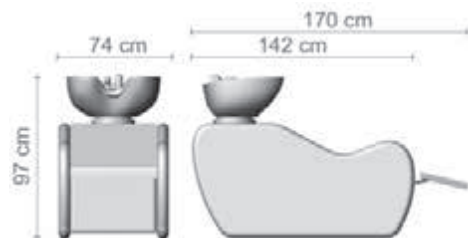



G57131NA
 CON ALZAGAMBE ELETTRICO

RELAX db

Struttura, seduta e schienale in poliuretano schiumato con inserti in legno e metallo. Rivestimenti skai a scelta. Piani multifunzione in metallo verniciato in elettroforesi. Lavabo in porcellana oscillante con snodo regolabile. Possibilità alzagambe elettrico e/o massaggio vibrante.

Structure, seat and backrest in polyurethane foam on a metal and wooden structure. Skai upholstery of your choice. Electrocoated metal shelves. Swinging porcelain basin with adjustable junction. Optional legrest and/or vibrating massage.

Structure, assise et dossier en mousse de polyuréthane avec des parties en bois et métal. Revêtement en skai à choisir. Étagères métalliques peintes par électrophorèse. Cuvette en porcelaine oscillant avec joint réglable. Repose-pied et/ou massage vibrant en option.

Struktur, Sitz und Rückenlehne aus Polyurethanschaum auf Metall-und Holzstruktur. Breite skai Farbpalette verfügbar. Pulverbeschichtete Metallregale. Schwenkbares Keramikbecken mit verstellbaren Gelenken. Optionaler elektrischer Beinlifter und/oder Vibrierende Massage.

Respaldo, asiento y apoyabrazos en poliuretano espumado con estructura de madera y metal. Revestimientos skai a elección. Estantes multifunciones en metal barnizado en electroforesis.

Lavabo in porcellana oscillante con articolazione regolabile. Possibilità alzapierna elettrico y/o vibro masaje.

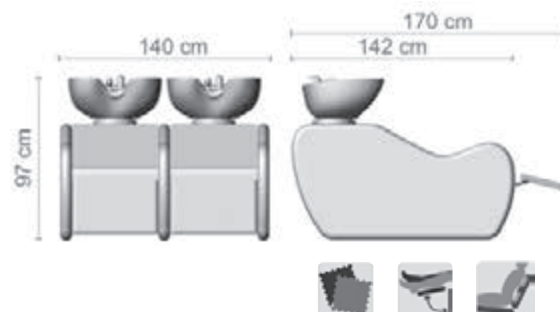



G57127NSN

OLLY

Schienale e seduta in poliuretano schiumato con inserti in metallo e legno multistrato. Rivestimenti skai a scelta. Struttura in vetroresina bianco o nero. Lavabo in porcellana oscillante con snodo regolabile. Vaschette porta tutto.

Backrest and seat in polyurethane foam on metal and multilayer wooden structure. Skai upholstery of your choice. Fiberglass structure, white or black. Swinging ceramic basin with adjustable junction. Multipurpose trays.

Dossier et assise en mousse de polyuréthane avec des parties en bois multicouche et métal. Revêtement en skai à choisir. Structure en fibre de verre blanche ou noire. Cuvette en porcelaine oscillant avec joint réglable. Bacs multifonction.

Rückenlehne und Sitz aus Polyurethan Schaum auf Metall und Holzstruktur. Breite skai Farbpalette verfügbar. Weiße oder schwarze Fiberglasstruktur. Schwenkbares Keramikbecken mit verstellbaren Gelenken. Mehrzweckschalen.

Respaldo y asiento de poliuretano espumado con estructura de metal y multicapa de madera. Revestimientos skai a elección. Estructura de fibra de vidrio blanca o negra. Lavabo en porcelana oscilante con articulación ajustable. Bandejas multiuso.

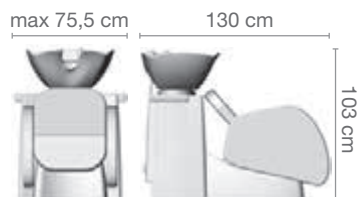

G57127



G57157



HIRO

Braccioli, seduta e schienale in poliuretano schiumato con inserti in legno e metallo. Rivestimenti skai a scelta. Struttura in vetroresina bianco o nero. Lavabo in porcellana oscillante con snodo regolabile. Vaschette porta tutto. Possibilità alzata gambe elettrico.

Backrest, seat and armrests in polyurethane foam on a wooden and metal structure. Skai upholstery of your choice. Fiberglass structure, white or black. Swinging ceramic basin with adjustable junction. Multipurpose trays. Optional electrical legrest.

Dossier, assise et bras en mousse de polyuréthane avec des inserts en bois et métal. Revêtement en skai à choisir. Structure en fibre de verre blanche ou noire. Cuvette en porcelaine oscillant avec joint réglable. Bacs multifonction. Reposepied électrique en option.

Rückenlehne, Sitz und Armlehnen aus Polyurethanschaum auf Holz- und Metallstruktur. Breite skai Farbpalette verfügbar. Weiße oder schwarze Fiberglasstruktur. Schwenkbares Keramikbecken mit verstellbaren Gelenken. Mehrzweckschalen. Optionale elektrische Beinheber.

Respaldo, asiento y apoyabrazos de poliuretano espumado con estructura del sillón de madera y metal. Revestimientos skai a elección. Estructura de fibra de vidrio blanca o negra. Lavabo en porcelana oscilante con articulación ajustable. Bandejas multiuso. Posibilidad levantapiernas Eléctrico.

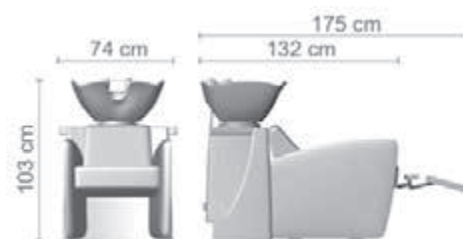



FIBER CLOUD

Scocca in poliuretano schiumato con doppio inserto in poliuretano rigido. Struttura in vetroresina bianco o nero. Lavabo in porcellana oscillante con snodo regolabile.

Polyuréthane foam body with double rigid polyuréthane insert. Skai upholstery of your choice. Fiberglass structure, white or black. Swinging ceramic basin with adjustable junction.

Coque en mousse de polyurethane avec double insert en plyurethane rigide. Revêtement skai à choisir. Structure en fibre de verre blanche ou noire. Cuvette en porcelaine oscillant avec joint réglable.

Struktur des Polyurethanschaums mit doppelter steifer Einfügung. Breite skai Farbpalette verfügbar. Weiße oder schwarze Fiberglasstruktur. Schwenkbares Keramikbecken mit verstellbaren Gelenken.

Estructura de espuma de poliuretano con doble inserción rígida. Revestimientos skai a elección. Estructura de fibra de vidrio blanca o negra. Lavabo en porcelana oscilante con articulación ajustable.

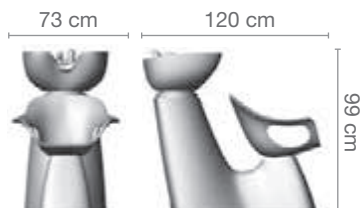

○ ●
Colori / Colours



P57106



P57146



P57146NSN

FIBER NICOL

Monoscocca in poliuretano schiumato con inserti in polipropilene. Rivestimenti skai a scelta. Struttura in vetroresina bianco o nero. Lavabo in porcellana oscillante con snodo regolabile.

Polyurethane foam monocoque with polypropylene structure. Skai upholstery of your choice. Fiberglass structure, white or black. Swinging ceramic basin with adjustable junction.

Monocoque de polyuréthane avec structure en polypropylène. Revêtement en skai à choisir. Structure en fibre de verre blanche ou noire. Cuvette en porcelaine oscillant avec joint réglable.

Polyurethanschaum-Monocoque mit Polypropylenstruktur. Breite skai Farbpalette verfügbar. Weiße oder schwarze Fiberglasstruktur. Schwenkbares Keramikbecken mit verstellbaren Gelenken.

Monocasco de espuma de poliuretano con estructura de polipropileno. Revestimientos skai a elección. Estructura de fibra de vidrio blanca o negra. Lavabo en porcelana oscilante con articulación ajustable.

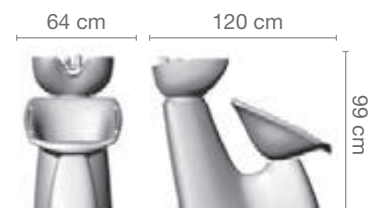



P57029

SPAZIO 7 SHIATSU



Braccioli, seduta e schienale in poliuretano schiumato con inserti in legno e metallo. Rivestimenti skai a scelta. Telaio in ferro verniciato in elettroforesi. Lavabo in porcellana oscillante con snodo regolabile. Vaschette porta tutto. Completo di alzagambe elettrico e schienale con massaggio shiatsu o stretch.

Backrest, seat and armrests in polyurethane foam on a wooden and metal structure. Skai upholstery of your choice. Electrocoated iron frame. Swinging ceramic basin with adjustable junction. Multipurpose trays. Moving footrest and backrest with shiatsu or stretch massage.

Dossier, assise et bras en mousse de polyuréthane avec des parties en bois et métal. Revêtement en skai à choisir. Cadre en fer peint en électrophorèse. Cuvette en porcelaine oscillante avec joint réglable avec joint réglable. Bacs multifonction. Repose-pied movable et dossier avec massage shiatsu ou stretch.

Rückenlehne, Sitz und Armlehnen aus Polyurethanschaum auf Holz- und Metallstruktur. Breite skai Farbpalette verfügbar. Eisenrahmen in Elektrophorese lackiert. Schwenkbares Keramikbecken mit verstellbaren Gelenken. Mehrzweckschalen. Bewegliche Fußstütze und Rückenlehne mit Shiatsu- oder Stretch-Massage.

Respaldo, asiento y apoyabrazos de poliuretano espumado con estructura del sillón de madera y metal. Revestimientos skai a elección. Marco de hierro pintado en electroforesis. Lavabo en porcelana oscilante con articulación ajustable. Bandejas multiuso. Levantapiernas y respaldo con masaje shiatsu o stretch.

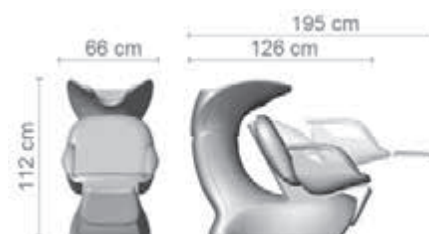



P57158CHA
CON ALZAGAMBE ELETTRICO



P57158NCHA
 CON ALZAGAMBE ELETTRICO

Schienale, seduta e braccioli del lavaggio in poliuretano schiumato con inserto interno in legno e metallo. Rivestimenti skai a scelta. Piano in vetro. Lavabo in porcellana oscillante con snodo regolabile. Possibilità alzagambe e/o massaggio vibrante. **CLUB HOUSE:** Pezzi unici fatti a mano con dettagli che fanno la differenza. Dettagli raffinati, pregiate finiture e naturalmente bellezza estetica ne fanno esemplari unici.

Backrest, seat and armrests in polyurethane foam on a metal and wooden structure. Skai upholstery of your choice. Glass top. Swinging porcelain basin with adjustable junction. Optional electrical footrest and/or vibrating massage. **CLUB HOUSE:** Unique handmade pieces with details that make the difference. Refined details and prestigious finishes they transform each chair in a unique piece.

Dossier, assise et bras en mousse de polyuréthane avec des parties en bois et métal. Revêtement en skai à choisir. Top en verre. Cuvette en porcelaine oscillant avec joint réglable. Repose-pied électrique et/ou massage vibrant en option. **CLUB HOUSE:** Des pièces uniques faites à la main avec des détails qui font la différence. Détails raffinés et finitions prestigieuses, ils transforment chaque chaise en une pièce unique.

Struktur, Sitz und Rückenlehne aus Polyurethanschaum auf Metall- und Holzstruktur. Breite skai Farbpalette verfügbar. Glasregal. Schwenkbares Keramikbecken mit verstellbaren Gelenken. Optionaler elektrische Beinlifte und/oder Vibrierende Massage. **CLUB HOUSE:** Einzigartige handgefertigte Stücke mit Details, die den Unterschied ausmachen. Raffinierte Details und repräsentative Oberflächen machen jeden Stuhl zu einem Unikat.

Respaldo, asiento y apoyabrazos de poliuretano espumado con estructura de madera y metal. Revestimientos skai a elección. Estante de vidrio. Lavabo de porcelana oscilante con articulación ajustable. Posibilidad levantapiernas y/o vibro masaje. **CLUB HOUSE:** Piezas artesanales únicas con detalles que marcan la diferencia. Detalles refinados y acabados de prestigio transforman cada silla en una pieza única.

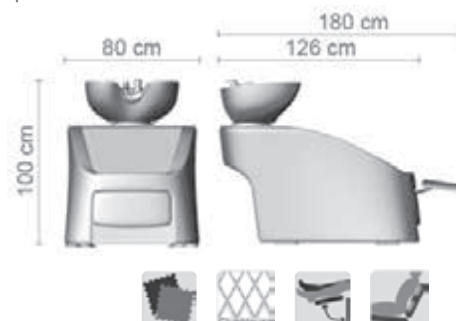

EMOTION







G57103

IMPERIAL

Struttura, seduta e schienale in poliuretano schiumato con inserti in legno e metallo. Rivestimenti skai a scelta. Piani multifunzione in metallo verniciato in elettroforesi. Lavabo in porcellana oscillante con snodo regolabile. Possibilità alzagambe elettrico e/o massaggio vibrante.

Structure, seat and backrest in polyurethane foam on a metal and wooden structure. Skai upholstery of your choice. Electrocoated metal shelves. Swinging porcelain basin with adjustable junction. Optional legrest and/or vibrating massage.

Structure, assise et dossier en mousse de polyuréthane avec des parties en bois et métal. Revêtement en skai à choisir. Étagères métalliques peintes par électrophorèse. Cuvette en porcelaine oscillant avec joint réglable. Repose-pied et/ou massage vibrant en option.

Struktur, Sitz und Rückenlehne aus Polyurethanschaum auf Metall- und Holzstruktur. Breite skai Farbpalette verfügbar. Pulverbeschichtete Metallregale. Schwenkbares Keramikbecken mit verstellbaren Gelenken. Optionaler elektrische Beinlufe und/oder Vibrierende Massage.

Respaldo, asiento y apoyabrazos en poliuretano espumado con estructura de madera y metal. Revestimientos skai a elección. Estantes multifunciones en metal barnizado en electroforesis. Lavabo en porcelana oscilante con articulación ajustable. Posibilidad levantapiernas eléctrico y/o vibro masaje.



G57103A
CON ALZAGAMBE ELETTRICO

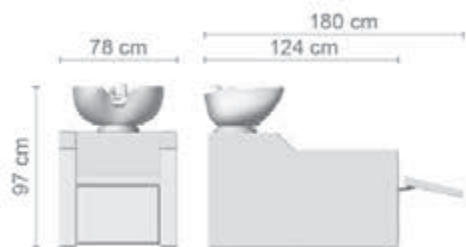



G57111

IMPERIAL db

Struttura, seduta e schienale in poliuretano schiumato con inserti in legno e metallo. Rivestimenti skai a scelta. Piani multifunzione in metallo verniciato in elettroforesi. Lavabo in porcellana oscillante con snodo regolabile. Possibilità alzagambe elettrico e/o massaggio vibrante.

Structure, seat and backrest in polyurethane foam on a metal and wooden structure. Skai upholstery of your choice. Electrocoated metal shelves. Swinging porcelain basin with adjustable junction. Optional legrest and/or vibrating massage.

Structure, assise et dossier en mousse de polyuréthane avec des parties en bois et métal. Revêtement en skai à choisir. Étagères métalliques peintes par électrophorèse. Cuvette en porcelaine oscillant avec joint réglable. Repose-pied et/ou massage vibrant en option.

Struktur, Sitz und Rückenlehne aus Polyurethanschaum auf Metall- und Holzstruktur. Breite skai Farbpalette verfügbar. Pulverbeschichtete Metallregale. Schwenkbare Keramikbecken mit verstellbaren Gelenken. Optionaler elektrische Beinliffe und/oder Vibrierende Massage.

Respaldo, asiento y apoyabrazos en poliuretano espumado con estructura de madera y metal. Revestimientos skai a elección. Estantes multifunciones en metal barnizado en electroforesis. Lavabo en porcelana oscilante con articulación ajustable. Posibilidad levantapiernas eléctrico y/o vibro masaje.

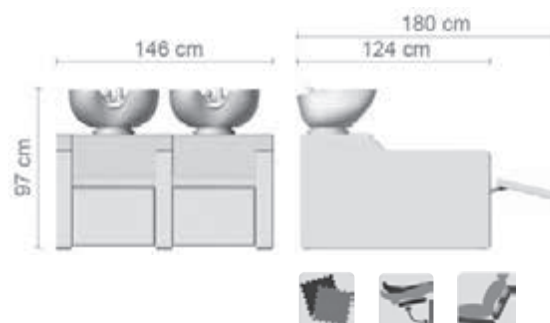



G57152NN

OVER LARA CONFORT



G57152NT

Monoscocca in polipropilene o policarbonato stampata ad iniezione. Cuscino in poliuretano schiumato con inserto in legno multistrato. Rivestimenti skai a scelta. Colonna in ABS e nylon bianco o nero. Lavabo in porcellana oscillante con snodo regolabile.

Polycarbonate or polypropylene monocoque, made by injection molding. Foamed polyurethane cushion with multilayer wood insert. Skai upholstery of your choice. Column in white or black ABS and nylon. Swinging porcelain basin with adjustable junction.

Monocoque en polycarbonate ou en polypropylène moulée par injection. Coussin en mousse de polyuréthane avec insert en bois multicouche. Revêtement en skai à choisir. Colonne en ABS et nylon blanc ou noir. Cuvette en porcelaine oscillant avec joint réglable.

Polycarbonat oder Polypropylen-Monocoque, im Spritzgussverfahren hergestellt. Geschäumtes Polyurethankissen mit mehrlagigem Holzeinsatz. Breite skai Farbpalette verfügbar. Säule in weiß oder schwarz ABS und Nylon. Schwenkbares Keramikbecken mit verstellbaren Gelenken.

Monocasco de polipropileno o policarbonato hecho a inyección. Cojín de espuma de poliuretano con inserción de madera multicapa. Revestimientos skai a elección. Columna en ABS y nylon blanco o negro. Lavabo en porcelana oscilante con articulación ajustable.

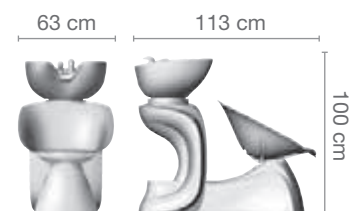

○ ●
Colori / Colours





G57120NSN

FIBER CLASS

Schienale, seduta e braccioli in poliuretano schiumato con inserti in legno multistrato. Supporti in alluminio pressofuso, lucidato e satinato. Rivestimenti skai a scelta. Telaio in vetroresina bianco o nero. Lavabo in porcellana oscillante con snodo regolabile.

Backrest, seat and armrests in polyurethane foam on wooden structure. Supports of die-cast aluminum, polished and satin. Skai upholstery of your choice. Fiberglass structure in white or black. Swinging porcelain washbasin.

Dossier et assise en mousse de polyuréthane avec des inserts en bois multicouche. Supports en aluminium moulé sous pression, poli et givré. Revêtement en skai à choisir. Châssis en fibre de verre blanc ou noir. Cuvette en porcelaine oscillant avec joint réglable.

Rückenlehne, Sitz und Armlehnen aus Polyurethanschaum auf Holzstruktur. Stützen aus Aluminium-Druckguss, poliert und satiniert. Breite skai Farbpalette verfügbar. Weiße oder schwarze Fiberglasstruktur. Schwenkbares Keramikbecken mit verstellbaren Gelenken.

Sillon con respaldao, asiento y apoyabrazos en poliuretano espumado y estructura de madera multistrato. Soportes de aluminio fundido a presión, pulido y satinado. Revestimientos skai a elección. Estructura de fibra de vidrio blanco o negro. Lavabo en porcelana oscilante con articulación ajustable.



G57120

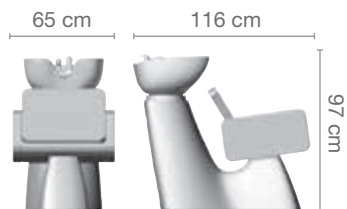

○ ●
Colori / Colours



G57097NSN



G57097

FIBER ASYA

Monoscocca in poliuretano schiumato con inserti in metallo. Rivestimenti skai a scelta. Telaio in vetroresina bianco o nero. Lavabo in porcellana oscillante con snodo regolabile.

Polyurethane foam monocoque with metal structure. Skai upholstery of your choice. Fiberglass structure in white or black. Swinging porcelain washbasin.

Monocoque de polyuréthane avec des parties en métal. Revêtement en skai à choisir. Châssis en fibre de verre blanc ou noir. Cuvette en porcelaine oscillant avec joint réglable.

Polyurethanschaum-Monocoque mit Metallstruktur. Breite skai Farbpalette verfügbar. Weiße oder schwarze Fiberglasstruktur. Schwenkbares Keramikbecken mit verstellbaren Gelenken.

Monocasco de espuma de poliuretano con estructura metálica. Revestimientos skai a elección. Estructura de fibra de vidrio blanco o negro. Lavabo en porcelana oscilante con articulación ajustable.

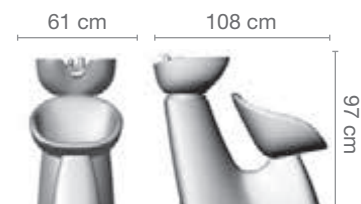

 Colori / Colours



FIBER EMMA

Schienale, seduta e braccioli in poliuretano schiumato con inserti in legno multistrato. Rivestimenti skai a scelta. Telaio in vetroresina bianco o nero. Lavabo in porcellana oscillante con snodo regolabile.

Backrest, seat and armrests in polyurethane foam on wooden structure. Skai upholstery of your choice. Fiberglass structure in white or black. Swinging porcelain washbasin.

Dossier et assise en mousse de polyuréthane avec des inserts en bois multicouche. Revêtement en skai à choisir. Châssis en fibre de verre blanc ou noir. Cuvette en porcelaine oscillant avec joint réglable.

Rückenlehne, Sitz und Armlehnen aus Polyurethanschaum auf Holzstruktur. Breite skai Farbpalette verfügbar. Weiße oder schwarze Fiberglasstruktur. Schwenkbares Keramikbecken mit verstellbaren Gelenken.

Sillon con respaldao, asiento y apoyabrazos en poliuretano espumado y estructura de madera multistrato. Revestimientos skai a elección. Estructura de fibra de vidrio blanco o negro. Lavabo en porcelana oscilante con articulación ajustable.

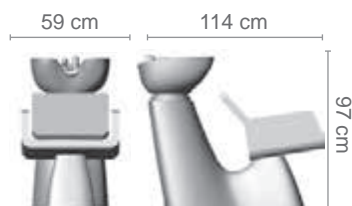

○ ●
Colori / Colours



P57159



P57159NSN



G57090N

OXFORD

Struttura, seduta e schienale in poliuretano schiumato con inserti in legno e metallo. Rivestimenti skai a scelta. Piani multifunzione in metallo verniciato in elettroforesi. Lavabo in porcellana oscillante con snodo regolabile.

Structure, seat and backrest in polyurethane foam on a metal and wooden structure. Skai upholstery of your choice. Electrocoated metal shelves. Swinging porcelain basin with adjustable junction.

Structure, assise et dossier en mousse de polyuréthane avec des parties en bois et métal. Revêtement en skai à choisir. Étagères métalliques peintes par électrophorèse. Cuvette en porcelaine oscillant avec joint réglable.

Struktur, Sitz und Rückenlehne aus Polyurethanschaum auf Metall- und Holzstruktur. Breite skai Farbpalette verfügbar. Pulverbeschichtete Metallregale. Schwenkbares Keramikbecken mit verstellbaren Gelenken.

Respaldo, asiento y apoyabrazos en poliuretano espumado con estructura de madera y metal. Revestimientos skai a elección. Estantes multifunciones en metal barnizado en electroforesis. Lavabo en porcelana oscilante con articulación ajustable.



G57090

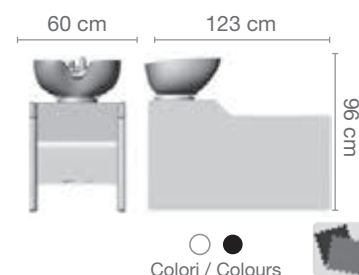



FIBER GAIA

Schienale, seduta e braccioli in poliuretano schiumato con inserti in legno multistrato. Rivestimenti skai a scelta. Telaio in vetroresina bianco o nero. Lavabo in porcellana oscillante con snodo regolabile.

Backrest, seat and armrests in polyurethane foam on a metal and wooden structure. Skai upholstery of your choice. Fiberglass structure in white or black. Swinging porcelain basin with adjustable junction.

Dossier et assise en mousse de polyuréthane avec des inserts en bois multicouche. Revêtement en skai à choisir. Châssis en fibre de verre blanc ou noir. Cuvette en porcelaine oscillant avec joint réglable.

Rückenlehne, Sitz und Armlehnen aus Polyurethanschaum auf Holzstruktur. Breite skai Farbpalette verfügbar. Weiße oder schwarze Fiberglasstruktur. Schwenkbares Keramikbecken mit verstellbaren Gelenken.

Sillon con respaldao, asiento y apoyabrazos en poliuretano espumado y estructura de madera multistrato. Revestimientos skai a elección. Estructura de fibra de vidrio blanco o negro. Lavabo en porcelana oscilante con articulación ajustable.



○ ●
Colori / Colours



G57160



G57160NSN



G57130NSN



G57130

SIMPLY

Schienale e seduta in poliuretano schiumato con inserti in metallo e legno multistrato. Rivestimenti skai a scelta. Struttura in vetroresina bianco o nero. Lavabo in porcellana oscillante con snodo regolabile. Vaschette porta tutto.

Backrest and seat in polyurethane foam on metal and multilayer wooden structure. Skai upholstery of your choice. Fiberglass structure, white or black. Swinging ceramic basin with adjustable junction. Multipurpose trays.

Dossier et assise en mousse de polyuréthane avec des parties en bois multicouche et métal. Revêtement en skai à choisir. Structure en fibre de verre blanche ou noire. Cuvette en porcelaine oscillant avec joint réglable. Bacs multifonction.

Rückenlehne und Sitz aus Polyurethan Schaum auf Metall und Holzstruktur. Breite skai Farbpalette verfügbar. Weiße oder schwarze Fiberglasstruktur. Schwenkbares Keramikbecken mit verstellbaren Gelenken. Mehrzweckschalen.

Respaldo y asiento de poliuretano espumado con estructura de metal y multicapa de madera. Revestimientos skai a elección. Estructura de fibra de vidrio blanca o negra. Lavabo en porcelana oscilante con articulación ajustable. Bandejas multiuso.



○ ●
Colori / Colours



G57161



G57161NSN

FIBER SOFIA



Schienale, seduta e braccioli in poliuretano schiumato con inserti in legno multistrato. Rivestimenti skai a scelta. Telaio in vetroresina bianco o nero. Lavabo in porcellana oscillante con snodo regolabile.

Backrest, seat and armrests in polyurethane foam on a metal and wooden structure. Skai upholstery of your choice. Fiberglass structure in white or black. Swinging porcelain basin with adjustable junction.

Dossier et assise en mousse de polyuréthane avec des inserts en bois multicouche. Revêtement en skai à choisir. Châssis en fibre de verre blanc ou noir. Cuvette en porcelaine oscillant avec joint réglable.

Rückenlehne, Sitz und Armlehnen aus Polyurethanschaum auf Holzstruktur. Breite skai Farbpalette verfügbar. Weiße oder schwarze Fiberglasstruktur. Schwenkbares Keramikbecken mit verstellbaren Gelenken.

Sillon con respaldao, asiento y apoyabrazos en poliuretano espumado y estructura de madera multistrato. Revestimientos skai a elección. Estructura de fibra de vidrio blanco o negro. Lavabo en porcelana oscilante con articulación ajustable.

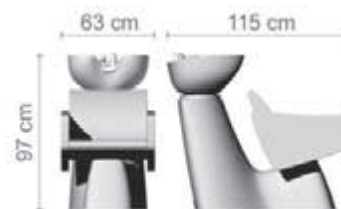

○ ●
 Colori / Colours 



G57162NA
CON ALZAGAMBE ELETTRICO

PRIVÈ



G57162



Struttura, seduta e schienale in poliuretano schiumato con inserti in legno e metallo. Rivestimenti skai a scelta. Piani multifunzione in metallo verniciato in elettroforesi. Lavabo in porcellana oscillante con snodo regolabile. Possibilità alzagambe elettrico.

Structure, seat and backrest in polyurethane foam on metal and wooden structure. Skai upholstery of your choice. Electro-coated metal shelves. Swinging porcelain basin with adj stable junction. Optional legrest.

Structure, assise et dossier en mousse de polyuréthane avec des parties en bois et métal. Revêtement en skai à choisir. Étagères métalliques peints par électrophorèse. Cuvette en porcelaine oscillant avec joint réglable. Repose-pied en option.

Struktur, Sitz und Rückenlehne aus Polyurethanschaum auf Metall- und Holzstruktur. Breite skai Farbpalette verfügbar. Pulverbeschichtete Metallregale. Schwenkbares Keramikbecken mit verstellbaren Gelenken. Optionaler elektrische Beinlufe.

Respaldo, asiento y apoyabrazos en poliuretano espumado con estructura de madera y metal. Revestimientos skai a elección. Estantes multifunciones en metal barnizado en electroforesis. Lavabo en porcelana oscilante con articulación ajustable. Posibilidad levantapiernas eléctrico.

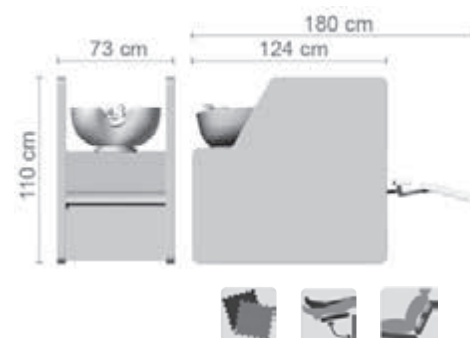



P57163A
CON ALZAGAMBE ELETTRICO



P57163N

BOTÈ



Struttura, seduta e schienale in poliuretano schiumato con inserti in legno e metallo. Rivestimenti skai a scelta. Piani multifunzione in metallo verniciato in elettroforesi. Lavabo in porcellana oscillante con snodo regolabile. Possibilità alzagambe elettrico e/o massaggio vibrante.

Structure, seat and backrest in polyurethane foam on a metal and wooden structure. Skai upholstery of your choice. Electrocoated metal shelves. Swinging porcelain basin with adjustable junction. Optional legrest and/or vibrating massage.

Structure, assise et dossier en mousse de polyuréthane avec des parties en bois et métal. Revêtement en skai à choisir. Étagères métalliques peints par électrophorèse. Cuvette en porcelaine oscillant avec joint réglable. Repose-pied et/ou massage vibrant en option.

Struktur, Sitz und Rückenlehne aus Polyurethanschaum auf Metall- und Holzstruktur. Breite skai Farbpalette verfügbar. Pulverbeschichtete Metallregale. Schwenkbares Keramikbecken mit verstellbaren Gelenken. Optionaler elektrische Beinlifte und/oder Vibrierende Massage.

Respaldo, asiento y apoyabrazos en poliuretano espumado con estructura de madera y metal. Revestimientos skai a elección. Estantes multifunciones en metal barnizado en electroforesis. Lavabo en porcelana oscilante con articulación ajustable. Posibilidad levantapiernas eléctrico y/o vibro masaje.

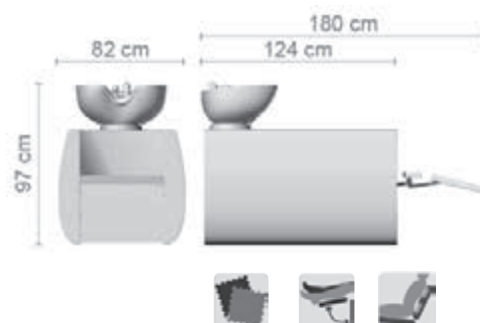



SEA

G5406N - SEA



LAGUNA

G7302 - LAGUNA



GOLFO

G7105

G7300 - GOLFO



G57143NSN



NOVI colonna

Schienale e seduta in poliuretano schiumato con inserti in legno multistrato e metallo. Rivestimenti skai a scelta. Basi: girevole in alluminio o con pompa idraulica con freno.

Backrest and seat in polyurethane foam on metal and multilayer wooden chassis. Wide skai colour range available. Aluminium base, with swivel mechanism or with hydraulic pump and brake.

Dossier et assise en mousse de polyuréthane avec des parties en bois multicouche et métal. Revêtement en skai à choisir. Bases pivotantes en aluminium ou avec pompe hydraulique avec frein.

Silla con respaldo asiento y apoyabrazos en poliuretano espumado y estructura multicapa de madera y metal. Revestimientos skai a elección. Bases de aluminio, giratorias o con bomba hidráulica y freno.



G57143



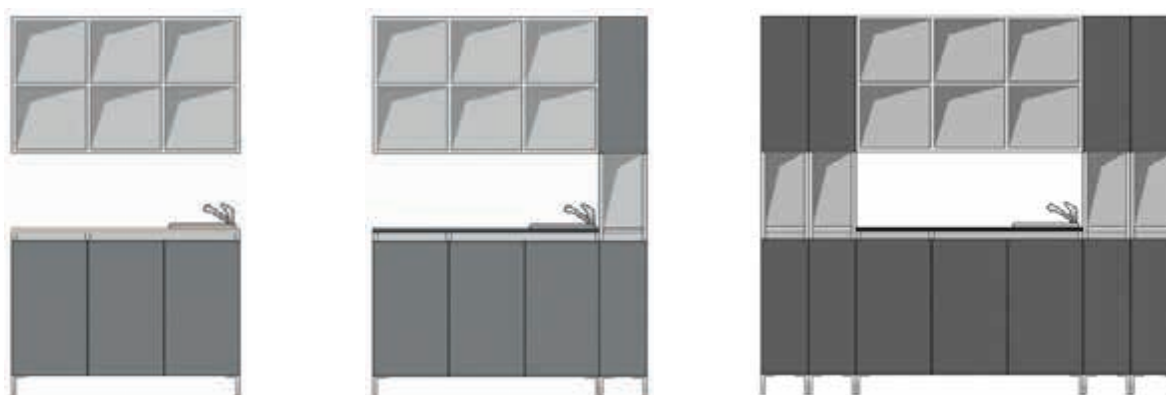
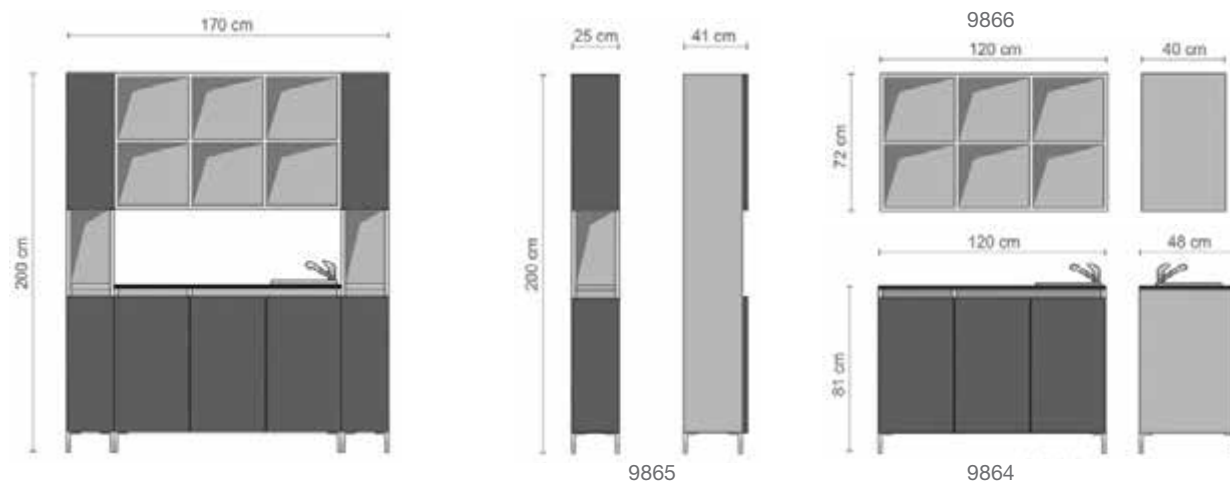

Esempi di composizione

MOBILE LABORATORIO

Laboratorio componibile: struttura in nobilitato con ante in laminato (finiture a scelta). Piano di lavoro in HPL (resistente all'acqua) completo di lavello in acciaio inox con rubinetteria. Piedi di appoggio in alluminio pressofuso lucidato e satinato.

Modular laboratory: structure in melamine with laminate doors (wide range of finishes available). HPL worktop (water resistant) with stainless steel sink and taps. Support feet in die-cast aluminium, polished and glazed.

Laboratoire modulaire: structure en mélamine avec des portes en stratifié (large gamme de finitions disponibles). Plan de travail en HPL (résistant à l'eau) avec cuvette en acier inoxydable et robinets. Pieds de support en aluminium moulé sous pression, poli et givré.

Modular Labor: Struktur in Melamin mit Laminat Türen (breite Palette von Ausführungen zur Verfügung). HPL Arbeitsplatte (wasserfest) mit Spüle und Wasserhähnen aus Edelstahl. Stützfüße aus Aluminiumdruckguss, poliert und satiniert.

Laboratorio modular: estructura en melamina con puertas en laminado (amplia gama de acabados disponibles). Mesa de trabajo en HPL (resistente al agua) con lavabo y grifería de acero inoxidable. Soportes en aluminio fundido a presión, pulido y satinado.





DIVANETTI

SOFAS

MODO pag 160

**AMBIENTE
TAORMINA** pag 162

ATTESA pag 164

MOMENTO pag 165

STAND BY pag 166

GOSSIP pag 167

CASABLANCA

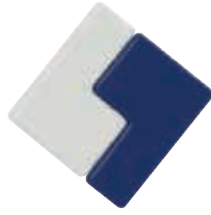

G61121



MOD0

Seduta in poliuretano schiumato con inserto in legno. Piedi di appoggio in alluminio pressofuso. Rivestimenti skai a scelta.

Seat in polyurethane foam on a wooden chassis. Supports in die-cast aluminium. Wide skai colour range available.

Assise en polyuréthane avec des parties en bois. Pieds en aluminium moulé sous pression. Revêtement en skai à choisir.

Sitz in Polyurethan mit Holzteilen. Füße aus Aluminiumdruckguss. Breite Palette von Ausführungen verfügbar.

Asiento de poliuretano espumado con estructura de madera. Patas de aluminio fundido a presión. Revestimientos skai a elección.







TAORMINA



ATTESA

Monoscocca in polipropilene stampata ad iniezione. Cuscino in poliuretano schiumato con inserto in legno multistrato. Piedi di appoggio in fibra di vetro bianco o nero. Rivestimenti skai a scelta.

Polypropylene monocoque, made by injection molding. Foamed polyurethane cushion with multilayer wood insert. Fiberglass supports, white or black. Wide skai colour range available.

Monocoque en polypropylène moulée par injection. Coussin en mousse de polyuréthane avec insert en bois multicouche. Pieds en fibre de verre blanche ou noire. Revêtement en skai à choisir.

Polypropylen-Monocoque, im Spritzgussverfahren hergestellt. Geschäumtes Polyurethankissen mit mehrlagigem Holzeinsatz. Füße in weißem oder schwarzem Fiberglas. Breite Palette von Ausführungen verfügbar.

Monocasco de polipropileno hecho a inyección. Cojín de espuma de poliuretano con inserción de madera multicapa. Patas en fibra de vidrio blanca o negra. Revestimientos skai a elección.

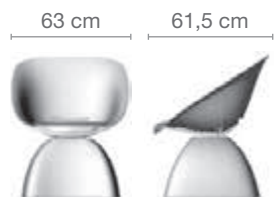

○ ●
Colori / Colours



G61155NSN

G61155B



G61153



MOMENTO

Seduta in poliuretano schiumato con inserto in legno. Piedi di appoggio in fibra di vetro bianco o nero. Rivestimenti skai a scelta.

Seat in polyurethane foam on a wooden chassis. Fiberglass supports, white or black. Wide skai colour range available.

Assise en polyuréthane avec des parties en bois. Pieds en fibre de verre blanche ou noire. Revêtement en skai à choisir.

Sitz in Polyurethan mit Holzteilen. Füße in weißem oder schwarzem Fibreglas. Breite Palette von Ausführungen verfügbar.

Asiento en poliuretano espumado con estructura de madera. Patas en fibra de vidrio blanca o negra. Revestimientos skai a elección.



G61153SN

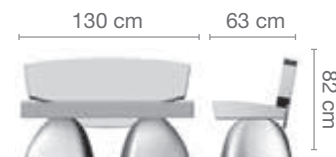



STAND BY

Seduta in poliuretano schiumato con inserto in legno. Piedi di appoggio in alluminio pressofuso. Rivestimenti skai a scelta.

Seat in polyurethane foam on a wooden chassis. Supports in die-cast aluminium. Wide skai colour range available.

Assise en polyuréthane avec des parties en bois. Pieds en aluminium moulé sous pression. Revêtement en skai à choisir.

Sitz in Polyurethan mit Holzteilen. Füße aus Aluminiumdruckguss. Breite Palette von Ausführungen verfügbar.

Asiento de poliuretano espumado con estructura de madera. Patas de aluminio fundido a presión. Revestimientos skai a elección.

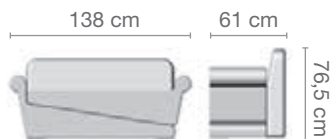

G61132





G60162



G61062

GOSSIP

Seduta in poliuretano schiumato con inserto in legno. Piedi di appoggio in alluminio pressofuso. Rivestimenti skai a scelta. Possibilità versione con pianetanette portacasco due posti.

Seat in polyurethane foam on a wooden chassis. Supports in die-cast aluminium. Wide skai colour range available. Optional supports for hood dryers.

Assise en polyuréthane avec des parties en bois. Pieds en aluminium moulé sous pression. Revêtement en skai à choisir. Supports pour casques en option.

Sitz in Polyurethan mit Holzteilen. Füße aus Aluminiumdruckguss. Breite Palette von Ausführungen verfügbar. Optionale Unterstützung für Trockenhaube.

Asiento en poliuretano espumado con estructura de madera. Revestimientos skai a elección. Patas de aluminio fundido a presión pulido. Barras portasecadores de casco opcionales.

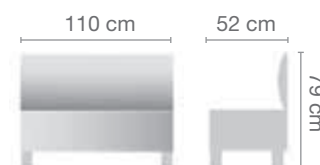





CASSE

RECEPTIONS

VOLUME pag 170

STONE pag 172

SHANGAI pag 174

SHOP pag 175

AMYRA pag 176

HALL pag 178

MEETING pag 180

CURVY pag 182

AMBIENTE LISBONA pag 184

COUNTER pag 186

BI-SIDE pag 188

PARIGI



VOLUME



P9926



P9926S

Struttura in nobilitato bianco/nero. Cassetti con chiave e vani a giorno. Finiture a scelta.

Melamine structure, in white and black, with drawers and open compartments. Wide range of finishes available.

Structure en melamine blanc et noir avec tiroirs avec clé et compartiments ouverts. Large gamme de finitions disponibles.

Melaminstruktur, in weiß und schwarz, mit Schubladen und offene Fächer. Breite Palette von Ausführungen verfügbar.

Estructura de melamina blanca y negra con cajones y compartimientos abiertos. Amplia gama de acabados disponibles.

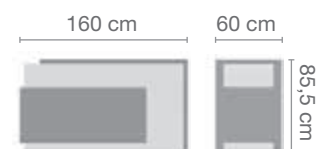



P9927

STONE

The Theatre



Struttura in nobilitato nero. Frontale in laminato nero con inserti retro-illuminati. Cassetto con chiave e vano a giorno. Finiture a scelta.

Black melamine structure. Front panel in black laminated wood with backlit inserts. Drawer with lock and open compartment. Wide range of finishes available.

Structure en mélamine noire. Panneau frontal en bois stratifié noire avec inserts rétro-éclairés. Tirroir avec clé et compartiment ouvert. Large gamme de finitions disponibles.

Struktur aus schwarzem Melamin. Frontplatte aus schwarz laminiertem Holz mit hinterleuchteten Einsätzen. Schublade mit Schloss und offenem Fach. Breite Palette von Ausführungen verfügbar.

Estructura de melamina negra. Panel frontal en madera laminada negra con inserciones retroiluminadas. Cajón con cerradura y compartimento abierto. Amplia gama de acabados disponibles.

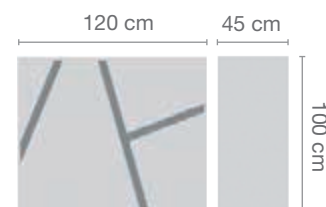



SHANGAI

Struttura in nobilitato bianco. Frontale in metallo verniciato in elettroforesi con inserti retroilluminati. Cassetto con chiave e vano a giorno. Finiture a scelta.

White melamine structure. Front panel in electrocoated metal with back-lit inserts. Drawer with lock and open compartment. Wide range of finishes available.

Structure en mélamine blanche. Panneau frontal en métal peint en électrophorèse avec inserts rétro-éclairés. Tiroir avec clé et compartiment ouvert. Large gamme de finitions disponibles.

Struktur aus weißem Melamin. Frontplatte aus pulverbeschichtetem Metall mit hinterleuchteten Einsätzen. Schublade mit Schloss und offenem Fach. Breite Palette von Ausführungen verfügbar.

Estructura de melamina blanca. Panel frontal en metal barnizado en electroforesis con inserciones retroiluminadas. Cajón con cerradura y compartimento abierto. Amplia gama de acabados disponibles.

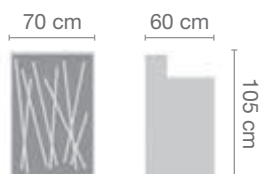

G9913S



G9936

SHOP

Struttura in nobilitato bianco con cassetto con chiave e vano a giorno. Finiture a scelta.

White melamine structure. Drawer with lock and open compartment. Wide range of finishes available.

Structure en mélamine blanche. Tiroir avec clé et compartiment ouvert. Large gamme de finitions disponibles.

Struktur aus weißem Melamin. Schublade mit Schloss und offenem Fach. Breite Palette von Ausführungen verfügbar.

Estructura de melamina blanca. Cajón con cerradura y compartimento abierto. Amplia gama de acabados disponibles.

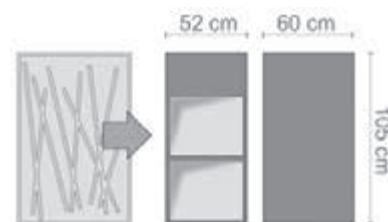



P9911SN

AMYRA



P9911

Struttura in vetroresina bianco o nero. Piani in vetro e laminato. Cassetto con chiave e vano a giorno. Finiture a scelta.

Fiberglass structure, white or black. Laminated wood and glass worktop. Drawer with lock and open compartment. Wide range of finishes available.

Structure en fibre de verre blanche ou noire. Top en bois stratifié et en verre. Tiroir avec clé et compartiment ouvert. Large gamme de finitions disponibles.

Fiberglas-Struktur, weiß oder schwarz. Arbeitsplatte aus laminiertem Holz und Glas. Schublade mit Schloss und offenem Fach. Breite Palette von Ausführungen verfügbar.

Estructura de fibra de vidrio blanca o negra. Estante en madera laminada y cristal. Cajon con llave y compartimento abierto. Amplia gama de acabados disponibles.





G9937S

HALL



Struttura in nobilitato bianco. Pannello frontale in nobilitato effetto “beton”. Cassetti con chiave e vani a giorno. Finiture a scelta.

White melamine structure. Front panel in “beton” effect melamine. Drawers with lock and open compartments. Wide range of finishes available.

Structure en melamine blanche. Panneau avant en mélamine effet “beton”. Tiroirs avec clé et compartiments ouverts. Large gamme de finitions disponible.

Struktur aus weißem Melamin. Frontplatte aus Melamin mit “Beton” Effekt. Schubladen und offene Fächer. Breite Palette von Ausführungen verfügbar.

Estructura de melamina blanca. Panel frontal en melamina efecto “beton” Cajones con llave y compartimientos abiertos. Amplia gama de acabados disponibles.

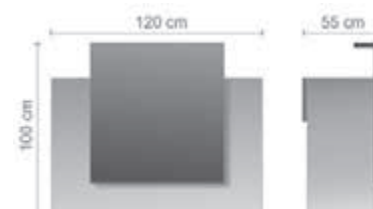



MEETING



P9909

Struttura in nobilitato bianco. Frontale in metallo verniciato in elettroforesi con inserti retroilluminati. Cassetti con chiave e vani a giorno. Finiture a scelta.

White melamine structure. Front panel in electrocoated metal with back-lit inserts. Drawers with lock and open compartments. Wide range of finishes available.

Structure en mélamine blanche. Panneau frontal en métal peint en électrophorèse avec inserts rétro-éclairés. Tiroirs avec clé et compartiments ouverts. Large gamme de finitions disponible.

Struktur aus weißem Melamin. Frontplatte aus schwarz laminiertem Holz mit hinterleuchteten Einsätzen. Schubladen und offene Fächer. Breite Palette von Ausführungen verfügbar.

Estructura de melamina blanca. Panel frontal en metal barnizado en electroforesis con inserciones retroiluminadas. Cajones con llave y compartimentos abiertos. Amplia gama de acabados disponibles.

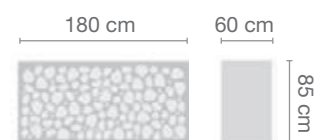

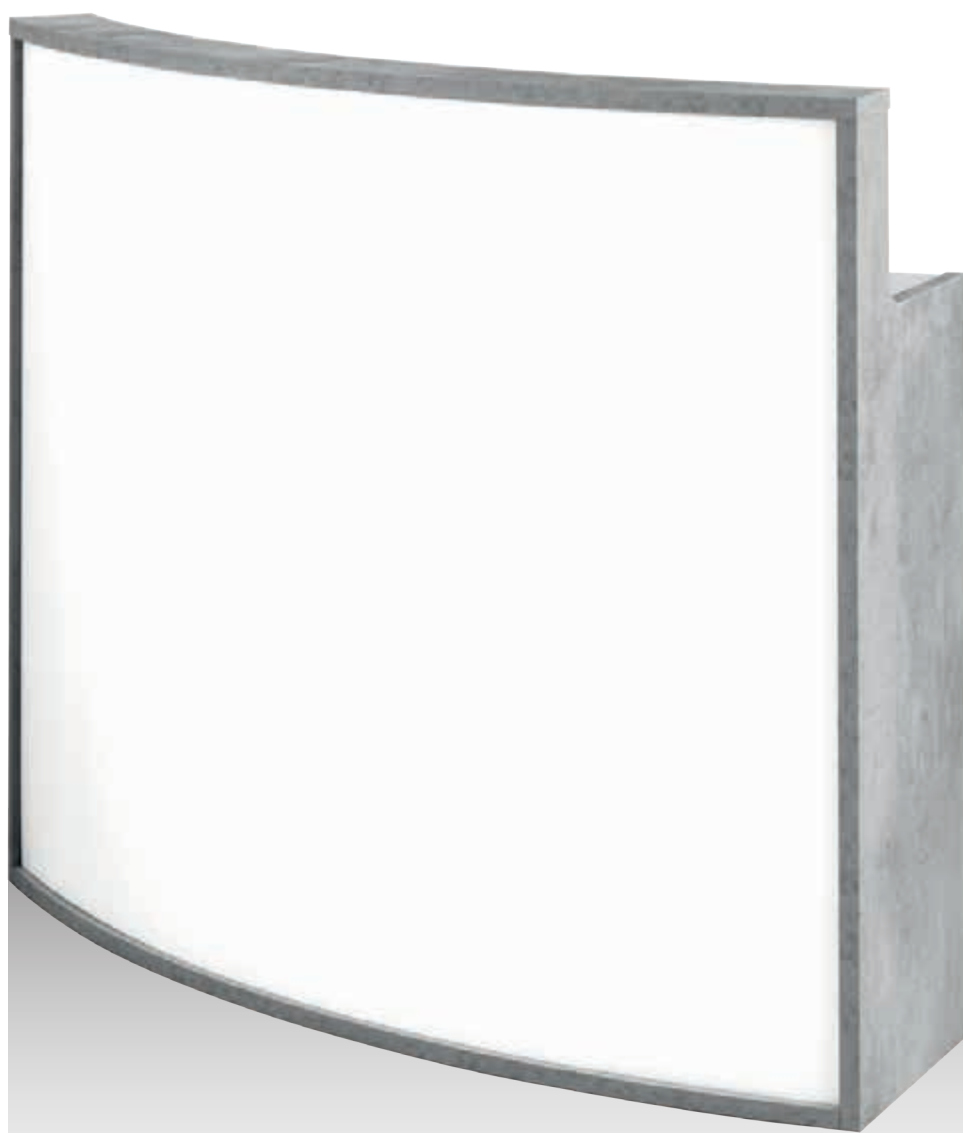

P9935S

CURVY



Struttura in nobilitato. Frontale in laminato bianco con inserti retro-illuminati. Cassetto con chiave e vano a giorno. Finiture a scelta.

Melamine structure. Front panel in white laminated wood with backlit inserts. Drawer with lock and open compartment. Wide range of finishes available.

Structure en mélamine. Panneau frontal en bois stratifié blanc avec inserts rétro-éclairés. Tiroir avec clé et compartiment ouvert. Large gamme de finitions disponibles.

Melaminstruktur. Frontplatte aus weißem Schichtholz mit hinterleuchteten Einsätzen. Schublade mit Schloss und offenem Fach. Breite Palette von Ausführungen verfügbar.

Estructura de melamina. Panel frontal en madera laminada blanca con inserciones retroiluminadas. Cajón con cerradura y compartimento abierto. Amplia gama de acabados disponibles.







LISBONA



G9929S



COUNTER

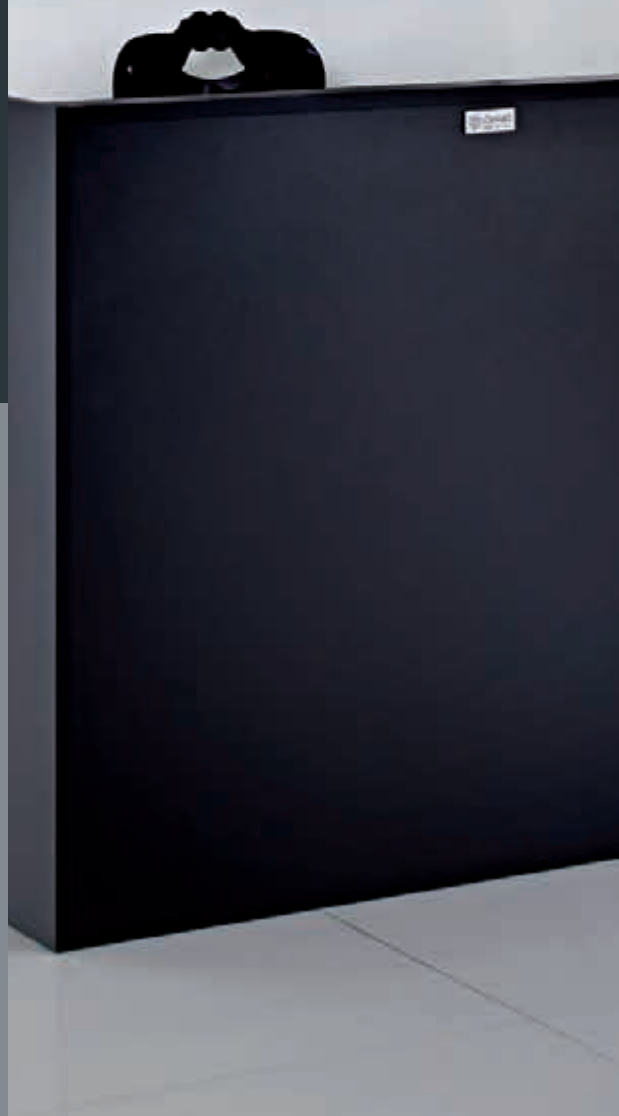

Struttura in nobilitato nero con cassetto e vano a giorno. Finiture a scelta.

Black melamine structure. Drawer with lock and open compartment. Wide range of finishes available.

Structure en mélamine noire. Tiroir avec clé et compartiment ouvert. Large gamme de finitions disponibles.

Struktur in schwarzem Melamin. Schublade mit Schloss und offenem Fach. Breite Palette von Ausführungen verfügbar.

Estructura de melamina negra. Cajón con cerradura y compartimento abierto. Amplia gama de acabados disponibles.

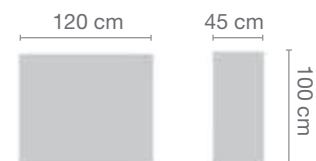

G9929





G9938



G9938

G9938S

BI-SIDE



Struttura in nobilitato bianco e nero. Cassetti con chiave e vani a giorno. Finiture a scelta.

Melamine structure, in white and black, with drawers and open compartments. Wide range of finishes available.

Structure en melamine blanc et noir avec tiroirs avec clé et compartiments ouverts. Large gamme de finitions disponibles.

Melaminstruktur, in weiß und schwarz, mit Schubladen und offene Fächer. Breite Palette von Ausführungen verfügbar.

Estructura de melamina blanca y negra con cajones y compartimentos abiertos. Amplia gama de acabados disponibles.





SKAI



YELLOW
MATT

D315



MELON
MATT

D607



ORANGE
MATT

D985



RED
MATT

D454



FUCHSIA
MATT

D381



DARK PURPLE
MATT

D354



COBALT BLUE
MATT

D453



STEEL BLUE
MATT

D581



LIME GREEN
MATT

D543



SILVER
SHINY

H101



WARM GRAY
MATT

D205



PURE BLACK
MATT

D195

SKAI



DIRTY WHITE
VELVET

D787



BEIGE
VELVET

D788



GRAY
VELVET

D789



BROWN
VELVET

D791



MAY GREEN
VELVET

D795



SOFT ROSE
VELVET

D797



DARK BLUE
VELVET

D798



SMOKE
VELVET

D792



PURE WHITE
MATT

D198



SAND
MATT

D210



DARK BEIGE
MATT

D311



DARK BROWN
MATT

D357



SKAI - S



3D
BEIGE

D070S



3D
BRONZE

D071S



3D
BROWN

D074S



3D
BLUE

D073S



3D
GRAY

D069S



DEEP
BLACK

D081S



QUILTED
BLACK

D096S



DEEP
BROWN

D080S



QUILTED
BROWN

D093S



KHAKI

D077S



QUILTED
KHAKI

D090S

SKAI - S



1950
WHITE

D180S



1950
BEIGE

D182S



1950
BROWN

D183S



1950
BLACK

D190S



1950
JEANS

D754S



1950
GRAY

D755S



COW SKIN

D148S



RAZZA
WHITE

D036S



RAZZA
BEIGE

D034S



RAZZA
BLAC

D046S



SUEDE
BLACK

D587S



SKAI - S



SOTEGA
WHITE

D646S



SOTEGA
BEIGE

D767S



BUTTERSCOTCH
50

D647S



BUTTERSCOTCH
100

D693S



SOTEGA
BROWN

D670S



BLOODY
RED

D680S



SOTEGA
PLUM

D126S



SOTEGA
GRAY

D676S



SUEDE
BLUE

D597S



BRONZE
SHINY

D999S



DAMASK
BLACK

D990S



DAMASK
GOLD

D111S

SKAI - S



SILVER
BRUSHED

D032S



LIGHT-GOLD
BRUSHED

D024S



ROSE-GOLD
BRUSHED

D025S



BROWN METAL
BRUSHED

D027S



FABRIC
LIGHT GRAY

D209S



FABRIC
ROSE

D203S



FABRIC
BROWN

D205S



POINTED
GOLD

D112S



KNIT
GOLD

D113S



FABRIC
LIGHT BLUE

D210S



FABRIC MEDIUM
BLUE

D211S



FINITURE



NOBILITATO OLMO FUMÈ
4521



NOBILITATO OLMO DEKAPÈ
4523

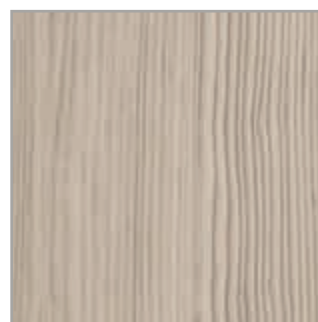

NOBILITATO OLMO ROSÈ
4522

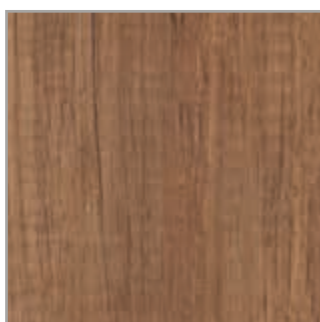

NOBILITATO SELECT 2
10587



NOBILITATO SELECT 1
10698

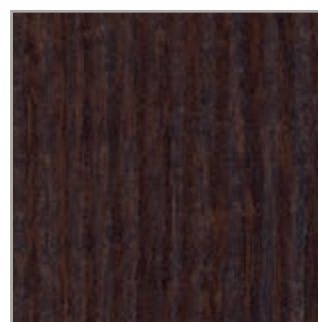

NOBILITATO WENGÈ
4519



NOBILITATO BETON
4520



NOBILITATO BIANCO
001



NOBILITATO NERO
002



LAMINATO LEGNO
003