

DATA LOGGERS

DATA LOGGER SYSTEMS FROM ROTRONIC

Wireless network

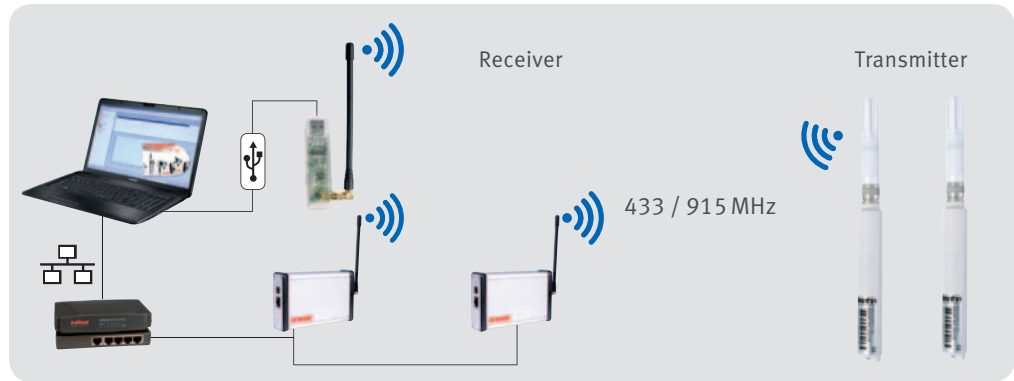

RS-485 network

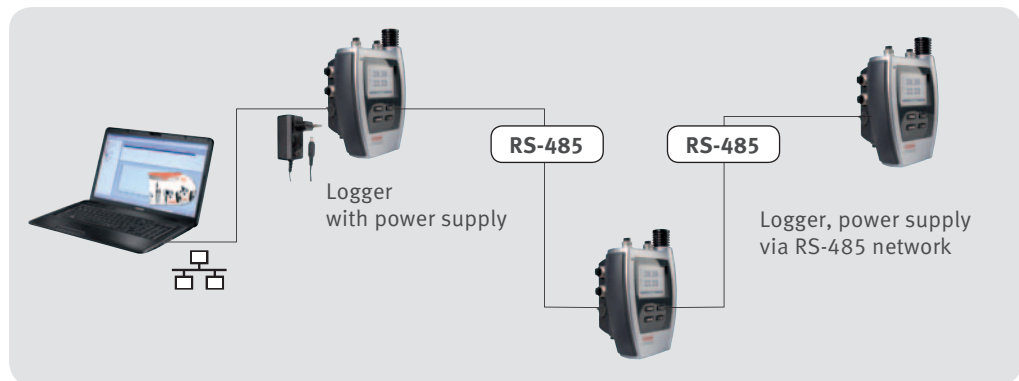

USB network

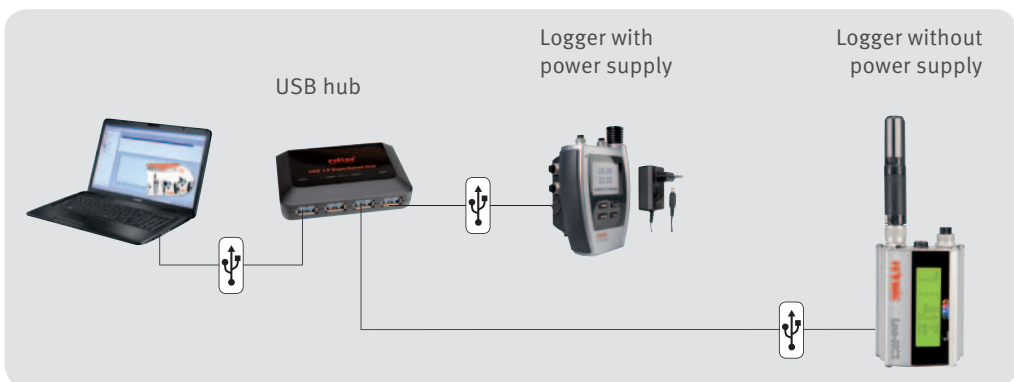

Ethernet network

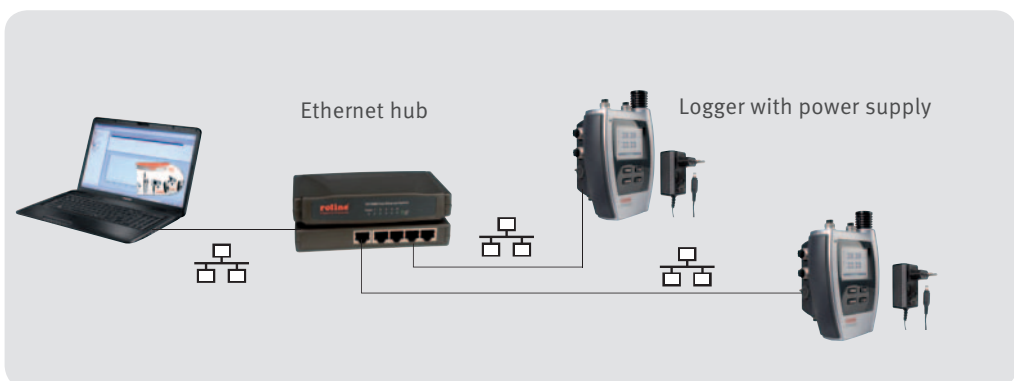

HYGROLOG SERIES – OVERVIEW 54

COMPACT LOGGER HYGROLOG HL20 55



UNIVERSAL LOGGERS LOG-HC2-P1/RO1 56



HIGH-END LOGGERS HYGROLOG HL-NT2 SERIES 57



HIGH-END LOGGERS HYGROLOG HL-NT3 SERIES 58



DOCKING STATIONS HYGROLOG HL-NT SERIES 59



ACCESSORIES FOR DATA LOGGERS 60





WIRELESS LOGGERS 61-63



HYGROLOG SERIES – OVERVIEW

The long-term recording of humidity and temperature conditions is very important in the pharmaceutical industry, production processes, storage, test facilities and many other areas. Once logged, the temperature and humidity data can be evaluated statistically. This provides valuable information on conditions that can have an influence on people and product quality. Wireless transmission saves wiring costs and simplifies and speeds up data transfer from inaccessible points.

ROTRONIC data loggers fulfill the requirements of 21 CFR Part 11 and GAMP5 completely. They are extremely accurate and easy to use. The data can be read out directly from the integrated flash card (HL-NT logger) or easily with the HW4 software. The data can be saved either in tamper-proof LOG mode or in easily accessible Excel files. The measured values can be monitored and stored securely online on a server or PC. A large range of interchangeable probes enables high flexibility in use and simple maintenance of the system.

	Compact	Universal	High-end	Wireless
				
	HL-20	LOG-HC2	HL-NT series	LOG-HC2-RC
Memory capacity	20,000	2,000,000	47,000 measured values per MB on memory card	500,000
Sensor	HYGROMER IN-1 / Pt100 Class A	Probe-dependent	Probe dependent	Probe-dependent
Range of application electronics	-10...60 °C	-20...65 °C	-30...70 °C (-10...60 °C, with display)	-40...85 °C
Calculations	Dew/Frost point	Customized calculations	All psychrometric parameters	Only in HW4
Integrated clock	Yes			
Power supply	3 AA batteries	USB / Rechargeable battery	9 V battery/Rechargeable battery/Mains	Integrated battery
Configurable logging interval	Yes			
Programmable alarms	Yes			
Interface	UART	USB	Docking station	Wireless
Conforms to 21 CFR Part 11 and GAMP5	Yes	No	Yes	No
Protection	IP40	IP60	IP40	IP65
CE / EMC compatibility: EMC Directive 2004/108/EC	Yes			

HYGROLOG HL20 humidity and temperature logger

The compact data logger for humidity and temperature measurement offers high precision and reliability at a reasonable price. The HL20 series is easy to use and suitable for a wide range of applications. Thanks to its integrated batteries, the HL20 provides hours of operation and offers its users maximum flexibility.

Applications

Warehouses, factories, museums, office buildings, clean rooms, shipping, libraries and test facilities

Features

- Range of application: -10...60 °C, 0...100 %RH
- 20,000 measured value pairs
- Accuracy at 23 °C ±5 K:
±0.8 %RH at 10...60 %RH / ±0.3 °C; ±1.3 %RH at 60...100 %RH / ±0.3 °C
- Freely selectable logging interval, 5 s...1 h
- Integrated clock with time stamp for every measurement
- Adjusted at 10, 35, 80 %RH and 23 °C
- Programmable visual alarms
- Battery operation



HL20 WITH DISPLAY

Order code	HL-20D
Device type	Autonomous data logger with display

HL20 SET WITH DISPLAY

Order code	HL-20D-SET
Device type	Autonomous data logger with display
Set consisting of	HL-20D, HW4 Lite software, connection cable AC3006

HL20 WITHOUT DISPLAY

Order code	HL-20
Device type	Autonomous data logger, without display

HL20 SET WITHOUT DISPLAY

Order code	HL-20-SET
Device type	Autonomous data logger, without display
Set consisting of	HL-20, HW4 Lite software, connection cable AC3006

INCLUDED

- Factory adjustment certificate, short instruction manual, 3 AA batteries
- Screw with plug for wall mounting

RECOMMENDED ACCESSORIES

• HW4 software	HW4 Lite
• PC connection cable	AC3006
• Calibration device	HL-20-CAL



UNIVERSAL LOGGERS LOG-HC2-P1



The rugged and compact data logger measures and records temperature, humidity, air pressure and light simultaneously. A four-line LCD with backlight and rechargeable battery ensures maximum performance combined with high ease of use. For mounting in switch cabinets and industrial environments, the logger can be attached to a top-hat rail.

Applications

Server rooms, production areas, shipping, aviation, residential and office rooms

Features

- 2,000,000 data point memory
- Range of applications electronics: -20...65 °C, 0...95 %RH
- Logging of measured data:
 - 2 interchangeable HC2 probes for relative humidity and temperature
 - Air pressure: 0...2000 mbar absolute
 - Illuminance: 0...65,000 lux
 - 3-axis acceleration / position: ±15 g
- Power supply: rechargeable lithium polymer battery with 2,300 mAh for long-term recording, chargeable via USB cable or AC adapter
- Logging interval: 1 s....12 h (two separate intervals can be set)
- Calculation of battery life with included software
- 4-line display with backlight to display the measured data
- LED status indicator (for recording, alarm and charge status)
- PC software for data evaluation and logger configuration
- Typical battery life: 535 days
 - based on this configuration:
 - Logging interval: 5 minutes
 - Measured data: 2 x humidity & temperature, air pressure, light and 3-axis acceleration
- Not compatible with HW4 software
- Interface (USB)
- Protection: IP60
- Dimensions: 61x77x36 mm



Order code	LOG-HC2-P1
Device type	Universal logger

INCLUDED

- AC adapter
- USB cable for connection to PC
- Software for PC connection for evaluation of the data and for logger configuration
- Short instruction manual
- Mounting plate

RECOMMENDED ACCESSORIES (ORDER PROBES SEPERATELY)

• Standard probe	HC2-S
• Industrial probe	HC2-IC102



HYGROLOG HL-NT3

The HL-NT3 has two additional external probe inputs. Further probes can be connected to the logger using an appropriate docking station.

Applications

Clean rooms, storerooms, server rooms, production areas, residential and office rooms, shipping

Features

- Two external probe inputs plus optional internal probe
- Saves 47,000 data records per MB card storage capacity
- Range of application: -30...70 °C (-10...60 °C, with display), 0...100 %RH
- Calculation of all psychrometric parameters
- Integrated clock with time stamp for every measured value
- Freely selectable logging interval, 5 s...24 h
- Power supply: 9 V (battery, rechargeable battery or docking station)
- Networkable with PC, via docking station (USB, RS-485, Ethernet, WLAN)
- Audible and visual alarms
- IP40

HYGROLOG NT3 with interchangeable probe and display

Order code	HL-NT3-DP
Device type	Data logger with 128 MB flash card, 2 external. probe inputs
Probe type	Interchangeable HC2-S probe, fitted internally



HYGROLOG NT3 with display, without probe

Order code	HL-NT3-D
Device type	Data logger with 128 MB flash card, 2 external. probe inputs
Probe type	Without probe, HC2 internal connection

HYGROLOG NT3 with interchangeable probe, without display

Order code	HL-NT3-P
Device type	Data logger with 128 MB flash card, 2 external. probe inputs
Probe type	Interchangeable HC2-S probe, fitted internally



HYGROLOG NT3 without display, without probe

Order code	HL-NT3
Device type	Data logger with 128 MB flash card, 2 external. probe inputs
Probe type	Without probe, HC2 internal connection

INCLUDED

- Flash card 128 MB, battery
- Short instruction manual
- Spare cap for probe
- Factory adjustment certificate
(for models with included probe)

RECOMMENDED ACCESSORIES

- | | |
|---|--------------------|
| • PC connection set, USB | Hygrodata-HL-E-USB |
| • USB docking station with 4 probe inputs | HL-DS-U2 |
| • Probe extension cable, 30 cm | E2-F3A |

DOCKING STATIONS FOR HYGROLOG NT

Depending on the model, the docking stations serve purely as a mounting bracket or offer additional functions such as, external power supply, interface module to a PC or network or extension module with digital or analog probe inputs as well as relay outputs.

Features

- Protection: IP40
- Range of application: -30...70 °C, 0...100 %RH

Overview docking stations

Order code	Inputs				Interfaces									
	External power supply	HygroClip2/Analog probe inputs	Analog input 0...2.5 V	Analog input 0(4)...20 mA	Digital inputs (switch contact)	Pt100 inputs	RS232 & RS-485	USB & RS-485	Ethernet TCP/IP RJ45 & RS-485	Ethernet TCP/IP RJ45	WLAN & RS-485	WLAN	Relay outputs	Use with Internet Browser *
HL-DS-NT0														
HL-DS-NT1	✓													
HL-DS-NT2	✓						✓							
HL-DS-NT3	✓						✓							
HL-DS-NT4	✓				2				✓					
HL-DS-NT4-WEB*	✓				2				✓					✓
HL-DS-NT4-WL	✓				2						✓			
HL-DS-PT2	✓				2	4		✓						
HL-DS-PT4	✓				2	2		✓						
HL-DS-PT4-WL	✓				2	2					✓			
HL-DS-R-1	✓				2			✓					2	
HL-DS-U1	✓	4	✓		2		✓							
HL-DS-U2	✓	4	✓		2			✓						
HL-DS-U2-420	✓	4		✓	2			✓						
HL-DS-U4	✓	4	✓		2				✓					
HL-DS-U4-420	✓	4		✓	2				✓					
HL-DS-U4-420-WEB*	✓	4		✓	2				✓					✓
HL-DS-U4-WEB*	✓	4	✓		2				✓					✓
HL-DS-U4-WEB-WL*	✓	2	✓		2							✓		✓
HL-DS-U4-WL	✓	2	✓		2						✓			✓

* WEB: Access to data logger without HW4 software possible via browser

RECOMMENDED ACCESSORIES

• Probe extension cable, 2 m, black	E2-02A
• AC adapter, 85...264 VAC to 12 VDC	AC1211-V1
• Cable to connect an analog probe (open ends)	A-02xx



HL-DS-U2



HL-DS-U4-WL

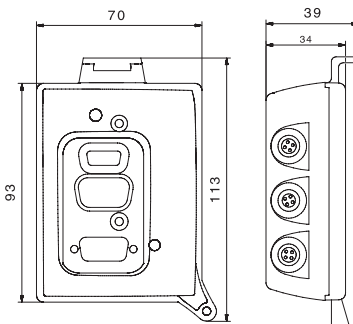

INCLUDED

- Screws for mounting
- Short instruction manual
- Configuration data sheet (LAN / WLAN docking stations)

ACCESSORIES FOR DATA LOGGERS AND DOCKING STATIONS

Order code	Description
AC adapter	
AC1211-V1	AC adapter for HygroLog NT docking stations, 240 VAC / 12 VDC
Connection sets	
Hygrodata-HL-E-USB	PC connection set, consisting of: HW4-E standard software, docking station HL-DS-NT3 and USB data cable
Hygrodata-HL-P-USB	PC connection set, consisting of: HW4-P professional software, docking station HL-DS-NT3 and USB data cable
HW4 software	
HW4-E-Vx	Standard software for programming and data management
HW4-P-Vx	Professional software with network and access control options and additional graphic functions
HW4-OPC-Vx	HW4-P with OPC server functionality
HW4-VAL	HW4-OPC with comprehensive validation documentation
Probe cables	
E2-F3A	Probe extension cable 30 cm, to prevent self-heating of the internal probe in loggers with connected Ethernet docking station
E2-01A	Probe extension cable for HC2 probes, 1 m, black
E3-01A	Probe extension cable for HC2 probes, 1 m, white
E2-02A	Probe extension cable for HC2 probes, 2 m, black
E3-02A	Probe extension cable for HC2 probes, 2 m, white
E2-05A	Probe extension cable for HC2 probes, 5 m, black
E3-05A	Probe extension cable for HC2 probes, 5 m, white
E2-02A-S	Probe extension cable for HC2 probes, 2 m, black, with short connector
E3-02A-S	Probe extension cable for HC2 probes, 2 m, white, with short connector
Communication cables	
AC0001	Standard Ethernet patch cable, 3 m, RJ45 connector
AC0002	Standard USB A/B cable, 1.8 m
AC0004	Standard RS232 cable, 1.8 m
AC0005	Ethernet patch cable, cat. 5e, unshielded twisted pair, 3 m, crossover
AC1614/02	RS-485 cable to HygroLog NT docking station, for cabling via terminal box - AC3021
Signal amplifier	
AC3003	Signal amplifier set for cable lengths up to 100 m. The set consists of: - 2 connection cables with electronic amplifier - open cable ends for connection via terminal box
Memory card	
AC-NT128MB	128 MB flash card, industrial type -40...85 °C
Other accessories	
DESK-NT	Desktop stand for HygroLog NT in combination with a docking station
ET-409	4-pin Binder connector, to connect Pt100 probes to selected docking station
AC0200	Rechargeable battery 9 V / 170 mA

AUTONOMOUS WIRELESS DATA LOGGERS

Wireless data loggers for a wide range of humidity and temperature monitoring tasks. Wireless transmission means you can save on the wiring costs and data can be sent to the system from inaccessible points. Thanks to the advanced secure data logging function, the data is not lost in the event of an interruption in wireless transmission and can be retrieved at any time.

Applications

Pharmaceutical and food industries, meteorology, environmental engineering, museums/glass cabinets, monitoring of storerooms, mechanical engineering, chemical industry, research and development

Features

- Interchangeable HC2 probes
- Radio frequency: 433.92 or 915 MHz for best penetration through brickwork and walls
- High storage capacity: up to 500,000 measured values with serial number, time and date
- Flash memory for data security in the case of power failures
- Long-term recording up to 6 years without battery replacement possible
- Transmission distance with USB wireless adapter: up to 100 m (free field)
- Data security: PIN (for activation and data access)
- Range of application: Electronics -40 to +85 °C, measuring range probe dependent.
- Plastic housing, white, IP65

WIRELESS HUMIDITY/TEMPERATURE DATA LOGGERS

Order code	Device type
LOG-HC2-RC	Standard version 433.92 MHz (HC2 probes must be ordered separately)
LOG-HC2-RC-US	USA version 915 MHz (HC2 probes must be ordered separately)

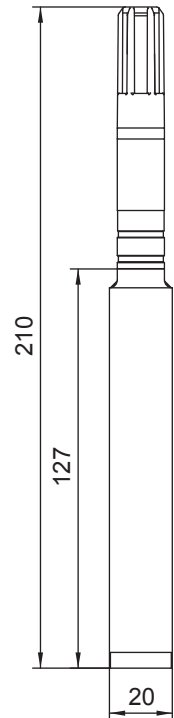

Specifications	LOG-HC2-RC
Type	Digital input for HC2 probes (UART)
Range of application	Electronics: -40...+85 °C Measuring range probe dependent
Radio frequency	433.92 MHz (US: 915 MHz)
Storage capacity	500,000 measured values
Logging interval	1 min. to 12 h
Power supply	Lithium battery 2400 mAh / 3.6 V
Battery life	Up to 6 years depending on logging interval and data transmission
Transmission distance	Max. 100 m (free field)
Data security	4-digit PIN (access code for activation/reading out)
Calibration / Adjustment	Via HW4 software and service cable AC3001
Dimensions without probe	140 mm x Ø 20 mm
Software	HW4 V3.2 or later

LAN INTERFACE

Applications

Using an existing Ethernet infrastructure and the wireless interface, remote data loggers can be accessed from any networked PC. The connection between the PC and the remote wireless logger is made via the LAN interface.

Features

- Manages up to 100 wireless data loggers at the same time
- Network connection: RJ-45 connector at a 100 MBit Ethernet LAN
- Wireless: SMA connector for external antenna
- Radio frequencies: 433.92 MHz (915 MHz for USA)
- Configurable via web browser
- Housing material: aluminum
- Power supply via AC adapter

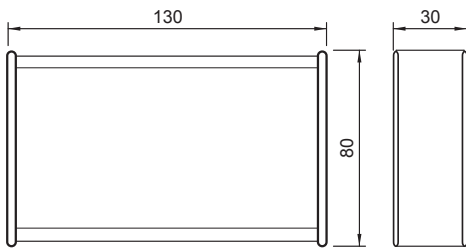

Order code	Device type
LAN-INTERFACE	433.92 MHz version with standard antenna
LAN-INTERFACE-US	915 MHz USA version with standard antenna

COMPATIBLE

- Wireless data loggers
- Ground plane antenna

INCLUDED

- Short instruction manual
- AC adapter

Specifications	LAN interface
Type	Network (Ethernet) readout device for wireless data loggers
Radio frequency	433.92 MHz (US: 915 MHz)
Power supply	Via mains adapter, 5 V, min. 500 mA
Transmission distance	Up to 100 m (with standard antenna) for short-range wireless communication at 433.92 / 915 MHz
Dimensions (H x L x W) without antenna	30 mm x 130 mm x 80 mm
Software	HW4 V3.2 or later

USB WIRELESS ADAPTER

Applications

The USB wireless adapter serves as an interface to a PC. For programming of and downloading data from wireless data loggers via HW4 software.

Features

- Programming and downloading data from wireless data loggers
- Radio frequency: 433.92 MHz or 915 MHz
- Interchangeable antenna
- Easy handling

Order code	Device type
LOG-DS-EXT	USB wireless adapter with interchangeable SMA antenna, standard version (433.92 MHz)
LOG-DS-EXT-US	USB wireless adapter with interchangeable SMA antenna, USA version (915 MHz)



Specifications	USB wireless adapter
Type	Local programming and interface device for wireless data loggers
Radio frequency	433.92 MHz (US: 915 MHz)
Power supply	USB power supply via PC
Transmission distance	Up to 100 m (w/ standard antenna) for short-range wireless communication at 433.92 / 915 MHz
Dimensions (H x L x W) without antenna	15 mm x 77 mm x 20 mm

ACCESSORIES

433 MHz GROUND PLANE ANTENNA

Features

- Industrial antenna for improved reception, higher range
- Suitable for use both indoors and outdoors
- Incl. 2.5 m coaxial cable (50 Ω) and SMA connector
- Dimensions (Ø x H): 190 mm x 460 mm

Order code	Device type
LOG-AN-GP433	433 MHz ground plane antenna, cable length 2.5 m

Note: Any antenna (Yagi, rod, etc.) with an SMA connector can be used.



COMPATIBLE

- Wireless data loggers
- Ground plane antenna

INCLUDED

- Short instruction manual