



DCell



DSC

DCell & DSC

Strain Gauge or Load Cell Embedded Digitiser Module MantraCAN - 2nd Generation

Software Version 3 onwards



User Manual
www.mantracourt.co.uk

ME mantracourt

Contents

Chapter 1 Introduction	4
Overview	4
Key Features.....	4
Special Facilities.....	5
Version 3 Additions and Enhancements.....	5
The Product Range	6
Which Device To Use	6
Additional DCell & DSC Variants Available	6
Some Application Examples.....	7
Chapter 2 Getting Started with the Evaluation Kit	8
The Evaluation Kit.....	8
Contents.....	8
Checking the Device Type.....	9
Connecting Up The Evaluation Kit	9
Initial Checks	9
Instrument Explorer	9
What Can Instrument Explorer Do?	9
Installing Instrument Explorer	9
Running the Instrument Explorer Software.....	10
Instrument Explorer Icon	10
Instrument Settings.....	11
Viewing Device Data	12
Instrument Explorer Parameter List	12
Connecting a Load Cell	13
DSJ1 Evaluation Board Sensor Connections	14
Performing A System Calibration	15
Chapter 3 Explanation of Category Items	20
Communications	20
ID, NODEIDL, NODEIDH.....	20
Example	20
CAN Bit Rate, BPS.....	21
Identifier Size, IDSIZE.....	21
CAN Bus, CANTXERR, CANRXERR, CANSTATUS	21
CANTXERR.....	21
CANRXERR.....	22
CANSTATUS	22
Streaming	22
Configuring Output Message Streams	22
Message Streams.....	22
Streaming Types, STRMTYPE.....	22
Starting and stopping Streaming, STRMON, STRMOFF	22
Message Configuration.....	23
Custom Start / Stop	24
Start Streaming	24
Stop Streaming	25
Data Types	26
Sub Formats	26
Message Output Examples.....	27
Streaming Start / Stop Examples	27
Information	27
Software Version, VER	27
Serial Number, SERL and SERH	27
Strain Gauge.....	28
mV/V output, MVV.....	28
Nominal mV/V level, NMVV	28
mV/V Output In Percentage Terms, ELEC	28

Temperature Value, TEMP	28
Output Rate Control, RATE	28
Dynamic Filtering, FFST and FFLV	28
Cell	30
Temperature Compensation In Brief	30
Cell Scaling, CGAI, COFS	30
Two Point Calibration Calculations and Examples	30
Calibration Methods	31
Cell Limits, CMIN, CMAX	31
Linearisation In Brief	32
System	32
System Scaling, SGAI, SOFS	32
Example of calculations for SGAI and SOFS	32
System Limits, SMIN, SMAX	33
System Zero, SZ	33
System Outputs, SYS, SOUT	33
Reading Snapshot, SNAP, SYSN	33
Control	34
Shunt Calibration Commands, SCON and SCOF	34
Digital Output, OPON and OPOF	34
Flags	34
Diagnostics Flags, FLAG and STAT	34
Latched Warning Flags (FLAG)	34
Meaning and Operation of Flags	35
Dynamic Status Flags (STAT)	36
Meaning and Operation of Flags	36
Output Update Tracking	36
User Storage	36
USR1...USR9	36
Reset	37
The Reset command, RST	37
WARNING: Finite Non-Volatile Memory Life	37
Chapter 4 The Readings Process	38
Flow diagram	38
Cell & System Scaling	39
Calibration Parameters Summary and Defaults	40
Chapter 5 Temperature Compensation	41
Purpose and Method of Temperature Compensation	41
Temperature Module Connections and Mounting (DTEMP)	41
Control Parameters	42
Internal Calculation	42
The Temperature Measurement	43
How to Set Up a Temperature Compensation	43
Parameter Calculations	44
Chapter 6 Linearity Compensation	45
Purpose and Method of Linearisation	45
Control Parameters	45
Internal Calculation	45
How to Set Up Linearity Compensation	46
Parameter Calculations and Example	46
Chapter 7 Self-Diagnostics	48
Diagnostics Flags	48
Diagnostics LED	48
Chapter 8 MantraCAN Communication Protocol	49
Basic Command Structure	49
Read	49
Example of Read	50
Write	50

Example of Write	51
Execute A Command	51
Example Of Execute A Command	51
Data Type Conversions and Rounding	52
Chapter 9 Software Command Reference	53
Commands in Access Order	53
Chapter 10 Installation	57
Before Installation.....	57
Physical Mounting.....	57
Electrical Protection	57
Moisture Protection	57
Soldering Methods	59
Power Supply Requirements	59
Cable Requirements.....	59
Strain Gauge input (DSC)	59
Power and Communication.....	59
Temperature Sensor.....	60
Identifying Strain Gauge Connections.....	60
DCell Input Connections	60
DSC Input Connections.....	60
Identifying Bus-End Connections	61
DCell Bus Connections	61
DSC CAN Versions-Bus Connections	61
Strain Gauge Cabling and Grounding Requirements	62
DCell Strain Gauge Wiring.....	62
DCell Strain Gauge Wiring Arrangement	62
Key Requirements	62
Key Requirements	62
Communications Cabling and Grounding Requirements.....	63
DCell Power and Communications Wiring	63
DCell Bus-End Arrangement.....	63
DSC4 Versions- Power and Communications Wiring.....	63
DSC4 Versions-Bus-End Arrangement	63
Key Requirements	63
Suitable Cable Types.....	64
DCell/DSC CAN Bus Cable	64
Indication Of Maximum Bus Length.....	64
CAN Bus Connections for Multiple DCells	65
CAN Bus Connections for Multiple DSC Versions.....	65
Key Requirements	66
Bus Layout and Termination	66
Loading	66
Strain Gauge Sensitivity Adjustment (DSC ONLY)	66
Identifying the DSC 'Rg' Resistor	66
Chapter 11 Troubleshooting	68
LED Indicator	68
No Communications	68
Bad Readings	68
Unexpected Warning Flags	69
Problems with Bus Baud Rate.....	69
Recovering a "lost" DCell/DSC	69
Resetting to default ID.....	69
First Command	69
Second Command.....	69
Chapter 12 Specifications.....	70
Technical Specifications DSC/DCELL High Stability.....	70
Technical Specifications DSC/DCELL Industrial Stability	71
Mechanical Specification for DSC	72

Mechanical Specification for DCell	72
CE Approvals.....	72

Chapter 1 Introduction

This chapter provides an introduction to DCell/DSC products, describing the product range, main features and application possibilities.

Overview

The DCell and DSC products are miniature, high-precision Strain Gauge Converters; converting a strain gauge sensor input to a CAN output. They allow multiple high precision measurements to be made over a low-cost 2-wire link. Outputs can be accessed directly by PLCs or computers, or connected via various types of network, all without compromising accuracy.

The device is configurable via a proprietary **MantraCAN** protocol but is able to stream data in a customisable manner to suit most CAN networks i.e. CANopen® or J1939.

This streamed data does not support any interaction, parameter writing or action commands. However all this can be achieved using the MantraCAN protocol.

Customisable start and stop messages allow the instrument streaming to be controlled via the host CAN network.

Key Features

Ultra-miniature

The DCell ‘puck’ format can be fitted inside most load cell pockets, and similar restricted spaces. The DSC cards are similarly very small, optimised for mounting as a component onto custom PCBs.

High-precision Industrial Version.

25ppm basic accuracy (equates to 16 bit resolution)

High-precision High Stability

5ppm basic accuracy (equates to 18 bit resolution) with comparable stability - far exceeds standard instrument performance.

Low-power

Low-voltage DC supply (5.6V min), typically 40mA for RS485 and 52mA for RS232 (including 350R strain gauge).

Adjustable sensitivity

Configured for standard 2.5mV/V full-scale strain gauges as supplied.

A single additional resistor configures the input between 0.5 and 100 mV/V full-scale.

Temperature sensing and compensation (optional)

An optional temperature sensor module is available and advanced 5-point temperature-compensation of measurement.

Linearity compensation

Advanced 7-point linearity compensation.

CAN Output

Lower-cost cabling, improved noise immunity, and longer cable runs with no accuracy penalty.

Device addressing allows up to 127 devices on a single bus, drastically reducing cabling cost and complexity.

Two-way communications allow in-situ re-calibration, multiple outputs and diagnostics.

No separate measuring instruments needed.

Digital calibration

Completely drift-free, adjustable in-system and/or in-situ via standard communications link.

Two independent calibration stages for load cell-and-system-specific adjustments.

Programmable compensation for non-linearity and temperature corrections.

Calibration data is also transferable between devices for in-service replacement.

Self-diagnostics

Continuous monitoring for faults such as strain overload, over/under-temperature, broken sensors or unexpected power failure.

All fault warnings are retained on power-fail.

Special Facilities

Output Capture Synchronisation

A single command instructs all devices on a bus to sample their inputs simultaneously, for synchronised data capture.

Output Tare Value

An internal control allows removal of an arbitrary output offset, enabling independent readings of net and gross measurement values.

Dynamic Filtering

Gives higher accuracy on stable inputs, without increased settling time.

Programmable Output Modes

Output rate control enables speed/accuracy trade-off.

ASCII output version provides decimal format control and continuous output mode for 'dumb terminal' output.

Unique Serial Number

Every unit carries a unique serial-number tag, readable over the communications link.

Communications Error Detection

CAN transmit and receive error counts along with CAN bus status can be read from the device.

External Temperature Sensing (optional)

An external temperature module for improved accuracy (especially tracking changing temperature conditions).

Software Reset

A special communications command forces a device reboot, as a failsafe to ensure correct operation.

Version 3 Additions and Enhancements

The following are an outline only more detail will be found further on in this manual

DCell

- Easy mounting via a 2mm screw
- Connection via solder holes to either side of PCB
- Lower profile, dual PCB construction

DSC

- Additional I/O
- Easier shielding connection at load cell connector end

DCell & DSC

- Bit rates to 1 Mbps
- Higher sampling rate. Sampling to 200Hz can now be achieved. Also more sampling rates are available as follows 1, 2, 5, 10, 20, 50, 60, 100 & 200Hz
- Lower cost. With new technology and further use of miniaturisation the cost is now lower
- Real mV/V calibration. Instead of % full scale the base measurement is in mV/V and is factory calibrated to within 0.1%. the % of FS output "ELEC" is still available
- Extreme Noise Immunity, 5 x heavy industrial level
- Diagnostics LED. An LED is used to indicate that the device is powered and working correctly. The LED is also used to indicate which protocol the device is
- Remote shunt cal. A 100K 1% 50ppm/Deg C resistor can be switched across the bridge to allow load cell integrity to be established
- Peak & Trough Measurements. Added to allow the faster rates to hold a peak or trough readings. These are stored in volatile memory & are therefore reset on power up
- Programmable dynamic filtering. The filtering is the same as used on Version 2 but with the advantage of being able to set the characteristics using the communications

- Wide Operating Voltage. The operating voltage is now 5.5 to 18V allowing the device to be powered from a wider range of available system supplies
- DC Excitation. DC excitation has now been employed allowing longer cable lengths for the load cells which is particularly useful for DSC. This is a 4-wire measurement
- Scaling implementation has been changed for both “CELL” and “SYS”. The gain is applied before the offset thus following the more standard approach. This allows for an offset change to be made easily as the offset is not a component of gain

The Product Range

Devices are available in two physical formats:



The **DCell** (puck) products consist of a Digital Strain Gauge Signal Conditioner with CAN bus output in double sided component population format.

This is suitable for installation in very small spaces, including load cell pockets.

External connections are made by wiring to through hole pads.

Mounting is via a 2mm mounting hole to accept M2 screw or American equivalent #0-80. Important Note: DO NOT USE #2 screw size.



The **DSC** (card) products are very similar to the DCell but in a different physical form for mounting stand-alone or on a board.

External connections are via header pins which can plug into connectors, or be soldered to wires or into a host PCB. DSC has an open collector output and volt free digital input.

Which Device To Use

It is important to select the correct product for your application.

First choose DCell or DSC based on your physical installation needs

Common Features

Both physical formats offer identical control and near-identical measurement performance

Differences

Only the DSC (card) is available with digital Input & output.

Special Aspects To Consider

The DCell fits neatly into a strain gauge pocket

The DSC lends itself to PCB mounting

Additional DCell & DSC Variants Available

A separate variant is available with RS232 or RS485 output. Refer to DCell & DSC CAN - 2nd Generation - Manual. (These variants are sufficiently different to require their own manuals)

The following order codes are supported by an earlier version manual ‘DCell & DSC Version 2’

DLCPKASC, DLCPKMAN, DLCPKMOD, DSC2AS, DSC2MA, DSC2MB, DSC4AS, DSC4MA, DSC4MB

Some Application Examples

Simple Distributed Measurement

Pressure loads are taken at a number of key points in a manufacturing process, distributed over a large area. Each pressure sensor contains a DCell unit, and all the sensors are connected by a single cable carrying power and CAN communications. A central PC allows continuous display, monitoring and logging of all values from a central control room. This displays a control-panel and current display window, and logs information to an Excel spreadsheet for future analysis.

Further monitoring checks and displayed information can easily be added when required to the system where up to 127 'nodes' can be installed.

Low Cost Dedicated Weighing Station

A basic load cell weighing-pad device has a cable leading to a wall mounted weight display.

Digital Load Cell

Load cell products are offered with a high-precision digital communications option.

A DCell is fitted into the gauge pocket of each load cell in manufacture. During product testing, each unit undergoes a combined load test and temperature cycle. Each unit is then programmed with individually calculated gain, offset, linearity and temperature compensation tables. All units perform to a very tight specification without the use of any trimming components.

High Reliability Load sensing

A road bridge has a dedicated load monitoring and active control computer system. System calibration adjustments are only established during construction, so sensors must be replaceable without recalibration.

Each load monitoring point has a digital load cell fitted, with calibration values set during construction. Self-diagnostics aid detection of failures.

When a failed load cell is replaced it will produce identical force measurements. The old load cell set-up data values are programmed into the separate user-level calibration store in the unit, to produce an identically performing replacement.

Load Balance Monitor

A lorry loading weighpoint monitors left/right load balance and sounds a warning if loading is too uneven for safety.

A drive-on weighing platform is provided with load cells at each of four corners. Each cell is wired to a DSC unit, and these are cabled to a 3rd party LCD display and control unit, producing a complete turnkey system. A digital I/O card is wired to the same bus to control the warning alarm. Application software running on the control unit provides a % left/right balance readout with a graphical tipping display, and a total weight indication.

The balance indication is calculated by comparing the different corner readings. If it exceeds a programmed limit, a command to the I/O card turns the relay on.

Total weight is calculated by summing the individual results mathematically.

Automatic re-zeroing occurs when the total is near zero for more than a few seconds.

A control button enables a set-up mode for recalibration (protected by operator password), which displays individual readings and total. Corner compensation can be checked by observing the changing total as a weight is moved around. Simple button presses control two point recalibration for any cell.

Chapter 2 Getting Started with the Evaluation Kit

This chapter explains how to connect up a DCell/DSC for the first time and how to get it working. For simplicity, this chapter is based on the standard DCell/DSC Evaluation Kit, which contains everything needed to communicate with a puck or card from your PC.

It is advised that first time users wishing to familiarise themselves with the product use the Mantracourt Evaluation Kit. This provides a low cost, easy way to get started.

If you do not have an Evaluation Kit, the instructions in this chapter mostly still apply, but you will need to wire up the device (and possible bus-converter) and have some means of communicating with it.

The Evaluation Kit

Contents

- An Evaluation PCB (DSJ1) which comprises of
 - A 8 way screw connector for the strain gauge & Temperature sensor
 - A 5 way screw connector for power & CAN comms
 - A 9 way 'D'Type for direct CAN (limited to 500Kbps)
 - Link headers for CAN, RS232 or RS485 comms selection
 - Terminating resistor for CAN & RS485
 - LED for power indication
 - LED for digital output (DSC only)
 - Push Switch for digital input (DSC only)
- An Evaluation DCell or DSC of your choice
- A CD ROM containing Instrument Explorer software
- A 9 way 'D'Type extension lead
- A USB-CAN converter
- DTEMP temperature sensor for temperature compensation evaluation



Other Things you will need

- A regulated power supply, capable of providing 5.6 -18V at 100mA
 - A PC running Windows 98 or above, with a spare USB port and 45Mb free disk space
- and, ideally
- A strain gauge, load cell or simulator, 350-5000 ohms impedance

Checking the Device Type

For a DCell, the Product Code is one of the following 2 types

DLCSMCAN	Industrial Stability MantraCAN output
DLCHMCAN	High Stability MantraCAN output

For a DSC card, the Product Code is one of the following 2 types

DSCSMCAN	Industrial Stability MantraCAN output
DSCHMCAN	High Stability MantraCAN output

The CAN bus Identifier ID of a New DCell/DSC device is factory set to 1

This can be changed if required but for ease of evaluating it is suggested that you use this default value.

Connecting Up The Evaluation Kit

Power is supplied to the DSJ1 via the 5 way connector (J1). This is connected to a supply set between 5.6v and 18v DC. The red wire being positive and the black negative. The CAN is connected using the 9 way D-type extension lead to J3 and to the USB-CAN converter.

Ensure LK1 & LK5 are set to "CAN/RS485". Fit LK2 which terminates the CAN bus.

Switch on, the Green Power LED of the DSJ1 should be on.

Initial Checks

With no load cell connected The LED of the DCell or DSC should flash OFF for 100ms every 0.5s.

Note: If a Load cell is connected and there are no errors then the LED will Flash ON for 100mS then Off for the above period. This being the normal healthy state.

Another check that the device is working okay is by noting the current drawn from the supply, this should be about 40mA.

Instrument Explorer

Instrument Explorer is Mantracourts own communication interface for our range of standard products. It provides communications drivers for the DCell/DSC products. A complimentary copy is provided on CD-ROM with the DCell/DSC Evaluation Kit. Instrument Explorer can also be downloaded from Mantracourts website.

http://www.mantracourt.co.uk/software/Instrument_Explorer

Instrument Explorer is a software application that enables communication with Mantracourt Electronics instrumentation for configuration, calibration, acquisition and testing purposes.

The clean, contemporary interface allows full customisation to enable your Instrument Explorer to be moulded to your individual requirements.

What Can Instrument Explorer Do?

- Save and restore customisable user workspace
- Read and Write individual instrument parameters
- Save and restore parameter configurations
- Log data to a window or file
- Perform calibration and compensation
-

Installing Instrument Explorer

Install the Instrument Explorer software by inserting the CD in the CD ROM drive. This should start the 'AutoRun' process, unless this is disabled on your computer.

(If the install program does not start of its own accord, run SETUP.EXE on the CD by selecting 'Run' from the 'Start Menu' and then entering D:\SETUP, where D is the drive letter of your CD-ROM drive).

The install program provides step-by-step instructions. The software will install into a folder called *InstrumentExplorer* inside the *Program Files* folder. You may change this destination if required.

Shortcut icons can be created on your desktop and shortcut bar. After installation you may be asked to restart the computer. This should be done before proceeding with communications.

When given the option to install IXXAT CAN drivers ensure these are selected, which is the default.

Running the Instrument Explorer Software

Having installed Instrument Explorer you can now run the application, which the rest of this chapter is based around.

From the Windows 'Start' button, select *Programs*, then *Instrument Explorer* or click on the shortcut on your desktop.

Instrument Explorer Icon



The application should open and look like the following screen shot. Instrument Explorer Window

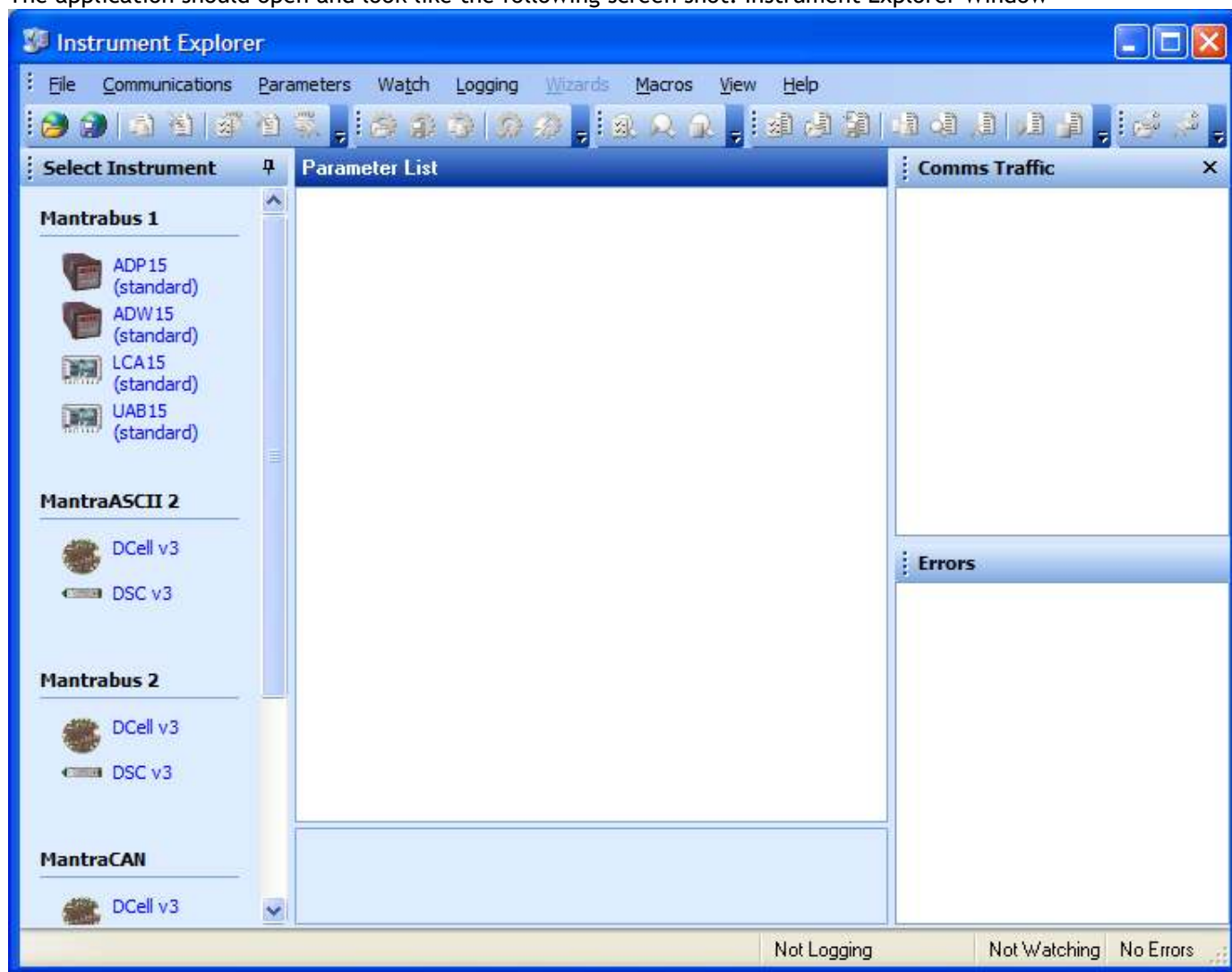

The layout of Instrument Explorers Window and child windows allows the user full customisation to their requirements. If the application show a different arrangement of child windows than the above screen shot then using then load one of the default workspaces as follows:

Click **File** on the menu and select **Open Workspace**. From the file dialogue window select **Layout - Standard.iew**. This will ensure your application layout matches this document.
A list of available instruments is displayed in the Select Instrument pane of Instrument Explorer. Select the relevant device by clicking on the required device icon under the MantraCAN heading.

Instrument Settings

MantraCAN

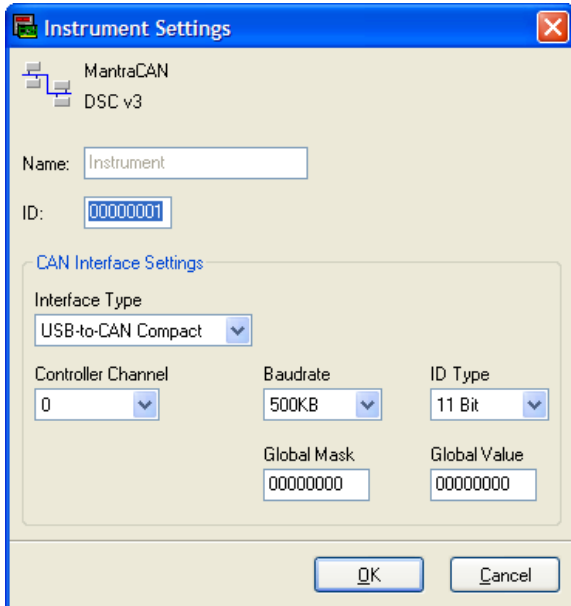

- Select the ID. The factory default is **1**
- Select the baud rate to which the device is set. The factory default is **500KB**
- Select the ID type. Default is 11Bit (standard)
- Now click the 'OK' button...

The above assumes factory defaults. If your device is known to have different settings use these instead of the ones stated above.

Viewing Device Data

The following main parameter list should now appear in the central pane.

Instrument Explorer Parameter List

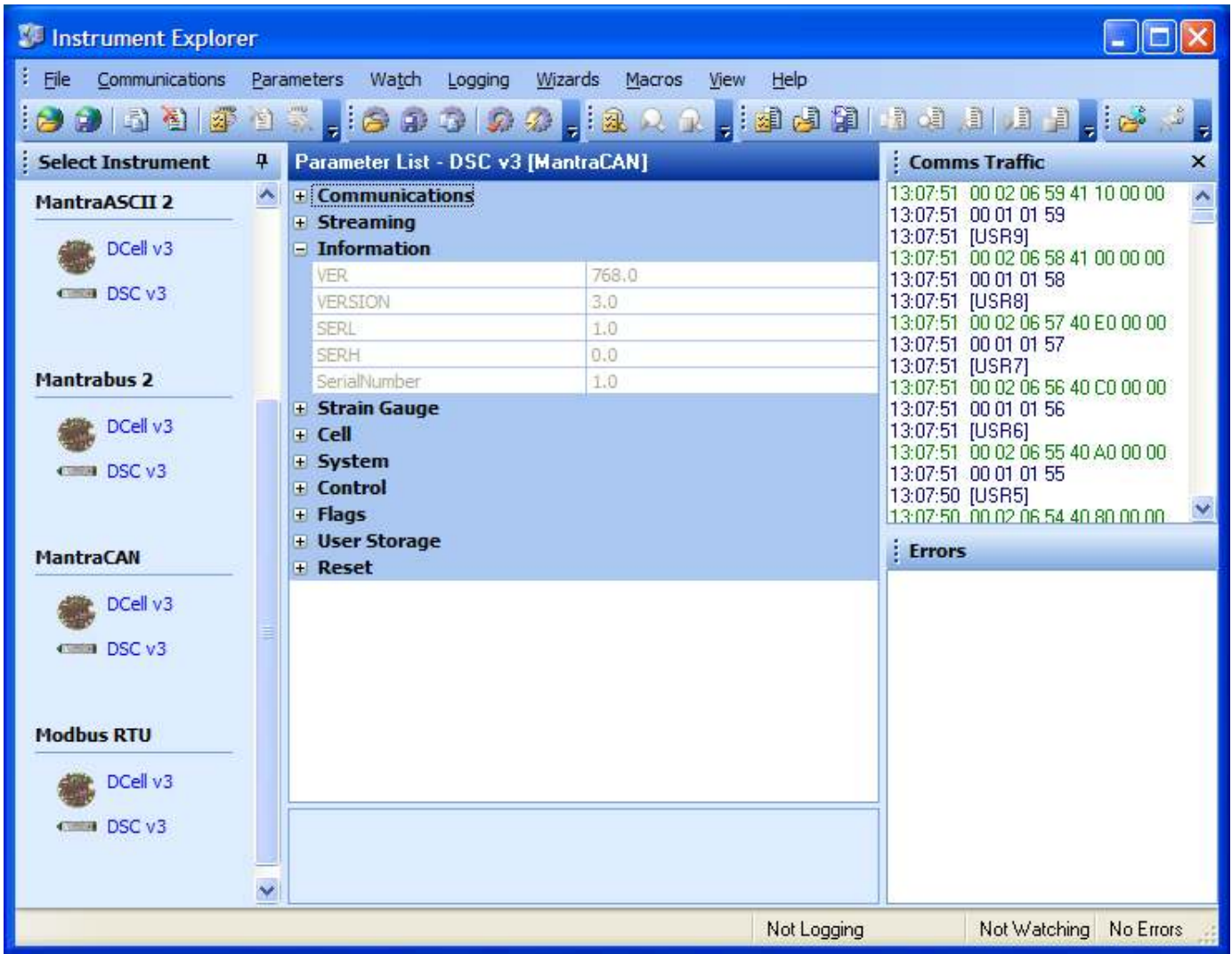

When an instrument has been selected from the **Select Instrument** Window this **Parameter List** window will become populated.

The parameters and commands which are available for the selected device will appear in this list in a structured hierarchic manner enabling the user to expand or contract categories by clicking the **+** and **-** buttons on the left of the list.

There are four types of parameters and commands:

Read/write Numeric - These parameter values are displayed in the right hand column and can be edited by clicking the value.

The value can then be changed and pressing the Enter key or moving away from the edited value will cause the new value to be written to the device. There are no checks on the data entered and it is up to the user to enter the correct data.

NMVV 234.5

NMVV 0.0

Read-Only - These parameter values are displayed 'greyed out' and cannot be changed.

SerialNumber 0.0

Read/write Enumerated - These parameters can only be changed by selecting the new value from a drop down list. Clicking in the right hand column will display a down arrow button which when clicked will display the parameter value options in a list. Note that all enumerated data (apart from on/off) will be displayed with a numeric value, hyphen then the description of the value. The numeric value is the value of the parameter and the description is just there to help.

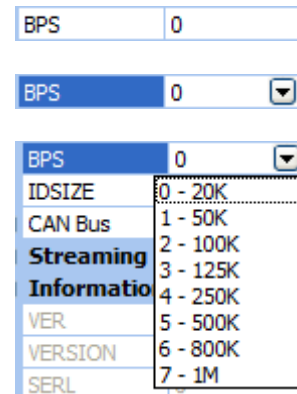

Commands - These commands have 'Click to execute...' displayed in the right hand column. Clicking here will display a button. Click this to issue the command to the device.



As parameters are changed the communications traffic is displayed in the Traffic Pane. If any errors occur these will be shown in red in the Error Pane. Once an error occurs it will need to be reset before any more communications can take place. Reset errors by either right-clicking the Error Pane and selecting **Reset Errors** from the pop-up menu or select the **Communications** menu and click the **Reset Errors** item.

To manually refresh the parameter list click the  button on the toolbar or select **Sync Now** from the **Parameters** menu.

Now you have successfully established communications with your evaluation device the next step is to perform a simple calibration.

Connecting a Load Cell

You can now connect a strain gauge bridge, load cell or simulator to the DCell/DSC.

A suitable strain gauge should have an impedance of 350-5000ohms and (at least for now) a nominal output of around 2.5mV/V.

DSJ1 Evaluation Board Sensor Connections

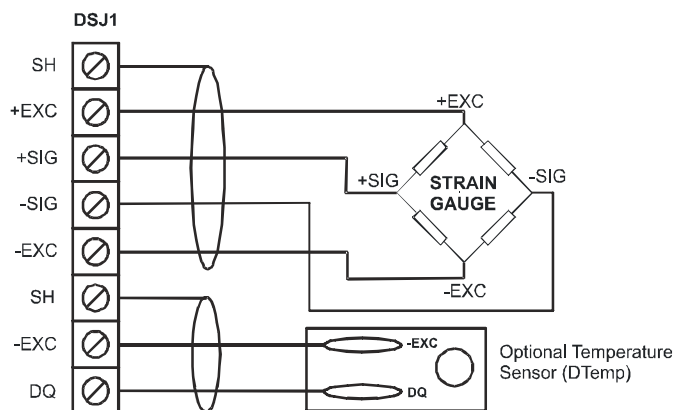

See Chapter 10 for Connection Method to Strain Gauge
See Chapter 5 for Connections to Temperature Sensor Module

Next Instrument Explorer will set to automatically update dynamic parameters from the device so that we can see values as SYS changing on the screen. To do this either click the  button on the toolbar or click on the **Parameters** menu and select the **Auto Sync** item. Note that these options toggle so be sure to leave your selection in the active state.



From the Parameter List click the  next to the **System** heading to expand this level. The Parameter List should look as follows:

System	
Scaling	
Limits	
SRAW	-2.000592
SZ	0.0
SYS	-2.000592
SOUT	-2.000592
SNAP	Click to execute...
SYSN	0.0
Peak + Trough	

This now exposes more levels that can be expanded as required by clicking the  next to the heading name.

System	
Scaling	
SGAI	1.0
SOFS	0.0
Limits	
SMIN	-100.0
SMAX	100.0
SRAW	-2.000592
SZ	0.0
SYS	-2.000592
SOUT	-2.000592
SNAP	Click to execute...
SYSN	0.0
Peak + Trough	
PEAK	-2.000592
TROF	-2.000719
RSPT	Click to execute...

Dynamic values (such as SYS and SRAW) will now be updating in real-time from the device.

Once you have connected the load cell, you should see 'believable' output values, in the "SYS" parameter displayed in the parameter list pane. These values should correspond to mV/V assuming the device is in it's factory default state.

For diagnostics the device has two sets of flags. One being latched and held within the devices non volatile memory (FLAG parameter), the other being dynamic and volatile (STAT parameter).

[-] Flags	
[+] Latched	
[+] Dynamic	

Instrument Explorer provides a simple method of displaying and resetting of individual flags although these are held within the device in FLAG and STAT parameters.

[-] Flags	
[-] Latched	
FLAG	0.0
TEMPUR	Off
TEMPOR	Off
ECOMUR	Off
ECOMOR	Off
CRAWUR	Off
CRAWOR	Off
SYSUR	Off
SYSOR	Off
SGINTEG	Off
WDRST	Off
REBOOT	Off
[+] Reset	
[-] Dynamic	
STAT	0.0
DOUTPUT	Off
DINPUT	Off
DTEMPUR	Off
DTEMPOR	Off

To quickly clear all the flags simply write zero to the FLAG parameter. Now if no problems exist all flags should in their off state.

If any flags remain on then refer to Chapter 3 for flag definitions.

Performing A System Calibration

The values obtained so far are in mV/V units, these are factory calibrated and fixed to within about 0.1% accuracy.

The device also contains two separate user-adjustable calibration parameter groups, these are termed **Cell** and **System**. Cell being used to convert from mV/V to a force and System to convert this force to required engineering units. We shall be using System for the following exercise where we rescale the output value to read in units of your choice, and to calibrate precisely to your load cell / system hardware.

Instrument Explorer provide 'Wizards' to allow quick and simple calibration operations to be undertaken without the use of a calculator. Wizards can be activated by simply selecting the required item from the Wizard menu. Since we are now calibrating at system level we have a choice of two calibration methods:

Sys Calibration Table - This technique is used when a manufacturers calibration document is available for the connected strain gauge. This normally gives mV/V to engineering unit values.

Sys Calibration Auto - This technique is used when the input can be stimulated with real input values. For example you have access to test weight / forces.

We will now describe each of these techniques with an example.

Sys Calibration Table

A 10 tonne load cell manufacturer gives the following data:

mV/V output	Force
2.19053	10 tonne
-0.01573	0 tonne

Start the wizard by selecting **Sys Calibration Table** from the **Wizard** menu

★ SYS Calibration Table

Instructions
This Wizard will allow you to calibrate your instrument by entering input values and required values which can be based on manufacturers tables.

You will need to know two CELL levels and the required SYS values at these points.

The two levels of input should be around 25% or below of full scale for the lower value and a high level at around 75% or higher of full scale.

Press NEXT to continue with the calibration.

Step 1 of 4

Back Next Cancel

Click the **Next** button and enter the low values as shown below

★ SYS Calibration Table

Enter Low Data
Enter the low level input value and required output value.

Enter value for CELL at this low input level. Enter required value for SYS.

-0.01573

Step 2 of 4

Back Next Cancel

Click the **Next** button and enter the high values as shown below

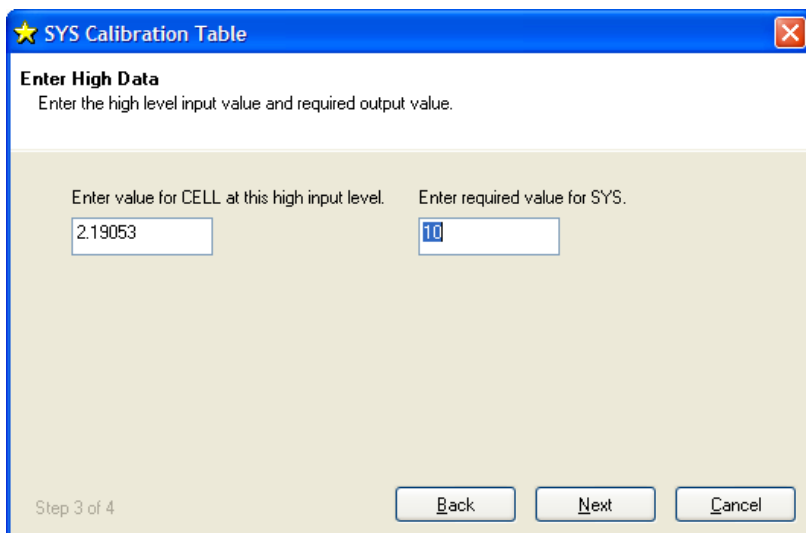

Click **Next** the following window will be displayed showing the calibrated SYS value which is dependent on the current input values

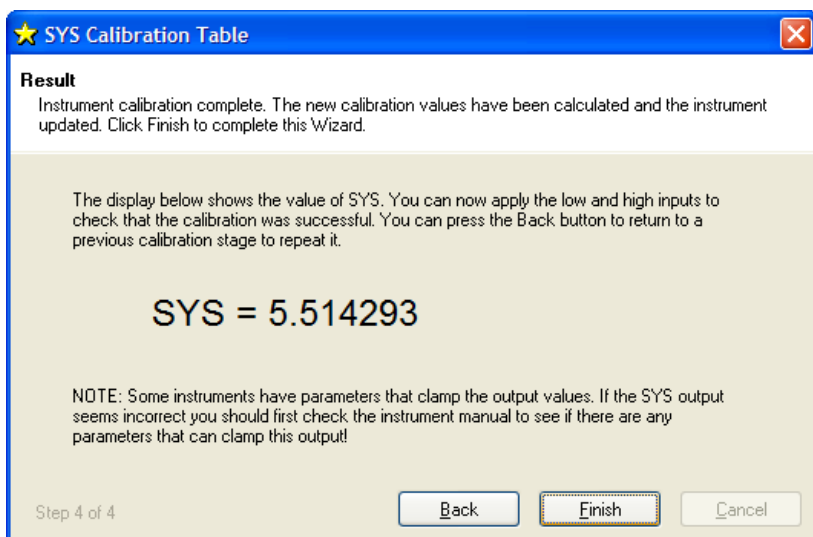

The device is now calibrated. However you may find SYS has been ‘clamped’ if the resultant SYS is greater than SMAX or less than SMIN. If this is the case then change these values to suitable limits. In this example we may set SMIN to -0.5 (tonne) and SMAX to 12.0 (tonne). This would then provide clamping of SYS to these values and also a flags being set in FLAG and STAT.

Sys Calibration Auto

Assume we require to calibrate for Kg output and we have available a known accurate 10 Kg and 100 Kg test weights.

Start the wizard by selecting **Sys Calibration Auto** from the **Wizard** menu

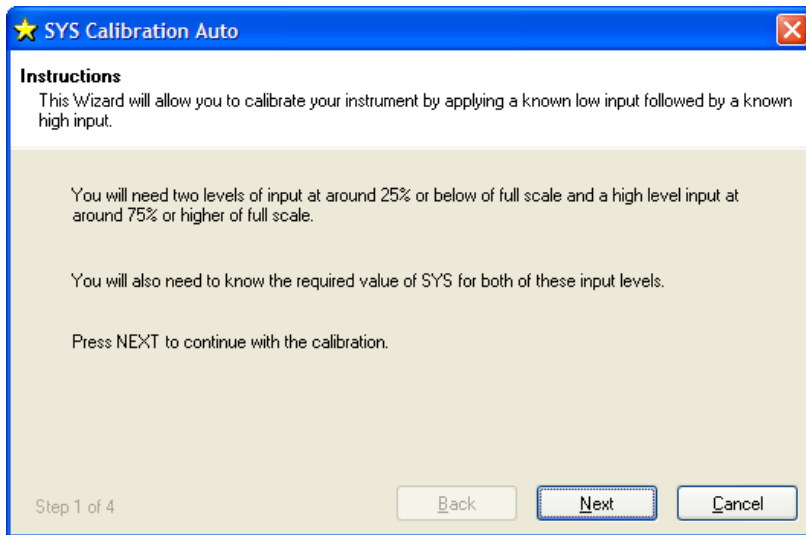

Click Next

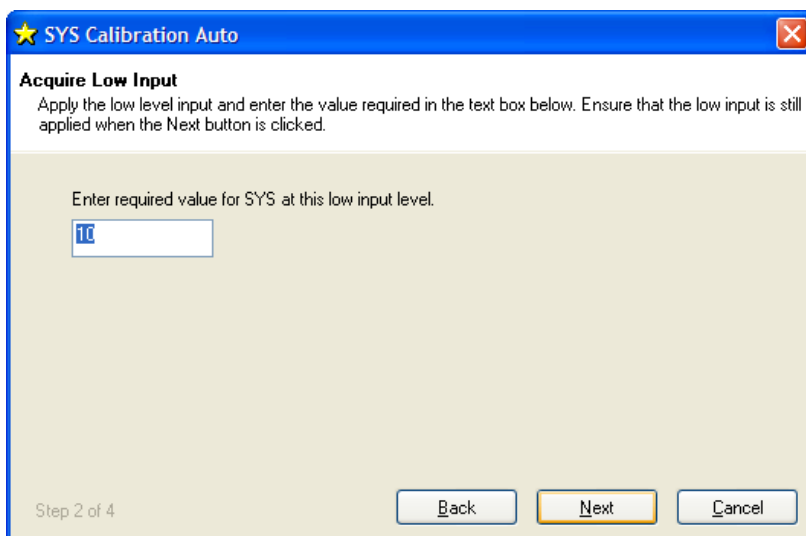

Apply the low known test weight and enter the required SYS value for this weight. In this case it will be 10 as we want the units of SYS to be Kg. Click **Next** to continue

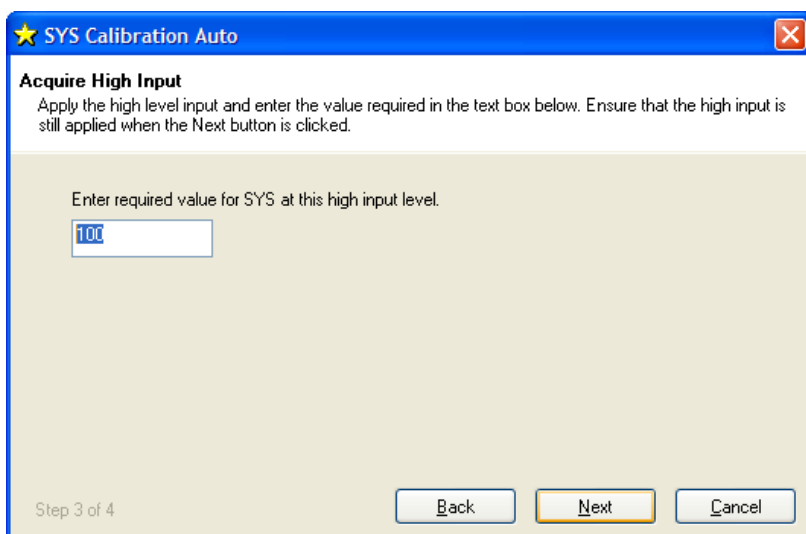

Apply the high known test weight and enter the required SYS value for this weight. In this case it will be 100. Click **Next** to continue

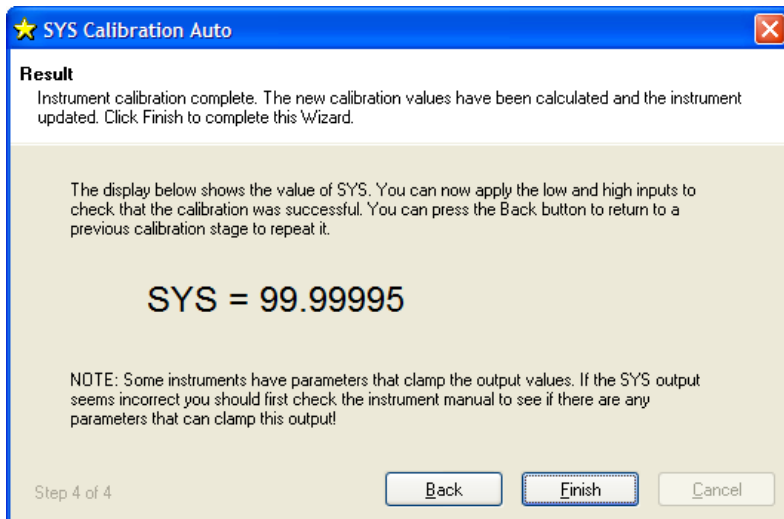

The device is now calibrated. However you may find SYS has been ‘clamped’ if the resultant SYS is greater than SMAX or less than SMIN. If this is the case then change these values to suitable limits. In this example we may set SMIN to -0.5 (Kg) and SMAX to 110.0 (Kg). This would then provide clamping of SYS to these values and also a flags being set in FLAG and STAT.

For detailed information about calibration calculations please refer to chapter 3.

Chapter 3 Explanation of Category Items

Instrument Explorer shows the categories to which parameters and generated variables belong. This provides a convenient method for describing the functionality and purpose of each. The categories can be seen from Instrument Explorers Parameter List pane and are as follows.

Communications

This category deals with the setting of the CAN ID, the bit rate and the ID size. Care must be taken when changing any of these parameters otherwise communications can be lost.

Defaults are:

ID = 1

Identifier length = 11Bits (standard)

Bit Rate = 500Kbps

ID, NODEIDL, NODEIDH

Each device has a single base ID to enable configuration and is factory set to 1, this base ID can be changed. All data sent to the device will be sent to this ID. All data returned from the device will be on the base ID + 1.

Because the device ID is set via CAN, the device should be the only device connected to the CAN bus while configuring from factory settings.

Where the DSC parameters are used to define CAN identifiers the following format is used. The packet identifier is set using a HI and LO parameter. Each of these parameters represents 2 bytes (1 X 16 bit word) that are used to create the identifier.

MSByte	Byte	Byte	LSByte
HI		LO	

Although 16 bits are available to be set using these two parameters the value entered will depend on whether the DSC is set for 11 bit or 29 bit identifiers.

11 bit allows a range of 0 to 3FF

HI is never used on 11 bit so LO would be set to a value from 0 to 3FF

29 bit allows a range of 0 to 1FFFFFFF

HI can range from 0 to 1FFF and LO can range from 0 to FFFF

Example

If the identifier 1ABCDEFF is to be specified:

	MSByte	Byte	Byte	LSByte
	1A	BC	DE	FF
Hexadecimal value	NODEIDH = 0x1ABC		NODEIDL = 0xDEFF	
Decimal value	NODEIDH = 6844		NODEIDL = 57087	

The above values are sent in the floating point IEEE standard

If the identifier 1ABCD is to be specified:

	MSByte	Byte	Byte	LSByte
	00	01	AB	CD
Hexadecimal value	NODEIDH = 0x1		NODEIDL = 0xABCD	
Decimal value	NODEIDH = 1		NODEIDL = 43981	

The above values are sent in the floating point IEEE standard

To connect *multiple* devices on the same bus, it is first vital to set all the ID's to different values. This is because if two devices with the same ID are connected to the same bus, it is not possible to talk to them individually: So in particular, you cannot correct the problem by changing the ID of one of them! If a bus connects to two devices with the same ID, the only solution is to remove one of them and connect it to a one-to-one link to change its station number.

The new value of NODEIDL or NODEIDH does not take effect until the RST command is issued or the device is power cycled.

To Change the ID of your Device

1. First set **NODEIDL and NODEIDH** to a suitable new value (making sure that no other device of the same number is also connected!)
2. Send a **RST** command or power cycle the device.
3. Change the device settings in Instrument Explorer by selecting **Change Settings** from the **Communications** menu.

CAN Bit Rate, BPS

The **BPS** parameter is a read/write byte value specifying a standard communications bit rate according to the following table -

BPS value	0	1	2	3	4	5	6	7
Bit rate (bps)	20K	50K	100K	125K	250K	500K	800K	1M

Warning: When changing this setting it is possible to lose communication with the device. As well as keeping track of the correct bit rate, it is also essential in this case to be sure that your hardware supports the rate you are changing to.
 The evaluation kit supports all possible DCell/DSC baud rate settings UPTO 1Mbps

The new value of **BPS** does not take effect until the **RST** command is issued or the device is power cycled.

To Change The **BPS**, follow a similar sequence to changing the **STN** value

1. First set **BPS** to the new value
2. Send a **RST** command or power cycle the device.
3. Change the device settings in Instrument Explorer by selecting **Change Settings** from the **Communications** menu. Select new bit rate.

Identifier Size, IDSIZE

Determines if the identifier is 11bit, standard, or 29bit extended. A 0 in **IDSIZE** selects 11bit (standard) and a 1 selects 29bit (extended).

CAN Bus, CANTXERR, CANRXERR, CANSTATUS

These parameters provide diagnostic data for the CAN bus.

CANTXERR

This is the Transmission Error Count as defined in the BOSCH CAN2.0 specification; it is a read only parameter.

CANRXERR

This is the Receive Error Count as defined in the BOSCH CAN2.0 specification; it is a read only parameter.

CANSTATUS

This read only parameter indicates current CAN bus error status. These are derived directly from the CAN controller peripheral.

Bit number	Name	Description
0	AERG	Node detection, dominant bit in the acknowledge slot
1	FERG	Form Error. Violation of one of the fixed bit fields, CRC delimiter, Acknowledgement delimiter or End of Frame
2	CERG	CRC Error
3	SERG	Bit Stuff Error
4	OVRBUF	Buffer Over Run Error
5	OVRTIM	CAN Timer Overrun
6	ERRP	Device is in Error Passive mode
7	BUSOFF	Device is in Bus Off mode

Streaming

The Device supports customisable output streams that can be configured to suit most CAN protocols but do not support any interaction, commands (such as Tare) or parameter writing in anything but the proprietary Mantracourt protocol.

Customisable start and stop messages allow the instrument streaming to be controlled via the host CAN network.

Configuring Output Message Streams

The DSC allows up to 4 custom messages to be streamed. These are user configurable and can contain data from internal parameters. The messages can be streamed at intervals or when the internal parameter value changes or both.

The highly configurable nature of the messages allows the DSC to stream custom data messages on a variety of CAN based networks.

NOTE: Only the proprietary MantraCAN protocol can be used to write to the device or request data.

Message Streams

These are programmed via standard parameters. In the following table the parameters for Message1 are shown. For the other three message parameters substitute the '1' for '2', '3' or '4'.

Streaming Types, STRMTYPE

Sets the type of message stream:

0 - MantraCAN control by issuing STRMON and STRMOFF commands.

1 - Automatic. Streaming starts on power up.

2 - Custom. Streaming is controlled by the user defined Start and Stop packets. (See later)

Starting and stopping Streaming, STRMON, STRMOFF

STRMON Starts streaming messages when STRMTYPE is set to 0 (MantraCAN)

STRMOFF Stops streaming messages when STRMTYPE is set to 0 (MantraCAN)

Message Configuration

Parameter	Function
MSG1EN	Whether this message is enabled. 0 - Disabled 1 - Enabled
MSG1IDL	The low word value of the message identifier. This will contain the decimal value of the lower word (2 bytes) of the ID.
MSG1IDH	The high word value of the message identifier. This will contain the decimal value of the higher word (2 bytes) of the ID. Not necessary if the DSC is set for 11 bit identifiers (CAN 2.0a)
MSG1PL	Message packet length. This value sets the number of data bytes contained in the message. 0 to 8
MSG1B1	Set the byte value of byte 1 in the message. 0 to 255
MSG1B2	Set the byte value of byte 2 in the message. 0 to 255
MSG1B3	Set the byte value of byte 3 in the message. 0 to 255
MSG1B4	Set the byte value of byte 4 in the message. 0 to 255
MSG1B5	Set the byte value of byte 5 in the message. 0 to 255
MSG1B6	Set the byte value of byte 6 in the message. 0 to 255
MSG1B7	Set the byte value of byte 7 in the message. 0 to 255
MSG1B8	Set the byte value of byte 8 in the message. 0 to 255
MSG1SRC	Set the index of the parameter whose data is to be inserted into the outgoing packet. This data will be formatted and placed at the specified position in the message.

MSG1FM	Set the format of the data. See Data types later in this chapter. 0 - Float 1 - Byte Unsigned 2 - Byte 2s Compliment 3 - Byte Sign Bit 4 - Integer Unsigned 5 - Integer 2s Compliment 6 - Integer Sign Bit 7 - Long Unsigned 8 - Long 2s Compliment 9 - Long Sign Bit
MSG1SFM	Set the sub format of the data. 0 - None 1 - Reverse Bytes 2 - Reverse Words 3 - Reverse Bytes and Words
MSG1SP	Sets the start position of the data within the message. 1 to 8
MSG1GAI	The gain to apply to the data value.
MSG1OFS	The offset to apply to the data value.
MSG1INT	The interval that the message shall be sent at in milliseconds . Maybe modified by the MSG1TRG parameter. 100 to 60000
MSG1TRG	Sets how the message is triggered. 0 - At Interval 1 - At Interval And On Change 2 - On Change Only

Custom Start / Stop

When STRMTYPE is set to 2 (Custom) the streaming is controlled by external packets arriving that match the user defined message defined by the following Start and Stop message matching parameters. The identifier and the data can be specified and a matching received message will then start or stop the streaming.

Although all eight data bytes are available to define these messages, the incoming message is only tested against the stored bytes up to its own length. I.e. if the incoming message contained only two data bytes then these will be compared to SONB1 and SONB2 and if they match then the streaming will start.

This technique can be used to let the DSC conform to any CAN based start and stop message. I.e. support NMT messages in CANopen®.

Start Streaming

Parameter	Function
SONIDL	The low word value of the message identifier to start the streaming. This will contain the decimal value of the lower word (2 bytes) of the ID.

SONIDH	The high word value of the message identifier to start the streaming. This will contain the decimal value of the higher word (2 bytes) of the ID. Not necessary if the DSC is set for 11 bit identifiers (CAN 2.0a)
SONB1	The decimal value of data byte 1 that the incoming message must match to start streaming.
SONB2	The decimal value of data byte 2 that the incoming message must match to start streaming.
SONB3	The decimal value of data byte 3 that the incoming message must match to start streaming.
SONB4	The decimal value of data byte 4 that the incoming message must match to start streaming.
SONB5	The decimal value of data byte 5 that the incoming message must match to start streaming.
SONB6	The decimal value of data byte 6 that the incoming message must match to start streaming.
SONB7	The decimal value of data byte 7 that the incoming message must match to start streaming.
SONB8	The decimal value of data byte 8 that the incoming message must match to start streaming.

Stop Streaming

Parameter	Function
SOFFIDL	The low word value of the message identifier to stop the streaming. This will contain the decimal value of the lower word (2 bytes) of the ID.
SOFFIDH	The high word value of the message identifier to stop the streaming. This will contain the decimal value of the higher word (2 bytes) of the ID. Not necessary if the DSC is set for 11 bit identifiers (CAN 2.0a)
SOFFB1	The decimal value of data byte 1 that the incoming message must match to stop streaming.
SOFFB2	The decimal value of data byte 2 that the incoming message must match to stop streaming.
SOFFB3	The decimal value of data byte 3 that the incoming message must match to stop streaming.
SOFFB4	The decimal value of data byte 4 that the incoming message must match to stop streaming.
SOFFB5	The decimal value of data byte 5 that the incoming message must match to stop streaming.

SOFFB6	The decimal value of data byte 6 that the incoming message must match to stop streaming.
SOFFB7	The decimal value of data byte 7 that the incoming message must match to stop streaming.
SOFFB8	The decimal value of data byte 8 that the incoming message must match to stop streaming.

Data Types

The MSG1FM and MSG1SFM parameters can define how data is to be represented in the outgoing message packets.

MSG1FM

Format	Value Range	Representation	Notes				
0 - Float	-1.17594e-38 to 3.402823e+38	<table border="1" style="display: inline-table;"><tr><td>MSB</td><td></td><td></td><td>LSB</td></tr></table>	MSB			LSB	Formatted to IEEE 854 standard MSB first
MSB			LSB				
1 - Byte Unsigned	0 to 255	<table border="1" style="display: inline-table;"><tr><td>MSB</td></tr></table>	MSB				
MSB							
2 - Byte 2s Compliment	-128 to 127	<table border="1" style="display: inline-table;"><tr><td>MSB</td></tr></table>	MSB				
MSB							
3 - Byte Sign Bit	-127 to 127	<table border="1" style="display: inline-table;"><tr><td>MSB</td></tr></table>	MSB	The most significant bit indicates a negative number when set to 1.			
MSB							
4 - Integer Unsigned	0 to 65535	<table border="1" style="display: inline-table;"><tr><td>MSB</td><td>LSB</td></tr></table>	MSB	LSB			
MSB	LSB						
5 - Integer 2s Compliment	-32768 to 32767	<table border="1" style="display: inline-table;"><tr><td>MSB</td><td>LSB</td></tr></table>	MSB	LSB			
MSB	LSB						
6 - Integer Sign Bit	-32767 to 32767	<table border="1" style="display: inline-table;"><tr><td>MSB</td><td>LSB</td></tr></table>	MSB	LSB	The most significant bit indicates a negative number when set to 1.		
MSB	LSB						
7 - Long Unsigned	0 to 9999999	<table border="1" style="display: inline-table;"><tr><td>MSB</td><td></td><td></td><td>LSB</td></tr></table>	MSB			LSB	
MSB			LSB				
8 - Long 2s Compliment	-9999999 to 9999999	<table border="1" style="display: inline-table;"><tr><td>MSB</td><td></td><td></td><td>LSB</td></tr></table>	MSB			LSB	
MSB			LSB				
9 - Long Sign Bit	-9999999 to 9999999	<table border="1" style="display: inline-table;"><tr><td>MSB</td><td></td><td></td><td>LSB</td></tr></table>	MSB			LSB	The most significant bit indicates a negative number when set to 1.
MSB			LSB				

Sub Formats

The sub format allows manipulation of the byte order to match the required format.

MSG1SFM

The following table shows how the bytes will be arranged after subformat conversion. This assumes an original order of

1	2	3	4
---	---	---	---

This does not affect the Byte format type.

SubFormat	Integer	Long & Float
-----------	---------	--------------

0 - None	<table border="1"><tr><td>1</td><td>2</td></tr></table>	1	2	<table border="1"><tr><td>1</td><td>2</td><td>3</td><td>4</td></tr></table>	1	2	3	4
1	2							
1	2	3	4					
1 - Reverse Bytes	<table border="1"><tr><td>2</td><td>1</td></tr></table>	2	1	<table border="1"><tr><td>4</td><td>3</td><td>2</td><td>1</td></tr></table>	4	3	2	1
2	1							
4	3	2	1					
2 - Reverse Words	<table border="1"><tr><td>1</td><td>2</td></tr></table>	1	2	<table border="1"><tr><td>3</td><td>4</td><td>1</td><td>2</td></tr></table>	3	4	1	2
1	2							
3	4	1	2					
3 - Reverse Bytes & Words	<table border="1"><tr><td>2</td><td>1</td></tr></table>	2	1	<table border="1"><tr><td>2</td><td>1</td><td>4</td><td>3</td></tr></table>	2	1	4	3
2	1							
2	1	4	3					

Message Output Examples

Streaming Start / Stop Examples

The following example shows how to start and stop streaming by looking for the CANopen® NMT commands. The NMT command for broadcast Start Node is:

ID = 00
 Data Byte 1 = 01
 Data Byte 2 = 00

To configure the DSC to start streaming on receiving this command:

STRMTYPE = 2
 SONIDL = 0
 SONIDH = 0
 SONB1 = 1
 SONB2 = 0

The NMT command for broadcast Stop Node is:

ID = 00
 Data Byte 1 = 02
 Data Byte 2 = 00

To configure the DSC to stop streaming on receiving this command:

STRMTYPE = 2
 SONIDL = 0
 SONIDH = 0
 SONB1 = 2
 SONB2 = 0

Information

Reports the current version of the devices software and the devices unique serial number. Note that VERSION is the read able item derived from the devices internal value of VER and SerialNumber is derived from SERL and SERH.

Software Version, VER

The VER parameter (read-only byte) returns a value identifying the software release number, coded as $256 \times (\text{major-release}) + (\text{minor-release})$, where MSB of VER is major release and LSB of VER is minor release

Eg. current version 3.1 returns VER=769 ($256 \times 3 + 1$)

Serial Number, SERL and SERH

SERL and SERH are read-only integer parameters returning the device serial-number. This is decoded as $= 65536 \times \text{SERH} + \text{SERL}$.

Strain Gauge

This is where the measurement process starts. If the optional temperature module is fitted then **TEMP** will display actual temperature in Degree C. Otherwise **TEMP** will display 125 Degree C.
RATE is the parameter that selects measurement cycle update rate.

mV/V output, MVV

MVV is the factory calibrated mV/V output and it is this value that all other measurement output values are derived from. Factory calibration is within 0.05%.

Nominal mV/V level, NMVV

This is used to represent the nominal mV/V value representing 100% of full scale. This value is used solely for the generation of **ELEC**. It is factory set for 2.5mV/V. If the electronic gain is adjusted by changing the gain resistor then if **ELEC** is used **NMVV** value must be changed to represent the new nominal mV/V.

mV/V Output In Percentage Terms, ELEC

This is mainly for backwards compatibility with Version 2. It is the mV/V value represented in percentage terms, 100% being the value set by **NMVV**.

Temperature Value, TEMP

If the optional temperature module is fitted, **DTEMP** then **TEMP** will display actual temperature in Degree C. Otherwise **TEMP** will display 125 Degree C. **TEMP** is used by the temperature compensation. See chapter 5

Output Rate Control, RATE

The **RATE** parameter is used to select the output update rate, according to the following table of values -

RATE value	0	1	2	3	4	5	6	7	8
update rate (readings per second)	1	2	5	10	20	50	60	100	200

The default rate is 10Hz (**RATE**=3): The other settings give a different speed/accuracy trade-off. Invalid **RATE** values are treated as if it was set to 3.

The underlying analogue to digital conversion rate is 1627Khz. These results are block averaged to produce the required output rate.

To Change The Output Rate

1. Set **RATE** to the new value
2. Click on the 'RST' button to reboot the device
3. Wait for one second for the reset procedure to complete and measure cycle to start

With **RATE** set to 0, you should be able to see the **SYS** update rate slow to once a second, and the noise level should also noticeably decrease.

All the main-reading output values are updated at this rate. Rate does not change the rate at which temperature output **TEMP** is updated.

Important Note:

For A **RATE** of 8 (200Hz) Temperature compensation and Linearisation cannot be used due to Calculation time required.

Dynamic Filtering, FFST and FFLV

The Dynamic filter is basically a recursive filter and therefore behaves like an "RC" circuit. It has two user settings, a level set in mV/V by **FFLV** and a maximum number of steps set by **FFST**, maximum value **FFST** can be is 255. If a difference between a new input value (**RMVV**) and the current filtered value (**MVV**) is greater than **FFLV** then the fractional amount of the new reading added to the current reading is reset to 1, that is to say that output of the

filter will be equal to the new input reading. If the difference is less than **FFLV** then the fractional amount added is incremented until it reaches the maximum level set by **FFST**. IE if **FFST** = 10 then after a step change the fractional part of a new reading is incremented as follows

1/1, 1/2, 1/3, 1/4, 1/5, 1/6.... 1/10, 1/10, 1/10

This allows the Filter to respond rapidly to a fast moving input signal.

With a step change, which does not exceed **FFLV**, the calculated new filtered value can be calculated as follows

$$\text{New Filter Output value} = \text{Current Filter Output Value} + ((\text{Input Value} - \text{Current Filter Output Value}) / \text{FFST})$$

The time taken to reach 63% of a step change input (which is less than **FFLV**) is the frequency at which values are passed to the dynamic filter, set in **RATE**, multiplied by **FFST**.

The table below gives an indication of the response to a step input less than **FFLV**. Update Rate is 1/table value of **RATE** see Chapter 3 Output Rate Control.

% Of Final Value	Time To settle
63%	Update Rate * FFST
1%	Update Rate * FFST * 5
0.1%	Update Rate * FFST * 7

For example, If **RATE** is set to 7 = 100Hz = 0.01s and **FFST** is set to 30 then the time taken to reach a % of step change value is as follows.

% Of Final Value	Time To settle
63%	0.01 x 30 = 0.3 seconds
1%	0.01 x 30 x 5 = 1.5 seconds
0.1%	0.01 x 30 x 7 = 2.1 seconds

The following table shows the number of updates x **FFST** and the error % **New Filter Output value** will differ from a constant **Input Value**.

x FFST	% Error
1	36.78794412
2	13.53352832
3	4.97870684
4	1.83156389
5	0.67379470
6	0.24787522
7	0.09118820
8	0.03354626
9	0.01234098
10	0.00453999
11	0.00167017
12	0.00061442
13	0.00022603
14	0.00008315
15	0.00003059
16	0.00001125
17	0.00000414
18	0.00000152
19	0.00000056
20	0.00000021

Remember that if the step change in mV/V is greater than the value set in **FFLV** then

New Filter Output value = New Input Value.

And the internal working value of FFST is reset to 1, being incremented each update set by RATE until it reaches the user set value of FFST.

Cell

Provides the level where the integration between the DCell/DSC and the strain gauge bridge takes place. Features include, when the optional temperature module is fitted, 5-point temperature compensation to produce a temperature compensated value **CMVV**. Scaling using a gain and offset, **CGAI** and **COFS** respectively, producing a value known as **CRAW**. Linearisation, using up to 7-points, producing the final output from this section known as **CELL**. Over load and under load values can be set in **CMIN** & **CMAX** to alert the user of forces less or greater than the integrator has intended the unit to be operated. These features allow the output **CELL** to be in force units which can be used by 'System' to convert to units of weight.

Temperature compensation and linearisation are covered in detail in their own chapters.

Temperature Compensation In Brief

When the optional temperature hardware module DTEMP is connected the temperature compensation is available. The temperature compensation facility can remove the need for the fitting of compensation resistors to the strain gauges. This compensation can apply for gain and offset with up to 5 temperature points. The input for the temperature compensation is **MVV** and the output from the process is **CMVV**. If not temperature compensation is invoked the **CMVV** is equal to **MVV**

Temperature compensation cannot be used at RATE of 8 (200Hz)

A Detailed explanation is given in chapter 5

Cell Scaling, CGAI, COFS

The temperature compensated value **CMVV** is scaled with gain and offset using **CGAI** and **COFS** respectively. The gain is applied first and the offset the subtracted. This would be used to give a force output in the chosen units, this output being termed **CRAW**.

$$\text{CRAW} = (\text{CMVV} \times \text{CGAI}) - \text{COFS}$$

Two Point Calibration Calculations and Examples

Examples are given here for two point calibration, as this is by far the most common method.

Cell Calibration

The scaling parameters are **CGAI** and **COFS**

CGAI is in cell-units per mV/V'

COFS is in cell units

The cell output calculation is (in the absence of temperature and linearity corrections) -

$$\text{CRAW} = (\text{CMVV} \times \text{CGAI}) - \text{COFS}$$

If we have two electrical-output (**MVV**) readings for two known force loads, we can convert the output to the required range. So if -

$$\text{test load} = fA \rightarrow \text{CMVV reading} = cA$$

$$\text{test load} = fB \rightarrow \text{CMVV reading} = cB$$

- then calculate the following gain value

$$\text{CGAI} = (fB - fA) / (cB - cA)$$

and the offset is

$$\text{COFS} = (cA \times \text{CGAI}) - fA$$

The outputs should then be **CELL** = fA, fB true force values, as required.

Calibration Methods

There are a number of ways of establishing the correct control values.

Method 1 - Nominal (data sheet) Performance Values

This is the simplest method, where the given nominal mV/V sensor output is used to calculate an approximate value for CGAI.

Example.

A 50 kN load cell has nominal sensitivity of 2.2mV/V full-scale.

So to get 50.0 for an input of 2.2mV/V, we set CGAI to $50/2.2 \approx 22.7273$. This assumes the output for 0kN is 0mV/V.

Method 2 - Device Standard (Calibration) Values

With some load cells you may have a manufacturer's calibration document. This gives precise cell-output gain and offset specifications for the individual cell. These values can be used to set the SGAI and SOFS values to be used.

Example.

A 10 tonne load cell has a calibration sheet specifying 2.19053mV/V full-scale output, and -0.01573mV/V output offset.

CGAI is set to $10 / (2.19053 - -0.01573) \approx 4.532557$.

COFS is set to $-0.01573 \times 4.532557 \approx -0.0071297$

NOTE:

Methods 1 and 2 require no load tests. This means that systematic installation errors cannot be removed, such as cells not being mounted exactly vertical. The accuracy is also limited by the DCell/DSC electrical calibration accuracy, which is about 0.1%.

The remaining methods require testing with known loads, but are therefore inherently more reliable in practice, as they can remove unexpected complicating factors relating to installation.

Method 3 - Two-Point Calibration Method

This is a simple in-system calibration procedure, and probably the commonest method in practice (as in the previous example).

Two known loads are applied to the system, and reading results noted, then calibration parameters are set to provide exactly correct readings for these two conditions.

E.G. a 10kN (1-tonne) load cell has a CELL reading of +0.120721mV/V with no load, and -2.21854mV/V with a known 100Kg test-weight.

To calibrate this to read in a -1.0 to +1.0 tonne range,

Calculate CGAI as $0.1 / (2.21854 - +0.120721) = 0.047669$.

Set COFS= $0.120721 \times 0.047669 = 0.005755$.

Method 4 - Multi-point Calibration Test

For ultimate accuracy to a whole series of point measurements may be taken to determine the best linear scaling of input output: Effectively, a 'best line' through the data is then chosen, and the calibration is set up to follow the line.

Testing of this sort is also used to establish linearity corrections, and similar tests at different temperatures are used to set up temperature compensation (see Chapters on Temperature Compensation *and* Linearity Compensation).

Note: Instrument Explorer provides "wizards" for easy calibration of the Cell stage. There are two wizards, 'Cell Calibration Auto' and 'Cell Calibration Table' these can be found under the menu item "Wizards".

Cell Limits, CMIN, CMAX

These are used to indicate that the desired maximum and minimum value of CRAW have been exceeded. They are set in Force units. On CRAW being greater than the value set in CMAX the CRAWOR flag is set in both FLAG and

STAT, the value of CRAW is also clamped to this value. On CRAW being less than the value set in CMIN the CRAWUR flag is set in both FLAG and STAT, the value of CRAW is also clamped to this value.

Linearisation In Brief

Linearisation allows for any non-linearity in the strain gauge measurement to be removed. Up to 7 points can be set using CLN. The principle of operation is that the table holds a value at which an offset is added. The point in the table that refer to CRAW are named CLX1..CLX7. The offsets added at these point are named CLK1.. CLK7 and are set in thousandths of a cell unit. The output from the Linearisation function is CELL. If no Linearisation is used (CLN < 2) the CELL is equal to CRAW.

Linearisation cannot be used at RATE of 8 (200Hz)

A Detailed explanation is given in chapter 6

System

System is where the “Force” output, CELL, is converted to weight when installed into a system. Other features such as SZ offers a means of zeroing the system output SYS. Peak and Trough values are also recorded against the value of SYS, these are volatile and reset on power up. A command SNAP records the next SYS value and stores in SYSN, this is useful where more than 1 device in a system and to prevent measurement skew across the system the SNAP command can be broadcast to all devices ready for polling of their individual SYSN values.

System Scaling, SGAI, SOFS

The cell output value CELL is scaled with gain and offset using SGAI and SOFS respectively. The gain is applied first and the offset the subtracted. This would be used to give a force output in the chosen units, this output being termed SRAW.

$$\text{SRAW} = (\text{CELL} \times \text{SGAI}) - \text{SOFS}$$

If we have two cell-output (CELL) readings for two known test loads, we can convert the output to the required range. So if -

Test load = xA → CELL reading = cA

Test load = xB → CELL reading = cB

Then we calculate the following gain value

$$\text{SGAI} = (\text{xB} - \text{xA}) / (\text{cB} - \text{cA})$$

And then the offset

$$\text{SOFS} = (\text{cA} \times \text{SGAI}) - \text{xA}$$

The outputs should now be SRAW = xA, xB true load values, as required.

Example of calculations for SGAI and SOFS

Example:

A 2500Kgf load cell installation is to be calibrated by means of test weights.

The cell calibration gives an output in Kgf ranging 0-2000.

A system calibration is required to give an output reading in the range 0-1.0 tonnes.

Calculations

Take readings with two known applied loads, such as -

For test load of xA = 99.88Kg : CELL reading cA = 100.0112

For test load of xB = 500.07Kg: CELL reading cB = 498.7735

Calculate gain value. In this case put $SGAI = (xB - xA) / (cB - cA)$
 $= (0.50007 - 0.09988) / (498.7735 - 100.0112)$
 $\approx 0.001003580 = 1.003580 \times 10^{-3}$

Calculate offset value. In this case $SOFS = (cA \times SGAI) - xA$
 $= (100.0112 \times 1.003580 \times 10^{-3}) - 0.09988$
 ≈ 0.00048924

Check

Putting the values back into the equation, results for the two test loads should then be –

For $x = 99.88\text{Kg}$, $CELL = 100.0112$, so

$$SRAW \approx (100.0112 \times 1.003580 \times 10^{-3}) - 0.00048924 \approx 0.09988$$

For $x = 500.07\text{Kg}$, $CELL = 498.7735$, so

$$SRAW \approx (498.7735 \times 1.003580 \times 10^{-3}) - 0.00048924 \approx 0.5006987$$

The remaining errors are due to rounding the parameters to 7 figures.

Internal parameter storage is only accurate to about 7 figures, so errors of about this size can be expected in practice.

System Limits, SMIN, SMAX

These are used to indicate that the desired maximum and minimum value of **SRAW** have been exceeded. They are set in weight units. On **SRAW** being greater than the value set in **SMAX** the **SRAWOR** flag is set in both **FLAG** and **STAT**, the value of **SRAW** is also clamped to this value. On **SRAW** being less than the value set in **SMIN** the **SRAWUR** flag is set in both **FLAG** and **STAT**, the value of **SRAW** is also clamped to this value.

System Zero, SZ

SZ provides a means of applying a zero to **SYS** and **SOUT**. This could be used to generate an Net value making **SRAW** in effect a gross value.

$$SYS = SRAW - SZ$$

Care should be taken on how often **SZ** is written to, see “WARNING: Finite Non-Volatile Memory Life” later in this chapter.

System Outputs, SYS, SOUT

SYS is considered to be the main output value and it is this value that would be mainly used by the master. **SOUT** is for backwards compatibility with Version 2

Reading Snapshot, SNAP, SYSN

The action command **SNAP** samples the selected output by copying **SYS** to the special result parameter **SYSN**.

The main use of this is where a number of different inputs need to be sampled at the same instant.

Normally, multiple readings are staggered in time because of the need to read back results from separate devices in sequence: MantraCAN can be used to send **SNAP** commands to individual unit but as MantraCAN does not directly support broadcast. A scheme using a user selected identifier and data mask can be configured to allow multiple device to perform their **SNAP** function on a single message.

Because the trigger message is user defined this can be any message the network supports and not necessarily a broadcast type message.

By transmitting a **SNAP** command at the required time, all devices on the bus will sample their inputs within the update rate set by **RATE**. The resulting values can then be read back in the normal way from all the devices **SYSN** parameters.

Note: Instrument Explorer provides “wizards” for easy calibration of the System stage. There are two wizards, ‘Sys Calibration Auto’ and ‘Sys Calibration Table’ these can be found under the menu item “Wizards”.

Control

Shunt Calibration Commands, *SCON* and *SCOF*

The Device is fitted with a “Shunt” calibration resistor whose value is 100K. This can be switched across the bridge, using **SCON**, giving an approximate change of 0.8mV/V at nominal 2.5mV/V. The command **SCOF** removes the resistor from across the bridge. It is important for the user to remember to switch out the shunt calibration resistor after calibration has been confirmed.

Digital Output, *OPON* and *OPOF*

For DSC **ONLY** an open collector output is available. This can be switched on using **OPON** and off by the command **OPOF**. This output is capable of switching 100mA at 30v (TBC)

Flags

Diagnostics Flags, *FLAG* and *STAT*

All the self-diagnostics rely on the **FLAG** & **STAT** parameters, which are 16-bit integer register in which different bits of the value represent different diagnostic warnings. **FLAG** is stored in EEPROM and is therefore non-volatile, **STAT** is stored in RAM and reset on power-up to 0. **FLAG** is latching requiring reset by the user where as **STAT** is non-latching showing current error status.

Latched Warning Flags (*FLAG*)

The flags are normally used as follows:-

FLAG is read at regular intervals by the host (like the main output value, but generally at longer intervals)

If some warnings are active, i.e. **FLAG** is non-zero, then the host tries to cancel the warnings found by writing **FLAG= 0**

The host then notes whether the error then either remains (i.e. couldn't be cancelled), or if it disappears, or if it re-occurs within a short time, and will take action accordingly.

The warning flags are generally latched indicators of transient error events: By resetting the register, the host both signals that it has seen the warning, and readies the system to detect any re-occurrence (i.e. it resets the latch).

What the host should actually do with warnings depends on the type and the application: Sometimes a complete log is kept, sometimes no checking at all is needed.

Often, some warnings can be ignored unless they recur within a short time.

Warning flags survive power-down, i.e. they are backed up in non-volatile (EEPROM) storage.

Though useful, this means that repeatedly cancelling errors which then shortly recur can wear out the device non-volatile storage - see Chapter 3 Basic Set-up and Calibration.

Meaning and Operation of Flags

The various bits in the FLAG value are as follows

Bit	Value	Description	Name
0	1	(unused - reserved)	Unused
1	2	(unused - reserved)	Unused
2	4	Temperature under range (TEMP)	TEMPUR
3	8	Temperature over-range (TEMP)	TEMPOR
4	16	Strain gauge input under-range	ECOMUR
5	32	Strain gauge input over-range	ECOMOR
6	64	Cell under-range (CRAW)	CRAWUR
7	128	Cell over-range (CRAW)	CRAWOR
8	256	System under-range (SRAW)	SYSUR
9	512	System over-range (SRAW)	SYSOR
10	1024	(unused - reserved)	Unused
11	2048	Load Cell Integrity Error (LCINTEG)	LCINTEG
12	4096	Watchdog Reset	WDRST
11	8192	(unused - reserved)	Unused
14	16384	Brown-Out Reset	BRWNOUT
15	32768	Reboot warning (Normal Power up)	REBOOT

NOTE:

The mnemonic names are used by convenience properties in Instrument Explorer, but are otherwise for reference only -the flags can only be accessed via the FLAG parameter.

The various warning flags have the following meanings

TEMPUR and TEMPOR indicate temperature under-and over-range. The temperature minimum and maximum settings are part of the temperature calibration, fixed at -50.0 and +90.0 °C. Only active when optional Temperature module fitted.

ECOMUR and ECOMOR are the basic electrical output range warnings. These are tripped when the electrical reading goes outside fixed $\pm 120\%$ limits: This indicates a possible overload of the input circuitry, i.e. the input is too big to measure.

The tested value, ECOM is an un-filtered precursor of ELEC

CRAWUR and CRAWOR are the cell output range warnings. These are tripped when the cell value goes outside programmable limits CMIN or CMAX.

The tested value, CRAW is the cell output prior to linearity compensation.

SYSUR and SYSOR are the system output range warnings. These are triggered if the SYS value goes outside the SMIN or SMAX limits.

LCINTEG indicates a missing or a problem with the Load cell. It is based on the common mode of the -SIG being correct. NOTE This flag will also be set when the shunt calibration has been switched on.

WDRST indicates that the Watchdog has caused the device to re-boot. If this error continually occurs consult factory.

BRWNOUT indicates that the device has re-booted due to the supply voltage falling below 4.1V, the minimum spec for supply voltage is 5.6V and this must include any troughs in the AC element of this supply.

REBOOT is set whenever the DCell/DSC is powered up and is normal for a power up condition. This flag can be used to warn of power loss to device.

Dynamic Status Flags (STAT)

Status are “live” flags, indicating current status of the device. Some of these flags have the same bit value & description from “FLAG”.

Meaning and Operation of Flags

The various bits in the STAT value are as follows

Bit	Value	Description	Name
0	1	Setpoint output status	SPSTAT
1	2	Digital Input status (DSC ONLY)	IPSTAT
2	4	Temperature under range (TEMP)	TEMPUR
3	8	Temperature over-range (TEMP)	TEMPOR
4	16	Strain gauge input under-range	ECOMUR
5	32	Strain gauge input over-range	ECOMOR
6	64	Cell under-range (CRAW)	CRAWUR
7	128	Cell over-range (CRAW)	CRAWOR
8	256	System under-range (SRAW)	SYSUR
9	512	System over-range (SRAW)	SYSOR
10	1024	(unused - reserved)	Unused
11	2048	Load Cell Integrity Error (LCINTEG)	LCINTEG
12	4096	Shunt Calibration Resistor ON	SCALON
11	8192	Stale output value (previously read)	OLDVAL
14	16384	(unused - reserved)	Unused
15	32768	(unused - reserved)	Unused

SPSTAT indicates the state of the Open collector output, 1 being output on 0 being output off.

IPSTAT indicates the state of the digital input (Only available on DSC model). Bit set indicates input is ‘closed’ to 0v (-V or GND).

SCALON Used to indicate that the Shunt Calibration command, **SCON**, has been issued & therefore the shuntcal resistor is now in circuit with the strain gauge bridge. **SCOF** command resets this bit. Note that when Shunt Calibration is active the “Load Cell Integrity Error” will also be generated.

OLDVAL is set when the device is read via the communications. Thus indicating this value has already been sampled. It is reset when a new result has been made available.

Output Update Tracking

The **OLDVAL** flag can be used for output update tracking

This allows sampling each result exactly once: To achieve this poll the **STAT** value until **OLDVAL** is cleared to indicate a new output is ready, then read **SYS**, this reading will set the **OLDVAL** flag in **STAT**.

This scheme works as long as the communications speed is fast enough to keep up. With faster update rates and slower baud rates, it may not be possible to read out the data fast enough.

User Storage

USR1...USR9

There are nine storage locations **USR1** to **USR9**. These are floating point numbers which can be used for storage of data. This data could be calibration time and date, operator number, customer number etc.

This data is not used in anyway by the DCell or DSC.

Reset

The Reset command, RST

This command is used to reset the device. This command **MUST** be issued if the following parameters are changed before the change will take effect. Alternatively the power maybe cycled.

RATE, NODEIDL, NODEIDH, BPS and all of the Message parameters

The reset action may take up to about a second to take effect, followed by the normal start-up pause of 1 second.

WARNING: Finite Non-Volatile Memory Life

The DCell and DSC use EEPROM-type memory as the storage for non-volatile controls (i.e. all the settings that are retained even when powered down).

The device EEPROM itself is specified for 100,000 write cycles (for any one storage location), although typically this is 1,000,000. Therefore -

When automatic procedures may write to stored control parameters, it is important to make sure this does not happen too frequently.

So you should not, for example, *on a regular basis* adjust an offset calibration parameter to zero the output value. However, it *is* reasonable to use this if the zeroing process is initiated by the operator, and won't normally be used repeatedly.

For the same reason, automatically cancelling warning flags must also be implemented with caution: It is okay as long as you are not getting an error recurring *repeatedly*, and resetting it every few seconds.

Chapter 4 The Readings Process

This chapter gives an account of the reading process *except* for the linearity-and temperature-compensation processes (which have their own chapters later on).

Flow diagram

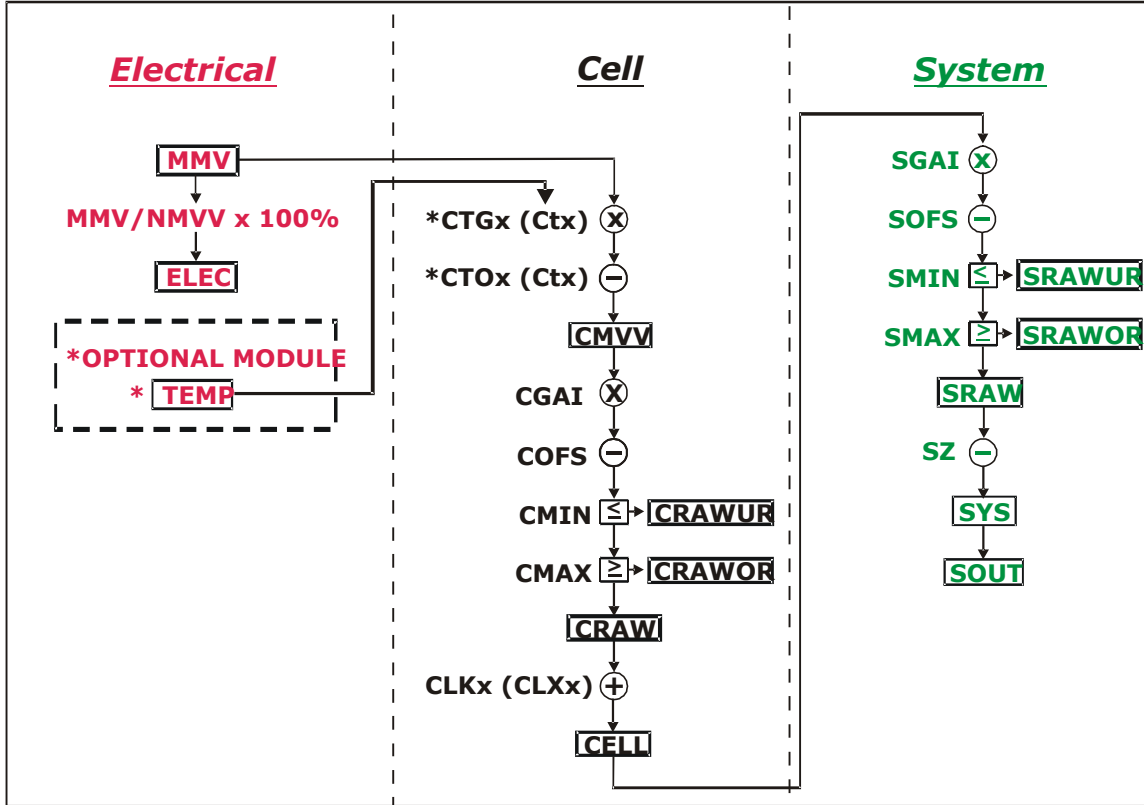

The underlying analogue to digital conversion rate is 3.255Khz. These results are block averaged to produce the required output rate set by the **RATE** control This block averaged result is then passed through the dynamic filter at the same rate and then into the ‘chain’ of above calculations.

The named values shown in the boxes are all output parameters, which can be read back over the comms link. The diagram shows **three separate calibration stages**, called the ‘Electrical’, ‘Cell’ and ‘System’. This allows independent calibrations to be stored for the device itself, the load cell and the installed system characteristics -

Electrical

The ‘Electrical’ calibration produces corrected electrical readings from the internal measurements. This is factory-set by Mantracourt during the production process.

The main outputs from this are -

- **MVV** is the factory calibrated output, in mV/V units.
- **ELEC** is the mV/V in % terms. Where the 100% value is set using **NMMV**. This is for backwards compatibility only.
- **TEMP** is a device temperature measurement, in °C and requires an optional module.

There are also two flags, **ECOMUR** and **ECOMOR** (not shown on the diagram), which indicate an input electrical under- or over-range.

Cell

The 'Cell' calibration converts the mV/V output into a cell-force reading.

This can be used by an OEM sensor manufacturer to provide a standard, calibrated output in force units, which could be based on either typical or device-specific calibration data.

(This stage also includes the temperature- and linearity-corrections, not covered here)

The outputs from this are

- **CMVV** is the temperature compensated mV/V (**MVV**).
- **CRAW** is the scaled temperature compensated value **CMVV**
- **CELL** is a load cell force reading in "Force" units (e.g. kN)
- **CRAWUR** and **CRAWOR** are two flags indicating under or, over range for the force measurement.

System

The 'System' calibration converts the Cell output into a final output value, in the required engineering units.

This is normally be set up by a systems installer or end user, to provide whatever kind of output is needed, independently of device-specific information in the Cell calibration.

(Making this split allows in-service replacement without re calibration).

The Outputs From This Are

- **SRAW** is a re-scaled and offset adjusted output derived from **CELL**
- **SYS** is the final output value, after removing a final user output offset value (**SZ**) from **SRAW**
- **SRAWUR** and **SRAWOR** are output warning limit flags.

In practice, **SRAW** and **SYS** can be used to represent something like gross and net values.

Cell & System Scaling

Both the Cell and System calibrations are simply linear rescaling calculations -i.e. they apply a gain and offset.

In both cases, four parameters define the scaling, offset and min and max limit values. These calculations are applied in the following way:

Output = (Input × **GAI**) - **OFS**

Output = min (output, **MAX**)

Output = max (output, **MIN**)

(In addition, if the value exceeds either limit, one of two dedicated error flags is set)

The control parameters thus have the following characteristics: -

- **GAI** is the multiplying factor, set in "output-units per input-unit"
- **OFS** is the value that gives zero output, set in "output units"
- **MAX** and **MIN** are output limit values, set in "output units"

The units and functions of the main scaling controls can thus be summarised as -

Cell Calibration

CGAI	Force/mV/V	mV/V gain factor
COFS	Force	CELL Offset Value
CMIN	Force	Minimum value for CRAW
CMAX	Force	Maximum value for CRAW

System Calibration

SGAI	Eng/ Force	SYS/CELL gain factor
SOFS	Eng	SRAW value offset
SMIN	Eng	Minimum value for SRAW
SMAX	Eng	Maximum value for SRAW
SZ	Eng	SYS value offset

(MVV is mV/V, "force" is force units, and "eng" is engineering units)

Calibration Parameters Summary and Defaults

The various control parameters are listed for each stage.

This also includes the compensation parameters, not covered in this chapter, but shown in the flow diagram

The 'default' values shown set the device back to its nominal default calibration (mV/V)

Cell Control Defaults

Command	Action	Default Values
FFLV	Filter dynamic level	0.001
FFST	Filter Steps (max)	100
NMMV	Nominal 2.5mV/V	2.5
RATE	Rate 10Hz	3
CGAI	basic cell gain	1.0
COFS	basic cell offset	0.0
CTN	number of temp points	0
CT1..5	temp points (Deg C)	0.0, 0.0, 0,0...
CTO1..5	offset adjusts	0.0, 0.0, 0,0...
CTG1..5	gain adjusts	1.0, 1.0, 1.0, 1.0...
CMIN	CRAW min limit	-3.0
CMAX	CRAW max limit	+3.0
CLN	number of linearity points	0
CLX1..7	linearity raw-value points	0.0, 0.0, 0,0...
CLK1..7	linearity adjusts	0.0, 0.0, 0,0...

System Control Defaults

Command	Action	Default Values
SGAI	basic gain	1.0
SOFS	basic offset	0.0
SMIN	SRAW min limit	-100.0
SMAX	SRAW max limit	+100.0
SZ	output zero offset	0.0

Chapter 5 Temperature Compensation

This chapter explains how to use the Temperature Compensation facilities, to compensate for changes in the measurement with ambient temperature.

Temperature compensation is only provided when an optional module consisting of a digital temperature sensor is wired to the DCell or DSC.

Purpose and Method of Temperature Compensation

Most measurement methods are affected by changes in temperature, and (uncompensated) load cells are especially sensitive, having a large overall temperature coefficient.

Temperature compensation adjusts the measured value in a way that depends on a temperature measurement, so that (ideally) the output does not depend on the current temperature.

In practice, it is usual to refer to a calibration ‘reference’ temperature: The ideal output value is then what the reading ‘would have been’ if made at the reference temperature.

The DCell/DSC temperature compensation facilities make adjustments to the ‘Cell’ calibration parameters (i.e. gain and offset) which depend on temperature, according to a digitally programmed curve.

These adjustments are automatically applied, based on the current device temperature measurement. With some care, this can remove the need for the usual electrical compensation components altogether.

Note that the temperature compensation will also remove the temperature drift of the DCell/DSC itself if the temperature compensation data is collected when the DCell/DSC and strain gauges are tested together as a system.

Temperature Module Connections and Mounting (DTEMP)

The temperature module is connected using only two wires. The temperature sensor is the Dallas “1-Wire” digital device DS18S20. One connection is ground for which -EXC is used and the other is the 1 wire “DQ” connection which provides the bi-directional data line.

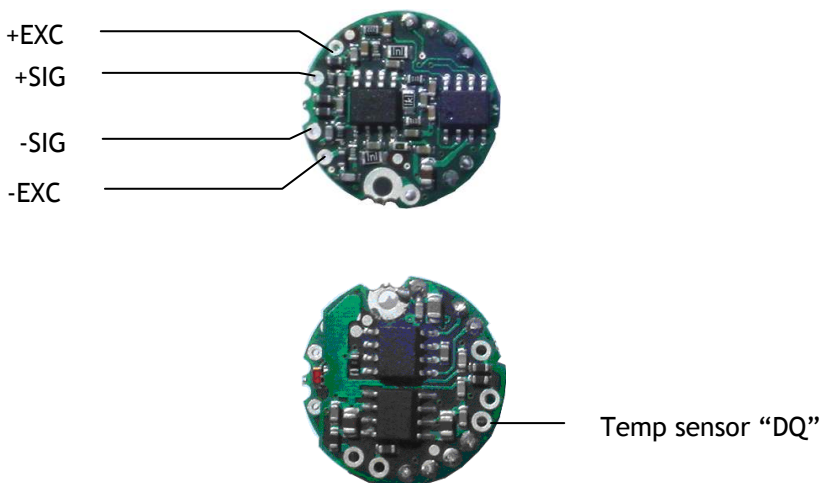

Note: -EXC provides the ground connection to the optional temperature module.

For DSC the DQ connection is connected to the I/O pin marked TS.

The temperature module is a small double sided PCB with an 8 pin SOIC integrated circuit mounted to it. The dimensions are 10.5 x 7.6 x 2.5mm. There are two solder pads for connection to the DSC or DCell. A 2mm hole is used for fixing the temperature module to the body of the load cell. The module should, ideally, be positioned as

close as possible to the strain gauges. The IC on the temperature module must also be in good thermal contact to the load cell body so the strain gauges and temperature sensor see the same temperature.

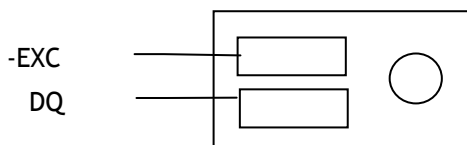

Control Parameters

The temperature compensation parameters define a pair of lookup tables that contain adjustments to the cell calibration gain and offset over temperature.

The parameters concerned are the following

CTN	[-]	Number of temperature table points
CT1...CT5	[°C]	Indicated TEMP value at table point
CTO1...CTO5	mV/V	MV/V ($\times 10^4$) Offset adjustment at Offset table point
CTG1...CTG5	ppm	Gain ($\times 10^6$) at Gain table point

CTN sets the number of points in the gain & offset table's. A **CTN** value of less than two effectively switches off temperature compensation. The maximum number of point is 5, values greater than 5 reset **CTN** to 0 switching off temperature compensation.

CT1 to **CT5** sets the temperature in degree C of the correction points. The table must be filled from **CT1** up to & including **CT(CTN)** and must be entered in order of increasing temperature value.

CTO1 to **CTO5** provide the offset adjustment in $\text{mV/V} \times 10^4$. The reason for the multiplication is due to the limitation set by the ASCII protocol of only being able to enter up to 6 decimal places. The **CTOx** value is **subtracted** from the uncompensated value.

CTG1 to **CTG5** provide the gain adjustment in ppm terms. The actual gain value used is calculated as $1 + \text{CTGn} \times 10^{-6}$.

Internal Calculation

The temperature compensation calculation is described as follows:-

The GAIN correction is applied first. The current measured temperature is checked against the table values **CT1** to **CT(CTN)** to establish an index value if the measured temperature is below that of **CT1** then **CT1** is used as the index, If the temperature is above **CT(CTN-1)** then **CT(CTN-1)** is used.

This can be represented as follows:-

A working table index, **i**, is derived from the current measured temperature, **T**, as follows –

(**n** = number of points used, as set by **CTN**)

When (**T** < **CT1**) then **i** = 1

When (**T** > **CTn-1**) then **i** = (**n-1**)

Otherwise **i** is chosen so that $T_i \leq T \leq T_{i+1}$

Once an index into the table has been established the gain value to be used is extrapolated between the index value and the value above. If the temperature is above **CT(CTN)** or below **CT1** then the calculated temperature gain value is extrapolated from **CT(CTN-1)** to **CT(CTN)** or **CT1** to **CT2** respectively.

This can be represented mathematically as follows:-

$$\text{CALC_CTG} = \text{CTGi} + (\text{CTGi+1} - \text{CTGi}) \times (T - \text{CTi}) / (\text{CTi+1} - \text{CTi})$$

The actual gain value used is $1 + \text{CALC_CTGO} \times 10^{-6}$ and is multiplied by the uncompensated value **MV**.

The offset correction is then applied. Using the same temperature index “**i**” as found for the GAIN index above.

The Offset value is extrapolated between the same two temperature points.

This can be represented mathematically as follows:-

$$\text{CALC_CTO} = \text{CTO}_i + (\text{CTO}_{i+1} - \text{CTO}_i) \times (T - \text{CT}_i) / (\text{CT}_{i+1} - \text{CT}_i)$$

The actual offset value used is $\text{CALC_CTO} \times 10^{-4}$ and is subtracted from the above gain adjusted value.

The output from the temperature compensation (CMVV) is then calculated as

$$\text{CMVV} = \text{MVV} \times (1 + \text{CALC_CTGO} \times 10^{-6}) - (\text{CALC_CTO} \times 10^{-4})$$

The Temperature Measurement

The temperature sensor used is a Dallas (MAXIM) DS18S20 Digital Thermometer using the “1-Wire” bus technology. This gives a temperature measurement accuracy of +/-0.5 Degree C over the temperature range -10 to +85 degree C and +/-2.0 Degree C over temp range -55 to +125 Degree C. The resolution of the measurement is 0.0625 Degree C. The temperature is sampled and the **TEMP** variable updated every 5 seconds.

How to Set Up a Temperature Compensation

There are a number of ways of obtaining a temperature compensation curve.

The best possible compensation for a given piece of physical hardware can only be achieved by performing experiments on that particular unit (DCell/DSC and associated strain gauges), to characterise the measurement output at a variety of different, stable temperatures in the required operating range.

The basic choice of methods depends on trading off ideal accuracy against the complexity of the calibration procedure.

Method 1

Apply a simple linear drift correction (i.e. for known constant gain and offset changes per degree), by specifying zero correction at the calibration temperature, and appropriately adjusted correction values at extreme temperatures above and below this.

This can be used when the measurement or sensor has known temperature coefficients.

Method 2

Where the temperature characteristics of the measurement are known, but not linear, a similar scheme to Method 1 can be used, with a multi-point table defining an approximation to the known, ideal temperature curves of offset and gain variations.

NOTE: Both of the above methods are based on ‘known’ characteristics, which could come from datasheets but these methods would not compensate for the DCell/DSC.

Method 3

Do a series of measurements at different temperatures and install the appropriate correction values to give exactly correct results at those same temperatures -i.e. calculate ideal gain and offset corrections at the tested temperatures.

(This method is the most common). There is a ‘wizard’ available in Instrument Explorer which will enable this method to be easily completed by calculating the gain and offset corrections for you.

Method 4

Use a set of test results to plan a ‘best correction’ curve (not necessarily perfect at test temperatures, but slightly better overall).

NOTES:

All of these methods can be applied *either* to data from individual devices *or* to an ‘average’ correction for a particular type of sensor hardware.

During testing, temperatures should be measured using the internal TEMP measurement, as this is the measurement used to do the corrections.

For in-system tests, the environment of the DCell/DSC must always be as near as possible to the exact conditions of the eventual in-system use.

Parameter Calculations

Instrument Explorer provides a “Wizard” for the calculation of the parameters required by the DSC/DCell. This is based on Method 3 where data is collected. The wizard allows for small changes in the sampled temperature point that may occur when taking a set of results for gain and offset. Also taken into account is any variation in the test weights at different temperatures. This is a complex mathematical procedure which is best solved by a PC programme such as the wizard.

Chapter 6 Linearity Compensation

This chapter describes the Linearity Compensation features and how to use them.

Purpose and Method of Linearisation

Load cell sensor outputs are never precisely proportional to the input (applied load).

If the graph of the measurement output against the true value shows slight deviations from the ideal straight-line, then slight errors remain even when the basic calibration (offset and gain) is as good as possible.

Linearity compensation adjusts the raw measurement by a small amount that is calculated as a function of the raw measurement value itself. Ideally this will adjust the output response, for any given input load, by exactly the right amount to place the final result onto the ideal straight line.

The DCell/DSC non-linearity compensation uses a single ‘lookup table’, similar to those used for temperature compensation (see previous chapter). This provides a linearly-interpolated compensating value with up to 7 control points, which is then added to the output result.

Generally, linearisation is a finer level of compensation than temperature compensation.

It should only be applied after the basic Cell calibration and temperature compensation (if any) have been set up. Although the tests are generally simpler than testing over temperature, the accuracy requirement is often greater. See below for notes of possible difficulties to be avoided.

Control Parameters

Refer to the table in Chapter 9 for command numbers

The lookup table (based on parameters **CLXi**, **CLKi**) defines an offset adjustment based on the **CRAW** value, which is then added in to give the final **CELL** output.

(So linearity correction is applied after any temperature compensation.)

The Parameters Involved Are :

- CLN** Sets the number of linearisation points (from 2 up to 7)
- CLX1..7** Raw input (**CRAW**) value points
- CLK1..7** Output (**CELL**) adjustments to apply at these points

They are used like this :

- The number of calibration points is set by CLN (from 2 up to 7)
- Raw input value points are set by CLX1, CLX2 .. CLX7 (or up to the number set by CLN)
These *must* be arranged in order of increasing input value.
- The output corrections at these points are set by CLK1, CLK2 .. CLK7
- Corrections are specified in “**thousandths of a cell unit**”. So a CLKi of 1.0 actually adds 0.001 to the CELL output). This due to a limitation in the ASCII conversion to floating point numbers.

Internal Calculation

This uses the same basic ‘interpolated table lookup’ method as for temperature compensation.

First, a working table index, *i*, is derived from the current raw input **CRAW**=*x*, as follows :

(*n* = number of points used, as set by CLN)

When (*x* < CLX₁) then *i* = 1

When (*x* > CLX_{*n*-1}) then *i* = (*n*-1)

Otherwise *i* is chosen so that CLX_{*i*} ≤ *x* ≤ CLX_{*i*+1}

The resulting interpolated adjustment value is then calculated as -

$$ofs = CLK_i + (CLK_{i+1} - CLK_i) \times (x - CLX_i) / (CLX_{i+1} - CLX_i)$$

Then the compensated cell value is calculated as -

$$CELL = CRAW + ofs$$

How to Set Up Linearity Compensation

A linearity correction can be set up either from sensor specification/calibration data, or more commonly from in-system testing results.

Assuming we do not have any prior information on linearity errors, the usual approach is to do a series of controlled tests with accurately known test loads.

Just as with temperature compensation, it is *possible* to obtain a detailed graph of linearity error and then choose a 'best-fit' piecewise linear curve for the compensation table.

However, it is generally good enough, and much simpler, to simply test at several different points and then apply an exact correction at those points. If the error curve is reasonably smooth, this should give exact results at the test points, and reasonably accurate values in between.

NOTES:

Linearisation tests should only be done *after* the cell calibration is set, because the correction values are dependent on the cell calibration.

Similarly, linearisation testing should only be done at the calibration 'reference' temperature, or after temperature compensation is installed, to avoid temperature effects from distorting the results.

The linearisation tests should not reveal any significant remaining linear trend in the errors.

If errors do appear to lie on a definite line, this could drastically reduce the accuracy of the correction.

If this does happen, it shows that the cell calibration is wrong and should be redone.

The table points must always cover more-or-less the whole range of output values to be used, because corrections are extrapolated outward beyond the first and last points.

It is always worthwhile including more test-points than will be used in the correction table, because this gives confidence that no regions of rapidly changing error have been missed.

Tests should be done both with steadily increasing *and* decreasing load values, as hysteresis effects (for load cells) are often of a similar size to non-linearities.

Parameter Calculations and Example

Based on the simple method outlined above, we suppose that we have obtained test results for a series of precisely known load values -

test loads X_i give readings of CRAW = C_i , for ($i = 1..n$)

Then calculate the errors that need to be removed at these points -

$$E_i = X_i - C_i$$

Now just enter these values into the correction table, remembering to scale the errors -

$$CLN = n$$

$$CLX_i = X_i$$

$$CLK_i = 1000 \cdot E_i$$

Example

Suppose we have a load cell and Cell calibration giving a result in the range 0-500 KgF.

The following test results were obtained using a series of known test loads -

For test load of $x_1 = 0\text{Kg}$:	CELL reading $c_1 = 0.0010$
For test load of $x_2 = 100.13\text{Kg}$:	CELL reading $c_2 = 100.44$
For test load of $x_3 = 199.72\text{Kg}$:	CELL reading $c_3 = 200.57$
For test load of $x_4 = 349.97\text{Kg}$:	CELL reading $c_4 = 349.75$
For test load of $x_5 = 450.03\text{Kg}$:	CELL reading $c_5 = 449.98$

We choose these precise test points as our linearisation reference points, so

$$CLN = 5$$

$$CLX_1 = 0.0010$$

$$CLX_2 = 100.44$$

$$CLX_3 = 200.57$$

CLX4 = 349.75

CLX5 = 449.98

(Note that these are the raw reading values, not the known true values.)

Now calculate all the residual errors, and set up the correction factors -

$$\text{CLK1} = 10^3 \times (x_1 - c_1) \approx 1000 \times (000.00 - 0.0010) = -1.0$$

$$\text{CLK2} = 10^3 \times (x_2 - c_2) \approx 1000 \times (100.13 - 100.44) = -310.0$$

$$\text{CLK3} = 10^3 \times (x_3 - c_3) \approx 1000 \times (199.72 - 200.57) = -850.0$$

$$\text{CLK4} = 10^3 \times (x_4 - c_4) \approx 1000 \times (349.97 - 349.75) = +220.0$$

$$\text{CLK5} = 10^3 \times (x_5 - c_5) \approx 1000 \times (450.03 - 449.98) = +320.0$$

The CELL output values will now have the required values at all these 5 points.

Note on the Example

If you graph the errors from the above example, the results look like this

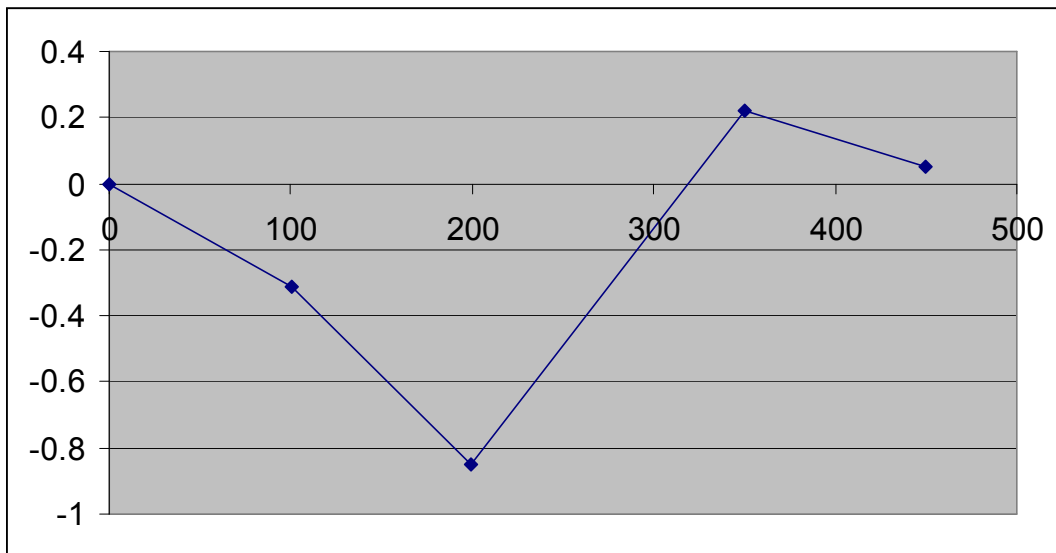

This doesn't show any very definite linear trend, so the calibration is okay.

However there *is* a big jump between points 3 and 4, which might be worth a more detailed investigation: Some important features of the error curve could have been missed by the test.

Chapter 7 Self-Diagnostics

Diagnostics Flags

The main diagnostics facilities are by means of the flags. See chapter 3 Flags for a full description of the flags and their meaning.

The flags are normally used something like this.

FLAG is read at regular intervals by the host (like the main output value, but generally at longer intervals)

If some warnings are active, i.e. **FLAG** is non-zero, then the host tries to cancel the warnings found by writing **FLAG= 0**

The host then notes whether the error then either remains (i.e. couldn't be cancelled), or if it disappears, or if it re-occurs within a short time, and will take action accordingly.

The warning flags are latched indicators of transient error events: By resetting the register, the host both signals that it has seen the warning, and readies the system to detect any re-occurrence (i.e. it resets the latch).

What the host should actually do with warnings depends on the type and the application: Sometimes a complete log is kept, sometimes no checking at all is needed.

Often, some warnings can be ignored unless they recur within a short time.

Warning flags survive power-down, i.e. they are backed up in non-volatile (EEPROM) storage.

Though useful, this means that repeatedly cancelling errors which then shortly recur can wear out the device non-volatile storage - see *WARNING: Finite Non-Volatile Memory Life* in chapter 3.

STAT provides a current status of the device. These flags are not latched and not saved on power fail.

Diagnostics LED

A new feature for Version 3 is the addition of an LED to indicate the current status of the device. If all is healthy the LED should flash ON for a period of 100mS , The rate at which the LED flashes is 0.5 second.

If an error conditions occurs which is based on any of the following error flags being set then the operation of the LED will invert. IE the LED will flash off for 100mS at the rate set in the table above.

These flags Being, TEMPUR, TEMPOR, ECOMUR, ECOMOR, CRAWUR, CRAWOR, SYSUR, SYSOR & LCINTEG.

Chapter 8 MantraCAN Communication Protocol

This chapter gives details of communication protocols and bus connections.

Each device has a single base ID to enable configuration and its factory set to 1. All data sent to the device is sent to this ID. All data returned from the device is on the base ID + 1.

The ID can be changed via standard parameters. Communications defaults are 500K bit rate with 11 bit identifier (CAN 2.0a)

Basic Command Structure

To read, write and issue commands the following protocol is used:

CAN ID	CAN Data		
	Descriptor	Command Number	Data
11 or 29 bit	1 Byte	1 Byte	4 Bytes

ID

The ID of the device. set by **NODEIDL** and **NODEIDH**. The size of the ID is set by **IDSIZE**

Descriptor

The Descriptor is used to indicate the type of message, a message can be one of the following types:-

- Write which writes a new value into a parameter, Write is also used to perform an action command such as **RST**, in which case no data is sent.
- Read is used to read back the value of a parameter.
- Response is always sent by the slave on receipt of a valid message. The response always returns the command number byte sent by the master.
- A NAK is sent if the Command index is not recognised or if the data sent is invalid.

Type	Descriptor Value
Read	1
Write	2
Response	6
NAK	21

Command Number

Refer to the table in Chapter 9 for command numbers

Data

Data is **ALWAYS** in the format of a floating point number to the IEEE 854-1987 standard. When requesting parameter values do not use data. Also do not use data when issuing a command.

Read

To **read a parameter** send message to appropriate ID with a Request descriptor, data will be ignored so can optionally be left off.

CAN ID	CAN Data	
	Descriptor	Command Number
Base ID	Read	1 Byte

Then wait a timeout period for a message of the Base ID+1 marked as either **Response** or **NAK** descriptor. If a response descriptor is received then the result will be in the data part. The Command number in the reply will match the transmitted Command number.

Successful Response From Slave

CAN ID	CAN Data		
	Descriptor	Command Number	Data
Base ID + 1	Response	1 Byte	4 Bytes

Not Acknowledged Response From Slave

CAN ID	CAN Data	
ID + 1	Descriptor	Command Number
11 or 29 bit	NAK	1 Byte

The reason for a NAK response would be if the command number does not exist in the device.

Example of Read

The following example is to read SYS from an ID of 100.

Message from Master

CAN ID	CAN Data		
Base ID	Descriptor	Command Number	
0x64	0x1	0xA	Hexadecimal
100	1	10	Decimal

Successful Response From Slave. The value returned is 123.456

CAN ID	CAN Data			
Base ID + 1	Descriptor	Command Number	Data	
0x65	0x6	0xA	0x3F, 0x80, 0x00, x00	Hexadecimal
101	6	10	63, 128, 0, 0	Decimal

Not Acknowledged Response From Slave. For example if the device did not support command number 10

CAN ID	CAN Data		
Base ID + 1	Descriptor	Command Number	
0x65	0x15	0xA	Hexadecimal
101	21	10	Decimal

Write

To **write a parameter** send message to appropriate ID with a Write descriptor and IEEE floating point data.

Message From Master

CAN ID	CAN Data		
Base ID	Descriptor	Command Index	Data
11 or 29 bit	Write	1 Byte	4 Bytes

Then wait a timeout period for a message of the same ID marked as either Response or NAK descriptor. If a response descriptor is returned then this acknowledges receipt but does not contain data.

Successful Response From Slave.

CAN ID	CAN Data	
Base ID + 1	Descriptor	Command Index
11 or 29 bit	Response	1 Byte

Not Acknowledged Response From Slave.

CAN ID	CAN Data	
Base ID + 1	Descriptor	Command Index
11 or 29 bit	NAK	1 Byte

Example of Write

The following example is to write ID 100 the value -100.0 to SZ.

Message from Master

CAN ID		CAN Data		
Base ID + 1	Descriptor	Command Number	Data	
0x64	0x2	0x16	0xC2, 0xC8, 0x00, x00	Hexadecimal
100	2	22	194, 200, 0, 0	Decimal

Successful Response From Slave.

CAN ID		CAN Data		
Base ID	Descriptor	Command Number		
0x65	0x6	0x16		Hexadecimal
101	6	22		Decimal

Not Acknowledged Response From Slave. For example if the data was out of range

CAN ID		CAN Data		
Base ID + 1	Descriptor	Command Number		
0x65	0x15	0xA		Hexadecimal
101	21	10		Decimal

Execute A Command

To **execute command** send message to appropriate ID with a Write descriptor and no data.

Message From Master

CAN ID		CAN Data		
Base ID	Descriptor	Command Index		
11 or 29 bit	Write	1 Byte		

Then wait a timeout period for a message of the same ID marked as either Response or NAK descriptor.
If a response then this acknowledges receipt and does not contain data.

Successful Response From Slave.

CAN ID		CAN Data		
Base ID + 1	Descriptor	Command Index		
11 or 29 bit	Response	1 Byte		

Not Acknowledged Response From Slave.

CAN ID		CAN Data		
Base ID + 1	Descriptor	Command Index		
11 or 29 bit	NAK	1 Byte		

Example Of Execute A Command

The following example is to execute RST command to ID 100.

Message from Master

CAN ID		CAN Data		
Base ID	Descriptor	Command Number		
0x64	0x2	0x64		Hexadecimal
100	2	100		Decimal

Successful Response From Slave.

CAN ID	CAN Data		
Base ID	Descriptor	Command Number	
0x65	0x6	0x64	Hexadecimal
101	6	100	Decimal

Not Acknowledged Response From Slave. For example if the device did not support command number 100

CAN ID	CAN Data		
Base ID + 1	Descriptor	Command Number	
0x65	0x15	0x64	Hexadecimal
101	21	100	Decimal

Data Type Conversions and Rounding

Type Conversion

Depending on the protocol, an integer/byte parameter may need to be converted to or from a floating-point representation for reading or writing.

The rules are as follows

For reading, integer and byte parameters are treated as unsigned, and never read negative

- i.e. read value ranges are 0 to 65535.0 and 0 to 255.0

For writing, values written to integer and byte parameters are truncated to the nearest integer, and negative or positive values are acceptable

NOTE: Floating-point data is not always exact, even when reading integral data

E.G. could get 3.999974 instead of 4

E.G. for a byte write 240, 240.1 and 239.66 are all the same value

Rounding

Although rounding is applied when writing to integral values, data read from a device is *not* rounded off.

Chapter 9 Software Command Reference

This chapter contains tables of all DCell/DSC commands, with brief details of each.

Commands in Access Order

Name	Description	Access	Command Number
CMVV	Temp Compensated mV/V	RO	5
STAT	Status	RO	6
MVV	Filtered & factory calibrated mV/V	RO	8
SOUT	Selected output (copy of SYS)	RO	9
SYS	Main output	RO	10
TEMP	Temperature	RO	11
SRAW	Raw System output	RO	12
CELL	Cell output	RO	13
FLAG	Error flags	RW	14
CRAW	Raw cell output	RO	15
ELEC	Electrical output	RO	16
SZ	System zero	RW	22
SYSN	Snapshot result	RO	23
PEAK	Peak value	RO	24
TROF	Trough value	RO	25
CFCT	Communications failure count	RW	26
VER	Software version	RO	30
SERL	Serial number low	RO	31
SERH	Serial number high	RO	32
RATE	Reading rate select	RW	36
NMVV	Nominal mV/V for scaling ELEC	RW	39
CGAI	Cell gain	RW	40
COFS	Cell offset	RW	41
CMIN	Cell range min	RW	44
CMAX	Cell range max	RW	45
CLN	Number of Linearisation points	RW	50
CLX1..7	Linearisation raw-values	RW	51..57
CLK1..7	Linearisation corrections	RW	61..67
SGAI	System gain	RW	70
SOFS	System offset	RW	71
SMIN	System range min	RW	74
SMAX	System range max	RW	75
USR1..9	User storage values	RW	81..89
FFLV	Dynamic Filter Level	RW	92
FFST	Dynamic filter steps	RW	93
RST	Reset	X	100
SNAP	Take snapshot	X	103
RSPT	Reset peak & trough	X	104
SCON	Shunt cal ON	X	105
SCOF	Shunt cal OFF	X	106
OPON	Digital Output on	X	107
OPOF	Digital output off	X	108
CTN	Number of Temperature Compensation points	RW	110
CT1..5	Temperature Compensation Point	RW	111..115
CTG1..5	Temperature Compensation Gain adjust	RW	116..120
CTO1..5	Temperature Compensation Offset Adjust	RW	121..125
STRMON	Start Data Streaming	X	128
STRMOFF	Stop Streaming Data	X	129

STRMTYPE	Stream Type		130
NODEIDL	Low word of CAN ID	RW	131
NODEIDH	High Word of CAN ID	RW	132
BPS	CAN Bit Rate	RW	133
IDSIZE	CAN ID Size 11 or 29 Bit	RW	134
CANTXERR	CAN Transmit Error Count	RO	135
CANRXERR	CAN Receive Error Count	RO	136
CANSTATUS	CAN Status Flag	RO	137
RSTCANFLG	Reset Can Status Flag	X	138
MSG1EN	Enable message 1	RW	140
MSG1IDL	Low word of message 1 CAN ID	RW	141
MSG1IDH	High Word of Message 1 CAN ID	RW	142
MSG1PL	Message 1 Packet length (1 - 8)	RW	143
MSG1B1	Byte 1 value	RW	144
MSG1B2	Byte 2 value	RW	145
MSG1B3	Byte 3 value	RW	146
MSG1B4	Byte 4 value	RW	146
MSG1B5	Byte 5 value	RW	148
MSG1B6	Byte 6 value	RW	149
MSG1B7	Byte 7 value	RW	150
MSG1B8	Byte 8 value	RW	151
MSG1SRC	CAN command number for required Data	RW	152
MSG1FM	Data Format	RW	153
MSG1SFM	Data Sub Format	RW	154
MSG1SP	Position to place Data in Packet	RW	155
MSG1GAI	Gain to apply to data	RW	156
MSG1OFS	Offset to apply to Data	RW	157
MSG1INT	Interval to send Data in ms	RW	158
MSG1TRG	Trigger Type	RW	159
MSG2EN	Enable message 2	RW	160
MSG2IDL	Low word of message 2 CAN ID	RW	161
MSG2IDH	High Word of Message 2 CAN ID	RW	162
MSG2PL	Message 1 Packet length (1 - 8)	RW	163
MSG2B1	Byte 1 value	RW	164
MSG2B2	Byte 2 value	RW	165
MSG2B3	Byte 3 value	RW	166
MSG2B4	Byte 4 value	RW	166
MSG2B5	Byte 5 value	RW	168
MSG2B6	Byte 6 value	RW	169
MSG2B7	Byte 7 value	RW	170
MSG2B8	Byte 8 value	RW	171
MSG2SRC	CAN command number for required Data	RW	172
MSG2FM	Data Format	RW	173
MSG2SFM	Data Sub Format	RW	174
MSG2SP	Position to place Data in Packet	RW	175
MSG2GAI	Gain to apply to data	RW	176
MSG2OFS	Offset to apply to Data	RW	177
MSG2INT	Interval to send Data in ms	RW	178
MSG2TRG	Trigger Type	RW	179
MSG3EN	Enable message 3	RW	180
MSG3IDL	Low word of message 3 CAN ID	RW	181
MSG3IDH	High Word of Message 3 CAN ID	RW	182
MSG3PL	Message 3 Packet length (1 - 8)	RW	183
MSG3B1	Byte 1 value	RW	184
MSG3B2	Byte 2 value	RW	185

MSG3B3	Byte 3 value	RW	186
MSG3B4	Byte 4 value	RW	186
MSG3B5	Byte 5 value	RW	188
MSG3B6	Byte 6 value	RW	189
MSG3B7	Byte 7 value	RW	190
MSG3B8	Byte 8 value	RW	191
MSG3SRC	CAN command number for required Data	RW	192
MSG3FM	Data Format	RW	193
MSG3SFM	Data Sub Format	RW	194
MSG3SP	Position to place Data in Packet	RW	195
MSG3GAI	Gain to apply to data	RW	196
MSG3OFS	Offset to apply to Data	RW	197
MSG3INT	Interval to send Data in ms	RW	198
MSG3TRG	Trigger Type	RW	199
MSG4EN	Enable message 4	RW	200
MSG4IDL	Low word of message 4 CAN ID	RW	201
MSG4IDH	High Word of Message 4 CAN ID	RW	202
MSG4PL	Message 4 Packet length (1 - 8)	RW	203
MSG4B1	Byte 1 value	RW	203
MSG4B2	Byte 2 value	RW	205
MSG4B3	Byte 3 value	RW	206
MSG4B4	Byte 4 value	RW	207
MSG4B5	Byte 5 value	RW	208
MSG4B6	Byte 6 value	RW	209
MSG4B7	Byte 7 value	RW	210
MSG4B8	Byte 8 value	RW	211
MSG4SRC	CAN command number for required Data	RW	212
MSG4FM	Data Format	RW	213
MSG4SFM	Data Sub Format	RW	214
MSG4SP	Position to place Data in Packet	RW	215
MSG4GAI	Gain to apply to data	RW	216
MSG4OFS	Offset to apply to Data	RW	217
MSG4INT	Interval to send Data in ms	RW	218
MSG4TRG	Trigger Type	RW	219
SONIDL	Custom Start ID Low	RW	220
SONIDH	Custom Start ID High	RW	221
SONB1	Custom Start Data Byte 1	RW	222
SONB2	Custom Start Data Byte 2	RW	223
SONB3	Custom Start Data Byte 3	RW	224
SONB4	Custom Start Data Byte 4	RW	225
SONB5	Custom Start Data Byte 5	RW	226
SONB6	Custom Start Data Byte 6	RW	227
SONB7	Custom Start Data Byte 7	RW	228
SONB8	Custom Start Data Byte 8	RW	239
SOFFIDL	Custom Stop ID Low	RW	240
SOFFIDH	Custom Stop ID High	RW	241
SOFFB1	Custom Stop Data Byte 1	RW	242
SOFFB2	Custom Stop Data Byte 2	RW	243
SOFFB3	Custom Stop Data Byte 3	RW	244
SOFFB4	Custom Stop Data Byte 4	RW	245
SOFFB5	Custom Stop Data Byte 5	RW	246
SOFFB6	Custom Stop Data Byte 6	RW	247
SOFFB7	Custom Stop Data Byte 7	RW	248
SOFFB8	Custom Stop Data Byte 8	RW	249

Table Key

“..” - Denotes a range (e.g. CLK1..7 means “CLK1” to “CLK7”)

Access RW/RO/WO/X = read-write / read-only / write-only / execute

Chapter 10 Installation

This chapter gives detailed information on integrating DCell and DSC devices into a production system - including mounting, protection, adjustments, wiring and electrical requirements.

Before Installation

Carefully remove the DCell/DSC device from its shipment box. Check that the device is complete and undamaged. Check the Product Type Code - on the product label is that which you ordered.

The DCell/DSC can operate in any industrial environment providing the following limits are not exceeded

Operating Temperature	-40 °C to +85 °C
Humidity	95% non condensing
Storage temperature	-40 °C to +85 °C

For precise details of Environmental Approvals, see chapter 15.

It Is Advisable To Follow The Following Installation Practice Where Possible

- Minimise vibration
- Do not mount next to strong electrical or magnetic fields (transformers, power cables)
- Install electrical protection device as the unit is not internally fused
- Always ensure the package is secure and protected

Physical Mounting

DCell is normally sealed in the pocket of the load cell, which provides mechanical and moisture protection, and electrical shielding.

The DCell should be mounted using a 2mm screw to the body of the load cell. This should be a “Good” electrical connection to obtain maximum performance.

Connecting wires are soldered directly to the pads on the top and/or bottom of the PCB. Care must be taken to electrically insulate the connection pads from the surrounding metal.

DSC is normally installed in a protective enclosure, such as a metal box.

The pins can be plugged into standard (0.1” pitch) PCB header sockets, or soldered directly into a host board or to connecting wires.

It can be mounted either way up. Unwanted pins projecting on one side may be cropped off.

For extra vibration resistance, the 3 mounting holes provided can be used.

If not required, the protruding end with the single hole can be cut off to make the board smaller.

Electrical Protection

No additional electrical shielding is normally needed.

Electrostatic protection is sufficient for installation purposes only.

Devices are protected against shorting of communications lines to power supply, and shorting of sensor inputs.

No over-current protection is provided in case of faults, so the supply arrangements should ensure adequate power limiting or fusing.

NOT PROTECTED AGAINST REVERSE POLARITY OF SUPPLY

Moisture Protection

Both DCell and DSC must only be operated in a dry environment, as moisture can dramatically degrade the measurement performance.

DCell

Will normally be sealed into a load cell pocket.

While flexible silicone sealant can be used to completely embed the unit, this is not adequate moisture protection in itself.

If required, the entire unit can be embedded in a potting compound: A two-part epoxy compound can be used, but bubbles and gaps must be avoided to prevent mechanical stress which could break the device.

The compound used must be specified for electrical use, and have sufficient thermal conductivity to cope with the heat given off (up to 1W on a 15V supply).

DSC no additional electrical shielding is required, but moisture and/or mechanical protection are often required. Any simple box or enclosure can be used. If metal, the enclosure should be earthed to the SH connection (see

Communications Cabling and Grounding Requirements below).

Soldering Methods

Take care soldering cables to the pads. Use a temperature controlled soldering iron set to a maximum 330°C, for no longer than 2 seconds per pad. Excessive heat or increased soldering time may result in damage to the PCB.

NOTES:

1. Solder with water-soluble flux should not be used (even low-residue), as this can leave a surface film which attracts atmospheric moisture, degrading measurement performance.



2. DCell units can be damaged by poor soldering, due to the small nature of the circuit boards: Overheating or applying any pressure to a pad can de solder components on the other side of the board, or cause the pad itself to become detached.

Power Supply Requirements

The power supply needed is nominally 5.6 to 18V DC, but any possible droop or ripple must be included: The devices contain 'brown-out' detection, which may trigger if the supply voltage at the device drops below the 5.6 volts.

A single device consumes typically 40mA with a 350Ω gauge connected (except RS232-output units, which use about 10mA more).

An installation should therefore assume at least 60mA per unit, and allow for extra current being taken at power-on (though supply voltage can safely drop temporarily), and for possible voltage drops in long cables.

Any power-supply ripple should be below 100mV, and supply arrangements should provide current limiting for fault conditions (see *Electrical Protection*, above).

Cable Requirements

Strain Gauge input (DSC)

For optimal performance twin twisted pair with individual shields is recommended, this gives good noise immunity. Maximum length should not exceed 20m. Normal 4 core shielded cable can be used in areas of low electromagnetic noise.

Power and Communication

Again, twin twisted pair cable is recommended for this. The cable should have the following characteristics.

- Twisted-pair with independent shields
- Characteristic impedance 50-150 ohms.
- Core to core and core to shield capacitance below 300pF/m

A suitable type is BICC Brand-Rex BE56723 (also equivalent to Belden type 8723).

In the UK, this is available from Farnell, part number 118-2117

Temperature Sensor

A shielded twisted pair is recommended, with a maximum length of 10m the shield being connected to the load cell body or (SH if DSC). For short lengths (< 2m) in a low noise environment (inside load cell body for example) then normal cable can be used.

Identifying Strain Gauge Connections

DCell Input Connections

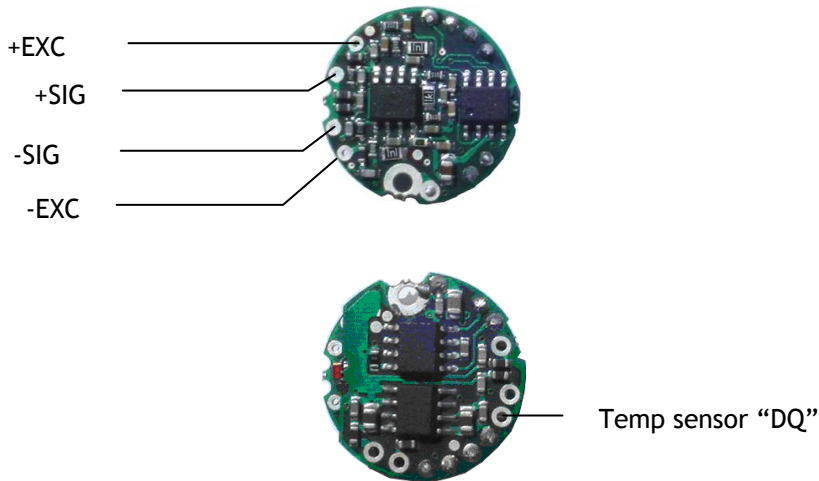

The Optional Temperature sensor has two connections, "DQ" which provides the bi-directional data line and -EXC which provides the 0v connection.

DSC Input Connections



Strain Gauge Bridge Connections Are As Follows

- EXC+/- positive/negative excitation (supply)
- SIG+/- positive/negative output signal
- SH Shield connection for shield of strain gauge cable
- GND can be used as the ground connection for the temperature sensor

Other Connections (DSC ONLY)

Resistor RG and track-cut TC are used to adjust the mV/V sensitivity (see *Strain Gauge Sensitivity Adjustment*, below).

Identifying Bus-End Connections

DCell Bus Connections

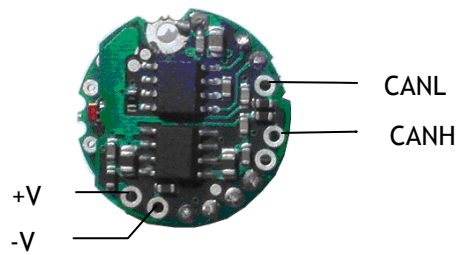

DSC CAN Versions-Bus Connections

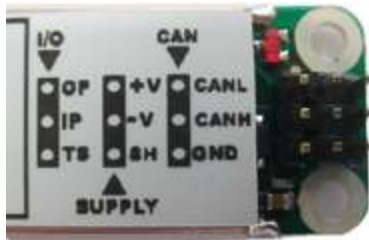

- +V and -V are the DC power-supply and return connections
- CANH & CANL are the CAN communications connections
- GND is a communications ground connection
- SH is the shield ground, used for shielding and grounding only
- OP is the open collector digital output
- IP is the volt free digital input
- TS connects to DQ of the optional temperature sensor

Strain Gauge Cabling and Grounding Requirements

To achieve full performance specifications and conform to environmental approvals, it is important to follow the wiring procedures outlined in this section.

DCell Strain Gauge Wiring

The following diagram illustrates how to wire up a DCell to a strain gauge

DCell Strain Gauge Wiring Arrangement

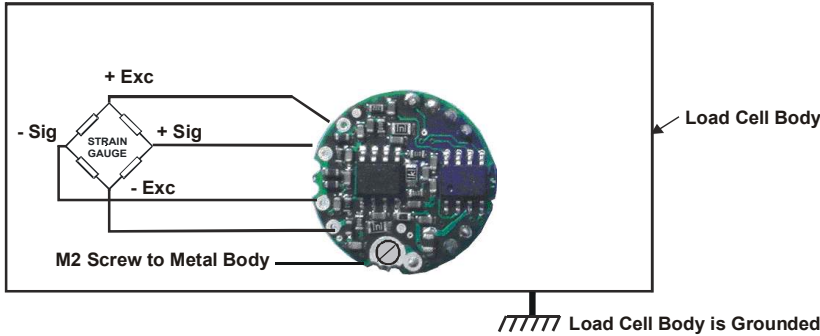

Key Requirements

All the load cell wires should be kept as short as feasible, at most 20cm. The EXC+/- wires should be twisted together, also the SIG+/- pair, and the two pairs kept apart. It is also recommended to secure the wires from moving due to shock or vibration. If the DCell is mounted outside the body of the load cell then, for optimal performance, twin twisted cable should be used, although standard 4 core shield cable can be used in low noise environments.

The M2 mounting hole **must be grounded** via an M2 screw to the load cell body for specified performance to be met. (The 2mm mounting hole to accept M2 screw or American equivalent #0-80. Important Note: DO NOT USE #2 screw size.)

DSC Strain Gauge Cabling Arrangement

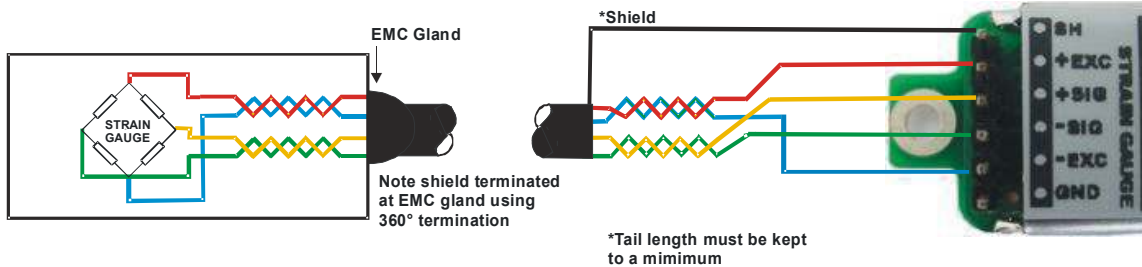

Key Requirements

The Strain Gauge cable should be a twin twisted pair with independent shields, with the two pairs used for the EXC and SIG signal-pairs.

For specified performance, the load cell must be grounded to the SH.

DSC Sensor Cable

require 2 × twisted-pair version, otherwise similar to the above.

A suitable type is BICC Brand-Rex PD3003 (also equivalent to Belden type 8777).

In the UK, this is available from Farnell (enter 'Belden 8777' for real length options).

Communications Cabling and Grounding Requirements

To achieve full performance specifications and conform to environmental approvals, it is important to follow the wiring procedures outlined in this section.

DCell Power and Communications Wiring

The following diagram illustrates how to connect a puck to the communications and power supply (“bus”) cable.

DCell Bus-End Arrangement

Note: The specified cable above shows a yellow wire this will be replaced with a white wire.

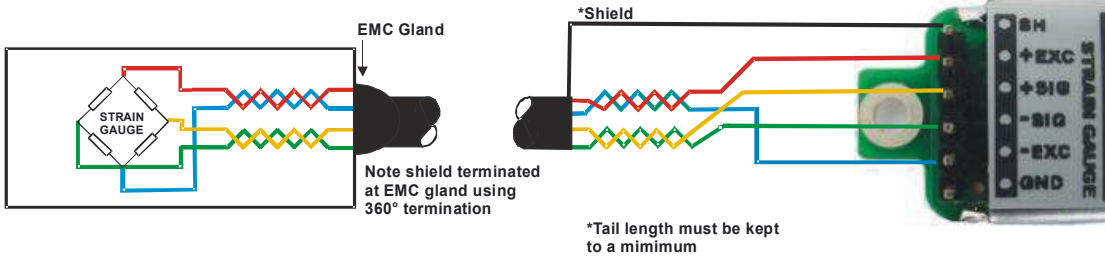

Key Requirements

The cable must enter the load cell via an EMC cable gland, which connects the cable shield to the load cell body. This must be a 360 Degree connection

The cable should be a twin twisted pair with independent shields, with one pair used for the communications and the other for the power wires.

There MUST be a common connection from the PSU and the CAN ground to ensure the CAN stays within the required common mode voltage of -2v (CANL) to +7v (CANH).

The shield should be connected to the earthed enclosure of the power supply.

DSC4 Versions- Power and Communications Wiring

The following diagram illustrates how to connect a DSC4 card to the communications and power supply (“bus”) cable.

DSC4 Versions-Bus-End Arrangement

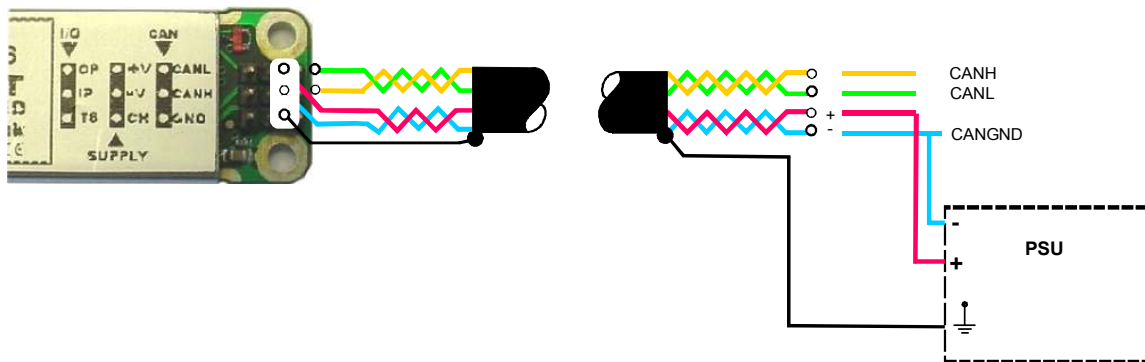

Note: The specified cable above shows a yellow wire this will be replaced with a white wire.

Key Requirements

The cable should be a twin twisted pair with independent shields, with one pair used for the communications and the other for the power wires.

The cable shield must be grounded to the SH pin at the DSC end, and *not* at the host end.

Any further metal housing should also be grounded to the DSC SH pin, and should *not* be connected to the bus cable shield (or the sensor cable).

There MUST be a common connection from the PSU and the CAN ground to ensure the CAN stays within the required common mode voltage of -2v (CANL) to +7v (CANH).

Suitable Cable Types

DCell/DSC CAN Bus Cable

The Cable requirements are dependent on the bit rate of the CAN bus and the required distances. Special care is required for bit rates of over 500Kbps not only in the choice of cable used but how the bus wiring is organised ie the requirement for very small stub lengths for high bit rates.

For low bit rates the requirements can be specified as follows

A suitable type is BICC Brand-Rex BE56723 (also equivalent to Belden type 8723).

In the UK, this is available from Farnell, part number 118-2117.

For bit rates above 500Kbps the following is recommended

Belden B3084A

Belden B8132

Indication Of Maximum Bus Length

The following indication is for the communications lines only. It does not include the power lines, which may limit the length further due to voltage drops and initial power supply level.

Bit Rate	Maximum Line length
1Mbits/s	25m
800Kbits/s	50m
500Kbits/s	100m
250Kbits/s	250m
125Kbits/s	500m
50Kbits/s	1000m
20Kbits/s	2500m

CAN Bus Connections for Multiple DCells

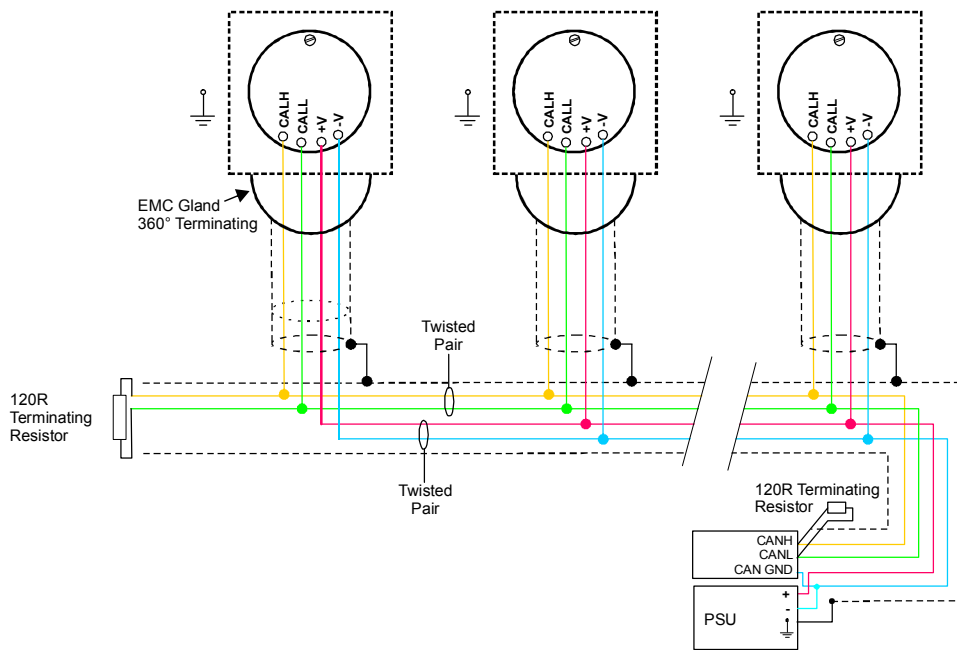

CAN Bus Connections for Multiple DSC Versions

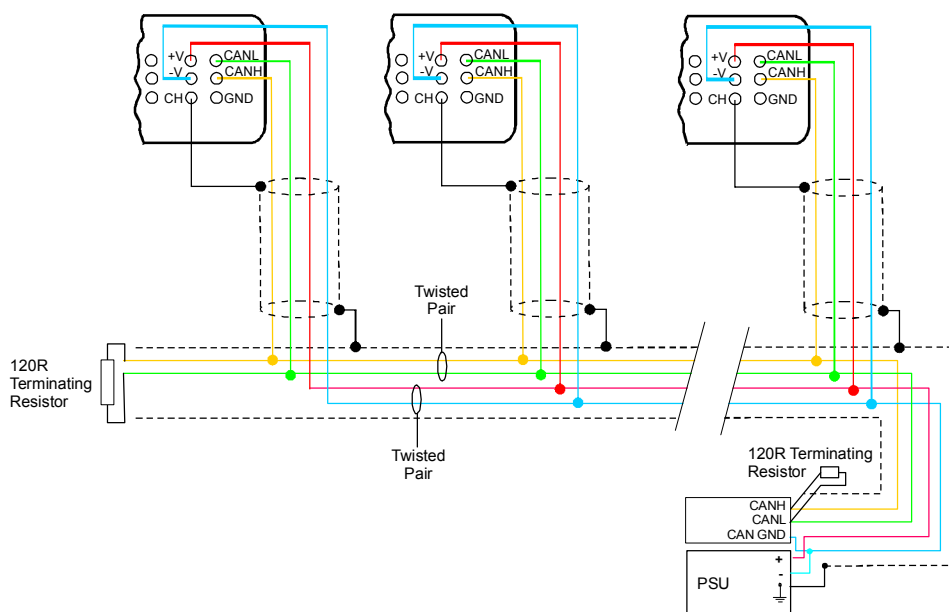

Note : The specified cable above shows a yellow wire this will be replaced with a white wire

Key Requirements

- The main bus cable must be terminated at either end
- Where the bus does not go directly to each attached device, each 'stub' cable connecting to the bus should have just one device on it
- Stub branches should be kept as short as possible
- Stubs are not terminated

Bus Layout and Termination

The ideal bus is a single length of cable, terminated at either end. Each end connects to a communicating device; while other devices are connected as near as possible directly to the main bus as it passes them (i.e. not on long side-branches).

The bus must be terminated at both ends to avoid reflections. Connecting a 120 Ohm resistor between the CANH and CANL lines does this.

Loading

It is important that the bus is loaded at each end with the corresponding line impedance, this is normally 120Ohm

Strain Gauge Sensitivity Adjustment (DSC ONLY)

For DCell strain gauge sensitivity adjustment please consult factory.

If your strain gauge does not deliver a 2.5mV/V full scale output, you may want to adjust the sensitivity of the electronics (hardware) and/or the software gain controls.

If you want to test with an input of *more* than 2.5mV/V, you will have to adjust the hardware sensitivity to avoid saturating the input. If it is less, you can correct in software alone, but increasing sensitivity will generally improve accuracy.

To adjust the mV/V for DSC, an extra resistor 'Rg' is fitted across the pads RG, as shown above, in

Identifying the DSC 'Rg' Resistor

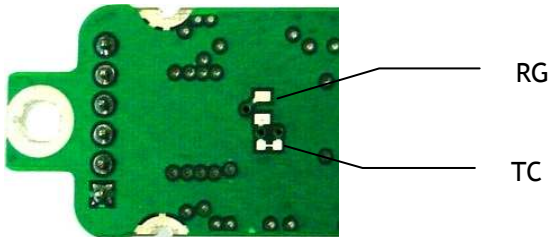

Identifying Sensor End Connections

The link across TC can be cut to disconnect the internal 100R gain resistor: This is needed for lowering the sensitivity.

The resistor is 0805 size surface mount chip.

A 0.1%, 5ppm/Deg C resistor for the high stability version & 25ppm/ Deg C for the Industrial must be used to maintain performance.

Reducing Sensitivity

To accommodate a maximum sensor output *larger* than 2.5mV/V, it is necessary to reduce the electrical sensitivity of the input circuitry.

To decrease sensitivity, the link **TC** is cut, and the value of the resistor fitted, in Ω , should be -

$$R_g = (\text{required mV/V}) \times 40$$

Example: For 10mV/V

$$R_g = 10 \times 40 = 400\Omega$$

Increasing Sensitivity

When the full-scale output is *smaller* than 2.5 mV/V, it may be desired to increase sensitivity. However, it is often possible instead to compensate partly or entirely in software, by increasing a software gain control CGAI or SGAI

To *increase* sensitivity, TC is left in place, so that the fitted Rg appears in parallel (this gives better temperature stability). Its value should then be

$$RG = 1 / ((0.025 / r_{qd} \text{ m V/V}) - 0.01)$$

Two effects should be noted

1. The purpose of increasing sensitivity is to reduce reading *noise*, which governs the effective resolution. Using software gain alone obviously gives reduced performance.
2. The sensitivity should, however, not be set greater than typically 1mV/V: Beyond this, input noise usually dominates and no extra benefit can be achieved.

Chapter 11 Troubleshooting

This chapter gives a quick guide to problem solving for DCell/DSC devices.

Bear in mind that the quickest way to pin down problems is to usually replace items with 'known good' alternatives. This also applies to cables, power supplies, devices etc.

LED Indicator

The LED is used to indicate the protocol selection, the device is powered and the Device is Operating. For correct operation the LED should Flash ON for 100mS then repeat at a rate depending on the protocol. See table below. If this is not the case then follow the instructions below.

If the LED is OFF check the power supply polarity & voltage. The voltage including any troughs should be above 5.6V and less than 18V. If the supply polarity and voltage is correct then switch off, remove the strain gauge from circuit and switch on. If the LED is still off check the current drawn by the device. With no strain gauges should be approx 30mA.

If the LED is permanently ON then contact factory.

If The LED is ON for the majority of time then Flashes OFF for 100mS then a fault exists. This Fault can be read back using the communications. Likely causes of this are Strain Gauge Integrity error or Limits reached for MVV, CRAW, SRAW or TEMP. First check the connections to the strain gauge are correct. Next check the input is not over-range or the limits set for CMIN, CMAX, SMIN or SMAX have not been exceeded.

No Communications

The majority of problems involve a failure to communicate, as there are a number of optional settings that must be set the same at both ends of the link.

For this reason, any communications application should always check command responses, and flag a problem when there these responses are not activated.

Possible problems can be categorised according to where in the 'chain' of communication the problem may be. The typical chain runs as follows,

- PC software (port connection, baud rate, station number, protocol)
- PC USB (working)
- PC CAN drivers
- USB-CAN device
- Bus wiring
- Device (wiring, ID, bit rate, working)

Bad Readings

The cause can be either hardware or software related.

Software

1. Check the MVV reading first and ensure it is correct. This figure is the RAW input and is not affected by the user configurable calibration settings.
2. If MVV looks correct, check the calibration settings step by step.
Consider resetting all the calibration controls to default values - see *Calibration Parameters Summary and Defaults* in *Chapter 4 The Readings Process*. Hardware
3. Load Cell problem should be indicated by Flag LCINTEG in STAT.
4. Genuine hardware problems usual show up as total failure - i.e. no reading = always unchanging, usually near zero, sometimes always full-scale.
Check wiring, take voltage level readings and again if possible use a known good device and set up.
5. Check the sensor is connected properly, and has some resistance across excitation wires, and around 350 Ohms across output wires (when disconnected from device).
6. Check for damaged DCell/DSC device by replacement

Unexpected Warning Flags

Remember that all warning flags in FLAG must be explicitly reset -they do not clear themselves when a problem is resolved.

If a flag cannot be cleared, the cause must be persistent -i.e. it keeps happening again. This can be immediate, regular (every few seconds) or irregular (occasional).

See *Self Diagnosis* for precise details of how the individual warnings operate.

Bear In Mind The Following Possible Problems

1. REBOOT or COMMSFAIL may indicate intermittent connections.
2. Where ECOMUR/OR or EXCUR/EXCOR are triggered, suspect input wiring.
3. Various 'range' errors (CRAWUR/OR, SRAWUR/OR) are also likely to be set if the excitation was interrupted (EXCUR/OR).
4. For range errors, check the associated limit parameters (CMIN/MAX, SMIN/MAX).
5. Problems are likely if any calibration MIN/MAX parameters are set the wrong side of zero (i.e. MIN>0 or MAX<0).

Problems with Bus Baud Rate

There are a number of special difficulties to be considered here

- Systems with very long cabling may not work with higher bit rates
- Always remember you need to reboot devices before the change takes effect

Difficult problems can always be overcome, if necessary, by isolating individual devices and trying the different bit rates in turn. This deals with all possible problems, as long as your hardware can deliver all the supported baud rates.

Recovering a "lost" DCell/DSC

Resetting to default ID

Due to the configure ability of the devices CAN settings it is important to note all changes made to these settings or you may lose the ability to communicate with the device. In particular if the ID is changed from the default it would be very difficult to find the ID by trial and error as there are 2047 possible ID's available on a Can 2.0a 11 bit system and 536,870,911 for Can 2.0b 29 bit identifiers.

For this reason the DSC has a built in mechanism to reset the base ID back to the default value of 1.

To activate this recovery mode the device must be sent 2 commands over the CAN Bus on the broadcast ID of 0 with the second command being sent within 2 seconds of the first.

It is important that the device to be reset is the only device to be connected on the CAN bus otherwise all devices will be reset to the default!!

Each Command consists of 7 ASCII Bytes as its Data message bytes shown below.

First Command

	Byte							
	1	2	3	4	5	6	7	8
ASCII	M	A	N	T	R	S	T	Blank
DECIMAL	77	65	78	84	82	83	84	Blank
HEX	4D	41	4E	54	52	53	54	Blank

Second Command

must be sent within 2 seconds of First Command

	Byte							
	1	2	3	4	5	6	7	8
ASCII	D	O	R	E	S	E	T	Blank
DECIMAL	68	79	82	69	83	69	84	Blank
HEX	44	4F	52	45	53	45	54	Blank

After sending the command sequence recycle the power to the DSC the DSC will then have the default base ID of 1.

Chapter 12 Specifications

Technical Specifications DSC/DCELL High Stability

Set for 2.5mV/V sensitivity

Parameter	Min	Typical	Max	Units
Strain Gauge Excitation System	4 Wire			
Strain Gauge Excitation Voltage	4.5	5	5.25	VDC
Strain Gauge Drive Capability	320	-	5000	Ohms
Strain Gauge Sensitivity	-3	2.5	3	mV/V
Offset Temperature Stability		1	4	ppm/C
Gain Temperature Stability		3	5	ppm/C
Offset Stability with Time		20	80	ppm of FR (1)
Gain Stability with Time			30	ppm of FR (2)
Non Linearity before Linearization		5	25	ppm of FR
Internal Resolution		16 Million		Counts/divs
Resolution @ 1Hz readings (Noise stable) over 100s		200,000		Counts/divs
Resolution @ 10Hz readings (Noise stable) over 100s		120,000		Counts/divs
Resolution @ 100Hz readings (Noise stable) over 100s		50,000		Counts/divs
Signal Filter	Dynamic recursive type user programmable			
Optional Temperature Resolution				
Temperature Measurement Resolution		0.0625		Deg C
Temperature Measurement Accuracy (-10 to 85)		0.5		Deg C
Temperature Measurement Accuracy (-55 to 125)		2.0		Deg C
Temperature update Speed		5		Seconds
Electrical				
Power Supply voltage	5.6	12	18	V dc
Power Supply ripple			100	mV ac pk-pk
Power Supply current (350R Bridge)		45	60	mA
Power @ 10v (350R Bridge)		450		mW
Environmental				
Output Data terminal	CAN 2.0B			
Data transmission rate	20K	-	1M	bps
Output cable length (speed dependant)			1000	m
Operating temperature range	-40		+85	C
Storage temperature	-40		+85	C
Humidity	0		95	%RH
PCB Dimensions DSC	87.4 x 20 x 8.5mm			
PCB Dimensions DCell	Diameter 20mm, Height 10mm			

Notes.

1. From original offset at any time
2. 1st Year
3. Dependent on cable type and bit rate

The DSC digital output is an open collector transistor rated at 100mA @ 40v

Technical Specifications DSC/DCELL Industrial Stability

DSC Conditioner is nominally set for 2.5mV/V sensitivity

Parameter	Min	Typical	Max	Units
Strain Gauge Excitation System	4 Wire			
Strain Gauge Excitation Voltage	4.5	5	5.25	VDC
Strain Gauge Drive Capability	320	-	5000	Ohms
Strain Gauge Sensitivity	-3	2.5	3	mV/V
Offset Temperature Stability		5	10	ppm/C
Gain Temperature Stability		30	50	ppm/C
Offset Stability with Time		35	160	ppm of FR (1)
Gain Stability with Time			300	ppm of FR (2)
Non Linearity before Linearization		5	25	ppm of FR
Internal Resolution		16 Million		Counts/divs
Resolution @ 1Hz readings (Noise stable) over 100s		66,000		Counts/divs
Resolution @ 10Hz readings (Noise stable) over 100s		40,000		Counts/divs
Resolution @ 100Hz readings (Noise stable) over 100s		10,000		Counts/divs
Signal Filter	Dynamic recursive type user programmable			
Optional Temperature Resolution				
Temperature Measurement Resolution		0.0625		Deg C
Temperature Measurement Accuracy (-10 to 85)		0.5		Deg C
Temperature Measurement Accuracy (-55 to 125)		2.0		Deg C
Temperature update Speed		5		Seconds
Electrical				
Power Supply voltage	5.6	12	18	V dc
Power Supply ripple			100	mV ac pk-pk
Power Supply current (350R Bridge)		45	60	mA
Power @ 10v (350R Bridge)		450		mW
Environmental				
Output Data terminal				
Data transmission rate	20K	-	1M	bps
Output cable length (speed dependant) Note 3			1000	m
Operating temperature range	-40		+85	C
Storage temperature	-40		+85	C
Humidity	0		95	%RH
PCB Dimensions DSC	87.4 x 20 x 8.5mm			
PCB Dimensions DCell	Diameter 20mm, Height 10mm			

Notes.

1. From original offset at any time
2. 1st Year
3. Dependent on cable type and bit rate

The DSC digital output is an open collector transistor rated at 100mA @ 40v

Mechanical Specification for DSC

Note: Viewed from top-side (CAN/label as photo on front cover of manual)

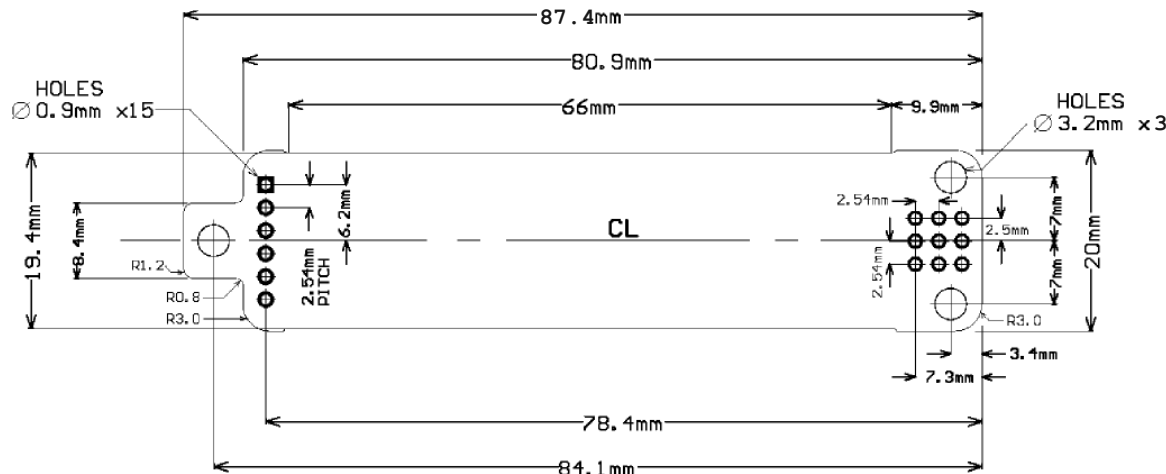

Mechanical Specification for DCell

DCell : Diameter 20mm, Height 10mm and has an 2mm mounting hole to accept M2 screw or American equivalent #0-80. Important Note: DO NOT USE #2 screw size.

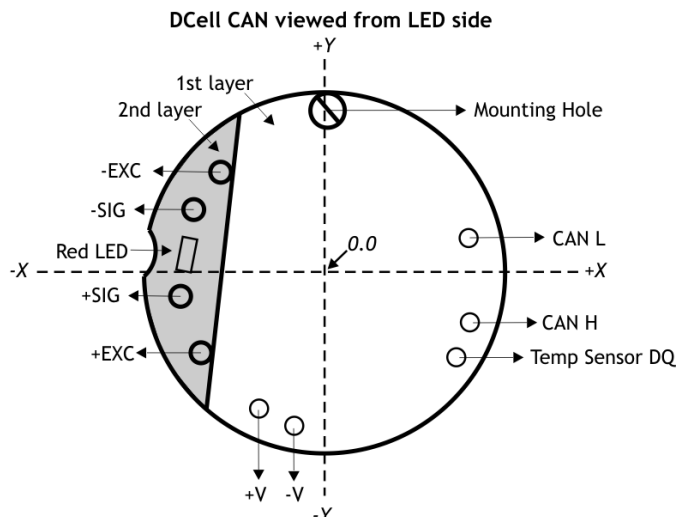

Hole centre positions taken from pcb centre.
All dimensions are in mm.

	x	y	Hole diameter
Mounting hole	0.0	8.1	2.0
-V	-3.2	-7.9	1.0
+V	-5.4	-6.6	1.0
CAN L	8.0	1.7	1.0
CAN H	8.2	-3.0	1.0
Temp sensor DQ	7.1	-5.0	1.0
+EXC	-7.6	-4.9	0.7
+SIG	-8.9	-1.4	0.7
-SIG	-8.1	4.0	0.7
-EXC	-6.4	6.3	0.7

CE Approvals

European EMC Directive

2004/108/EC

BS EN 61326-1:2006

BS EN 61326-2-3:2006



© In the interests of continued product development, Mantracourt Electronics Limited reserves the right to alter product specifications without prior notice.

Designed and Manufactured In the UK

Code No 517-174

Issue 2.8

14.05.12