

# The Garador Range Spares Catalogue

**April 2021** Up & Over Doors, Side-Hinged Doors and Operators

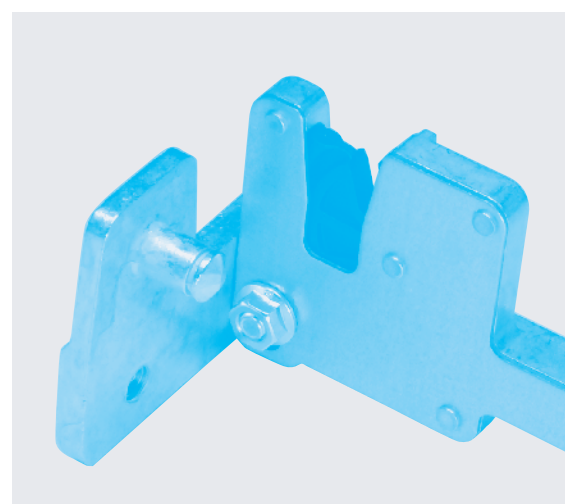
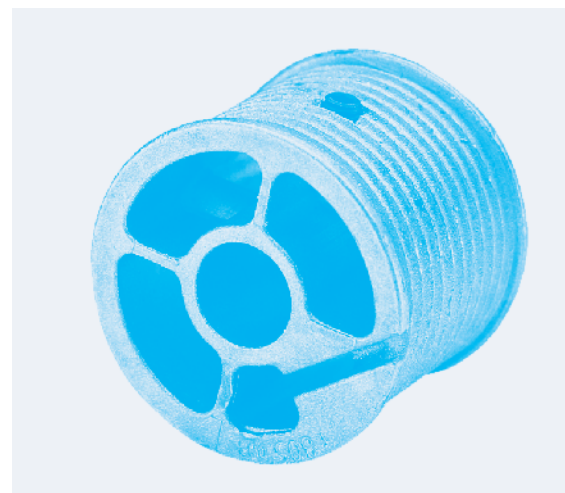

# General Information

All prices are quoted in £ Sterling, ex-works and exclusive of VAT.

All orders for spares will be subject to a minimum P&P charge, please check cost when ordering. All items are listed and priced as single items unless specified.

Please ensure that you order the correct component for your specific door, parts ordered incorrectly will be subject to a restocking charge if being returned. For handing of component, the door should be viewed from the inside, looking at the back of the panel. Please contact Garador on 01935 443722 if you need assistance in identifying the correct part.

Since the company's policy is one of continuous improvement of its products, we reserve the right to make any alterations in design, manufacture or price.

All business is governed by the Company's Standard Conditions and this document does not form any part of any contract with the company and statements contained in it should not be construed as representations or warranties.



For more information please visit  
[www.garador.co.uk](http://www.garador.co.uk)





# Contents

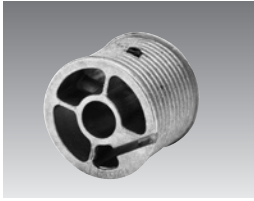
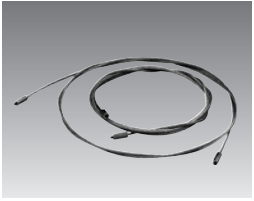
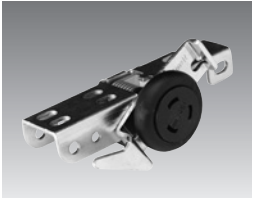

<b>Up &amp; Over Doors (2002 - current)</b>	<b>4</b>
Canopy Doors	4
Retractable Doors	6
Retractable Plus Doors	8
Handles, Lock Assembly and Keys	11
Weather seal components	13
<b>Up &amp; Over Doors (Pre 2002)</b>	<b>14</b>
Pre-2002 Spring Ref No. Conversion Chart	14
Mark 3C Accessories for Overhead Spring Box Pre 1999 (canopy)	20
Accessories for Mark 4 / F-Type Doors (canopy)	25
Accessories for doors with C Type Side Extension Springs 1999 - 2002 (canopy)	30
Single and Double Retractable Gear Components	35
Double Canopy Doors	36
Handles, Lock Assemblies and Keys	39
<b>Garage Side Doors (2002 - current)</b>	<b>40</b>
<b>Sectional Garage Doors (2002 - current)</b>	<b>41</b>
Springs and Brackets	41
Cones and Drums	44
Tension Spring Assembly	45
Torsion Spring Assembly	46
Lifting Cables	47
Frame Fitting Packs	48
Seals and Profiles	49
<b>Electric Operators</b>	<b>50</b>
GaraMatic Operators	50
EuroPro	55
<b>Consumables</b>	<b>56</b>
Bulbs and Batteries	56
Touch Up Paint	57
<b>Warranty</b>	<b>58</b>

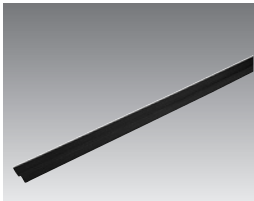
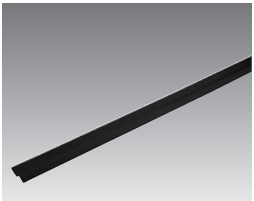
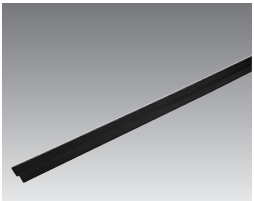
# Canopy Doors

				
Article	Cable Drum 2002 - current.	Canopy Cables Sold in pairs. 2002 - current.	Safety Latch and Roller For canopy doors. 2002 - current.	Door Top Weatherstrip 2002 - current.
Ref. No.	(LH) 57, (RH) 58	45	(LH) 127, (RH) 128	110
Price £	14.00	28.00 (per pair)	29.00	18.00

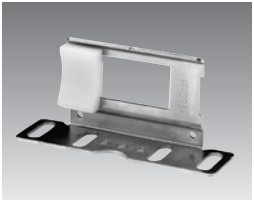
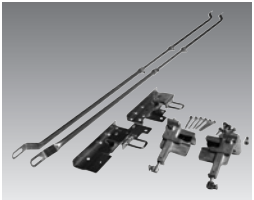
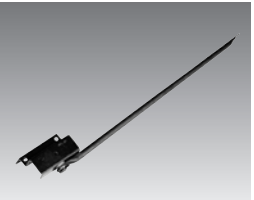
				
Article	Bottom Weatherstrip for Timber Frame Cut to length. 2002 - current.	Rubbing Strip for Steel Frame Cut to length. 2002 - current.	Bottom Weather Strip for Steel Frame Specify door height when ordering. 2002 - current.	Spring Assembly Specify door width when ordering. 2002 - current.
Ref. No.	111	109	108	1223 (state size on order)
Price £	18.00	19.00	19.00	96.00

				
Article	Door Latch Assembly 2002 - current.	Door Latch Keeper 2002 - current.	Additional Lock Kit For canopy doors. 2003 - current.	Canopy Link Arm Assembly Steel/Timber (2002 - current) & GRP (2006 - current).
Ref. No.	122	126	1768	145
Price £	13.00	13.00	61.00	48.00



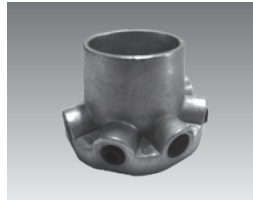
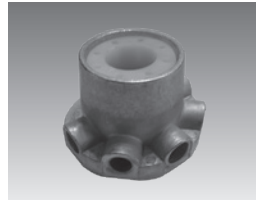

			
Article	Canopy Link Arm Assembly GRP 2002 - 2006.	Canopy Track Assembly Includes cable and roller. Sold in pairs. 2002 - current.	Canopy Tensioning Bars Sold in pairs.
Ref. No.	187	160161	1222
Price £	48.00	124.00	20.00

## Canopy Doors







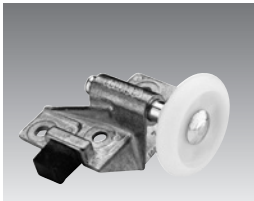
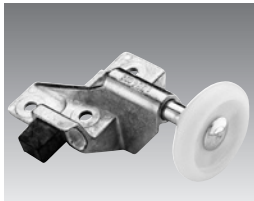
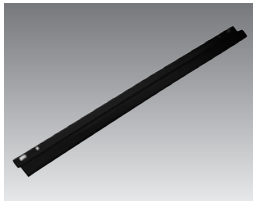
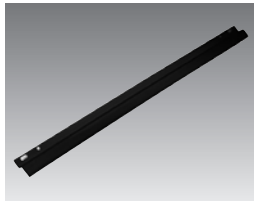

Article	Left Spring Cone	Right Spring Cone
Ref. No.	59	60
Price £	16.00	16.00

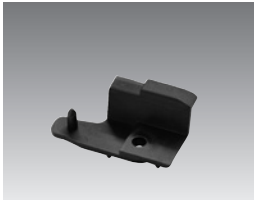
# Retractable Doors

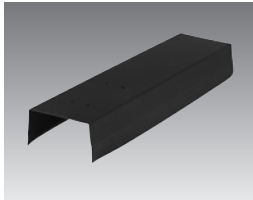
				
Article	Retractable Spring Assembly 001 2002 - current.	Retractable Spring Assembly 002 2002 - current.	Retractable Spring Assembly 003 2002 - current.	Retractable Spring Assembly 004 2002 - current.
Ref. No.	52	53	54	1226
Price £	47.00 (each)	47.00 (each)	47.00 (each)	47.00 (each)

				
Article	Roller Bracket Assembly For all framed retractable doors. 2002 - 2003.	Roller Bracket Assembly For all framed retractable doors. 2003 - current.	Retractable Top Weatherstrip For 6'6" high door.	Retractable Top Weatherstrip For 7'0" high door.
Ref. No.	(LH) 123, (RH) 124	(LH) 120, (RH) 121	104	105
Price £	38.00	29.00	18.00	18.00

				
Article	Pivot Block (Panel) For retractable doors. 2004 - current.	Pivot Block (Frame) 2004 - current.	Finger Trap Protection For retractable doors. 2004 - current.	Retractable Link Arm Assembly for steel frame 6'4" 2002 - current.
Ref. No.	(LH) 251, (RH) 252	(LH) 88, (RH) 89	100	(LH) 4668, (RH) 4669
Price £	16.00	14.00	15.00	39.00

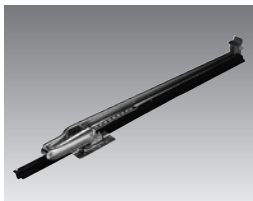
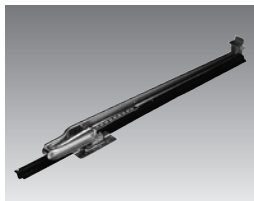
				
Article	Retractable Link Arm Assembly for steel frame 6'6" 2002 - current.	Retractable Link Arm Assembly for steel frame 7'0" 2002 - current.	Retractable Link Arm Assembly for timber frame 6'4" 2002 - current.	Retractable Link Arm Assembly for timber frame 6'6" 2002 - current.
Ref. No.	(LH) 4670, (RH) 4671	(LH) 4672, (RH) 4673	(LH) 4834, (RH) 4835	(LH) 4836, (RH) 4837
Price £	39.00	39.00	49.00	49.00

## Retractable Doors

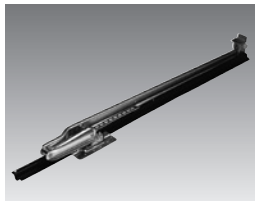
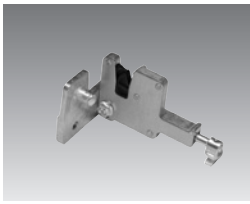
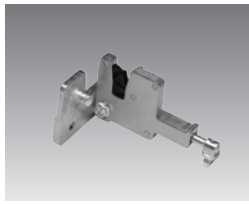
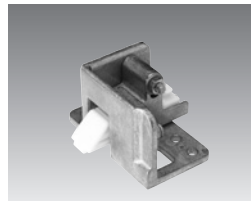

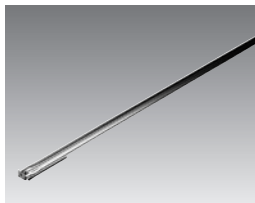
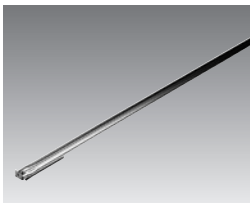
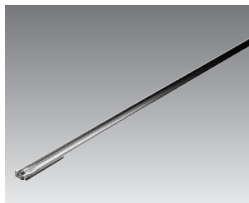
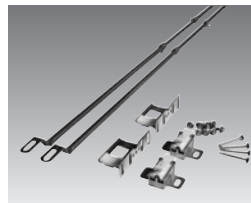
				
Article	<b>Retractable Link Arm Assembly</b> For timber frame. 7'0" 2002 - current.	<b>Retractable Latch</b> For steel doors. 2005 - current.	<b>Retractable Latch</b> Gold in colour. For timber doors (2005 - current) & GRP doors (2006 - current).	<b>Retractable Latch</b> For steel doors (2002 - 2003) and GRP Doors (2002 - 2006).
Ref. No.	(LH) 4838, (RH) 4839	(LH) 2790, (RH) 2791	(LH) 3076, (RH) 3077	(LH) 180, (RH) 181
Price £	49.00	31.00	31.00	31.00

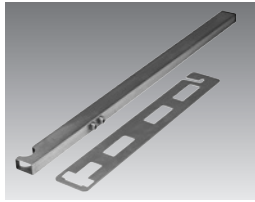
				
Article	<b>Retractable Track Assembly</b> Up to 10'0" wide - 6'4" high. Unframed doors only. 2002 - current.	<b>Retractable Track Assembly</b> Up to 10'0" wide - 6'6" high. Unframed doors only. 2002 - current.	<b>Retractable Track Assembly</b> Up to 10'0" wide - 7'0" high. Unframed doors only. 2002 - current.	<b>Additional Lock Kit</b> For retractable doors. 2003 - current.
Ref. No.	(LH) 269, (RH) 270	(LH) 271, (RH) 272	(LH) 273, (RH) 274	1769
Price £	47.00	47.00	47.00	61.00

	
Article	<b>Tensioning Tool</b> For retractable doors. 2002 - current.
Ref. No.	1909
Price £	87.00

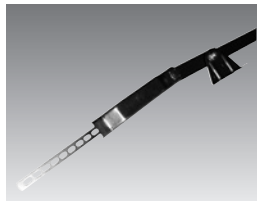
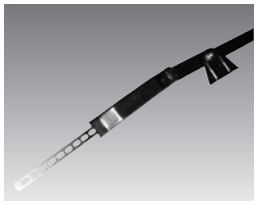
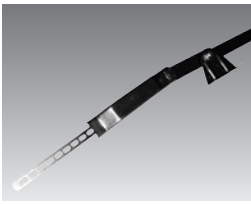
## Retractable Plus Doors



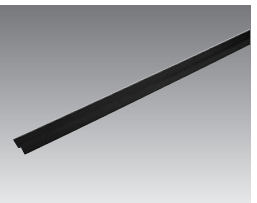

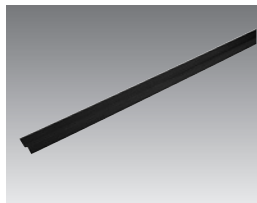
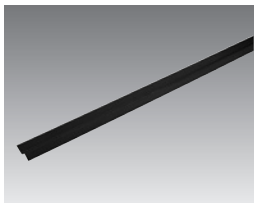
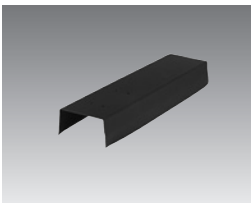
			
Article	<b>Retractable Plus Link Arm Assembly</b> For timber and steel frame. 6'4" Weather strip not included.	<b>Retractable Plus Link Arm Assembly</b> For timber and steel frame. 6'6" Weather strip not included.	<b>Retractable Plus Link Arm Assembly</b> For timber and steel frame. 7'0"
Ref. No.	2617	2618	2619
Price £	47.00	47.00	51.00

				
Article	<b>Top Weather Strip</b> For 6'4" retractable plus doors, timber and steel frame. 2005 - current.	<b>Top Weather Strip</b> For 6'6" retractable plus doors, timber and steel frame. 2005 - current.	<b>Top Weather Strip</b> For 7'0" retractable plus doors, timber and steel frame. 2005 - current.	<b>Bottom Weather Strip</b> For 6'4" retractable plus doors, timber and steel frame. 2005 - current.
Ref. No.	2677	1709	1710	2675
Price £	18.00	18.00	18.00	20.00

			
Article	<b>Bottom Weather Strip</b> For 6'6" retractable plus doors, timber and steel frame. 2005 - current.	<b>Bottom Weather Strip</b> For 7'0" retractable plus doors, timber and steel frame. 2005 - current.	<b>Finger Trap Protection</b> For retractable plus doors. 2005 - current.
Ref. No.	1699	1700	1844
Price £	20.00	20.00	15.00



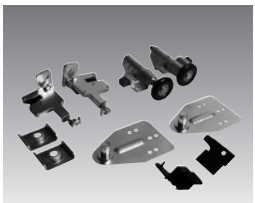
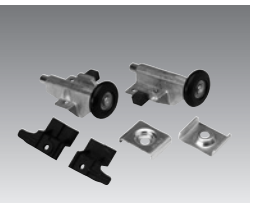
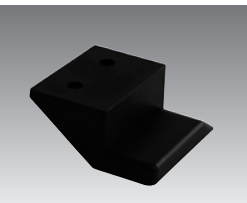

# Double Retractable Doors

				
Article	Double Door Spring Assembly 4er 025 2004 - current.	Double Door Spring Assembly 4er 032 2004 - current.	Double Door Spring Assembly 023 2004 - current.	Double Door Spring Assembly 615 2004 - current.
Ref. No.	1946	1945	4346	1943
Price £	61.00 (each)	61.00 (each)	61.00 (each)	61.00 (each)

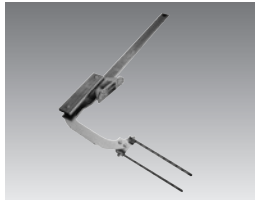
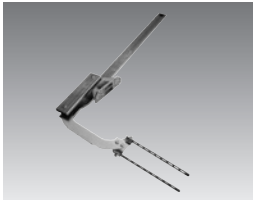
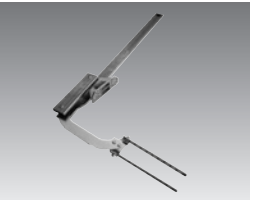
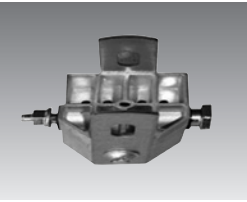
				
Article	Double Door Spring Assembly 621 2004 - current.	Double Door Latch and Roller Pack	Double Door Top Roller and Bracket Pack 2002 - current.	Frame Pivot Block For double doors.
Ref. No.	1944	4333	1940	(LH) 4272, (RH) 4273
Price £	61.00 (each)	124.00	68.00	14.00

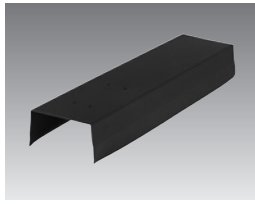
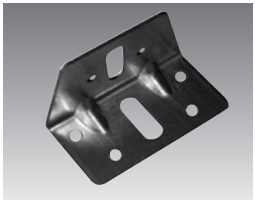
				
Article	Link Arm 1931 mm 6'4" 2009 - current.	Link Arm 1980 mm 6'6" 2009 - current.	Link Arm 2036 mm 7'0" 2009 - current.	Spring Coupling Bracket For double doors.
Ref. No.	(LH) 6013, (RH) 6014	(LH) 4278, (RH) 4279	(LH) 4280, (RH) 4281	4379
Price £	109.00	109.00	109.00	52.00

				
Article	Finger Trap Protection For double doors.	Track/Wall Bracket For double doors.	N800 Double Door Latch Keeper For steel frames.	N800 Double Door Latch Keeper For timber frames.
Ref. No.	4285	4284	(LH) 4275, (RH) 4276	(LH) 4306, (RH) 4307
Price £	15.00	18.00	62.00	62.00

## Double Retractable Doors

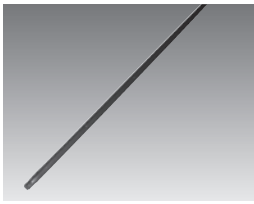
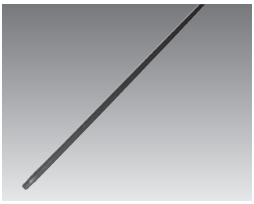
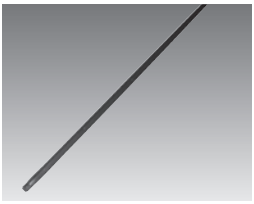
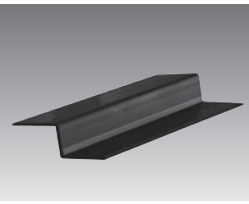
				
Article	N800 Double Door Track 1980 mm L/R.	N800 Double Door Track 2139 mm L/R.	N800 Double Door Track 1931 mm L/R.	Bottom Frame Weatherstrip 1980/2136 For double doors 6'6" high.
Ref. No.	4372	4373	6015	4310
Price £	66.00	66.00	66.00	21.00

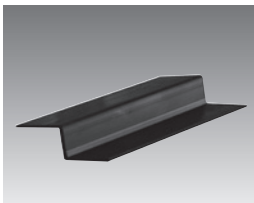
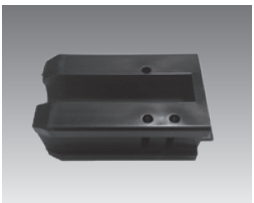
		
Article	Bottom Frame Weatherstrip 1980/2136 For double doors 7'0 high.	Retractable Connecting Block
Ref. No.	4311	81
Price £	21.00	13.00





# Handles, Lock Assembly and Keys

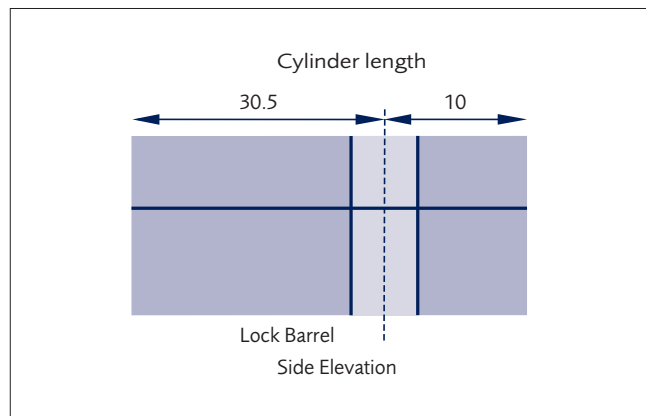



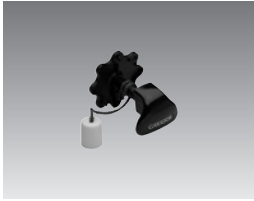

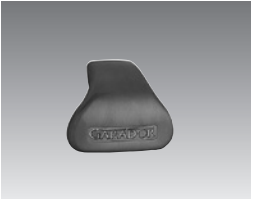
	Doortype	Cylinder Length	Ref. No.	Price £
Lock Body with Cylinders (2003 - Current)	Suitable for all Carlton, Horizon, Salisbury, Chevron and all double steel doors	30.5 + 10	204	40.00
Lock Body with Cylinders (2003 - Current)	Suitable for all Georgian, Beaumont, Cathedral, Sherwood and Wentwood doors	35 + 10	202	40.00
Lock Body with Cylinders (2003 - Current)	Suitable for all Tudor, Seymour, Wolsey, Shaftsbury and single GRP doors	40 + 10	203	48.00
Lock Body with Cylinders (2002 - Current)	Suitable for all GRP and timber doors	50.5 + 10	1796	48.00
Lock Body with Cylinders (2003 - Current)	Suitable for all Sandhurst, Chevron Cedar, Kingsbury, Barrington, Bosworth and all double GRP doors	55.5 + 10	2078	48.00

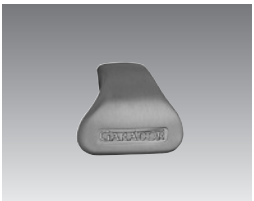

# Handles, Lock Assembly and Keys

				
Article	<b>Standard Black Handle</b> All steel doors. 2002 - current.	<b>Standard Black Handle</b> (adjustable and fascia) All timber and GRP doors. 2002 - current.	<b>Brass Effect Handle</b> For up & over doors. 2002 - current.	<b>Chrome Effect Handle</b> For up & over doors. 2002 - current.
Ref. No.	550	7258	5072	5073
Price £	16.00	24.00	34.00	34.00

				
Article	<b>White Effect Handle</b> For up & over doors. 2002 - current.	<b>Brushed Steel Effect Handle</b> For up & over doors. 2002 - current.	<b>Brass Fascia Plate</b> For up & over doors. 2002 - current.	<b>Chrome Fascia Plate</b> For up & over doors. 2002 - current.
Ref. No.	5071	6460	3161	3162
Price £	34.00	34.00	10.00	10.00

		
Article	<b>White Fascia Plate</b> For up & over doors. 2002 - current.	<b>Brushed Steel Fascia Plate</b> For up & over doors. 2002 - current.
Ref. No.	3160	7648
Price £	10.00	10.00

## Weather seal components

				
<b>Article</b>	<b>Bottom Weather Seal</b> Length 2405 mm (15 mm profile).	<b>Bottom Weather Seal</b> Length 3000 mm (15 mm profile).	<b>Glue Down Rubber Weatherseal</b> Approx 2.5 m length.	<b>Brushstrip</b> Approx 2.5m length.
<b>Ref. No.</b>	7841	7842	1837	1196
<b>Price £</b>	41.00	46.00	58.00	36.00

# Pre-2002 Spring Ref No. Conversion Chart

C Type overhead spring box fitted to a timber frame - Ref. No.	Spring No.
4739	S1703001-3-1
4740	S1703001-3-2
4741	S1703001-3-3
4742	S1703001-3-4
4743	S1703001-3-6
4744	S1703001-3-8
4745	S1703001-3-9
4746	S1703001-3-10
4747	S1703001-3-11

C Type side extension spring fitted to a timber frame - Ref. No.	Spring No.
4733	G230-18-1
4734	G230-18-2
4735	G230-18-3
4736	G230-18-4
4737	G230-18-5
4738	G230-18-6

F type & MK 4 spring - Ref. No.	Spring No.
2149	S4-401
2150	S4-402
2151	S4-404
2152	S4-405
2153	S4-407

R, FR & DR spring - Ref. No.	Spring No.
4763	108-901
4764	108-903
4765	108-905
4766	108-907
4767	108-909
4768	108-911
4769	108-913
4770	108-915
4774	108-921
4775	108-923
4776	108-925
4777	108-927

DC Type spring - Ref. No.	Spring No.
4748	108-701
4749	108-703
4750	108-705
4751	108-707
4752	108-709
4753	108-711
4754	108-713
4755	108-721
4756	108-723
4757	108-725
4758	108-727

# Canopy Doors

## Mark 3C Springs Suitable for Overhead Spring Box fitted to a timber frame - Steel Panel Doors

Used on all Canopy doors pre 1999. Springs priced and supplied individually. However, it is always recommended that both springs are replaced at the same time.



For price, please see page 20

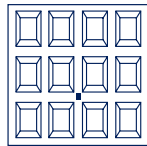

Georgian/Georgian Elite

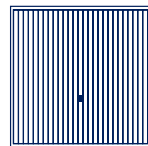

Carlton/Carlton Elite



Salisbury/Salisbury Elite

	Spring box number	Spring box spring	No. of bands & Colour	Spring box number	Spring box spring	No. of bands & Colour	Spring box number	Spring box spring	No. of bands & Colour
6'6"x6'3"	-	-	-	PN58	4739	1 x Silver	-	-	-
6'6"x6'6"	PN167	4743	None	PN58	4739	1 x Silver	-	-	-
6'6"x7'0"	PN167	4743	None	PN58	4739	1 x Silver	-	-	-
7'0"x6'3"	-	-	-	N/A	N/A	N/A	-	-	-
7'0"x6'6"	PN57/1	4740	1 x Blue	PN58	4739	1 x Silver	PN55/2	4742	3 x Blue
7'0"x7'0"	PN150	4746	None	PN55/2	4742	3 x Blue	PN155	4747	1 x Orange
7'3 1/2"x6'4"	-	-	-	PN57/1	4740	1 x Blue	-	-	-
7'5"x6'3"	-	-	-	-	-	-	-	-	-
7'5"x6'6"	PN55/2	4742	3 x Blue	PN57/1	4740	1 x Blue	PN155	4747	1 x Orange
7'5"x7'0"	PN108	4745	2 x Orange	PN150	4746	None	PN108	4745	2 x Orange
7'6"x6'6"	PN55/2	4742	3 x Blue	PN57/1	4740	1 x Blue	PN155	4747	1 x Orange
7'6"x7'0"	N/A	N/A	N/A	N/A	N/A	N/A	N/A	N/A	N/A
7'8 1/2"x6'3"	-	-	-	N/A	N/A	N/A	-	-	-
7'8 1/2"x6'6 3/4"	PN150	4746	None	PN55/2	4742	3 x Blue	-	-	-
7'8 1/2"x6'11 3/4"	N/A	N/A	N/A	PN155	4747	1 x Orange	-	-	-
8'0"x6'3"	-	-	-	N/A	N/A	N/A	-	-	-
8'0"x6'6"	PN150	4746	None	PN55/2	4742	3 x Blue	PN150	4746	None
8'0"x7'0"	PN108	4745	2 x Orange	PN155	4747	1 x Orange	PN155	4747	1 x Orange
8'2 1/2"x6'3"	-	-	-	N/A	N/A	N/A	-	-	-
8'2 1/2"x6'6 3/4"	-	-	-	PN150	4746	None	-	-	-
8'2 1/2"x6'11 3/4"	-	-	-	PN155	4747	1 x Orange	-	-	-



For price, please see page 20

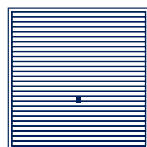

Horizon/Horizon Elite

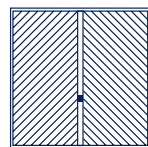

Chevron/Chevron Elite

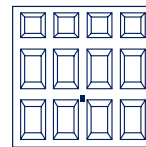

Beaumont/Beaumont Elite

	Spring box number	Spring box spring	No. of bands & Colour	Spring box number	Spring box spring	No. of bands & Colour	Spring box number	Spring box spring	No. of bands & Colour
6'6"x6'3"	PN58	4739	1 x Silver	-	-	-	-	-	-
6'6"x6'6"	PN58	4739	1 x Silver	PN167	4743	None	-	-	-
6'6"x7'0"	PN58	4739	1 x Silver	PN167	4743	None	-	-	-
7'0"x6'3"	N/A	N/A	N/A	-	-	-	-	-	-
7'0"x6'6"	PN58	4739	1 x Silver	PN57/1	4740	1 x Blue	4742	3 x Blue	
7'0"x7'0"	PN57/1	4740	1 x Blue	PN55/2	4742	3 x Blue	4747	1 x Orange	
7'3 1/2"x6'4"	PN56/1	4741	2 x Blue	-	-	-	-	-	-
7'5"x6'3"	N/A	N/A	N/A	-	-	-	-	-	-
7'5"x6'6"	PN56/1	4741	2 x Blue	PN55/2	4742	3 x Blue	4742	3 x Blue	

# Canopy Doors

7'5"x7'0"	PN55/2	4742	3 x Blue	PN155	4747	1 x Orange	-	-	-
7'6"x6'6"	PN57/1	4740	1 x Blue	PN55/2	4742	3 x Blue	-	-	-
7'6"x7'0"	N/A	N/A	N/A	N/A	N/A	N/A		4747	1 x Orange
7'81/2"x6'3"	N/A	N/A	N/A	-	-	-	-	-	-
7'81/2"x6'63/4"	PN115	4744	2 x Silver	PN55/2	4742	3 x Blue	-	-	-
7'81/2"x6'113/4"	PN55/2	4742	3 x Blue	PN155	4747	1 x Orange	-	-	-
8'0"x6'3"	N/A	N/A	N/A	-	-	-	-	-	-
8'0"x6'6"	PN115	4744	2 x Silver	-	-	-	-	-	-
8'0"x7'0"	PN150	4746	None	-	-	-	-	-	-
8'21/2"x6'3"	N/A	N/A	N/A	-	-	-	-	-	-
8'21/2"x6'63/4"	PN55/2	4742	3 x Blue	-	-	-	-	-	-
8'21/2"x6'113/4"	PN155	4747	1 x Orange	-	-	-	-	-	-



For price, please see page 20

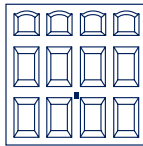

Cathedral/Cathedral Elite

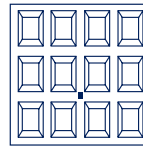

Parade White/Brown

	Spring box number	Spring box spring	No. of bands & Colour	Spring box number	Spring box spring	No. of bands & Colour
6'6"x6'3"	-	-	-	-	-	-
6'6"x6'6"	-	-	-	PN167	4743	None
6'6"x7'0"	-	-	-	-	-	-
7'0"x6'3"	-	-	-	-	-	-
7'0"x6'6"	PN55/2	4742	3 x Blue	PN57/1	4740	1 x Blue
7'0"x7'0"	PN155	4747	1 x Orange	PN155	4747	1 x Orange
7'31/2"x6'4"	-	-	-	-	-	-
7'5"x6'3"	-	-	-	-	-	-
7'5"x6'6"	PN55/2	4742	3 x Blue	PN155	4747	1 x Orange
7'5"x7'0"	-	-	-	PN155	4747	1 x Orange
7'6"x6'6"	-	-	-	N/A	N/A	N/A
7'6"x7'0"	PN155	4747	1 x Orange	N/A	N/A	N/A
7'81/2"x6'3"	-	-	-	-	-	-
7'81/2"x6'63/4"	-	-	-	-	-	-
7'81/2"x6'113/4"	-	-	-	-	-	-
8'0"x6'3"	-	-	-	-	-	-
8'0"x6'6"	-	-	-	PN155	4747	1 x Orange
8'0"x7'0"	-	-	-	PN108	4745	2 x Orange
8'21/2"x6'3"	-	-	-	-	-	-
8'21/2"x6'63/4"	-	-	-	-	-	-
8'21/2"x6'113/4"	-	-	-	-	-	-



# Canopy Doors

**Mark 3C Springs Suitable for Overhead Spring Box fitted to a timber frame - GRP Premier Panel Doors**  
 Used on all Canopy doors pre 1999. Springs priced and supplied individually. However, it is always recommended that both springs are replaced at the same time.



For price, please see page 20

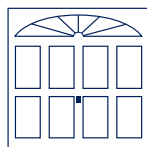

Stamford

Spring box number	Spring box spring	No. of bands & Colour
N/A	N/A	N/A

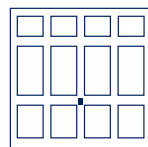

Arden

Spring box number	Spring box spring	No. of bands & Colour
PN55/2	4742	3 x Blue

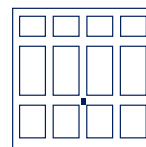

Kenmore

Spring box number	Spring box spring	No. of bands & Colour
PN55/2	4742	3 x Blue

7'0"x6'6"	N/A	N/A	N/A	PN55/2	4742	3 x Blue	PN55/2	4742	3 x Blue
7'0"x7'0"	N/A	N/A	N/A	PN55/2	4742	3 x Blue	PN55/2	4742	3 x Blue
7'5"x6'6"	N/A	N/A	N/A	PN155	4747	1 x Orange	PN155	4747	1 x Orange
7'6"x7'0"	N/A	N/A	N/A	PN155	4747	1 x Orange	PN155	4747	1 x Orange



For price, please see page 20

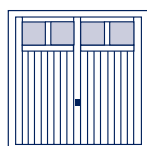

Derwent

Spring box number	Spring box spring	No. of bands & Colour
N/A	N/A	N/A

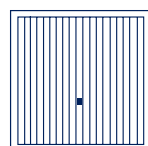

Swinton

Spring box number	Spring box spring	No. of bands & Colour
PN55/2	4742	3 x Blue

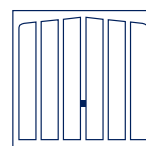

Clifton

Spring box number	Spring box spring	No. of bands & Colour
PN55/2	4742	3 x Blue

7'0"x6'6"	N/A	N/A	N/A	PN55/2	4742	3 x Blue	PN55/2	4742	3 x Blue
7'0"x7'0"	N/A	N/A	N/A	PN55/2	4742	3 x Blue	PN55/2	4742	3 x Blue
7'5"x6'6"	N/A	N/A	N/A	PN155	4747	1 x Orange	PN155	4747	1 x Orange
7'6"x7'0"	N/A	N/A	N/A	PN155	4747	1 x Orange	PN155	4747	1 x Orange



For price, please see page 20

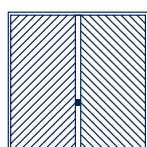

Oakham

Spring box number	Spring box spring	No. of bands & Colour
PN55/2	4742	3 x Blue

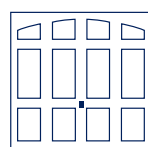

Woburn

Spring box number	Spring box spring	No. of bands & Colour
N/A	N/A	N/A

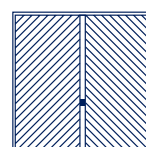

Wentwood

Spring box number	Spring box spring	No. of bands & Colour
PN55/2	4742	3 x Blue

7'0"x6'6"	PN55/2	4742	3 x Blue	N/A	N/A	N/A	PN55/2	4742	3 x Blue
7'0"x7'0"	PN55/2	4742	3 x Blue	N/A	N/A	N/A	PN155	4747	1 x Orange
7'5"x6'6"	PN155	4747	1 x Orange	N/A	N/A	N/A	PN55/2	4742	3 x Blue
7'6"x7'0"	PN155	4747	1 x Orange	N/A	N/A	N/A	PN155	4747	1 x Orange

# Canopy Doors

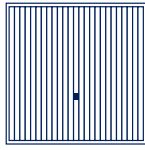
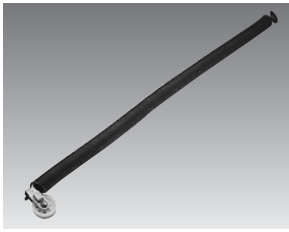

Sherwood

For price, please see page 20

	Spring box number	Spring box spring	No. of bands & Colour
7'0"x6'6"	PN55/2	4742	3 x Blue
7'0"x7'0"	PN155	4747	1 x Orange
7'5"x6'6"	PN55/2	4742	3 x Blue
7'6"x7'0"	PN155	4747	1 x Orange

# Canopy Doors

## Mark 3C Springs Suitable for Overhead Spring Box fitted to a timber frame - Timber Panel Doors

Used on all Canopy doors pre 1999. Springs priced and supplied individually. However, it is always recommended that both springs are replaced at the same time.



For price, please see page 20

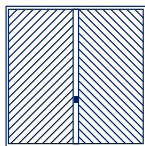

Chevron Cedar

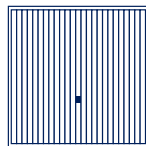

Vertical Cedar

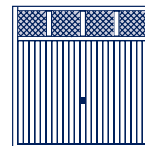

Sandhurst

	Spring box number	Spring box spring	No. of bands & Colour	Spring box number	Spring box spring	No. of bands & Colour	Spring box number	Spring box spring	No. of bands & Colour
7'0"x6'6"	PN57/1	4740	1 x Blue	PN57/1	4740	1 x Blue	-	-	-
7'0"x7'0"	PN55/2	4742	3 x Blue	PN55/2	4742	3 x Blue	PN55/2	4742	3 x Blue
7'5"x6'6"	PN55/2	4742	3 x Blue	PN57/1	4740	1 x Blue	PN55/2	4742	3 x Blue
7'5"x7'0"	PN55/2	4742	3 x Blue	PN150	4746	None	PN55/2	4742	3 x Blue
7'6"x6'6"	PN55/2	4742	3 x Blue	PN55/2	4742	3 x Blue	PN55/2	4742	3 x Blue
7'6"x7'0"	-	-	-	PN55/2	4742	3 x Blue	-	-	-



For price, please see page 20

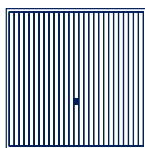

Cavendish

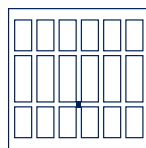

Wolsey

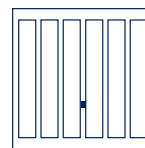

Seymour

	Spring box number	Spring box spring	No. of bands & Colour	Spring box number	Spring box spring	No. of bands & Colour	Spring box number	Spring box spring	No. of bands & Colour
7'0"x6'6"	-	-	-	PN55/2	4742	3 x Blue	PN55/2	4742	3 x Blue
7'0"x7'0"	PN55/2	4742	3 x Blue	PN155	4747	1 x Orange	PN155	4747	1 x Orange
7'5"x6'6"	PN55/2	4742	3 x Blue	PN55/2	4742	3 x Blue	PN55/2	4742	3 x Blue
7'5"x7'0"	PN55/2	4742	3 x Blue	PN155	4747	1 x Orange	PN155	4747	1 x Orange
7'6"x6'6"	PN55/2	4742	3 x Blue	PN55/2	4742	3 x Blue	PN55/2	4742	3 x Blue
7'6"x7'0"	-	-	-	PN55/2	4742	3 x Blue	PN55/2	4742	3 x Blue



For price, please see page 20

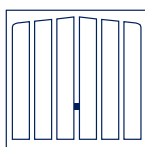

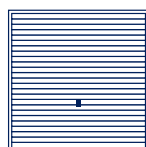

Tudor









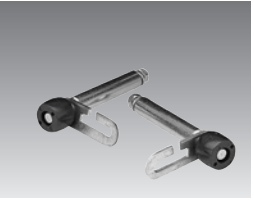

Horizontal Cedar



	Spring box number	Spring box spring	No. of bands & Colour	Spring box number	Spring box spring	No. of bands & Colour
7'0"x6'6"	PN55/2	4742	3 x Blue	PN57/1	4740	1 x Blue
7'0"x7'0"	PN155	4747	1 x Orange	PN55/2	4742	3 x Blue
7'5"x6'6"	PN55/2	4742	3 x Blue	PN57/1	4740	1 x Blue
7'5"x7'0"	PN155	4747	1 x Orange	PN150	4746	None
7'6"x6'6"	PN55/2	4742	3 x Blue	-	-	-
7'6"x7'0"	PN55/2	4742	3 x Blue	-	-	-

## Mark 3C Accessories for Overhead Spring Box Pre 1999 (canopy)

				
Article	Canopy Type Cables (Overhead Spring) 6'6" (1980 mm) wide door. Sold in pairs.	Canopy Type Cables (Overhead Spring) 7'0" (2135 mm) to 8'2 1/2" (2500 mm) wide door. Sold in pairs.	Canopy Type Cables (Overhead Spring) Belgravia doors only. Sold in pairs. Pre 1999.	Rollers and spindles (pair) Overall length 94 mm. MK 3 C type only.
Ref. No.	1154	1155	1156	1158
Price £	31.00	31.00	31.00	41.00

				
Article	Rollers and spindles (pair) Overall length 81 mm. C type only.	C Type Overhead Spring For Box PN55/2. Pre 1999.	C Type Overhead Spring For Box PN56/1. Pre 1999.	C Type Overhead Spring For Box PN57/1. Pre 1999.
Ref. No.	1159	4742	4741	4740
Price £	41.00	80.00	80.00	80.00

				
Article	C Type Overhead Spring For Box PN58. Pre 1999.	C Type Overhead Spring For Box PN108. Pre 1999.	C Type Overhead Spring For Box PN115. Pre 1999.	C Type Overhead Spring For Box PN150. Pre 1999.
Ref. No.	4739	4745	4744	4746
Price £	80.00	80.00	80.00	80.00

			
Article	C Type Overhead Spring For Box PN155. Pre 1999.	C Type Overhead Spring For Box PN167. Pre 1999.	C Type Link Arm Pre 1999.
Ref. No.	4747	4743	(LH) 1202 . (RH) 1203
Price £	80.00	80.00	48.00

# Framed Canopy Doors

## Mark 4 / F-Type Springs - Steel Panel Doors

Used on all Framed Canopy doors pre 2002. For springs with flat fixing pins part 1197 is also required. Springs priced and supplied individually. However, it is always recommended that both springs are replaced at the same time.



For price, please see page 25

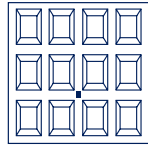

Georgian/  
Georgian Elite

Spring Type

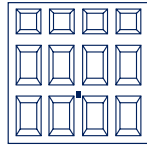

Beaumont/  
Beaumont Elite

Spring Type

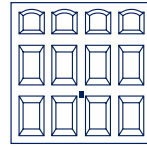

Cathedral/  
Cathedral Elite

Spring Type

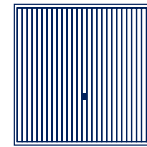

Carlton/  
Carlton Elite

Spring Type

6'6"x6'3"	-	-	-	2149
6'6"x6'6"	2150	-	-	2149
6'6"x7'0"	2151	-	-	2150
7'0"x6'3"	-	-	-	2149
7'0"x6'6"	2151	2150	2150	2149
7'0"x7'0"	2153	2152	2152	2151
7'3 1/2"x6'4"	-	-	-	2149
7'5"x6'3"	-	-	-	2150
7'5"x6'6"	2151	2151	2151	2150
7'5"x7'0"	2153	2152	2152	2151
7'6"x6'6"	2151	2152	2152	2150
7'6"x7'0"	2153	2153	2153	2152
7'8 1/2"x6'3"	-	-	-	2150
7'8 1/2"x6'6 3/4"	2152	2152	2152	2150
7'8 1/2"x6'11 3/4"	2153	2152	2152	2152
8'0"x6'3"	-	-	-	2151
8'0"x6'6"	2152	2152	2152	2151
8'0"x7'0"	2153	2153	2153	2152
8'2 1/2"x6'3"	-	-	-	2151
8'2 1/2"x6'6 3/4"	-	-	-	2151
8'2 1/2"x6'11 3/4"	-	-	-	2152

# Framed Canopy Doors



For price, please see page 25

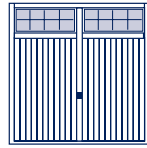

Salisbury/  
SalisburyElite

Spring Type

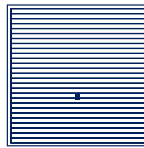

Horizon/  
Horizon Elite

Spring Type

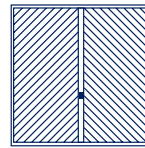

Chevron/  
Chrevron Elite

Spring Type

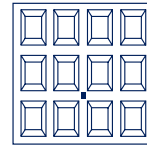

Parade  
White/Brown

Spring Type

6'6"x6'3"	-	2149	-	-
6'6"x6'6"	-	2149	2149	-
6'6"x7'0"	-	2150	2150	-
7'0"x6'3"	-	2149	-	-
7'0"x6'6"	2151	2149	2149	2151
7'0"x7'0"	2152	2150	2150	2152
7'3 1/2"x6'4"	-	2149	-	-
7'5"x6'3"	-	2149	-	-
7'5"x6'6"	2152	2149	2150	2152
7'5"x7'0"	2153	2151	2151	2151
7'6"x6'6"	2152	2150	2150	2151
7'6"x7'0"	2153	2151	2151	2152
7'8 1/2"x6'3"	-	2150	-	-
7'8 1/2"x6'6 3/4"	-	2150	2151	-
7'8 1/2"x6'11 3/4"	-	2152	2152	-
8'0"x6'3"	-	2150	-	-
8'0"x6'6"	2153	2150	-	2151
8'0"x7'0"	2153	2152	-	2152
8'2 1/2"x6'3"	-	2150	-	-
8'2 1/2"x6'6 3/4"	-	2150	-	2152
8'2 1/2"x6'11 3/4"	-	2152	-	2153

# Framed Canopy Doors

## Mark 4 / F-Type Spring - GRP Premier Panel Doors

Used on all Framed Canopy doors pre 2002. For springs with flat fixing pins part S4-6 is also required. Springs priced and supplied individually. However, it is always recommended that both springs are replaced at the same time.



For price, please see page 25

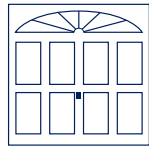

Stamford

Spring Type

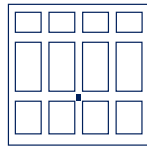

Arden

Spring Type

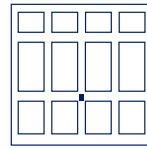

Kenmore

Spring Type

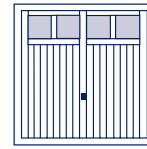

Derwent

Spring Type

7'0"x6'6"	2151	2152	2152	2152
7'0"x7'0"	2151	2152	2152	2152
7'5"x6'6"	2151	2152	2152	2152
7'6"x7'0"	2151	2152	2152	2152



For price, please see page 25

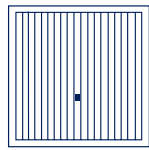

Swinton

Spring Type

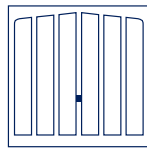

Clifton

Spring Type

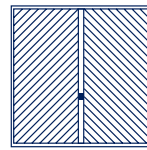

Oakham

Spring Type

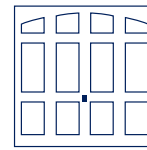

Woburn

Spring Type

7'0"x6'6"	2151	2152	2152	2152
7'0"x7'0"	2151	2152	2152	2152
7'5"x6'6"	2151	2152	2152	2152
7'6"x7'0"	2151	2152	2152	2152

# Framed Canopy Doors

## Mark 4 / F-Type Springs - Timber Panel Doors

Used on all Framed Canopy doors pre 2002. For springs with flat fixing pins part S4-6 is also required. Springs priced and supplied individually. However, it is always recommended that both springs are replaced at the same time.



For price, please see page 25

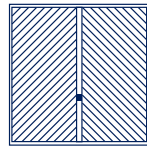

Chevron Cedar

Spring Type

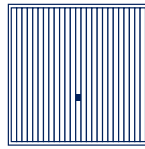

Vertical Cedar

Spring Type

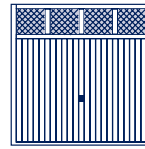

Sandhurst

Spring Type

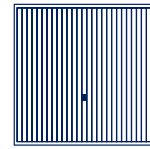

Cavendish

Spring Type

7'0"x6'6"	2150	2149	2151	2151
7'0"x7'0"	2150	2150	2152	2152
7'5"x6'6"	2150	2150	2151	2151
7'5"x7'0"	2151	2150	2152	2152
7'6"x6'6"	2150	2150	-	-
7'6"x7'0"	2151	2150	-	-



For price, please see page 25

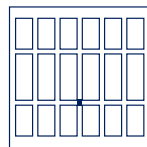

Wolsey

Spring Type

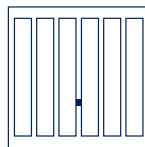

Seymour

Spring Type

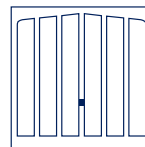

Tudor

Spring Type

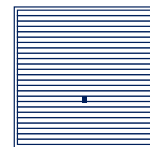





Horizontal Cedar





Spring Type

7'0"x6'6"	2150	2150	2150	2150
7'0"x7'0"	2151	2151	2151	2151
7'5"x6'6"	2151	2151	2151	2151
7'5"x7'0"	2152	2152	2152	2152
7'6"x6'6"	2151	2151	2151	-
7'6"x7'0"	2152	2152	2152	-



## Accessories for Mark 4 / F-Type Doors (canopy)

				
Article	F Type Roller Spindle Assembly (Pair) E clip supplied.	Pre 2002 Framed Canopy Door Spring	Pre 2002 Framed Canopy Door Spring	Pre 2002 Framed Canopy Door Spring
Ref. No.	1160	2149	2150	2151
Price £	31.00	112.00	136.00	136.00

				
Article	Pre 2002 Framed Canopy Door Spring	Pre 2002 Framed Canopy Door Spring	Framed Canopy Link Arm Supplied with pin spacer and washer. Pre March 2002.	Framed Canopy Spring Anchor Top Pin Pre March 2002.
Ref. No.	2152	2153	(LH) 1199. (RH) 1200	1197
Price £	136.00	148.00	48.00	19.00

# Canopy Doors

## C Type Side Extension Spring fitted to a timber frame - Steel Panel Doors

Used on all Canopy doors between 1999 and 2002. Springs priced and supplied individually. However, it is always recommended that both springs are replaced at the same time.



For price, please see page 30

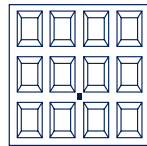

Georgian/  
Georgian Elite

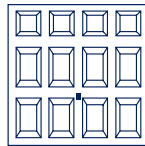

Beaumont/  
Beaumont Elite

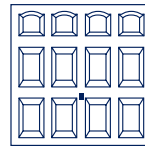

Cathedral/  
Cathedral Elite

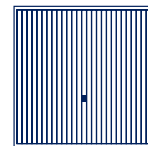

Carlton/  
Carlton Elite

	Georgian/ Georgian Elite		Beaumont/ Beaumont Elite		Cathedral/ Cathedral Elite		Carlton/ Carlton Elite	
	Spring box number	No. of bands & Colour	Spring box number	No. of bands & Colour	Spring box number	No. of bands & Colour	Spring box number	No. of bands & Colour
6'6"x6'3"	-	-	-	-	-	-	4733	White
6'6"x6'6"	4735	Green	-	-	-	-	4733	White
6'6"x7'0"	4737	Red	-	-	-	-	4734	2 x White
7'0"x6'3"	-	-	-	-	-	-	4733	White
7'0"x6'6"	4735	Green	4735	Green	4735	Green	4733	White
7'0"x7'0"	4737	Red	4736	2 x Green	4736	2 x Green	4734	2 x White
7'3 1/2"x6'4"	-	-	-	-	-	-	4734	2 x White
7'5"x6'3"	-	-	-	-	-	-	4734	2 x White
7'5"x6'6"	4736	2 x Green	4735	Green	4735	Green	4734	2 x White
7'5"x7'0"	4737	Red	4737	Red	4737	Red	4735	Green
7'6"x6'6"	4736	2 x Green	4736	2 x Green	4736	2 x Green	4735	Green
7'6"x7'0"	4737	Red	4737	Red	4737	Red	4736	2 x Green
7'8 1/2"x6'3"	-	-	-	-	-	-	4733	White
7'8 1/2"x6'6 3/4"	4736	2 x Green	4736	2 x Green	4736	2 x Green	4734	2 x White
7'8 1/2"x6'11 3/4"	4737	Red	4736	2 x Green	4736	2 x Green	4735	Green
8'0"x6'3"	-	-	-	-	-	-	4735	Green
8'0"x6'6"	4738	2 x Red	4736	2 x Green	4736	2 x Green	4736	2 x Green
8'0"x7'0"	4738	2 x Red	4737	Red	4737	Red	4736	2 x Green
8'2 1/2"x6'3"	-	-	-	-	-	-	4735	Green
8'2 1/2"x6'6 3/4"	-	-	-	-	-	-	4736	2 x Green
8'2 1/2"x6'11 3/4"	-	-	-	-	-	-	4736	2 x Green

# Canopy Doors

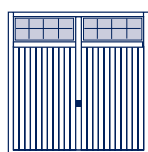
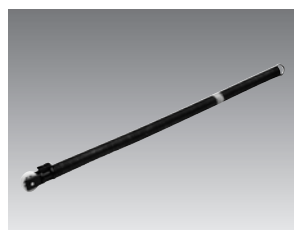

Salisbury/  
Salisbury Elite

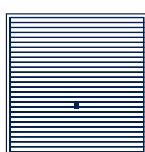

Horizon/  
Horizon Elite

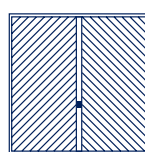

Chevron/  
Chevron Elite

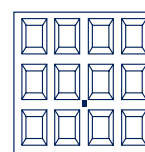

Parade  
White/Brown

	Salisbury/ Salisbury Elite		Horizon/ Horizon Elite		Chevron/ Chevron Elite		Parade White/Brown	
	Spring box number	No. of bands & Colour	Spring box number	No. of bands & Colour	Spring box number	No. of bands & Colour	Spring box number	No. of bands & Colour
6'6"x6'3"	-	-	4733	White	-	-	-	-
6'6"x6'6"	-	-	4733	White	4733	White	-	-
6'6"x7'0"	-	-	4734	2 x White	4734	2 x White	-	-
7'0"x6'3"	-	-	4733	White	-	-	-	-
7'0"x6'6"	4735	Green	4733	White	4734	2 x White	4735	Green
7'0"x7'0"	4737	Red	4734	2 x White	4734	2 x White	4736	2 x Green
7'3 <sup>1</sup> / <sub>2</sub> "x6'4"	-	-	4733	White	-	-	-	-
7'5"x6'3"	-	-	4733	White	-	-	-	-
7'5"x6'6"	4737	Red	4733	White	4735	Green	4735	Green
7'5"x7'0"	4737	Red	4734	2 x White	4738	2 x Red	4737	Red
7'6"x6'6"	4737	Red	4735	Green	4736	2 x Green	4736	2 x Green
7'6"x7'0"	4737	Red	4735	Green	4738	2 x Red	4737	Red
7'8 <sup>1</sup> / <sub>2</sub> "x6'3"	-	-	4733	White	-	-	-	-
7'8 <sup>1</sup> / <sub>2</sub> "x6'6 <sup>3</sup> / <sub>4</sub> "	-	-	4734	2 x White	4736	2 x Green	4736	2 x Green
7'8 <sup>1</sup> / <sub>2</sub> "x6'11 <sup>3</sup> / <sub>4</sub> "	-	-	4735	Green	4738	2 x Red	4736	2 x Green
8'0"x6'3"	-	-	4735	Green	-	-	-	-
8'0"x6'6"	4737	Red	4735	Green	-	-	4736	2 x Green
8'0"x7'0"	4738	2 x Red	4735	Green	-	-	4737	Red
8'2 <sup>1</sup> / <sub>2</sub> "x6'3"	-	-	4735	Green	-	-	-	-
8'2 <sup>1</sup> / <sub>2</sub> "x6'6 <sup>3</sup> / <sub>4</sub> "	-	-	4735	Green	-	-	-	-
8'2 <sup>1</sup> / <sub>2</sub> "x6'11 <sup>3</sup> / <sub>4</sub> "	-	-	4736	2 x Green	-	-	-	-

For price, please see page 30

# Canopy Doors

## C Type Side Extension Spring fitted to a timber frame - GRP Premier Panel Doors

Used on all Canopy doors between 1999 and 2002. Springs priced and supplied individually. However, it is always recommended that both springs are replaced at the same time.



For price, please see page 30

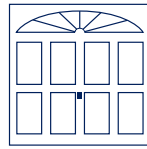

Stamford

Spring box number	No. of bands & Colour
-------------------	-----------------------

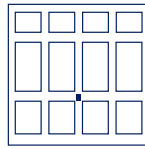

Arden

Spring box number	No. of bands & Colour
-------------------	-----------------------

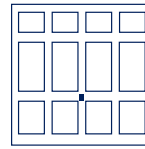

Kenmore

Spring box number	No. of bands & Colour
-------------------	-----------------------

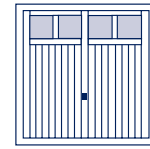

Derwent

Spring box number	No. of bands & Colour
-------------------	-----------------------

7'0"x6'6"	4734	2 x White	4734	2 x White	4734	2 x White	4734	2 x White
7'0"x7'0"	4735	Green	4735	Green	4735	Green	4735	Green
7'5"x6'6"	4734	2 x White	4734	2 x White	4734	2 x White	4734	2 x White
7'6"x7'0"	4735	Green	4735	Green	4735	Green	4735	Green



For price, please see page 30

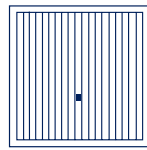

Swinton

Spring box number	No. of bands & Colour
-------------------	-----------------------

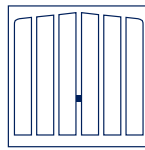

Clifton

Spring box number	No. of bands & Colour
-------------------	-----------------------

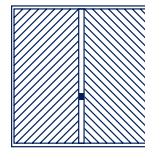

Oakham

Spring box number	No. of bands & Colour
-------------------	-----------------------

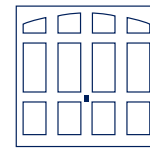

Woburn

Spring box number	No. of bands & Colour
-------------------	-----------------------

7'0"x6'6"	4734	2 x White	4734	2 x White	4734	2 x White	4734	2 x White
7'0"x7'0"	4735	Green	4735	Green	4735	Green	4735	Green
7'5"x6'6"	4734	2 x White	4734	2 x White	4734	2 x White	4734	2 x White
7'6"x7'0"	4735	Green	4735	Green	4735	Green	4735	Green

# Canopy Doors

## C Type Side Extension Spring fitted to a timber frame - Timber Panel Doors

Used on all Canopy doors between 1999 and 2002. Springs priced and supplied individually. However, it is always recommended that both springs are replaced at the same time.

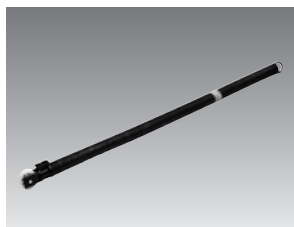

For price, please see page 30

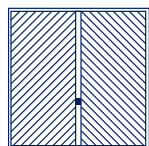

Chevron Cedar

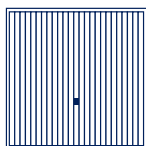

Vertical Cedar

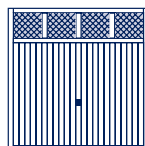

Sandhurst

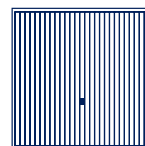

Cavendish

	Chevron Cedar		Vertical Cedar		Sandhurst		Cavendish	
	Spring box number	No. of bands & Colour	Spring box number	No. of bands & Colour	Spring box number	No. of bands & Colour	Spring box number	No. of bands & Colour
7'0"x6'6"	4734	2 x White	4733	White	-	-	-	-
7'0"x7'0"	4735	Green	4734	2 x White	4736	2 x Green	4736	2 x Green
7'5"x6'6"	4735	Green	4733	White	4735	Green	4735	Green
7'5"x7'0"	4735	Green	4734	2 x White	4736	2 x Green	4736	2 x Green
7'6"x6'6"	4735	Green	4734	2 x White	4735	Green	4735	Green
7'6"x7'0"	-	-	4734	2 x White	-	-	-	-



For price, please see page 30

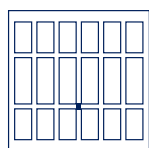

Wolsey

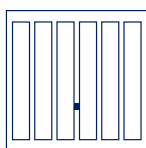

Seymour

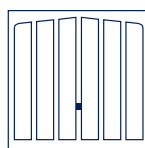

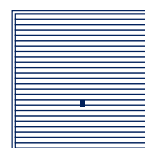

Tudor







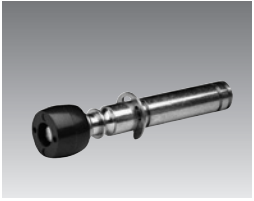
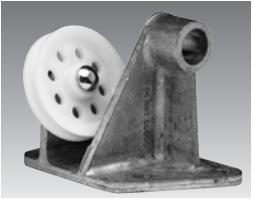



Horizontal Cedar

	Wolsey		Seymour		Tudor		Horizontal Cedar	
	Spring box number	No. of bands & Colour	Spring box number	No. of bands & Colour	Spring box number	No. of bands & Colour	Spring box number	No. of bands & Colour
7'0"x6'6"	4735	Green	4735	Green	4735	Green	N/A	N/A
7'0"x7'0"	4735	Green	4735	Green	4735	Green	N/A	N/A
7'5"x6'6"	4735	Green	4735	Green	4735	Green	N/A	N/A
7'5"x7'0"	4736	2 x Green	4736	2 x Green	4736	2 x Green	N/A	N/A
7'6"x6'6"	4735	Green	4735	Green	4735	Green	-	-
7'6"x7'0"	4736	2 x Green	4736	2 x Green	4736	2 x Green	-	-

## Accessories for doors with C Type Side Extension Springs 1999 - 2002 (canopy)

				
Article	Side Extension Spring Cables Sold in pairs. 1999 - 2002.	Roller and Spindle Assembly (Pair) Side extension spring.	Wall Bracket Assembly for canopy doors 1999 - 2002.	C Type Side Extension Spring 1999 - 2002.
Ref. No.	1157	1161	(LH) 1206. (RH) 1207	4733
Price £	31.00 (per pair)	41.00	28.00	73.00

				
Article	C Type Side Extension Spring 1999 - 2002.	C Type Side Extension Spring 1999 - 2002.	C Type Side Extension Spring 1999 - 2002.	C Type Side Extension Spring 1999 - 2002.
Ref. No.	4734	4735	4736	4737
Price £	73.00	73.00	73.00	73.00

				
Article	C Type Side Extension Spring 1999 - 2002.	Spring Anchor Bracket 1999 - 2002.	S Hook For canopy doors. 1999 - 2002.	Right Link Arm (bare) For canopy doors. 1999 - 2002.
Ref. No.	4738	1208	1194	(LH) 1204. (RH) 1205
Price £	73.00	13.00	12.00	31.00

# Framed Retractable and Retractable Doors

## Framed Retractable and Retractable and Double Retractable Spring - Steel Panel Doors

Used on all FR and R type doors pre 2002 (595 mm long). Springs priced and supplied individually. However, it is always recommended that both springs are replaced at the same time.



For price, please see pages 35 and 36

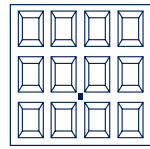

Georgian/  
Georgian Elite

Spring Type

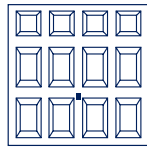

Beaumont/  
Beaumont Elite

Spring Type

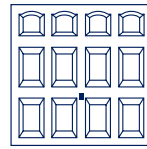

Cathedral/  
Cathedral Elite

Spring Type

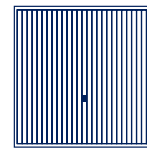

Carlton/  
Carlton Elite

Spring Type

6'6"x6'3"	-	-	-	N/A
6'6"x6'6"	4763	-	-	4776
6'6"x7'0"	4765	-	-	4777
7'0"x6'3"	-	-	-	N/A
7'0"x6'6"	4764	4763	4763	4776
7'0"x7'0"	4765	4764	4764	4763
7'3 1/2"x6'4"	-	-	-	N/A
7'5"x6'3"	-	-	-	N/A
7'5"x6'6"	4764	4764	4764	4777
7'5"x7'0"	4766	4765	4765	4766
7'6"x6'6"	4766	4764	4764	4764
7'6"x7'0"	4768	4765	4765	4766
7'8 1/2"x6'3"	-	-	-	N/A
7'8 1/2"x6'6 3/4"	4768	4766	4766	4764
7'8 1/2"x6'11 3/4"	4769	4768	4768	4764
8'0"x6'3"	-	-	-	N/A
8'0"x6'6"	4768	4766	4766	4764
8'0"x7'0"	4769	4768	4768	4767
8'2 1/2"x6'3"	-	-	-	N/A
8'2 1/2"x6'6 3/4"	-	-	-	-
8'2 1/2"x6'11 3/4"	-	-	-	-
9'0"x6'6"	4775	-	-	4769
9'0"x7'0"	4776	-	-	4769
10'0"x6'6"	4776	-	-	4774
10'0"x7'0"	4776	-	-	4775
11'0"x6'6"	4777	-	-	4775
11'0"x7'0"	4777	-	-	4776
12'0"x6'6"	4763	-	-	4776
12'0"x7'0"	4764	-	-	4777
13'0"x6'6"	4768	-	-	4764
13'0"x7'0"	4769	-	-	4766
14'0"x6'6"	4769	-	-	4766
14'0"x7'0"	4770	-	-	4768
15'0"x6'6"	-	-	-	4768
15'0"x7'0"	-	-	-	4769
16'0"x6'6"	-	-	-	4769
16'0"x7'0"	-	-	-	4770

Last three digits identification stamped onto alloy tag and or spring eye. See page 14 for spring conversion chart.

# Retractable Doors



For price, please see  
pages 35 and 36

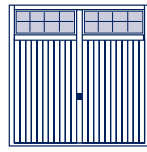

Salisbury/  
Salisbury Elite

Spring Type

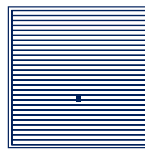

Horizon/  
Horizon Elite

Spring Type

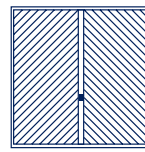

Chevron/  
Chevron Elite

Spring Type

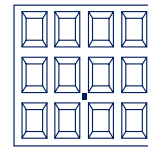

Parade  
White/Brown

Spring Type

	Salisbury/ Salisbury Elite	Horizon/ Horizon Elite	Chevron/ Chevron Elite	Parade White/Brown
6'6"x6'3"	-	N/A	-	-
6'6"x6'6"	-	4775	4776	-
6'6"x7'0"	-	4776	4765	-
7'0"x6'3"	-	N/A	-	-
7'0"x6'6"	4764	4775	4777	4763
7'0"x7'0"	4766	4777	4764	4764
7'3 1/2"x6'4"	-	N/A	-	-
7'5"x6'3"	-	N/A	-	-
7'5"x6'6"	4768	4776	4776	4764
7'5"x7'0"	4766	4763	4763	4765
7'6"x6'6"	4766	4776	4766	4764
7'6"x7'0"	4766	4763	4768	4764
7'8 1/2"x6'3"	-	N/A	-	-
7'8 1/2"x6'6 3/4"	-	4763	4764	-
7'8 1/2"x6'11 3/4"	-	4764	4766	-
8'0"x6'3"	-	N/A	-	-
8'0"x6'6"	4766	4763	-	4766
8'0"x7'0"	4768	4764	-	4768
8'2 1/2"x6'3"	-	N/A	-	-
8'2 1/2"x6'6 3/4"	-	-	-	4766
8'2 1/2"x6'11 3/4"	-	-	-	4768
9'0"x6'6"	-	4769	-	-
9'0"x7'0"	-	4769	-	-
10'0"x6'6"	-	4769	-	-
10'0"x7'0"	-	4774	-	-
11'0"x6'6"	-	4774	-	-
11'0"x7'0"	-	4775	-	-
12'0"x6'6"	-	4775	-	-
12'0"x7'0"	-	4776	-	-
13'0"x6'6"	-	4777	-	-
13'0"x7'0"	-	4763	-	-
14'0"x6'6"	-	4764	-	4769
14'0"x7'0"	-	4766	-	4770
15'0"x6'6"	-	4766	-	-
15'0"x7'0"	-	4766	-	-
16'0"x6'6"	-	4769	-	-
16'0"x7'0"	-	4770	-	-

Last three digits identification stamped onto alloy tag and or spring eye. See page 14 for spring conversion chart.



# Framed Retractable and Retractable Doors

**Framed Retractable and Retractable and Double Retractable Type Spring - GRP Premier Panel Doors**  
 Used on all FR and R type doors pre 2002. Springs priced and supplied individually.



For price, please see  
pages 35 and 36

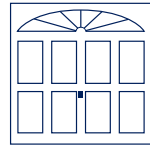

Stamford

Spring Type

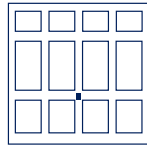

Arden

Spring Type

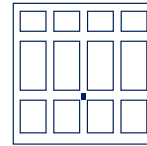

Kenmore

Spring Type

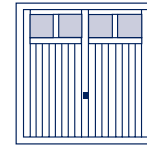

Derwent

Spring Type

7'0"x6'6"	4766	4766	4766	4766
7'0"x7'0"	4766	4766	4766	4766
7'5"x6'6"	4766	4766	4766	4766
7'6"x7'0"	4766	4766	4766	4766
9'0"x6'6"	4769	4769	4769	-
9'0"x7'0"	4769	4769	4769	-
10'0"x6'6"	4769	4769	4769	-
10'0"x7'0"	4769	4774	4774	-
11'0"x6'6"	-	4774	4774	-
11'0"x7'0"	-	4775	4775	-
12'0"x6'6"	-	4776	4776	-
12'0"x7'0"	-	4776	4776	-
14'0"x6'6"	4763	4763	4763	-



For price, please see  
pages 35 and 36

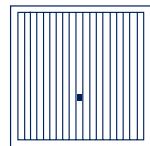

Swinton

Spring Type

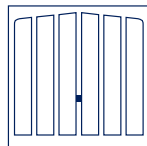

Clifton

Spring Type

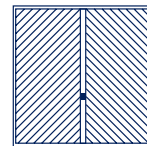

Oakham

Spring Type

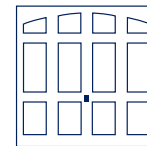

Woburn

Spring Type

7'0"x6'6"	4766	4766	4766	4766
7'0"x7'0"	4766	4766	4766	4766
7'5"x6'6"	4766	4766	4766	4766
7'6"x7'0"	4766	4766	4766	4766
9'0"x6'6"	-	4769	-	-
9'0"x7'0"	-	4769	-	-
10'0"x6'6"	-	4769	-	-
10'0"x7'0"	-	4774	-	-
11'0"x6'6"	-	-	-	-
11'0"x7'0"	-	-	-	-
12'0"x6'6"	-	-	-	-
12'0"x7'0"	-	-	-	-
14'0"x6'6"	-	4763	-	-

Last three digits identification stamped onto alloy tag and or spring eye. See page 14 for spring conversion chart.

# Framed Retractable and Retractable Doors

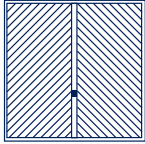
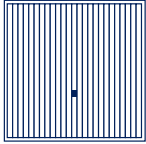
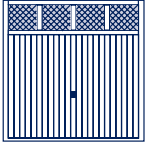
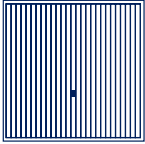

**Framed Retractable and Retractable and Double Retractable Type Spring - Timber Panel Doors**  
 Used on all FR and R type doors pre 2002. Springs priced and supplied individually.

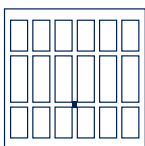
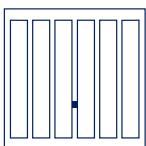
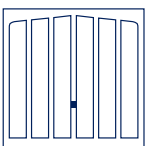
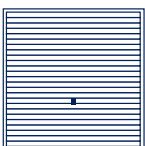



 <p>For price, please see pages 35 and 36</p>	 <p>Chevron Cedar</p> <p>Spring Type</p>	 <p>Vertical Cedar</p> <p>Spring Type</p>	 <p>Sandhurst</p> <p>Spring Type</p>	 <p>Cavendish</p> <p>Spring Type</p>
	7'0"x6'6"	4763	4775	-
7'0"x7'0"	4764	4775	4766	4766
7'5"x6'6"	4764	4776	4764	4764
7'5"x7'0"	4766	4763	4766	4766
7'6"x6'6"	4764	4763	4764	4764
7'6"x7'0"	4764	4763	-	-
14'0"x6'6"	-	4768	4766	4766
14'0"x7'0"	-	4768	4768	4768

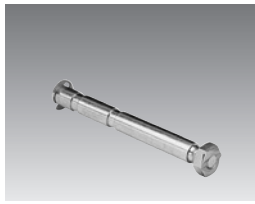
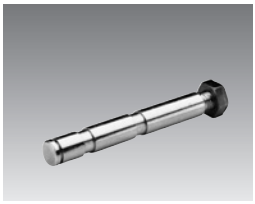



 <p>For price, please see pages 35 and 36</p>	 <p>Wolsey</p> <p>Spring Type</p>	 <p>Seymour</p> <p>Spring Type</p>	 <p>Tudor</p> <p>Spring Type</p>	 <p>Horizontal Cedar</p> <p>Spring Type</p>
	7'0"x6'6"	4764	4764	4764
7'0"x7'0"	4764	4764	4764	N/A
7'5"x6'6"	4764	4764	4764	N/A
7'5"x7'0"	4766	4766	4766	N/A
7'6"x6'6"	4764	4764	4764	-
7'6"x7'0"	4766	4766	4766	-
14'0"x6'6"	4763	4763	4763	-
14'0"x7'0"	4764	4764	4764	-

Last three digits identification stamped onto alloy tag and or spring eye. See page 14 for spring conversion chart.

# Single and Double Retractable Gear Components

				
Article	Spring Anchor Pin E-clip supplied suitable for DC/DR/FR/R. Sold individually.	Spring Anchor Pin Suitable for R/FR/DR from 1988 to 2002.	Single. Double and Framed Retractable Door Spring - 595 mm Sold individually. Pre 2002.	Single. Double and Framed Retractable Door Spring - 595 mm Sold individually. Pre 2002.
Ref. No.	1211	1214	4763	4764
Price £	18.00	14.00	100.00	100.00

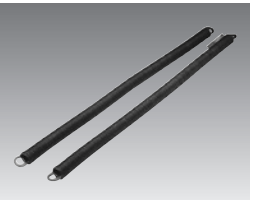

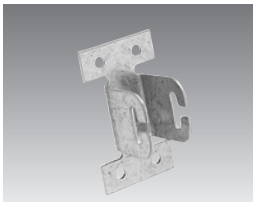

				
Article	Single. Double and Framed Retractable Door Spring - 595 mm Sold individually. Pre 2002.	Single. Double and Framed Retractable Door Spring - 595 mm Sold individually. Pre 2002.	Single. Double and Framed Retractable Door Spring - 595 mm Sold individually. Pre 2002.	Single. Double and Framed Retractable Door Spring - 595 mm Sold individually. Pre 2002.
Ref. No.	4765	4766	4768	4769
Price £	100.00	100.00	100.00	100.00



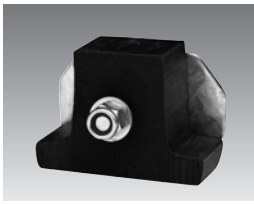

				
Article	Single. Double and Framed Retractable Door Spring - 595 mm Sold individually. Pre 2002.	Single. Double and Framed Retractable Door Spring - 595 mm Sold individually. Pre 2002.	Single. Double and Framed Retractable Door Spring - 595 mm Sold individually. Pre 2002.	Single. Double and Framed Retractable Door Spring - 595 mm Sold individually. Pre 2002.
Ref. No.	4770	4774	4775	4776
Price £	100.00	100.00	100.00	100.00





		
Article	Single. Double and Framed Retractable Door Spring - 595 mm Sold individually. Pre 2002.	Spring Anchor Bracket From 1988 - 2002.
Ref. No.	4777	345
Price £	100.00	16.00

For retractable door spring, last three digits identification stamped onto alloy tag and or spring eye. See page 14 for spring conversion chart.

# Double Canopy Doors

				
Article	Rubber stop DC type only from 1992.	Double Canopy Door Spring - 685 mm Sold individually. Pre 2002.	Double Canopy Door Spring - 685 mm Sold individually. Pre 2002.	Double Canopy Door Spring - 685 mm Sold individually. Pre 2002.
Ref. No.	1213	4773	4748	4749
Price £	18.00	100.00	100.00	100.00

				
Article	Double Canopy Door Spring - 685 mm Sold individually. Pre 2002.	Double Canopy Door Spring - 685 mm Sold individually. Pre 2002.	Double Canopy Door Spring - 685 mm Sold individually. Pre 2002.	Double Canopy Door Spring - 685 mm Sold individually. Pre 2002.
Ref. No.	4750	4751	4752	4753
Price £	100.00	100.00	100.00	100.00

				
Article	Double Canopy Door Spring - 685 mm Sold individually. Pre 2002.	Double Canopy Door Spring - 685 mm Sold individually. Pre 2002.	Double Canopy Door Spring - 685 mm Sold individually. Pre 2002.	Double Canopy Door Spring - 685 mm Sold individually. Pre 2002.
Ref. No.	4754	4755	4756	4757
Price £	100.00	100.00	100.00	100.00

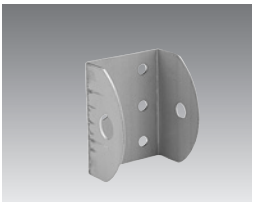
		
Article	Double Canopy Door Spring - 685 mm Sold individually. Pre 2002.	Roller Bracket (on door) Suitable for DC/DR from 1988 to 2002.
Ref. No.	4758	344
Price £	100.00	13.00

For retractable door spring, last three digits identification stamped onto alloy tag and or spring eye. See page 14 for spring conversion chart.

# Double Canopy Doors

## Double Canopy Type Spring - Steel Panel Doors

Used on all DC and DR type doors pre 2002 (685 mm long).



For price, please see page 36

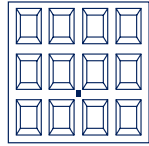

Georgian

DC Spring

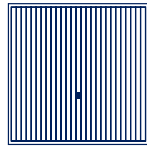

Carlton

DC Spring

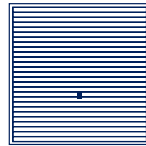

Horizon

DC Spring

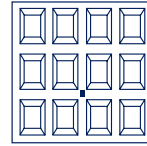

Parade White/Brwon

DC Spring

9'0"x6'6"	4755	4754	4752	-
9'0"x7'0"	4756	4754	4754	-
10'0"x6'6"	4756	4754	4752	-
10'0"x7'0"	4756	4756	4754	-
11'0"x6'6"	4756	4755	4754	-
11'0"x7'0"	4757	4757	4756	-
12'0"x6'6"	4758	4756	4755	-
12'0"x7'0"	4758	4758	4757	-
13'0"x6'6"	4750	4758	4757	-
13'0"x7'0"	4752	4749	4758	-
14'0"x6'6"	4751	4748	4758	4753
14'0"x7'0"	4753	4750	4758	4754
15'0"x6'6"	-	4758	4758	-
15'0"x7'0"	-	4752	4750	-
16'0"x6'6"	-	4751	4750	-
16'0"x7'0"	-	4753	4752	-

Double doors not sold as Elite.

Last three digits identification stamped onto alloy tag and or spring eye. See page 14 for spring conversion chart.

# Double Canopy type Doors

## Double Canopy Type Spring - GRP Premier Panel Doors

Used on all DC and DR type doors pre 2002.



For price, please see page 36

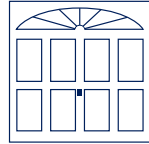

Stamford

DC Spring

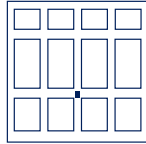

Arden

DC Spring

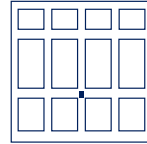

Kenmore

DC Spring

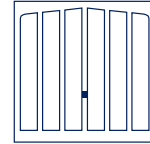

Clifton

DC Spring

9'0"x6'6"	4750	4750	4750	4750
9'0"x7'0"	4753	4753	4753	4753
10'0"x6'6"	4753	4753	4753	4753
10'0"x7'0"	4755	4755	4755	4755
11'0"x6'6"	-	4754	4754	-
11'0"x7'0"	-	4756	4756	-
12'0"x6'6"	-	4755	4755	-
12'0"x7'0"	-	4757	4757	-
14'0"x6'6"	4757	4757	4757	4757

## Double Canopy Type Spring - Timber Panel Doors

Used on all DC and DR type doors pre 2002.



For price, please see page 36

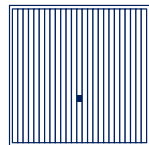

Vertical Cedar

DC Spring

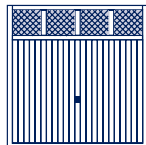

Sandhurst

DC Spring

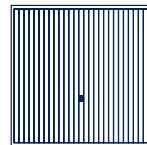

Cavendish

DC Spring

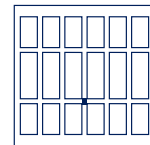

Wolsey

DC Spring

14'0"x6'6"	4748	4751	4751	4748
14'0"x7'0"	4748	4750	4750	4749



For price, please see page 36

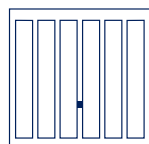

Seymour

DC Spring

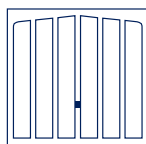



Tudor





DC Spring

14'0"x6'6"	4748	4748
14'0"x7'0"	4749	4749

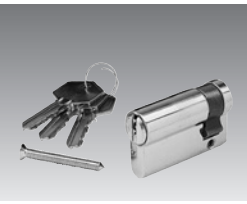
Last three digits identification stamped onto alloy tag and or spring eye. See page 14 for spring conversion chart.



# Handles, Lock Assemblies and Keys

				
Article	<b>ZA Series Locks</b> Includes keys, washers, nuts and bolts. Back face - ZA0001-ZA0200. Supplied with 2 keys.	<b>ZA Series Keys</b> Key numbers between: ZA/0001 - ZA/0200. Supplied with 2 keys.	<b>92 Series Keys</b> Key numbers between: 92/201 - 92/400. Supplied with 2 keys.	<b>Lock Barrel (1992 - 1998)</b> Length 40 mm. For steel doors. Supplied with 2 keys.
Ref. No.	1164	1162	1163	1165
Price £	54.00	13.00	13.00	31.00

				
Article	<b>Lock Barrel (1992 - 1998)</b> Length 50 mm. T&G Timber. Supplied with 2 keys.	<b>Lock Barrel (1992 - 1998)</b> Length 70 mm. GRP/Elizabethan. Supplied with 2 keys.	<b>Single Door Brass Handle</b> 1998 - April 2002.	<b>Handle Conversion Kit</b> Includes 2 keys, washer, plastic cups, screws, counterplates, plastic crank, slit bolt and nut.
Ref. No.	1166	1173	1183	1171
Price £	41.00	41.00	39.00	84.00

		
Article	<b>T- Handle Assembly</b> Includes 2 keys, washer, slit bolt and nut, plastic cups and screws. Key no. between 201 and 400.	<b>Handle Repair Kit</b> DR/DC type only up to Dec. 1993 (latch cable only).
Ref. No.	1191	1170
Price £	76.00	26.00

# Garage Side Doors



				
Article	Black Lever/ Knob Handle Side Hinged Doors	Black Lever/ Lever Handle Side Hinged Doors	White Lever/ Lever Handle Side Hinged Doors	Chrome Effect Lever/ Lever Handle Side Hinged Doors
Ref. No.	3348	6152	3349	3351
Price £	30.00	34.00	117.00	145.00

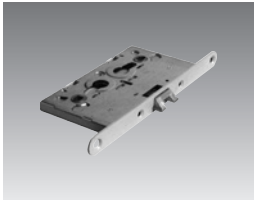
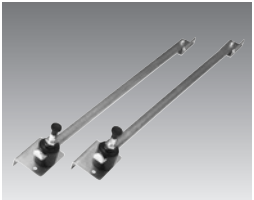

				
Article	Shoot Bolt For side hinged door. 2002 - current.	Door Hinge for Sidehung Garage Door (please state colour required).	Cylinder for Side Hinged steel doors Supplied with 3 keys.	Cylinder for Side Hinged timber doors
Ref. No.	395	385	393	6112
Price £	28.00	32.00	42.00	42.00



		
Article	Lock Body 2002 - current.	Side Hung Door Stays
Ref. No.	390	2449
Price £	52.00	73.00

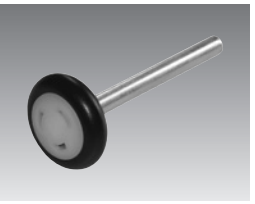
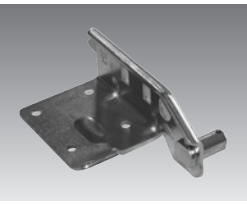

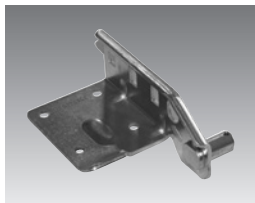
## Springs and Brackets

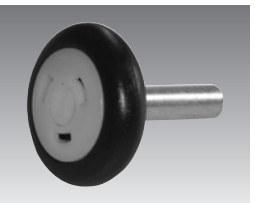
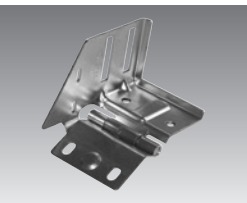
				
Article	Bottom Roller Bracket Tension Track Right Version	Bottom Roller Bracket Tension Track Left Version	110 mm Bottom Roller Tension Track	Bottom Roller Bracket Torsion/Torsion Low Headroom Track Right Version
Ref. No.	1876	5103	5360	3361
Price £	13.00	13.00	15.00	17.00

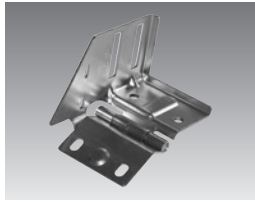
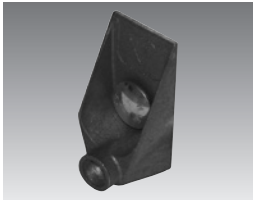

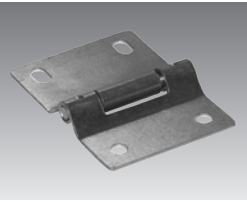
				
Article	Bottom Roller Bracket Torsion/Torsion Low Headroom Track Left Version	Pin and Spacer Torsion/Torsion Low Headroom Track	50 mm Bottom Roller Torsion/Torsion Low Headroom Track	Intermediate Roller Bracket Tension, Torsion and Torsion Low Headroom Track Right Version
Ref. No.	3362	3364	3363	3358
Price £	17.00	9.00	11.00	16.00

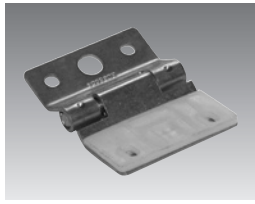
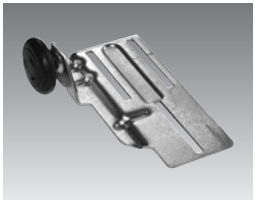
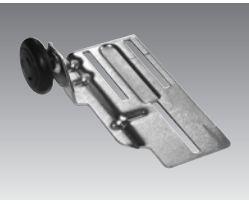

				
Article	Intermediate Roller Bracket Tension, Torsion and Torsion Low Headroom Track Left Version	Roller Holder	40 mm Intermediate Roller Tension, Torsion and Torsion Low Headroom Track	Intermediate Panel Hinge (not for LTH or Wicket Door)
Ref. No.	3359	5570	3365	3360
Price £	16.00	11.00	12.00	11.00

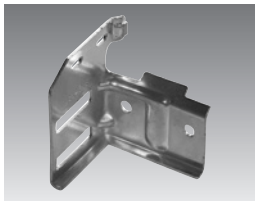
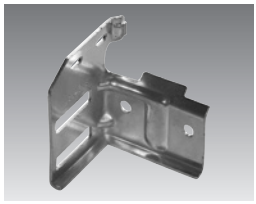
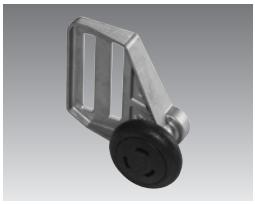
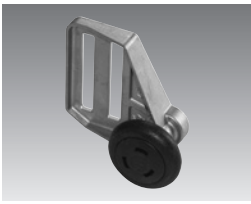
			
Article	Intermediate Panel Hinge (LTH only)	Top Roller Bracket and Roller Tension Track Right Version	Top Roller Bracket and Roller Tension Track Left Version
Ref. No.	7096	2629	2749
Price £	12.00	17.00	17.00

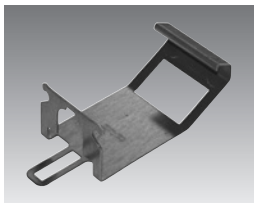
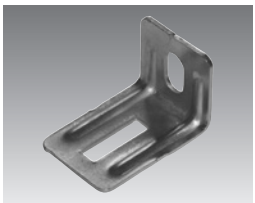
# Springs and Brackets

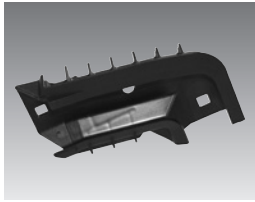
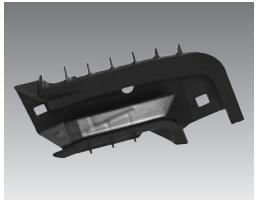

				
Article	Top Roller Bracket Torsion Track Right Version	Top Roller Bracket Torsion Track Left Version	Top Holder and Roller Torsion Track Right Version	Top Holder and Roller Torsion Track Left Version
Ref. No.	3356	3357	3354	3355
Price £	19.00	19.00	25.00	25.00

				
Article	Top Roller Bracket and Roller Low Headroom Torsion Track	Horizontal Track Support Bracket	Frame Fixing Bracket Tension, Torsion and Torsion Low Headroom Track	Buffer Spring Tension and Torsion Low Headroom Track
Ref. No.	1587	7098	7099	7100
Price £	17.00	9.00	7.00	15.00

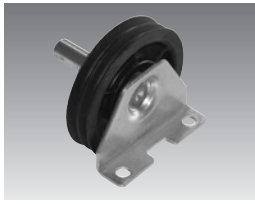
				
Article	Guide Curve Tension and Torsion Low Headroom Track Right Version	Guide Curve Tension and Torsion Low Headroom Track Left Version	Travel Limit Assembly Tension Track	Cable Clasp Tension Track (incl. shouldered fixing)
Ref. No.	5254	5255	1880	4063
Price £	25.00	25.00	12.00	13.00

	
Article	Cable Support Bracket and Pulley Tension Track
Ref. No.	4065
Price £	18.00

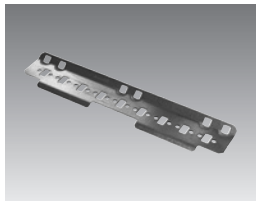
## Springs and Brackets

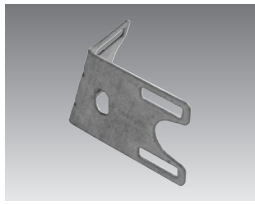
			
Article	Spring Tension Plate Tension Track	Shaft Support Holder Torsion Track	Shaft Support Bracket Torsion Track
Ref. No.	4064	7101	7102
Price £	10.00	13.00	12.00

# Cones and Drums

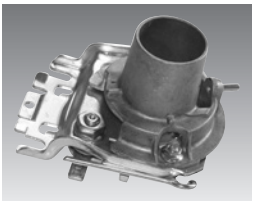
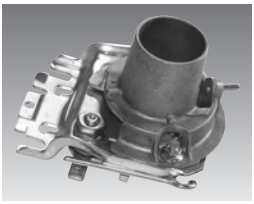
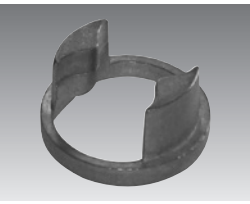
				
Article	Shaft Coupling Torsion/Torsion Low Headroom Track	Spring Safety Device with Cone Seat Torsion/Torsion Low Headroom Track Right Version	Spring Safety Device with Cone Seat Torsion/Torsion Low Headroom Track Left Version	Adapter for Spring Safety Device Torsion/Torsion Low Headroom Track
Ref. No.	5572	7104	5573	5574
Price £	28.00	96.00	96.00	6.00

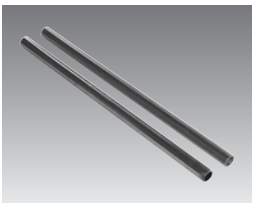
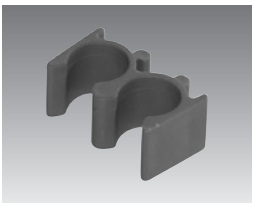
			
Article	Spring Tensioning Cone Torsion/Torsion Low Headroom Track	Tensioning Spindle Torsion/Torsion Low Headroom Track	Tensioning Spindle Clamp Torsion/Torsion Low Headroom Track
Ref. No.	7105	7106	7107
Price £	32.00	13.00 (pair)	6.00

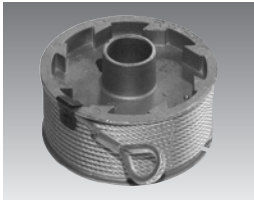
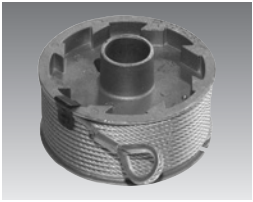
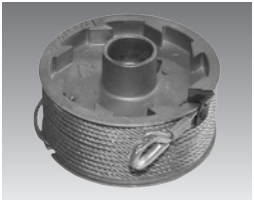
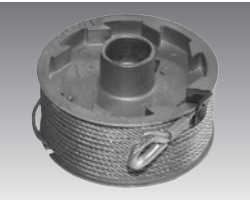
				
Article	Cable Drum ( $\leq 2250$ mm) Torsion/Torsion Low Headroom Track Right Version	Cable Drum ( $\leq 2250$ mm) Torsion/Torsion Low Headroom Track Left Version	Cable Drum ( $> 2250$ mm) Torsion/Torsion Low Headroom Track Right Version	Cable Drum ( $> 2250$ mm) Torsion/Torsion Low Headroom Track Left Version
Ref. No.	7108	7109	7110	7111
Price £	66.00	66.00	77.00	77.00

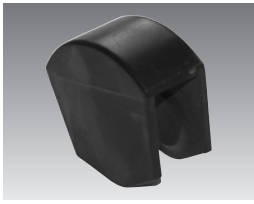
	
Article	Pulley Cover Tension Track
Ref. No.	7123
Price £	9.00

# Tension Spring Assembly

	Article	Ref. No.	Price £
	<b>Tension Spring Assembly Tension Track</b>		
	Type 1, No. 751	7124	151.00
	Type 1, No. 752	7125	154.00
	Type 1, No. 753	5219	132.00
	Type 1, No. 754	6497	135.00
	Type 2, No. 756	6497	206.00
	Type 2, No. 757	4968	243.00
	Type 1, No. 761	6608	171.00
	Type 1, No. 762	3295	173.00
	Type 1, No. 763	7127	181.00
	Type 1, No. 764	6691	151.00
	Type 1, No. 765	7128	189.00
	Type 2, No. 766	7129	229.00
	Type 1, No. 772	7130	206.00
	Type 2, No. 776	7131	254.00
	Type 2, No. 777	7132	261.00
	Type 2, No. 786	6823	246.00

# Torsion Spring Assembly



Article	Ref. No.	Price £
<b>Torsion Spring Assembly Torsion and Low Headroom Torsion Track</b>		
No. R700	7133	162.00
No. L700	8048	162.00
No. R701	7134	153.00
No. L701	6550	153.00
No. R702	6370	129.00
No. L702	7135	157.00
No. R703	7136	157.00
No. L703	6597	129.00
No. R704	7137	151.00
No. L704	6979	151.00
No. R705	7138	208.00
No. L705	6707	208.00
No. R707	7139	257.00
No. L707	6314	208.00
No. L709	6107	312.00
No. R723	7140	187.00
No. L723	7141	187.00

# Lifting Cables

	Article	Ref. No.	Price £
	<b>Lifting cable ø 3 mm Tension Track</b>		
	L = 2365 mm, Door Height 1875 mm	-	82.00
	L = 2445 mm, Door Height 1955 mm	-	82.00
	L = 2490 mm, Door Height 2000 mm	4728	82.00
	L = 2570 mm, Door Height 2080 mm	-	82.00
	L = 2615 mm, Door Height 2125 mm	3962	85.00
	L = 2695 mm, Door Height 2205 mm	6890	85.00
	L = 2740 mm, Door Height 2250 mm	7142	85.00
	L = 2865 mm, Door Height 2375 mm	7143	85.00
	L = 2990 mm, Door Height 2500 mm	7144	85.00
L = 3115 mm, Door Height 2625 mm	-	85.00	
<b>Lifting cable ø 3 mm Torsion Track</b>			
L = 3040 mm, Door Height ≤ 2250 mm	4047	30.00	
L = 3780 mm, Door Height >2250 mm	6467	36.00	
<b>Lifting cable ø 3 mm Low Headroom Torsion Track</b>			
L = 5280 mm, Door Height ≤ 2065 mm	7145	82.00	
L = 5475 mm, Door Height ≤ 2190 mm	6763	92.00	
L = 5600 mm, Door Height ≤ 2240 mm	-	90.00	
L = 5655 mm, Door Height ≤ 2250 mm	7146	90.00	
L = 6250 mm, Door Height ≤ 2490 mm	7147	90.00	
L = 6900 mm, Door Height ≤ 2830 mm	-	98.00	
L = 7300 mm, Door Height ≤ 3000 mm	-	103.00	

# Frame Fitting Packs

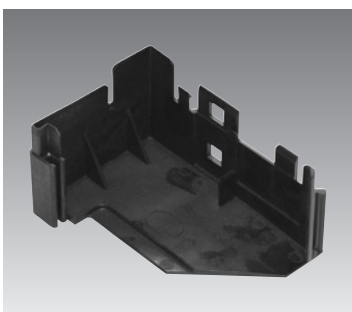



	Article	Ref. No.	Price £
	<b>Frame Leg Shoe Tension, Torsion and Low Headroom Torsion Track</b>		
	Right Version	7148	13.00
	Left Version	7149	13.00

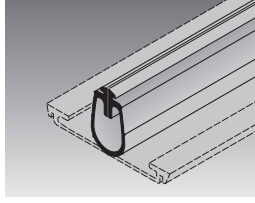
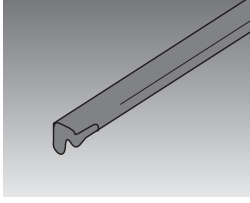
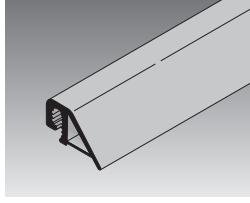
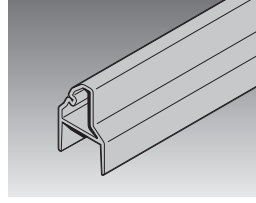







## Seals and Profiles

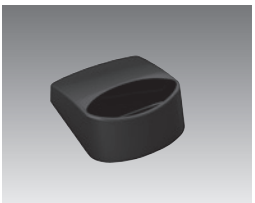
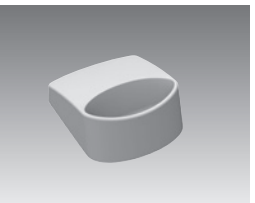

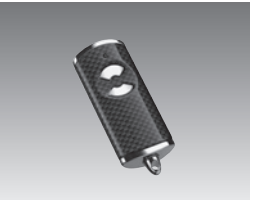

				
Article	Bottom seal	Frame side seal	Fascia seal	Shortening profile
Ref. No.	1898	7414	6234	7688
Price £ per m	43.00	9.50	14.80	75.00

# GaraMatic Operators





				
Article	5 Button Hand Transmitter (Gloss Black) 868 mHz bi-directional	5 Button Hand Transmitter (Matt Black) 868 mHz bi-directional	5 Button Hand Transmitter (Gloss White) 868 mHz bi-directional	4 Button Hand Transmitter (Gloss Black) 868 mHz bi-directional
Ref. No.	6714	7471	6713	6779
Price £	83.00	83.00	91.00	70.00

				
Article	1 Button Hand Transmitter (Gloss Black) 868 mHz bi-directional	Hand Transmitter Station (Gloss Black)	Hand Transmitter Station (Gloss White)	Hand Transmitter Sun Visor / Wall Holder
Ref. No.	6710	6719	6720	6784
Price £	67.00	16.00	16.00	14.00



				
Article	4 Button Hand Transmitter Matt Black 868 mHz bi-directional	2 Button Hand Transmitter (Gloss White) 868 mHz bi-directional	2 Button Hand Transmitter (Carbon Fibre) 868 mHz bi-directional	2 Button Hand Transmitter (Gloss Green) 868 mHz bi-directional
Ref. No.	7470	6711	6966	6965
Price £	67.00	73.00	89.00	89.00

				
Article	2 Button Hand Transmitter (Gloss Red) 868 mHz bi-directional	2 Button Hand Transmitter (Wood) 868 mHz bi-directional	2 Button Hand Transmitter (Aluminium) 868 mHz bi-directional	1 Button Transmitter For car cigarette lighter bi-directional
Ref. No.	6964	6968	6967	6782
Price £	89.00	89.00	89.00	63.00

## GaraMatic Operators



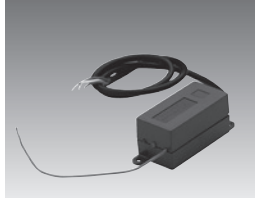

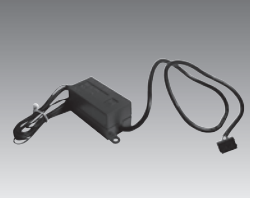
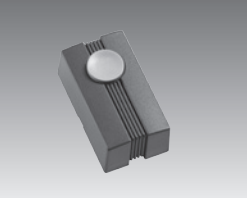
				
Article	2 Button Transmitter For car cigarette lighter bi-directional	4 Channel Key Fob Transmitter 868 mHz bi-directional	Aluminium Designer 2 Channel Transmitter 868 mHz bi-directional	Chrome Designer 2 Channel Transmitter 868 mHz bi-directional
Ref. No.	6783	6795	6780	6781
Price £	63.00	76.00	94.00	94.00



				
Article	HS4 Blue buttons 868 mHz	HSM4 Grey buttons 40 mHz	HSE2 Grey buttons 40 mHz	HE3 Internal Receiver 868 mHz bi-directional (not to be used outside)
Ref. No.	680	676	677	6785
Price £	65.00	65.00	65.00	123.00



				
Article	Radio Receiver Blue button 868 mHz (white aerial lead)	External receiver HER 1-BS	Radio Receiver Grey button 40 mHz	IT1 Push Button
Ref. No.	690	6715	685	695
Price £	100.00	225.00	90.00	22.00

Please note: GaraMatic Series 3 handsets can be downgraded to work on 868 mHz blue button handsets (HS4, HSM4, HSE2).

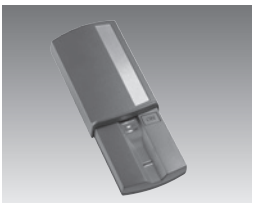
# GaraMatic Operators

				
Article	IT1 B Wired Illuminated Push Button	IT3B Wired Wall Console	FIT2 Wireless Wall Console 868 mHz bi-directional	FCT10 Wireless Code Switch (slide lid) 868 mHz bi-directional
Ref. No.	2875	2873	6718	6716
Price £	33.00	46.00	70.00	181.00

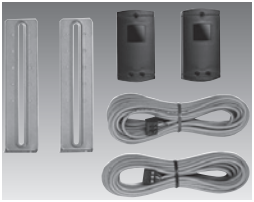
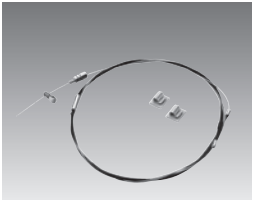

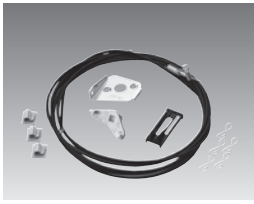
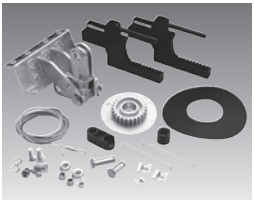
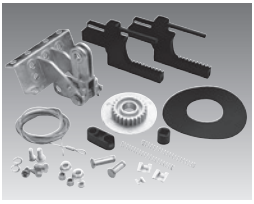
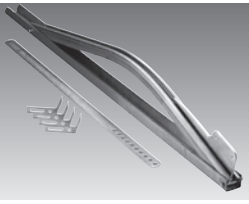

				
Article	FCT3 Wireless Code Switch 868 mHz bi-directional	FFL12 Bisecur Wireless Finger Scanner (with lid)	ESA40 Face-Fixed Key Switch	ESU40 Recessed Key Switch
Ref. No.	6717	6796	2876	2877
Price £	111.00	233.00	59.00	84.00

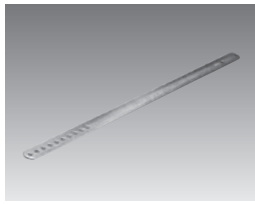
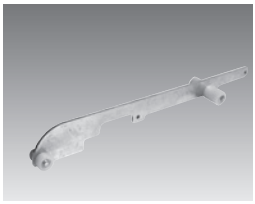
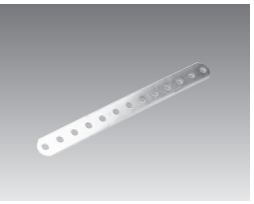
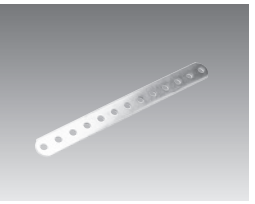

				
Article	EL101 Internal Light Beam Device	EL301N Light Beam Device	Emergency Release For retractable doors with lock and handle	Emergency Release Canopy doors or sectional doors without handles
Ref. No.	6786	2884	704	703
Price £	76.00	131.00	34.00	48.00

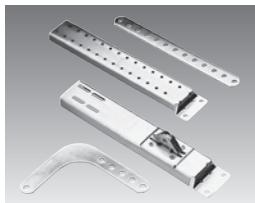
				
Article	Emergency Release For sectional doors with lock and handle	Delatching Kit For N800 double retractable doors (437.197)	Delatching Kit For N80 single retractable doors (437.195)	Bow Arm For canopy doors
Ref. No.	702	2643	705	708
Price £	49.00	88.00	53.00	116.00

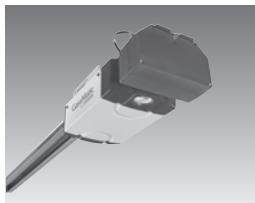

# GaraMatic Operators

				
Article	Bow Arm Connection	Canopy Extension Bracket	Extended Towing Arm 258 mm long	Extended Towing Arm 495 mm long
Ref. No.	4917	709	2482	2628
Price £	116.00	48.00	19.00	40.00

				
Article	Reinforcing Kit For sectional doors. Recommended for heavy sectional doors	Extended Towing Arm 270 mm long	Series 3 Options Relay (GaraMatic 10 and 20 add-on)	Series 3 Options Relay (GaraMatic 7 and 9 add-on)
Ref. No.	712	711	3072	5295
Price £	56.00	27.00	42.00	42.00

		
Article	Series 2 and Series 3 HNA 18-3 Battery Backup For GaraMatic Operators	Key Ring
Ref. No.	5500	4877
Price £	227.00	5.00

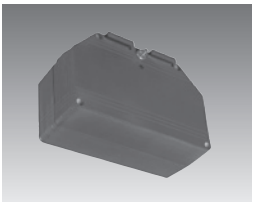
## GaraMatic Operators (Series 4)

				
Article	Series 4 Options Relay	Emergency accumulator (for Series 4 operators)	Series 4 External Bluetooth receiver (GaraMatic 9 add-on)	Series 4 External Bluetooth Antenna to increase signal range
Ref. No.	8125	8126	8129	8128
Price £	57.00	221.00	139.00	95.00

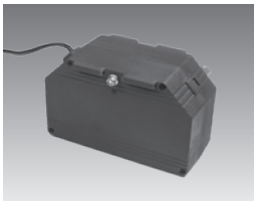
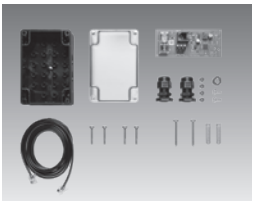
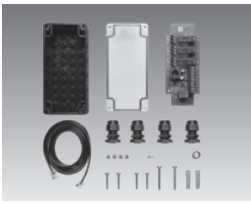

			
Article	Series 4 Emergency Battery Backup HNA 18-4	Series 4 Options relay for control of garage light, warning light or limit switch report HOR-HCP	Series 4 Universal Adapter Print for control of operator light, partial open and ventilation position UAP-1-HCP
Ref. No.	8126	8125	8421
Price £	229.00	59.00	111.00



# EuroPro

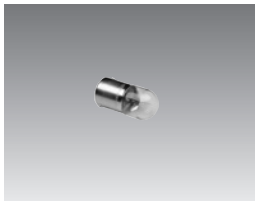

<b>Article</b>	<b>Euro Pro Hand Transmitter</b> Sold individually	<b>Eco Star Hand Transmitter</b> 433 mHz RSC2 remote hand transmitter for Euro Pro operator
<b>Ref. No.</b>	6251	7315
<b>Price £</b>	74.00	60.00

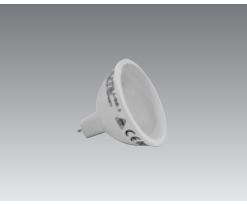
## Bulbs and Batteries

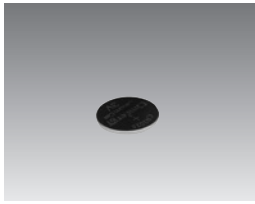
				
Article	<b>Bulb</b> Suitable for GaraMatic 7 and 9 operators Auto Expert	<b>Bulb</b> Suitable for GaraMatic 10 and 20 operators	<b>LED Bulb</b> Suitable for GaraMatic 9 operator	<b>LED Bulb</b> Suitable for GaraMatic 10 and 20 operators
Ref. No.	715	4643	7807	7806
Price £	10.00	13.00	15.00	15.00

			
Article	<b>CR2032 Battery</b> Suitable for wall consoles etc.	<b>A11 Battery</b> Suitable for HSE2 hand transmitter	<b>A23 Battery</b> Suitable for HS2. HSM2. HS4 and HSM4
Ref. No.	4644	2521	2522
Price £	12.00	12.00	12.00



# Touch Up Paint



**Aerosol Spray**  
£ 36.00 ea.



**Touch up Pot**  
£ 8.00 ea.

	<b>Ref. No.</b>	<b>Ref. No.</b>
Burgundy Brown	6851	5387
Golden Brown	6852	3258
Light Ivory (RAL 1015)	7521	7177
Ruby Red (RAL 3003)	6821	2740
Signal Blue (RAL 5005)	6822	2742
Steel Blue (RAL 5011)	6819	3256
Pigeon Blue (RAL 5014)	-	7178
Moss Green (RAL 6005)	6837	2743
Fir Green (RAL 6009)	7328	7180
Anthracite Grey (RAL 7016)	7333	7179
Stone Grey (RAL 7030)	7332	7181
Light Grey (RAL 7035)	7330	7182
Window Grey (RAL 7040)	7329	7183
Clay Brown (RAL 8003)	7335	7185
Terra Brown (RAL 8028)	6818	3255
Jet Black (RAL 9005)	6817	2741
Traffic White (RAL 9016)	6820	3254
Chartwell Green (BS 4800)	7784	7771

# Warranty

Garador products are manufactured to the highest quality standards and leave our factory only after rigorous quality testing. However, if you should have grounds for complaint, this section tells you what our door warranty offers, and how to go about making your claim.

## Warranty Period

The purchaser is granted a warranty covering the safe and reliable function of the Garador garage door for a period of 10 years from the date of purchase. A 5 year warranty applies to springs, wire cables, track rollers, hinges and guide rollers. The warranty period for replacement parts is 12 months or to the end of your existing warranty period on the door, whichever is longer.

In the case of foil-coated timber effect and PVC doors, a warranty of 5 years is granted, for timber and GRP doors a warranty of 2 years is granted on the door panels alone under the terms and conditions specified herein. The door mechanism and steel frame (if applicable) is covered by the 10 year warranty period.

## Performance

During the warranty period we will replace any and all defective parts which can be proved to be attributed to a material or manufacturing fault. We do not accept costs for dismantling and installation nor for carriage.

## Requirements

Warranty claims are only applicable in the country where the parts are purchased. The parts must have been purchased through our authorised distribution channels. The warranty only covers damage to the contract object.

## Garador Installers

Installing of replacement parts can be dangerous and lead to further problems. We would always recommend installation of any replacement part to be carried out by a Recommended Garador Installer. For further details please call us on 01935 443722 or refer to the Garador website.



# GARADOR

*The Garage Door People*

Bunford Lane, Yeovil, Somerset, BA20 2GL  
Tel: (01935) 443722 Fax: (01935) 443744

[www.garador.co.uk](http://www.garador.co.uk)



Garador is the UK's leading manufacturer of garage doors and operators, with an ultra-modern production facility located in Somerset. We use German engineering expertise to produce highly sophisticated doors and operators. By purchasing a Garador product you can be assured of the highest level of quality, safety and security. With a nationwide network of stockists, installers and service technicians we are an ideal partner for your project.