



Labfacility is a major supplier of component parts for temperature sensor manufacture to UK and overseas companies. Our vast stocks ensure immediate despatch of a wide range of components; non-stock items can usually be supplied within a few days.

- ◆ Terminal heads and blocks
- ◆ Closed end protection tubes
- ◆ Pot seals for mineral insulated thermocouples
- ◆ Stainless steel flexible armour
- ◆ Springs for cable strain relief
- ◆ Coiled leads
- ◆ Wall mount housings
- ◆ Thermocouple solder



Certificate No. 4746

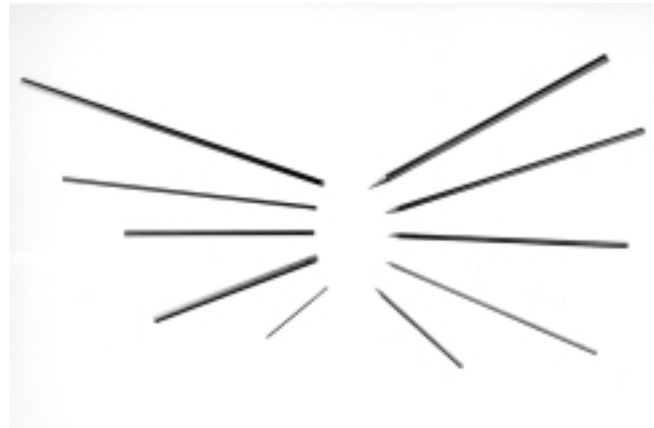
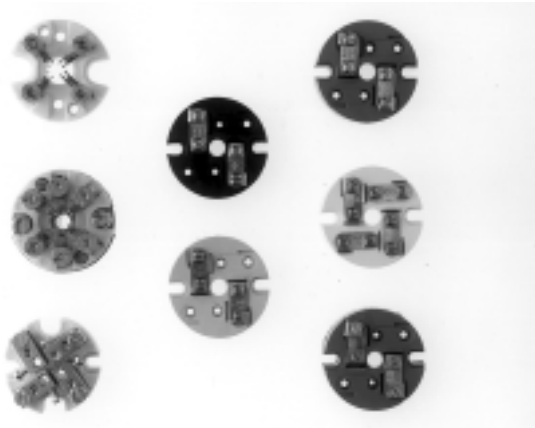
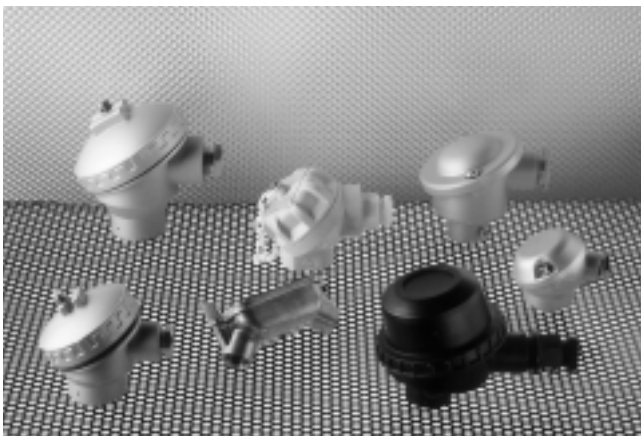

**Plus** Thermocouple connectors and cables, probe installation fittings, thermocouple welding equipment and platinum resistance thermometer sensing resistors described in separate brochures.

**TERMINAL HEADS**

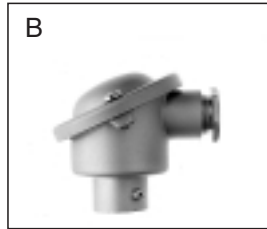

Model	B	KNE	KNS
DIN form	B 43729	—	—
Lid	Retained by 2 screws	Screw type with chain	Screw type with chain
Process Entry	½" BSPP	½" BSPP	½" BSPP
Conduit Entry	PG16 Plated brass gland fitted	M20 x 1.5mm Plated brass gland fitted	M16 x 1.5mm Plated brass gland fitted
Material/ Finish	Cast aluminium/ silver & enamelled	Cast aluminium/ silver & enamelled	Cast aluminium/ silver & enamelled
Max Temp	100°C	170°C	170°C
Terminal block	* —	* —	fitted, 4 way
Order Code	HB-006	HB-013	HB-014
*Accept any blocks described on the next page			

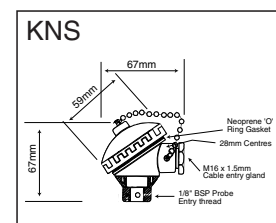
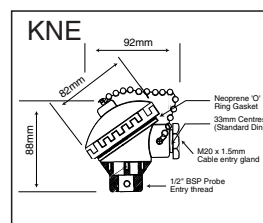
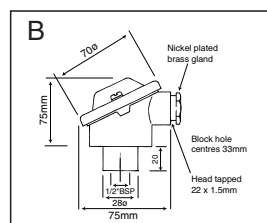

**Accessories for Terminal Heads**

M20 cable gland

PG16 to M20 thread converter for B head

**Order code HA – 001**

**Order code HF – 025**

## TERMINAL BLOCKS

### Ceramic types:

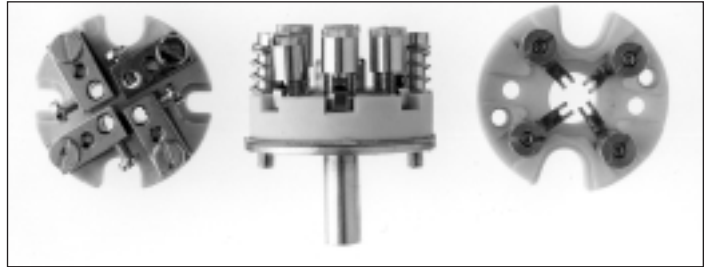
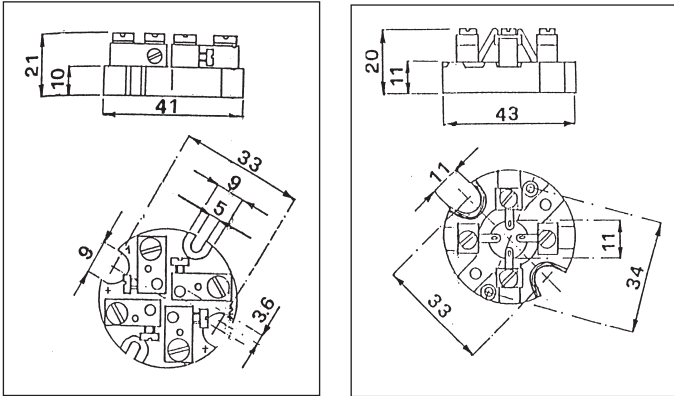

Ceramic, 4 way, screw terminals

Ceramic, 4 way, solder terminals

Ceramic, 6 way, solder terminals

#### Order Code

HT - 040

HT - 041

HT - 044

### Moulded Types:

ANSI colour coded blocks in glass filled thermoplastic for 220°C continuous use. All contact materials in thermocouple alloy (type R in copper / copper alloy).

- Yellow, 2 way, type K
- Black, 2 way, type J
- Blue, 2 way, type T
- Green, 2 way, type R/S
- White, 4 way for PRT

#### Order Code

HT - 051

HT - 053

HT - 052

HT - 055

HT - 054

IEC 584 colours available to special order

Duplex thermocouple blocks available: details on application.

**All DIN B compatible**

**All DIN B compatible**

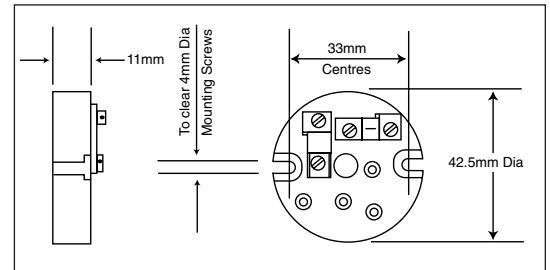
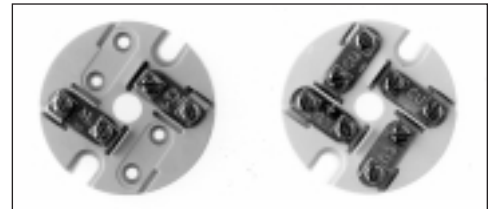

## CLOSED END STAINLESS STEEL TUBES

Round Ended (316 stainless steel). Pressure tested to 150psi.

Outside Dia	Wall thickness	Length	Order Code
2.1mm	0.010"	50mm	SA-100
3mm	0.010"	110mm	SA-101
3mm	0.010"	160mm	SA-102
4mm	0.020"	120mm	SA-105
6mm	0.020"	110mm	SA-108
6mm	0.020"	160mm	SA-109
6mm	0.020"	250mm	SA-110
1/8"	0.010"	110mm	SA-103
1/8"	0.010"	160mm	SA-104
3/16"	0.020"	110mm	SA-106
3/16"	0.020"	200mm	SA-107
1/4"	0.020"	250mm	SA-111

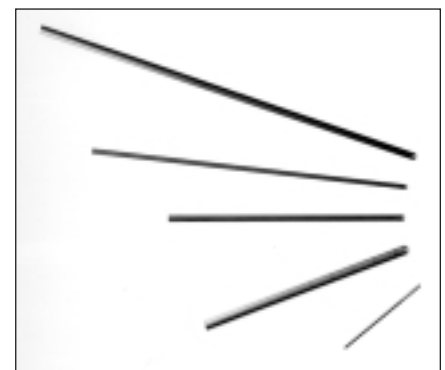

"Pencil" pointed tubes (304 stainless steel) for penetration probes.

Outside diam.	Wall Thickness	Length	Order Code
3mm	0.014"	75mm	SA-201
3mm	0.014"	145mm	SA-202
4mm	0.016"	110mm	SA-203
4mm	0.016"	150mm	SA-204
4mm	0.016"	170mm	SA-205
4.5mm	0.016"	170mm	SA-206
6mm	0.016"	170mm	SA-207

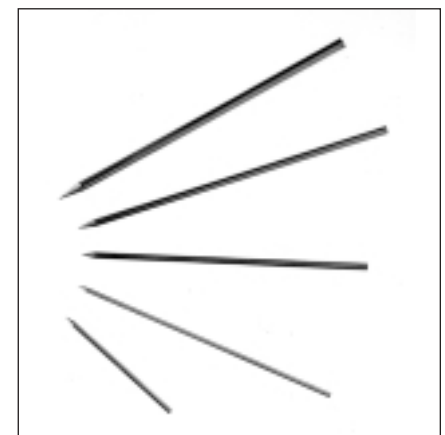

## POT SEALS FOR MINERAL INSULATED THERMOCOUPLES (304 stainless steel)

Type	Dimensions	Order Code
Plain, 1mm	(1/4" O/D x 25mm long)	LW-130
Plain, 1.5mm	(1/4" O/D x 25mm long)	LW-131
Plain, 3mm	(1/4" O/D x 25mm long)	LW-132
Plain, 4.5mm	(9.5mm O/D x 40mm long)	LW-133
Plain, 6mm	(9.5mm O/D x 40mm long)	LW-134
8mm ISO threaded, 1mm	(38mm long)	LW-147
8mm ISO threaded, 1.5mm	(38mm long)	LW-145
8mm ISO threaded, 3mm	(38mm long)	LW-139
8mm ISO threaded, 6mm	(38mm long)	LW-146
1/8" BSP threaded, 1.5mm	(38mm long)	LW-137
1/8" BSP threaded, 3mm	(38mm long)	LW-138

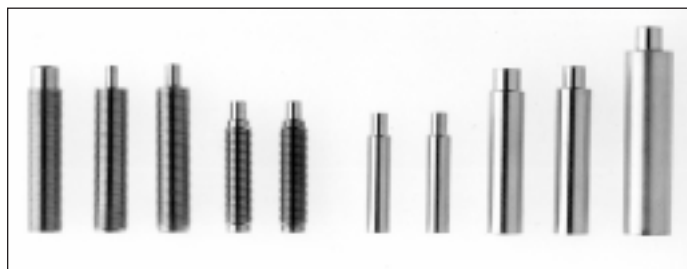

Type	Dimensions	Order Code
1/8" BSP threaded, 4.5mm	(38mm long)	LW-141
1/8" BSP threaded, 6mm	(38mm long)	LW-142

## 'BELL' SPRINGS FOR PROBE CABLE STRAIN RELIEF (HS3 spring steel)

Probe dia.	Length	Order Code
4.5mm	35mm	CA-090
6.0mm	35mm	CA-092

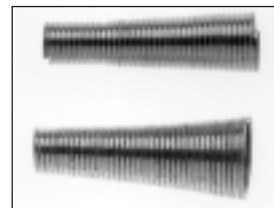

## STAINLESS STEEL ARMOUR (grade 304)

Bore	Outside dia.	Order Code
1/8"	5.18mm	WC-035
3/16"	6.78mm	WC-034
5mm	7.00mm	WC-021



## COILED LEADS, PVC INSULATED

Type	Extension length	Order Code
Type J	1.5m	WJ-088
Type K	1.5m	WK-084
Type T	1.5m	WK-090
4 core copper	2m	WC-017



## WALL MOUNTING BOX FOR AIR TEMPERATURE SENSING

Type	Order Code
Box only (2 part, moulded). (85 x 85 x 30mm)	PA-004
PCB	LW-454
Terminal block for PCB	LW-455



## SOLDER FOR THERMOCOUPLE WIRE

Alloy 450 Tin/  
Lead Silver  
solder.

Order Code
WX - 004



For details of Thermocouple Connectors, Cables, Probe, Installation fittings, Thermocouple Welding Equipment and Platinum Resistance Thermometer Sensing Resistors please refer to separate data sheets available on request.

Specifications, dimensions and availability may be subject to change.