

Solutions with excellence for the Care Home....



ANDWAY
healthcare

2014/15

PRODUCT GUIDE
Care Supplies and Equipment

Our Mission:

'To assist Care Homes in caring' -
by providing a comprehensive range
of Nursing and Hygiene consumable products,
equipment and services.

We will help ensure the smooth running
of your business by providing effective
products, on-time solutions
and professional friendly advice.

'Providing a simple, honest, on-time service
for the Care Home'



Health...

Andway Healthcare is a family owned
company serving the National Health Service,
Hospice, Care Home and Community markets.

The healthy growth of our Company is
based on our determination to provide high
quality products, quickly and efficiently.
Our service is focused on the need to
maintain a good working relationship with our
customers in order to keep your organisation
in good health.

The loyalty of our customer base is an
emphatic endorsement of the level of
service we provide. But we will always
strive to improve our products and services
wherever possible, to ensure that your
needs are fully met, not only now, but for
many years to come.

...care

In order to care for your organisation rightly,
we have a 'best value' policy which requires
that every item stocked is not only of high
quality, but represents consistently good
value. As prices of many items are affected
by the wider economy we produce a separate
price list which is regularly updated with new
products and the latest offers.
Please request your copy.

To reinforce our comprehensive service of
'total care', Andway Healthcare provides a
range of services designed to make your job
as hassle-free as possible. This includes the
servicing and repair of a large range of
equipment, and short or long-term hire.
Please see page 2 for details.

If you do not see what you are looking for in
the catalogue, please call us. It is impossible
to list all the products we supply as new and
additional products are becoming available
almost on a daily basis.

Andway Healthcare Ltd.
Atlantis House
Manse Lane
Knaresborough
HG5 8LF

Tel: 01423 331000
Fax: 01423 332440
Email: sales@andwayhealthcare.org.uk
Web: andwayhealthcare.com



ANDWAY

Healthcare Repair Services

In addition to a full range of products, we offer the following services which are essential to the efficient operation of Care Homes:

PRESSURE SYSTEM REPAIRS

We repair and service ALL makes of pressure relieving mattresses. These repairs can be carried out on your premises but the most cost-effective way (to avoid Engineer call-out costs) is to have the faulty system collected for our in-house examination. We can loan you a replacement system to cover the time that your own system is away. We will also provide an estimate of the repair cost before proceeding with your repair to give you peace of mind about the expense. The replacement loan system is then collected when the repaired system is returned to you. The repair work is warranted for a period of three months.

PATIENT LIFTING HOIST SERVICING AND REPAIRS

We also repair, service and Loler test all makes of patient lifting hoists at your premises. We provide a call-out service for breakdowns, and strive to have an engineer with you within 24 hours of your call (excluding weekends).

HIRING OF PRESSURE RELIEVING ACTIVE SYSTEMS

Alternating pressure relieving systems are available for hire to cover the full range of risk category products. The minimum hire period is one week. Please enquire for our competitive charges for this service. Many Care Homes find the cost-effectiveness of hiring against purchasing a considerable advantage.

HIRING OF PATIENT LIFTING HOISTS

Patient lifting hoists are also available for hire with a minimum hire period of one month. Hoists can be made available for a variety of weight limits to suit the patient requirements. Slings are available but are not hired owing to their relatively low cost and to avoid any danger of cross-infection. Please enquire for our competitive charges for this service.

DECONTAMINATION OF PRESSURE SYSTEMS

A fully equipped laundry facility is available either in conjunction with the repair service or as a separate service, which decontaminates and cleans to our approved standards. The chemical used is certificated against MRSA.

As a result of our policy of continual improvement, we reserve the right to change any product specification without prior notice.

Where 'risk categories' are given these are to the Waterlow scale and are for guidance only.

Measurements may be stated to either the imperial or metric scale. Dimensions etc. are necessarily rounded and approximate within manufacturing tolerances.

Fire Certificates are available for most products.

All business is conducted in accordance with Andway Healthcare standard terms and conditions.

Contents

Nursing Consumables	5
First Aid and Woundcare	17
Hygiene and Catering	23
Paper Products	33
Toiletries	37
Pressure Care Products	41
Moving and Handling Equipment	50
Bedding and Towels	61
Nursing Equipment	69
Furniture	93
Interiors	96
Index	100
Quotation Request Form	104
Service Level Agreement	105
Terms & Conditions	106

Nursing Products

- Disposable Gloves
- Polythene Products
- Patient and Hard Surface Wipes
- Hand Sanitizing Products
- Disposable and Re-Usable Containers
- Needles and Syringes
- Incontinence Care



“ Andway Healthcare sources its nursing products from across the globe enabling us to offer a compact and precise range; meeting the needs of healthcare providers throughout the UK. ”

Disposable Gloves

- A** All gloves are available in Small, Medium and Large
* Add S, M or L to order code

LLPG/* Latex lightly powdered gloves - pk100
LPFG/* Latex powder free gloves - pk100

Medical grade natural latex, sensitive, with high tensile strength. Also available in XS (powder free) and XL (powdered and powder free).

V LPG/* Vinyl lightly powdered gloves - pk100
VLPBG/* Vinyl lightly powdered gloves blue - pk100
VPFG/* Vinyl powder free gloves - pk100
VPFBG/* Vinyl powder free gloves blue - pk100
Medical grade, excellent value, seamless and comfortable to wear. XS & XL sizes available for code VPFG.

SLPFG/* Synthetic powder free gloves - pk100
An economical medical grade alternative to Latex or Nitrile gloves. Also available in XL.

POLYG/* Polythene gloves clear - pk100
POLYGB/* Polythene gloves blue - pk100
Ideal for general purpose use, providing lightweight, touch sensitive protection at an economical price.

NPFG/* Nitrile powder free gloves - pk100
NPFBG/* Nitrile powder free gloves blue - pk100
As soft, supple and comfortable to wear as natural rubber latex but significantly stronger with superior resistance to oil/chemical permeation. Also available in XL.

SPFG/* Sterile latex powder free gloves - 1 pair
Sterile version of SLPFG above.

SSPFG/* Sterile synthetic powder free gloves - 1 pair
Sterile version of SLPFG above.

Polythene Aprons

- B** Hygienic disposable polythene aprons, in dispenser packs. Size 69 x 107cm.

RWA100 Polythene aprons - white - pk100
RBA100 Polythene aprons - blue - pk100
RYA100 Polythene aprons - yellow - pk100
RRA100 Polythene aprons - red - pk100
RGA100 Polythene aprons - green - pk100
SWA100 Supertouch heavy duty aprons - white - pk100
SBA100 Supertouch heavy duty apron - blue - pk100

- C** Disposable polythene aprons on a roll. Size 69 x 107cm.

RWA200 Polythene roll aprons - white - roll 200
RBA200 Polythene roll aprons - blue - roll 200
RYA200 Polythene roll aprons - yellow - roll 200
RRA200 Polythene roll aprons - red - roll 200
RGA200 Polythene roll aprons - green - roll 200
SWA200 Supertouch heavy duty roll aprons - white - roll 200
SBA200 Supertouch heavy duty roll apron - blue - roll 200
For apron roll dispenser see page 24

Overshoes

- D** OS16 Overshoes size 16 - pk100

Oversleeves

- E** 2944 Oversleeves - pk100





Hairnets

A HNB Hairnets - blue - pk100
A simple and convenient aid to infection control

Mobcaps

B MC Mob Caps - pk100
Manufactured from soft, durable, lightweight fabric which prevents the passage of minute particles whilst allowing the scalp to breathe.

Patient Wipes

C CD00 Caredry standard wipes - pk100
30 x 20cm economical wipes for high volume usage, very gentle for use on delicate skin.

CD01 Caredry medium wipes - pk100
30 x 25cm for general wiping applications. Combine strength and softness for everyday use.

CD0028 Caredry large wipes - pk100
33 x 29cm for general wiping applications. Combine strength and softness for everyday use.

CD03 Caredry super wipes - pk100
35 x 33cm multi-purpose durable wipes with excellent absorbency and cleaning ability.

CD04 Caredry air-laid wipes - pk100
30 x 30cm maceratable wipes made from air-laid tissue giving good wet strength and exceptional absorbency.

SL60 Silksoft spunlace wipes - pk60
36 x 27cm premium quality wipes for the ultimate in softness and absorbency

Moist Patient Wipes

D CM300 Caremoist skin wipes (pillow pack) - pk100
25 x 30cm skin cleansing wipes offering an effective alternative to soap and water. Lightly fragranced and alcohol and lanolin free.

E CM370 Caremoist Tub skin wipes - pk200
20 x 22cm skin cleansing wipes with the convenience of a tub container. Lightly fragranced and alcohol and lanolin free.

F CM380 Caremoist Bucket skin wipes - pk150
26 x 30cm skin cleansing wipes in a bucket dispenser. Lightly fragranced and alcohol and lanolin free.

G CM390 Polymoist Mini skin wipes - pk100
13 x 18cm small skin cleansing wipes with the convenience of a tub container. Lightly fragranced and alcohol and lanolin free.

Hard Surface Wipes

H W502 Surfol Maxi alcohol surface wipes - pk200
20 x 22cm disinfection wipes for hard surfaces, containing 70% Isopropanol to instantly eliminate dangerous bacteria.

R410 Probe wipes - pk70
7 x 13cm for sanitising and de-odorising probes and utensils.

4149 Tub wipe dispenser for CM370 and SM02

Skincare Products

A R321 Polyfoam skin cleansing foam - non aerosol
Emollient skin cleansing foam to gently cleanse, deodorise and condition the skin. PH balanced. 200ml pump action dispenser.

B R322 Polyfoam skin cleansing foam refill 1000ml refill

C R323 Care Wash aerosol foam wash
Gentle, soap free emollient skin cleansing foam. PH balanced. 500ml aerosol.

D SEC500 Clinisan wash cream
Containing emollients and moisturisers to cleanse and protect healthy skin. Water repellent to protect from rewetting. 500ml.

E SBA500 Clinisan Body Wash Advance - 250ml
Skin cleanser, hair shampoo and foam bath in one. Contains Chlorhexidine and Tea Tree Oil to help combat bacteria including MRSA and Clostridium Difficile. pH-balanced, lightly fragranced.

F RWM01 Rosebank wash mitt

G PJ225 Petroleum jelly -225g

Hand Sanitizing Products

H 448001 Hydrex surgical scrub 500ml

I 448028 Hydrex surgical scrub 5L

Detergent based solution with emollient. For use as a hand wash/scrub and pre-operative skin preparation.

J CAG50 Cutan alcohol gel pocket size with clip 50ml

K CAG400 Cutan alcohol gel 400ml

L DUCAG39G Cutan alcohol gel with dispenser 1000ml

M CAG392 Cutan alcohol gel refill cartridge 1000ml

For the rapid disinfection of physically clean hands, Cutan alcohol gel is formulated with ethyl alcohol for optimum effectiveness and low odour. It is quick and easy to use, popular with staff, and can significantly improve hygiene levels.

N PAG60 Purell alcohol gel pocket size 60ml

O PAG350 Purell alcohol gel pump dispenser 350ml

P GJ2156-08 Purell alcohol gel refill cartridge 1000ml

PWB350 Purell wall bracket for 350ml

Q GJ9608-24 Retractable clip for Purell

Highly effective and economical gel for hand disinfection, Purell alcohol gel is formulated with Ethanol and Isopropanol, and contains no perfume or colouring.

R ALCA500 Alcagel alcohol gel 500ml

S ALCA5L Alcagel alcohol gel 5 litre

T ALCA500WD Alcagel alcohol gel 500ml wall dispenser

U ALCA500HD Alcagel 500ml hanging dispenser
Instant hand and surface sanitiser that kills common germs within 15 seconds of contact.



Sacks

SSL501 Soluble strip laundry sacks - red
Durable sacks designed to be self-opening during the wash process. Size 18" x 28" x 30".

NLB* Nylon laundry sack
* Colours: white, blue, red, green, yellow.

A A wide range of contract quality refuse sacks for all requirements.

- RBS1504** Black sacks 18" x 29" x 34" 150g
- RBS1609** Heavy duty black sacks 18" x 29" x 39"
- CWS** Clinical waste sacks 29" x 34"
- GRS200** Green refuse sacks 18" x 29" x 39"
- YRS** Yellow refuse sacks
- SYS** Small yellow self seal bags
- TB** Tiger bags
- PBL** Pedal bin liners
- PBL/LF** Fragranced pedal bin liners - lemon
- SBL** Swing bin liners
- SBL/LF** Fragranced swing bin liners - lemon
- SNS** Scented nappy sacks

Sterile Procedure Packs

- B CP Catheter pack**
 - 3 non-woven swabs
 - 1 polythene sterile field
 - 1 kidney dish
 - 1 gallipot 60ml
 - 8 non woven balls large
 - 1 polythene sterile field folded
 - 2 blue plastic forceps
- C DP/S Dressing pack - small**
 - 1 polypropylene tray
 - 5 non-woven swabs
 - 1 dressing towel
 - 1 yellow disposable bag
 - 1 field wrap
 - 1 gallipot 60mm
 - 5 large cotton wool balls
- D DP/M Dressing pack - medium**
 - 1 polypropylene tray (2 integral gallipots)
 - 5 non-woven swabs
 - 5 large cotton wool balls
 - 4 blue plastic forceps
 - 1 dressing towel
 - 1 yellow disposable bag
 - 1 field wrap
 - 1 red bag tie

- E OHP Oral hygiene pack**
 - 1 corrugated box
 - 2 non-woven swabs
 - 10 foam star swabs
 - 1 tongue depressor
 - 1 yellow disposable bag
 - 1 red bag tie

- F RCRFT002 Readyfield woundcare dressing pack - option 2**
 - 1 Readyfield tray small
 - 1 60ml gallipot
 - 2 non-woven swabs
 - 1 dressing towel
 - 1 yellow disposable bag
 - 1 Readyfield insert
 - 1 pair of powder-free gloves

Sterile Procedure Packs (cont)

- A ECP Eye care pack**
 - 1 polypropylene tray (2 integral gallipots)
 - 6 small cotton wool balls
 - 1 eye dressing 8x6cm
 - 1 dressing towel
 - 1 field wrap
 - 1 yellow disposable bag
 - 5 non-woven swabs
 - 1 red bag tie

- B AZ40-01 Tracheotomy tube holders with foam neck band Pk25**
- C CWB/5 Cotton wool balls**
- D STF Sterile forceps**

Swabs

- E OFS250 Oral foam swabs - pk250**
Dry foam swabsticks for use with mouthwashes.
- F LGS/75 Lemon and glycerine swabs - pk90**
100% cotton tips on durable white polypropylene handles. Refreshing citrus taste of lemon, to stimulate saliva flow, combined with glycerine to lubricate and soften tissues. Supplied in sachets of 3 swabs.
- G PRIS Pre-injection swabs - pk100**
Alcohol wipes for pre-injection cleansing.

Needles and syringes

- H Sterile needles in packs of 100**
 - GN21** Green needles 21G
 - BKN22** Black needles 22G
 - BN23** Blue needles 23G
 - ON25** Orange needles 25G
- I Luer Slip syringes**
 - SLS1** 1ml syringe
 - SLS2** 2ml syringe
 - SLS5** 5ml syringe
 - SLS10** 10ml syringe
 - SLS20** 20ml syringe
 - SLS50** 50ml syringe
- J Catheter tip syringe**
 - SCT50** Catheter tip syringe
- K Luer Lock syringes**
 - SLL5** 5ml syringe
 - SLL10** 10ml syringe
 - SLL20** 20ml syringe
 - SLL50** 50ml syringe

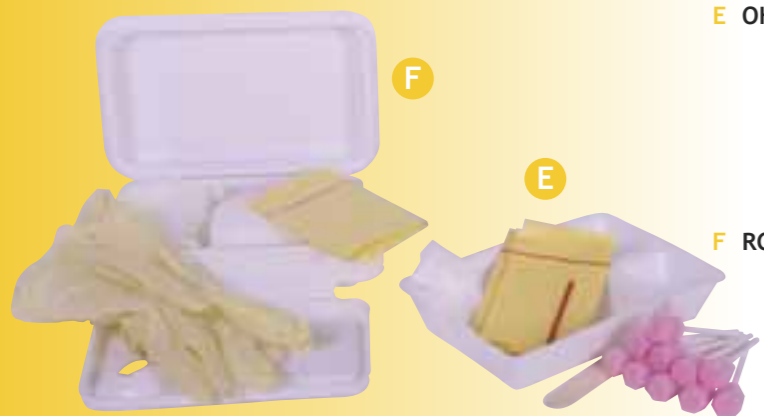
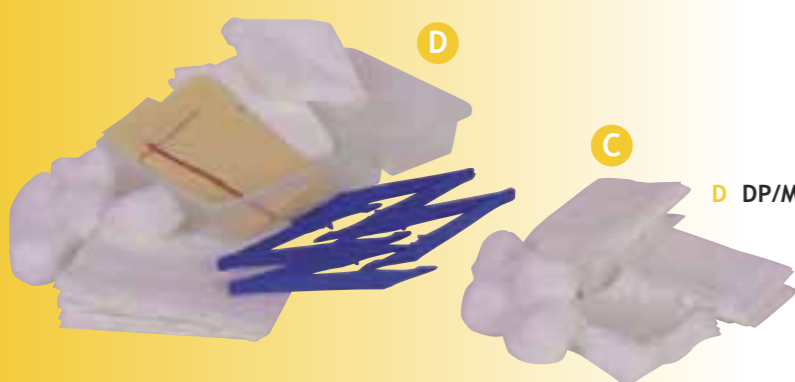
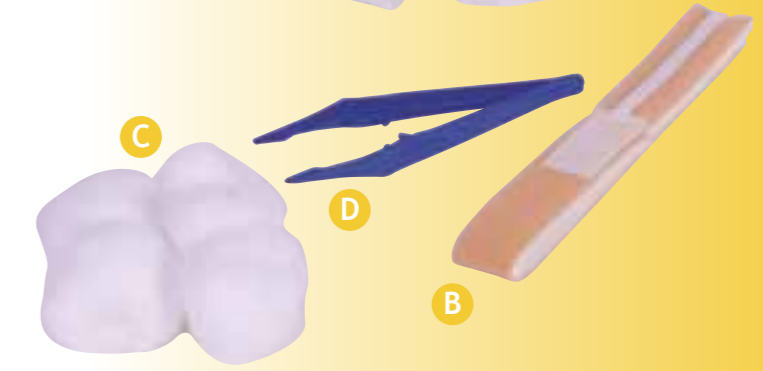

Needles and syringes (cont)

Infusion sets

- A IS25G Flo Safer winged infusion set 25G
- B UN998606 Mediflex infusion set
- C H9P30310014 Butterfly winged infusion needle 21G

- D AS5971 Minilet lancets
- AS5977 Minilet lancing device

- E VS367263 Blood collection set 23G

Disposable Containers

- F MM30 30ml medicine measures - pk80
 - G MM60 60ml medicine measures - pk25
- Transparent measures without lids

- UN273 Medicine spoon 5ml - pk250

- H DDPL Disposable denture pots with lids - pk50

- I DSPL Disposable sputum pots with lids - pk50

- J DGPB Disposable general purpose bowl

- K DKD Disposable kidney dish

Re-usable Containers

- L SG60 Sterile Gallipot 60mm

- M DNT Re-usable denture cup with hinged lid

- N KD150 Re-usable kidney dish 150mm
- KD200 Re-usable kidney dish 200mm
- KD250 Re-usable kidney dish 250mm
- KD300 Re-usable kidney dish 300mm

- O VB300 Re-usable vomit bowl
- Graduated, with handle.

- P UN252 Mid stream urine sample bottle

- Q IT2015 Instrument tray 200 × 150 × 51mm
 - IT3025 Instrument tray 300 × 250 × 52mm
 - IT4030 Instrument tray 420 × 305 × 75mm
- Instrument trays with strengthened sides and ribbed bases to improve steam circulation.

Emergency Accessories

- A SC12 Suction catheter 12CH 60cm
 - SC14 Suction catheter 14CH 60cm
 - SC16 Suction catheter 16CH 60cm
- Sterile suction catheters, individually wrapped.

- B SCFC12 Suction catheter 12CH 48cm with flow control
 - SCFC14 Suction catheter 14CH 48cm with flow control
 - SCFC16 Suction catheter 16CH 48cm with flow control
- Sterile suction catheters with flow control, individually wrapped.

- C W95041 Sterile suction catheter connector

- D YSC Yankeur sucker with control
- Sterile disposable Yankeur suckers with fingertip control

- E AAW* Adult airway
- *Specify size 1, 2, 3 or 4

- F W4442 Emergency manual resuscitator
- Made from 100% latex-free synthetic material with textured grip. Complete with mask, patient valve, reservoir bag and oxygen driveline.

- G W46081 Res-Q-Vac manual aspirator

Masks and Tubing

- H 184 Resuscitator shield

- I W4453 CPR masks
- With one-way valve and directional diaphragm - allows no backflow of air or contaminants.

- J NFMK Nebuliser face mask kits with tubing

- D1043 Adult oxygen mask and tubing
- K D1040 Adult oxygen mask

- L W55397 Oxygen / Nebuliser tubing
- UN740 Suction bubble tubing 5mm (30m)

- M D1012 Nasal cannula with tubing

- N W4605 Silicone tubing 2m

- O PFM Paper face mask

- P DFM Disposable face mask

Test Strips

- Q 10SL Combi-screen 10SL Urine test strips - pk100
- Urinalysis test strips for glucose, ketones, protein, pH, blood nitrite, leucocytes, urobilinogen, bilirubin, SG and ascorbic acid. Equivalent to Labstix/Multistix.





Incontinence Care - Shaped Pads

- A** Small shaped pads with good absorption and retention capacity, and odour neutralizer. Anatomical shape with 3 adhesive bands providing perfect fit to underwear. ISO 11948-1 absorption capacity in brackets.
- 2821716P Indasec Mini (626ml) - Pk20
 - 2821714P Indasec Midi (696ml) - Pk14
 - 2821724P Indasec Maxi (1123ml) - Pk24

- B** Economical shaped pads with good absorption and comfort levels. ISO 11948-1 Absorption capacity in brackets
- LCFM4111 Classic Form Regular blue (1300ml) - Pk125
 - LCFM4111P Classic Form Regular blue (1300ml) - Pk25

- C** Shaped pads with double absorbent core and non-woven layer enriched with aloe vera. ISO 11948-1 absorption capacity in brackets.
- 2834212 Indasform Extra blue (1705ml) - Pk168
 - 2834212P Indasform Extra blue (1705ml) - Pk28
 - 2834216 Indasform Super yellow (2253ml) - Pk168
 - 2834216P Indasform Super yellow (2253ml) - Pk28
 - 2834222 Indasform Superplus green (2846ml) - Pk112
 - 2834222P Indasform Superplus green (2846ml) - Pk28
 - 2834226 Indasform Maxi lilac (3063ml) - Pk112
 - 2834226P Indasform Maxi lilac (3063ml) - Pk28

Incontinence Care - All-in-ones

- D** All-in-one elastic pads for patients with reduced mobility suffering heavy incontinence. ISO 11948-1 absorption capacity in brackets.
- 2834114 Indaslip Plus 1 small (1849ml) - Pk112
 - 2834114P Indaslip Plus 1 small (1849ml) - Pk28
 - LCFT6211 Classic Fit Plus medium (2350ml) - Pk104
 - LCFT6211P Classic Fit Plus medium (2350ml) - Pk26
 - 2834116 Indaslip Plus 2 medium (2733ml) - Pk112
 - 2834116P Indaslip Plus 2 medium (2733ml) - Pk28
 - 2834132 Indaslip Super 2 medium (3517ml) - Pk84
 - 2843132P Indaslip Super 2 medium (3517ml) - Pk21
 - LCFT6311 Classic Fit Plus large (2350ml) - Pk104
 - LCFT6311P Classic Fit Plus large (2350ml) - Pk26
 - 2834122 Indaslip Plus 3 large (3353ml) - Pk112
 - 2834122P Indaslip Plus 3 large (3353ml) - Pk28
 - 2834136P Indaslip Super 3 large (4310ml) - Pk84
 - 2843136 Indaslip Super 3 large (4310ml) - Pk21
 - LCFT6411 Classic Fit Super x-large (2700ml) - Pk60
 - LCFT6411P Classic Fit Super x-large (2700ml) - Pk20

- E** LCFT7211 Supreme Fit regular plus medium - Pk104

Incontinence Care - Bed Pads

- F** Disposable bed pads for night-time peace of mind.
- IS5775 Inco sheet 5-ply 57 x 75cm - Pk200
 - LFBD8211 Tyco bed pad 60 x 60cm - Pk140
 - LFBD8211P Tyco bed pad 60 x 60cm - Pk35
 - LFBD8411 Tyco bed pad 60 x 90cm - Pk140
 - LFBD8411P Tyco bed pad 60 x 90cm - Pk35

Incontinence Care - Pull-up Pants

- G** Lille Supreme protective undergarments for moderate incontinence. Designed for comfort and ease of use. Absorption capacity in brackets.
- LSPU0211 Lille Supreme medium (1260ml) - Pk112
 - LSPU0211P Lille Supreme medium (1260ml) - Pk28
 - LSPU0311 Lille Supreme large (1310ml) - Pk112
 - LSPU0311P Lille Supreme large (1310ml) - Pk28
 - LSSL0011 Lille Supreme Slip On 1 size (1052ml) - Pk104
 - LSSL0011P Lille Supreme Slip On 1 size (1052ml) - Pk26

Incontinence Care - Net Pants

- A** Net pants in 5 sizes for the perfect fit.
- LNP/S Lycra net pants small (yellow) - Pk5
 - LNP/M Lycra net pants medium (blue) - Pk5
 - LNP/L Lycra net pants large (brown) - Pk5
 - LNP/XL Lycra net pants extra large (green) - Pk5
 - LNP/XXL Lycra net pants xx large - Pk5

Incontinence Accessories

- B** UML1000 Cyclops male urinal
- C** USP1200 Male urinal with Tedi top
- D** UF1000 Cygnet female urinal
- E** SPN Slipper bed pan
- F** FPN Favorit fracture bed pan Adult slipper pan with handle and lid.
- G** CBL Commode bucket and lid (round)
- H** UN230 Free standing catheter bag stand
- I** 783680 Net leg holder for catheter bag - small
- I** 783686 Net leg holder for catheter bag - medium

Disposable Incontinence Accessories

- DBP** Disposable bed pan
- J** DMU Disposable male urinals
- K** DCP Disposable commode pan
- L** DFU Disposable female urinal bottle
- M** VS8/50 Vernagel sachets 8gm - Pk50
- N** 854337 Sangenic Easiseal standard disposal unit
- N** 854342 Sangenic Easiseal maxi disposal unit
- O** 854338 Sangenic refill cassettes - Pk6



Feeding Products

A comprehensive selection of beakers, cups, lids and ward products suitable for nursing, rehabilitation and elderly care.

- A BFC250 Feeder beaker**
Graduated feeder beaker 250ml
- B BFH250 Feeder beaker with 2 handles**
Graduated feeder beaker 250ml, with easy grip handles
- C BNS Narrow spout lid**
Suitable for BCF250 and BFH250, with 4x4mm spout hole
- D BMS Medium spout lid**
Suitable for BCF250 and BFH250, with 7x4mm spout hole
- E BWS Wide spout lid**
Suitable for BCF250 and BFH250, with 13x8mm spout hole
- F 114PP Long spout lid**
Suitable for BCF250 and BFH250, with extended spout and 13x8mm spout hole
- G 117PP Feeder beaker with 2 handles and lids**
260ml beaker with 2 tight fitting translucent lids. The design of the lid allows the use of a straw or the spout provided.
- H PH6135 One handled mug with 2 lids**
- I TFB Teapot type feeder beaker 250ml**
Teapot style beaker with 8mm spout
- J TBC Transparent beaker 280ml**
- K JGL1000 Graduated jug with lid 1000ml**
- L JG500 Jug without lid 500ml**
- M AA5662W Plate guard**
- N LST Bedside locker set**
Locker set consisting of TBC transparent beaker, JGL1000 jug, and 270 x 150mm tray.

Miscellaneous Patient Care

- O 3001 Adult wristlet identification band - Pk100**
- P RML506 Sterile wooden spatula - Pk10**
- Q AA9934 Pill crusher and dispenser**
- R UN273 Medicine spoon 5ml - Pk250**

First Aid & Woundcare

First Aid Kits

Eye Care

Plasters, Adhesive Tape and Bandages

Sterile and Non Sterile Dressings

Burn Relief



“ A range designed to provide for the workplaces health & safety requirements ”



First Aid Kits

HSE First aid kits complying with all current requirements. Standard kits include washable plasters, and Food Hygiene kits include blue detectable plasters. Kit refills do not include wall hanging brackets.

- A FHSE10** Standard 10 person kit
 - 782** Standard 10 person food hygiene kit
 - RFHS10** Standard 10 person kit refill
 - 783** Standard 10 person food hygiene kit refill
- 10 person kit contains:
20 plasters, 6 HSE dressings 12x12cm, 2 HSE dressings 18x18cm, 2 No 16 eyepads, 4 triangular bandages, 6 antiseptic wipes, pair of gloves, 6 safety pins, wall hanging bracket, leaflet.
- B FHSE20** Standard 20 person kit
 - 786** Standard 20 person food hygiene kit
 - RFHS20** Standard 20 person kit refill
 - 787** Standard 20 person food hygiene kit refill
- 20 person kit contains:
40 plasters, 9 HSE dressings 12x12cm, 3 HSE dressings 18x18cm, 4 No 16 eyepads, 6 triangular bandages, 10 antiseptic wipes, 2 pairs of gloves, 12 safety pins, wall hanging bracket, leaflet.
- C FHSE50** Standard 50 person kit
 - RFHS50** Standard 50 person kit refill
- 50 person kit contains:
60 plasters, 12 HSE dressings 12x12cm, 4 HSE dressings 18x18cm, 6 No 16 eyepads, 8 triangular bandages, 20 antiseptic wipes, 3 pairs of gloves, 12 safety pins, wall hanging bracket, leaflet.

MO26 Moto first aid kit
Contains: 20 plasters, fabric strip, Roll of plaster tape, No 8 dressing, No 9 dressing, No 16 eye pad, triangular bandage, 2 WOW bandages, conforming bandage, 15g cotton wool, 4 antiseptic wipes, 20ml eyewash pod, pair of scissors, 6 safety pins, 2 sick bags and gloves, Antiseptic cream, Plastic fingerstall, Wall hanging bracket, Motokit sticker, First aid leaflet.

D BKN01 Burns kit
Contains: Burnsoothe dressing 20x20cm, 2 burnsoothe dressings 10x10cm, 3 burnsoothe gel sachets, 2 paraffin gauze dressings, 2 rolls of plaster tape, 2 conforming bandages, 4 low adherent dressings, 2 pairs of vinyl gloves, pair of Tuff-cut scissors, 6 safety pins, First-aid leaflet.

E BHNG01 Body fluids spillage kit - 2 applications
Contains: 2 disinfectant sprays, 2 absorbent powders, 2 pairs of oversleeves, 2 pairs of gloves, 2 aprons, 2 scoops and scrapers, 2 hazard bags, 4 bonded wipes, 2 disinfectant wipes.

448 Body fluid spillage kit refill - 2 refills

F CAPK20 Catering first aid kit
Contains: 100 blue detectable plasters, blue plaster tape, blue cohesive tape, 6 blue vinyl gloves, 5 blue fingerstalls.

G 969 Deluxe eye wash station
Contains: 2 500ml bottles, 2 No 16 eyepads, wall mounting bracket.

H 485 Mirror eye wash station
Contains: 2 x 500ml bottles





Eye Care Products

- A 329 Focus eyewash solution 500ml
- B 108 Eye bath
- C NAS Normasol antiseptic solution
- D W2137 Disposable pen torches

E Sterile Plasters

- FEAP18 Assorted fabric plasters - Pk100
- TEWP28 Assorted waterproof plasters - Pk100
- BEPD46 Fingertip blue detectable plasters - Pk50
- BEPD48 Assorted blue detectable plasters - Pk100
- TEWP26 Fingertip waterproof plasters - Pk100
- SEP Sterile eye pad 85 x 55mm - Pk20

F Adhesive Tape and Strips

- FPT250 Finepore adhesive tape 2.5 x 9.1cm
- FPT500 Finepore adhesive tape 5 x 9.1cm
- WCS755 Wound closures 3 x 75mm - Pk5
- WCS752 Wound closures 6 x 75mm - Pk5
- SEAB25 Elastic adhesive bandage 2.5cm x 4.5m
- 670900 Mepore adhesive dressing 9 x 10cm - Pk50
- 671000 Mepore adhesive dressing 9 x 15cm - Pk50

G Bandages

- BDCR05 Crepe bandage 5cm x 4m
- BDCR75 Crepe bandage 7.5cm x 4m
- BDCR10 Crepe bandage 10cm x 4m
- BDCR15 Crepe bandage 15cm x 4m
- BDC005 Conforming bandage 5cm x 4m
- BDC075 Conforming bandage 7.5cm x 4m
- BDC010 Conforming bandage 10cm x 4m
- BO52 Triangular bandage 95 x 134cm
- BO19 Triangular bandage - Sterile 95 x 134cm

A Sterile Dressings

- NAD005 Low adherent dressing 5 x 5cm
- NAD075 Low adherent dressing 7.5 x 7.5cm
- NAD010 Low adherent dressing 10 x 10cm
- SGS555 Sterile gauze swabs 8 ply 5 x 5cm - Pk5
- SGS575 Sterile gauze swabs 8 ply 7.5 x 7.5cm - Pk5
- SGS510 Sterile gauze swabs 8 ply 10 x 10cm - Pk5
- NWSS50 Sterile non-woven swabs 5 x 5cm - Pk5
- NWSS75 Sterile non-woven swabs 7.5 x 7.5cm - Pk5
- NWSS10 Sterile non-woven swabs 10 x 10cm - Pk5
- SURG/8 Surgipads 40 x 20cm - Pk8

Non-sterile Dressings

- GAZ855 8 ply gauze swabs 5 x 5cm - Pk100
- B GAZ877 8 ply gauze swabs 7.5 x 7.5cm - Pk100
- GAZ810 8 ply gauze swabs 10 x 10cm - Pk100
- NWS450 4 ply non-woven swabs 5 x 5cm - Pk200
- NWS475 4 ply non-woven swabs 7.5 x 7.5cm - Pk200
- NWS410 4 ply non-woven swabs 10 x 10cm - Pk200
- C 356 Non woven adhesive dressing 6 x 7cm - Pk25
- 357 Non woven adhesive dressing 8 x 8.6cm - Pk25
- 358 Non woven adhesive dressing 8 x 10cm - Pk25
- 359 Non woven adhesive dressing 8 x 15cm - Pk25

Burn Relief Products

- D KSP070 Kooldown spray skin coolant 70ml
- E BSH125 Hydrogel burn relief gel 125ml
- F 136 Koolaburn finger wrap
- G 336 Koolaburn arm wrap





Cotton Wool

- A 5957 Large cotton wool balls - Pk200
- B AVM3533 Large sterile cotton wool balls - Pk5
- C CWR500 Cotton wool roll 500g
- D 664 Gamgee gauze and cotton tissue 500g

Scissors

- E UN601B Disposable scissors - blunt/blunt
- F UN601S Disposable scissors - sharp/sharp
- G UN601BS Disposable scissors - blunt/sharp
- H UN602BS Sterile disposable scissors
- I UN604 Disposable scissors
- J TCS Tuff Cut scissors
- K SB/B S/Steel dressing scissors blunt/blunt
- SB/S S/Steel dressing scissors blunt/sharp
- SS/S S/steel dressing scissors sharp/sharp

Miscellaneous

- L STF Sterile forceps
- M SS1424 Medical probe
- N SSC/100 Sterile stitch cutters - Pk100
- O SDS10 Sterile disposable scalpels - Pk10
- P CC50 Centrimide cream 50g
- Q SB5 Sharps bin 5 litres
- SB7 Sharps bin 7 litres
- 944 Sharps kit
- R W2147 Tourniquet quick release
- S 206 Antiseptic alcohol-free wipes - Pk50 Individually wrapped



Hygiene & Catering

- Air Fresheners
- Dishwashing and Laundry Items
- Household Products
- Kitchen Cleaners
- Mopping Products
- Plastic Bags
- Soaps
- Dispensers
- Cloths
- Floor and Carpet Care



“ Our branded ‘Atlantis’ product range is well known for performance, quality and value. Our products ensure a perfect clean each time. ”

Air Freshener

- A** CCAF/T Classic Cranberry air freshener trigger spray 750ml
- B** CCAF/5 Classic Cranberry air freshener 5L refill

- C** PPA/T Perfect Peach air freshener trigger spray 750ml
- D** PPA/5 Perfect Peach air freshener 5L refill

- AAON/T** Atlantis Air air and fabric trigger spray 750ml
- E** AAON/1L Atlantis Air air and fabric freshener 1L
- F** AAON/5L Atlantis Air air and fabric freshener 5L
A fast acting odour neutraliser with lemon fragrance, for use on any surface.

- G** SPD742 Refresh fabric freshener 750ml
Odour neutraliser for use on fabrics or as an air freshener

- H** OFPP/T O-Fresh air freshener pot pourri trigger spray 500ml
- I** OFPP/5 O-Fresh air freshener pot pourri 5L refill
- J** OFHS/T O-Fresh air freshener honeysuckle trigger spray 500ml
- K** OFHS/5 O-Fresh air freshener honeysuckle 5L refill

- L** AAF/SF Insette Spring Flower aerosol air freshener 300ml
- AAF/SR Insette Summer Roses aerosol air freshener 300ml
- AAF/LZ Insette Lemon Zest aerosol air freshener 300ml
- AAF/WB Insette Wild Berry aerosol air freshener 300ml
- AAF/NB Insette Natural Breeze aerosol air freshener 300ml

- M** M MAX2 Maxispray dispenser starter pack
With 2 refills. An automatic air freshener system with programmable dispenser and a range of luxury French fragrances. Refills will fit all similar dispensers.
- N** MAXC Carissima refill - 250ml
Sensual, floral and fruity fragrance
- MAXD Davana refill - 250ml
Warm, fruity and subtle fragrance
- MAXE Eau Essentielle refill - 250ml
Basil, bergamot and lemon fragrance
- O** MAXF Fruitnat refill - 250ml
Fruit bouquet with coconut, passion fruit and grapefruit fragrance
- MAXM Mistral refill - 250ml
Citrus and fruity fragrance
- MAXP Palma refill - 250ml
Marine harmony with amber and musk fragrance
- MAXS Plastic spacer - for use with small cans

- P** 151030 Ambi Pur plug in air freshener - Harmony Vanilla Lily
- 151038 Ambi Pur refill - Harmony Vanilla Lily
- 151066 Ambi Pur plug in air freshener - Spring orchard
- 151064 Ambi Pur refill - Spring orchard

- Q** FWK Fly and wasp killer - aerosol

Dishwasher Products

- R** MLD/5 Machine liquid detergent 5L
- MLD/10 Machine liquid detergent 10L
- S** MLD/20 Machine liquid detergent 20L

- T** MLRA/5 Machine liquid rinse aid 5L
- U** MLRA/10 Machine liquid rinse aid 10L
- MLRA/20 Machine liquid rinse aid 20L

- V** DISHP5 Dishwasher powder 5kg
- W** DISHP144 Dishwasher tablets - Pk144

- X** DISHTAN/10 Dishwasher tannin remover 10kg
- Y** DISHS Dishwasher salt 25kg
- Z** CGW/5 Cabinet glasswash 5L
- AA** PBLC/5 Beer line cleaner 5L

Auto dose systems are available for dishwashers - please enquire.





Bleach

- A BL5/5 Bleach 5L
- B TB/1 Thick bleach 1L
- C TB/5 Thick bleach 5L
- D BT Bleach/chlorine tablets - Pk200
- E CPT Chloride Plus tablets - Pk100

Disinfectant

- F GPD/5 Green Pine disinfectant 5L
- G FD/5 Floral disinfectant 5L
- H AD/5 Antiseptic disinfectant 5L
- I DO750 Dettol Original antiseptic 750ml
- J ZO200 Zoflora concentrated disinfectant 200ml

Floor & Carpet Cleaners

- K PFG/5 Pine floor cleaning gel 5L
- L LFG/5 Lemon floor cleaning gel 5L
- M ECS/5 Extract carpet shampoo 5L
- N SSSRT Spot and stain remover 750ml
Ready to use carpet and upholstery spot and stain remover
- O TO32 Odour digester 750ml
Biological odour neutraliser
- P 059412 Anti foam de-foamer additive 5L

Glass Cleaner

- Q GGC/5 Gleaming glass cleaner 5L
- R GGC/T Gleaming glass cleaner trigger spray
- S SC Shower Clear 750ml
Shower cleaner

Hard Surface Cleaners

- T BC/5 Bactericidal hard surface cleaner 5L
Food safe, non-tainting
- U LHSC/5 Lemon hard surface cleaner 5L
- V SWS/5 Spray and wipe sanitizer 5L
- W SWS/T Spray and wipe sanitizer trigger spray 750ml
A hard surface cleaner and sanitizer. Non-tainting and kills MRSA.
- X TC/5 Triple clean 5L
A hard surface cleaner which cleans and sanitizers. Kills MRSA.
- Y TC/T Triple clean trigger spray 750ml
A hard surface cleaner which cleans and sanitizers. Kills MRSA.
- Z SPSP/16 Pink sanitizing powder 10kg
- OSWC/5 O-San washroom cleaner 5L
- OSWC/T O-San washroom cleaner trigger spray 500ml
Apple fragrance washroom cleaner, cleans and sanitizes, kills MRSA.
- AA GPDG/5 General purpose de-greaser 5L
Removes grease, fat and oil from hard surfaces. Odourless and suitable for food preparation areas.
- AB SL/5 Sanitizing liquid 5L
Concentrated cleaner for most hard surfaces. Kills most common bacteria. Odourless and suitable for food preparation areas.
- AC SSL/5 Sterisol sanitizing liquid 5L
Suitable for catering equipment, work surfaces, freezers and fridges.
- AD CO60 Cream cleaner 500ml
- AE CD/5 Descaling liquid 5L
Removes limescale from automatic dishwashers and glasswashers.
- AF 031.501 Suma D10 bac-concentrate 1.5L
- 034.501 Suma D2 Multi concentrate 1.5L
- 030.505 Suma D1 1.5L
- AG JF005 Jeyes Fluid 5L
Outdoor strong disinfectant for general disinfection.

Laundry Products

- A BLL/5 Atlantis biological laundry liquid 5L
- B BLL/10 Atlantis biological laundry liquid 10L
- BLL/20 Atlantis biological laundry liquid 20L
- C NBLL/5 Atlantis non biological laundry liquid 5L
- NBLL/10 Atlantis non biological laundry liquid 10L
- D NBLL/20 Atlantis non biological laundry liquid 20L
- E AELD/5 Ariel essential laundry detergent 5L
- F LDL Atlantis laundry de-stain liquid 10L
- G FS/5 Atlantis fabric softener liquid 5L
- FS/10 Atlantis fabric softener liquid 10L
- FS/20 Atlantis fabric softener liquid 20L
- H LUFS Lenor ultra fabric softener 5L
Autodose systems are available for laundry machines - please enquire.
- I BLP/10 Atlantis biological laundry powder 10kg
- J NBLP/10 Atlantis non biological laundry powder 10kg
- K AR96 Ariel non-biological laundry powder 9.6kg
- L DA114 Daz biological laundry powder 120wash 11.4kg
- M AQDB Aquados biological laundry sachet - Pk100
- N AQDNB Aquados non-biological laundry sachet - Pk100
- O LDP/10 Laundry de-staining powder 10kg
- P SSR500 Shout stain remover - trigger 500ml

Soap Cartridges

- Q 061.041 Tork premium soap cartridge 1L
- R 061.151 Lotus Spray soap cartridge 800ml
- S 061.005 KC Everyday hand cleanser soap cartridge 1L
- 061.007 KC Antiseptic hand cleanser soap cartridge 1L
- T 061.015 Soft Care fresh soap cartridge (H1) 800ml
- U 061.018 Soft Care bac soap cartridge (H4) 800ml
- V 060.343 Deb Flora Free mild lotion handwash 1L
- 061.017 H4 Soft Care bac soap cartridge 800ml
- W CUF39P Cutan foaming soap cartridge 1L
- CUG39J Cutan gentle wash soap cartridge 1L

Soap Dispensers

- 061.076E Flora Free sanitiser dispenser 1L
- X 061.076A Flora Free 1000 skin sanitiser dispenser 1L
- Y 061.150 Lotus spray soap dispenser 500mg
- 4LR Modular bulk top-up soap dispenser
- CUT013 Cutan green dispenser 1L
- Z DGW39P Cutan gentle wash dispenser 1L
- DAG39R Cutan alcohol gel dispenser 1L
- AA DFS39B Cutan foaming soap dispenser 1L
- DVS39S Cutan visitors soap dispenser 1L
- AB 06111RW Tork soap dispenser 1L
- AC GJ2189 Gojo NXT space saver soap dispenser 1L



Soap & Barrier Products

- A PHS/5 Pearl hand soap perfumed 5L
- B LS049 Superfine handwash pump dispenser
- C BHS/5 Bac hand soap non perfumed 5L
- BHS/250 Bac hand soap non perfumed 250ml
- GJ8150 Gojo Hand Medic barrier cream 200ml
- BMS/72 Buttermilk soap - Pk72
- D SS Simple bath soap 2 bars
- BS100 Bath soap 100g
- E BW/6 IL softening bodywash 250ml

Toilet Cleaner

- F TTC/5 Tornado toilet cleaner 5L
- G TTC/1 Tornado toilet cleaner 1L
- H SD Sluice detergent 5L
- I CBL Channel blocks lemon 3kg

Odour Killers

- J OD/5 O-Destroy perfumed odour killer 5L
- K OD/1 O-Destroy perfumed odour killer 1L
- L AAON/T Atlantis air odour neutraliser - trigger 750ml

Oven Cleaner

- M OC/T Oscar oven cleaner 750ml
- N OC/5 Oscar oven cleaner 5L
- O 039.047 Caustic soda 500g

Wash Up Liquid

- P SSWL Super strength wash up liquid 20% 5L
- Q LWUL/1 Lemon wash up liquid 20% 1L
- R LWUL/5 Lemon wash up liquid 20% 5L
- S HAW15/5 High active wash up liquid 15% 5L
- T WUL10 Wash up liquid 10% 5L
- U FWUL Fairy liquid original wash up liquid 500ml
- V FWUL/5 Fairy liquid original wash up liquid 5L

Polish & Metal Cleaners

- W MSO/6 Mr Sheen original 300ml
- X FFP/5 Flawless furniture polish 5L
- Y FFP/T Flawless furniture polish - trigger 750ml
- Z BMP/1 Brasso metal polish 1L
- AA SSC/750 Stainless steel cleaner - trigger 750ml

Cloths and Cleaning Pads

- A FLC/* Flight all-purpose cloth - Pk50
Semi-disposable all-purpose cloth, 40gsm, 33 x 61cm.
* State colour: BL -Blue, R -Red, G -Green, Y -Yellow
- B FL002/* Flight standard cloth - Pk50
Semi-disposable all-purpose cloth, 40gsm, 30 x 35cm
* State colour: BL -Blue, R -Red, G -Green
- C RC/* Raider multi-purpose cloth - Pk25
Multi-purpose anti-bacterial cloth, 80gsm, 50 x 35cm.
* State colour: BL -Blue, R -Red, G -Green, Y -Yellow
- D MICC/*/10 Microfibre supercloth Pk25
Reusable cleaning cloth, 35 x 35cm
* State colour: BL -Blue, P -Pink, G -Green, Y -Yellow
- E JCR/* Non-woven centre-feed roll
* State colour: R -Red, Y -Yellow, G -Green Pk2, BL -Blue Pk2
- F DC/10 Dishcloth 30 x 40cm white - Pk10
- G SDC/10 Stockinette striped dishcloth Pk10
* State colour: BL -Blue, R -Red, G -Green, Y -Yellow
- H SRM Stockinette roll 2kg - medium
- I YD/10 Yellow duster hemmed 50 x 40cm - Pk10
- FD Feather duster 120cm
- J TT/10 Tea towel, catering quality - Pk10
- K SFP Soap filled pads
- L RSS Rochley spiral scourers Pk6
- M SUSS40 Stainless steel scourers 40g - Pk20
- N GSP/10 Green scouring pads 15 x 22cm - Pk10
- O OG Pair of oven gloves
- 267.010 Waiter cloth
- 001.036 Oven cloth
- P 827/10 Large sponge scourers - Pk10

Mopping Products

- Q PXS12* No 12 P.Y. socket mop
* State colour: B -Blue, R -Red, G -Green, Y -Yellow
- R HYS20* Optima hygiene socket mop 200gms
* State colour: B -Blue, R -Red, G -Green, Y -Yellow
- S EAH120* Aluminium mop handle 120cm
* State colour: B -Blue, R -Red, G -Green, Y -Yellow
- T 5050* Mop bucket 12L with wringer
- OWT3 Mop wall tidy - for 3 mops



Sundry Items



- A TSB700 Trigger spray bottle 700ml
* Available in: Blue/Red/Yellow/Green
- B TBS Toilet brush set - white
- C DBS/* Dustpan and brush set
* State colour: B -Blue, R -Red, G -Green, Y -Yellow
- LHDPB Long handled dustpan and brush set
- 011270C Sweeping brush with handle
300mm wide. (Coco)
- D WLME 12" hygiene broom - soft bristle
- E WLHT 12" hygiene broom - stiff bristle
- F WFS Wet floor sign

Household Gloves

- Sizes: S - small; M - medium; L - large
- RG/B/size Household rubber gloves - blue - 1 pair
 - RG/P/size Household rubber gloves - pink - 1 pair
 - RG/G/size Household rubber gloves - blue - 1 pair
 - RG/Y/size Household rubber gloves - yellow - 1 pair
 - STGL Stockinette glove liners - 1 pair

Vacuum Cleaners

- H 9321GY Sebo BS36 upright vacuum cleaner
- I 9331GY Sebo BS46 upright vacuum cleaner
Twin motor upright vacuum cleaners giving excellent performance, outstanding reliability and easy maintenance. Their ability to clean when flat and their low profile cleaning heads enable them to reach under furniture and clean right up to skirting boards. Cleaning width: BS36 - 14in; BS46 - 18in.
- J HVC Henry vacuum cleaner
Powerful 1.2kW commercial dry vacuum cleaner with high efficiency dust filter, stainless steel tubes and 10m cable. Suitable for use with or without bags. Accessory kit for carpets, floors, curtains and upholstery.
- K P265 Combi Vac Pro wet and dry vacuum cleaner
Versatile, multi-purpose 1kW wet and dry vacuum and blower. Tough construction, complete with 5m cable and accessories.

Vacuum Cleaner Bags

- 1055 For Sebo BS36/BS46 - pk10
- 5093ER For Sebo X370 - pk10
- 7029 For Sebo Dart 2 - pk10
- NVM-1C 2-Layer dust bags for Henry/James - pk10

Carpet Cleaners

- A GCC George vacuum and carpet cleaner
A 1.2kW professional quality, 'all-in-one' machine for dry vacuuming, wet vacuuming, scrubbing and drying hard floors, deep cleaning carpets, cleaning upholstery or even unblocking the sink!
- B CT470-2 Numatic cylinder carpet cleaner
- C CT570-2 Numatic heavy duty cylinder carpet cleaner
Professional 1.2kW carpet cleaning system with a power head incorporating the high performance Twinflo bypass motor and Powerflo pump system for efficient discharge and liquid collection. The heavy duty CT570-2 has Structofoam construction, designed to take the knocks suffered in full commercial use.

Catering Consumables

- D SPD450 Catering foil 450mm x 75m roll
- E SPD423 Catering cling film 450mm x 300m roll
- F SPD425 Baking parchment 450mm x 50m
- G TC Tray covers white 30 x 40cm - Pk250
- H OTC Oval tray covers white 28.5cm Pk250
- I N2W Napkin 2 ply white 33 x 33cm - Pk2000
- N1W Napkin 1 ply white 33 x 33cm - Pk5000

Polyester Table Linen

- 100% spun polyester table linen
- J Woven Rose design - preface order code with WR
- K Ivy Leaf design - preface order code with IL

Napkin	
2222*	55 x 55cm 22 x 22in
Tablecloths	
3535*	89 x 89cm 35 x 35in
4545*	115 x 115cm 45 x 45in
5454*	137 x 137cm 54 x 54in
5470*	137 x 178cm 54 x 70in
5490*	137 x 230cm 54 x 90in
7070*	178 x 178cm 70 x 70in
7090*	178 x 229cm 70 x 90in
70108*	178 x 275cm 70 x 108in
70144*	178 x 367cm 70 x 144in
9090*	229 x 229cm 90 x 90in
52d*	132cm dia 52in dia
68d*	173cm dia 68in dia
88d*	223cm dia 88in dia

*Colours available: White - Ivory - Peach - Gold - Dusky Pink - Seafoam - Wedgewood Blue - Chelsea Yellow - Sandalwood - Red - Terracotta - Burgundy - Forest Green - Royal Blue - Navy - Tango - Purple - Black



Tableware

- Cutlery - stainless steel
 Plain pattern 18/0 stainless steel cutlery range
 SSTF Table fork - pk12
 SSTK Table knife - pk12
 SSDS Dessert spoon - pk12
 SSSS Soup spoon - pk12
 SSTS Tea spoon - pk12

Crockery - Athena hotel ware
 Great value white porcelain range; tough, functional and practical. Chip-resistant rolled edges; fully vitrified durable glaze; oven, microwave and dishwasher safe.

- P5-CC200 Stacking cup 7oz - pk24
 P5-CC201 Cappuccino cup 8oz - pk24
 P5-CC202 Saucer for above - pk24
 P5-CC203 Mug 10oz - pk12
 P5-CC204 Beverage pot 2 cup - pk4
 P5-CC205 Sachet holder - pk6
 P5-CC206 6.5in wide rimmed plate - pk12
 P5-CC207 8in wide rimmed plate - pk12
 P5-CC208 9in wide rimmed plate - pk12
 P5-CC209 10in wide rimmed plate - pk12
 P5-CC210 11in wide rimmed plate - pk6
 P5-CC213 Oatmeal bowl - pk12
 P5-CC214 Rimmed soup bowl - pk6
 P5-CC215 Salt shaker 50mm - pk12
 P5-CC216 Pepper shaker 50mm - pk12

We supply an extensive range of tableware including leading brands - please contact our sales office.



Paper Products & Dispensers

WC Paper

Hand Towels

Dispensers



“ Our range combines competitive pricing with superb quality. This range is designed to meet every care homes requirements. ”

WC Paper

- A** WC320/36 WC roll 2 ply 320 sheet - Pk36 rolls
Great value toilet paper, soft and strong.
- B** CSTT/40 Cushion soft toilet tissue - 40 rolls
- C** BP/36 Bulk pack 2 ply 250 sheet - Pk36
Good quality toilet paper, with bulk pack value.
- D** JR2/6 Jumbo roll 2 ply 2" core - Pk6
300m dispenser roll with 2" core.
- JR3/6** Jumbo roll 2 ply 3" core - Pk6
300m dispenser roll with 3" core.
- E** MJR2/12 Mini jumbo roll 2 ply 2" core - Pk12
150m dispenser roll with 2" core.
- MJR3/12** Mini jumbo roll 2 ply 3" core - Pk12
150m dispenser roll with 3" core.
- AO24AL** Lotus compact toilet tissue 900 sheet - 36 rolls
- F** AO24A Compact toilet tissue 900 sheet - 36 rolls



Paper Rolls

- G** CFW/6 Centrefeed 2 ply white 150m roll - Pk6
- H** CFB/6 Centrefeed 2 ply blue 150m roll - Pk6
- I** MCF/12 Mini centrefeed 2 ply 60m roll - Pk12
- J** CR10/18 Hygiene/couch roll 10" x 100 sheets white -Pk18
- K** CR10/18B Hygiene/couch roll 10" x 100 sheets blue - Pk18
10" wide roll-out paper for the hygienic covering of couches and examination tables.
- L** CR20/9 Hygiene/couch roll 20"x100 sheets white - Pk9
- CR20/9B** Hygiene/couch roll 20"x100 sheets blue - Pk9
20" wide roll-out paper for the hygienic covering of couches and examination tables.



Hand Towels

- M** FHT3600 Single interfold hand towel - Pk3600
- N** CFHT C-fold hand towel - Pk2688
- CFHT - B C-fold hand towel - blue Pk2944
- CFHT - W C-fold hand towel - white Pk2944
- O** ZFHT Z-fold hand towel - Pk3000
- P** FT100 Facial tissue 2 ply - Pk100
- Q** KT/24 Titan kitchen towel - twin pack



SEE NEXT PAGE FOR DISPENSERS

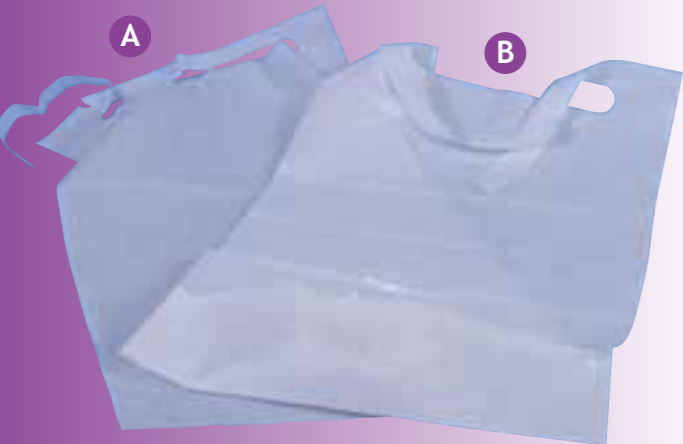

Disposable Bibs

- A RDB001 Disposable bib with pouch - Pk125**
Hygienic bibs for the prevention of soiled clothing at mealtimes. Size 37 x 66cm.
- B RDB157 Heavy duty disposable bib with pouch - Pk125**
Hygienic, heavy duty bibs for the prevention of soiled clothing at mealtimes. Size 37 x 70cm.

Hand Towel Dispenser

- C HTD Small hand towel dispenser**
For C-fold and Z-fold paper towels. Manufactured from impact resistant ABS plastic, with secure key-lock and level indicator window. Also available in large.

Toilet Paper Jumbo Roll Dispensers

- D JRD Jumbo roll dispenser**
- E MJRD Mini jumbo roll dispenser**
For perforated or non-perforated paper. Manufactured from impact resistant ABS plastic, with secure key-lock.

Centrefeed Roll Dispensers

- F CRD Centrefeed roll dispenser**
- MCRD Mini centrefeed roll dispenser**
For perforated or non-perforated paper. Side opening with key-lock, and manufactured from impact resistant ABS plastic.

Polythene Apron Roll Dispenser

- G 2160 Polythene apron roll dispenser**
For disposable aprons on a roll - see page 3

Pump Dispenser

- H SPD824 5L pump dispenser**
To fit standard 5L soap containers.

Glove Dispensers

- I 2140 1 box glove dispenser**
- 2135 3 box glove dispenser**
Wall mounted dispensers for 1 or 3 boxes of disposable gloves. For disposable gloves see page 3.



Toiletries

Hair and Personal Care

Bath Care and Soap



“Featuring essential everyday consumables for your Care Home”

Personal Care

- A FNC Finger nail clippers
- B TNC Toe nail clippers
- C PNB Plastic nail brush
- D CB Cotton buds Pk100

Hair Care

- E EHB Economy hair brush
- F DCL Dress comb - large
- G PC Pocket comb
- H NC Nit comb
- I SH Shampoo - normal hair 500ml
- J COND Conditioner - frequent 500ml
- K HS Hairspray - natural hold 200ml
- L SM Styling mousse 400ml
- M RSC905 Oasis rinse free shampoo cap

Bath Care & Soap

- N FB Foam bath 1L
- O BB Infacare baby bath 500ml
- P SG Shower gel 250ml
- Q SS Simple bath soap - Pk2
- R BMS/72 Buttermilk soap - Pk72
- BS100 Bath soap 100g
- S BW/6 IL softening bodywash
- T IL125 Bath soap 125g
- BW Berry bodywash - raspberry 500ml
- U TALC Family talc - bouquet 350g
- V RSC901 Oasis bed bath - Pk10



Dental Care

- A SUT Superdent tablets - Pk30
- B STT Steradent tablets - Pk30
- C TP/12 Toothpaste 50ml
- D TB/12 Adult toothbrush
- E MW500 Mouthwash 500ml

Deodorant

- F FD Female anti-perspirant deodorant 150ml
- G FRO/12 Female roll-on caring deodorant 50ml
- H MD Male anti-perspirant deodorant 200ml

Shaving Products

- I SF Shave foam 400ml
- J BDR Bic disposable razors - Pk5
- K GB2/5 Gillette Blue II disposable razors - Pk5

Stockings & Tights

- L ST40M Stockings 40 denier - mink 1 pair
- M ST40H Stockings 40 denier - honey 1 pair
- T20B Tights 20 denier - black - Pk3 pairs
- N T20N Tights 20 denier - natural - Pk3 pairs
- STGL Stockinette glove liners - one size - 1 pair



Pressure Care Products

Alternating Pressure Care Systems

Mattress

Cushions

Overlays and Underlays

Static Pressure Care Systems

Mattresses

Cushions

Elbow and Heel Pads



“ With our products we aim to provide maximum patient comfort whilst achieving optimum pressure relief. ”

Alternating Pressure Care Systems

Where 'risk' categories are given, these are to the Waterlow scale and are for guidance only.

- A HB100 BUBBLE alternating overlay system**
- HB100C BUBBLE alternating overlay system with cushion**

The BUBBLE system is an alternating overlay mattress system for the prevention and treatment of pressure ulcers in low risk patients, and is ideal for both community and homecare environments. Weight limit 12 stone/76kg.

- Manual pressure control functions
- Visual low pressure indicator
- Low running costs
- Quiet operation

- B 19002 ALTAIRE alternating overlay system**
- 19007 ALTAIRE alternating overlay system - 24 hour**

The ALTAIRE overlay system is a portable air alternating overlay system designed to provide therapy for patients who suffer from pressure ulcers and require Med/High risk care. This system is equipped with a quiet and easy to operate pump unit to provide optimal pressure relief and excellent sleeping quality. A perfect choice. The 24hr system assures patients have effective pressure relief every moment they are sitting or lying. System includes 1 x Pump unit, 1 x mattress & 1 x cushion.

Risk category: Med/High
Max user weight: 150kg.
Water low score: 13 - 15

- C POLAR POLARIS alternating overlay system**

POLARIS is a replacement mattress and pump system for the prevention and treatment of pressure ulcers in high risk patients. Features an electronic pressure sensor for correct weight/inflation ratio with adjustable time cycle. 8" inflatable cells with 2" foam base. Zipped quilted waterproof yet breathable mattress cover.

Risk category: High
Max user weight: 180kg
Water low score: 20 - 22

- D 1504251 Andway premier active mattress system**

A unique design alternating air insert beneath a castellated foam topper. This mattress is a high/very high risk surface. This system includes a pump which has auto sensory software, and a multi stretch cover.

Risk category: high/v high
Max user weight: 247.6Kg (39 Stone).

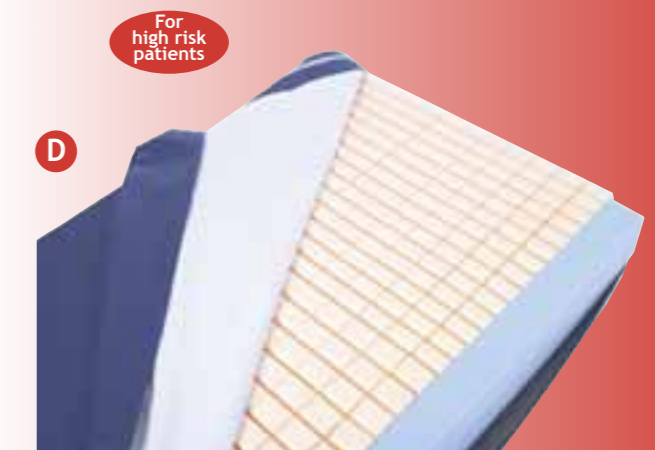



A 19000 MEDEXCARE alternating replacement system
 The MEDEXCARE is a high risk replacement system with alternating pressure. It is the ideal therapy system for different positions and treatment purposes to suit patients who demand pressure ulcer prevention or treatment. Features a pillow and CPR function.
Risk category: High
Max user weight: 180kg
Water low score: 20 - 22.



B 19006 DELTA III alternating replacement system
 This air alternating pressure system is indicated for the prevention and treatment of skin breakdown and pressure ulcers in patients at high to very high risk. The 2" foam base provides an extra layer of static protection and prevents the patient from bottoming out in the event of an interruption to the power.
Risk category: very high
Max user weight: 200kg.
Water low score: 25 - 27



C 19010 DUAL alternating replacement system
 An outstanding air mattress replacement system with a combination of alternating and static functions for very high risk users. An ideal therapy system, with upright and firm modes for different positions and treatment purposes with digitally controlled alternating and a CPR function.
Risk category: very high
Max user weight: 200kg.
Water low score: 25 - 27



D 19008 SUMMIT alternating replacement system
 The SUMMIT system is a fully automatic replacement mattress system with battery backup suitable for very high risk clients and bariatric patients. Features a self weigh and body mass measurement, CPR function.
Risk category: very high
Max user weight: 300kg.
Water low score: 28 - 30.



E 19009 THERAFLO low air loss replacement system
 The THERAFLOW is a true low air loss therapy mattress replacement system designed to facilitate blood circulation and provide maximum body tissue redistribution for treating and preventing pressure ulcers up to grade IV - Bariatric and very high risk patients. Features a CPR facility and panel lock function.
Risk category: very high
Max user weight: 450kg
Water low score: 28 - 30.



F HS500 Partnership double alternating mattress system
HS500C Partnership double alternating mattress system with cushion
 The Partnership is a double bed sized mattress with one side of foam and the other side alternating pressure relieving air cells on a foam base with foam perimeter. The alternating side will provide for patients at medium/high risk of developing pressure ulcers or the treatment of existing ulcers. The system is based on the clinically tested Supreme overlay mattress system. The mattress can be turned for either side of bed to be used for pressure relief to suit the normal sleeping arrangements. Weight limit 24 stone/152kg.

- Maintains quality of life by enabling couples to stay together
- Waterproof two-way stretch vapour-permeable cover reduces shear and friction
- Extended warranties available
- Easy to install and operate
- Lightweight and portable. Folds to single mattress size
- Cost effective - low running costs
- Easy to clean and launder
- Clinically evaluated

Alternating Pressure Care Cushion Systems

The full one-piece alternating cushion and lumbar system has been developed to provide maximum patient comfort whilst achieving the optimum pressure relief whilst seated. It is especially beneficial to patients who can no longer sleep in a hospital type bed, and provides daytime relief and pressure reduction during periods out of bed.

This inexpensive system provides relief and comfort for those at risk of developing a pressure ulcer or sore as well as assisting in the healing of existing problem areas.

The system is operated by the Supreme pump and therefore can be used in conjunction with this high risk system to give 24 hour care and protection. Also available without lumbar support, to provide pressure relief/reduction to the sacrum area only.

- A HH23 Cushion and lumbar - 3 pipe**
 - HH24 Seat and lumbar cushion only**
 - HH43 Seat, lumbar and leg support system - 3 pipe**
 - HH44 Seat, lumbar and leg cushion only**
- 19003 ALTAIRE cushion**
 - 19004 ALTAIRE 2 port pump**



Static Pressure Care Mattresses and Overlays

- B HFU110 Underlay mattress**
 An economy 50mm thick mattress with two-way stretch vapour permeable cover, designed to fit directly on the bed base and used underneath an active mattress system with the intention of helping to reduce overall height.

HFCM118 Community foam mattress
 The Community mattress is a block foam mattress, designed especially for the community market. Weight limit Size 2000 x 900 x 127mm.
Max user weight: 114kg

The mattress is supplied with a fully fitted two-way stretch vapour-permeable waterproof cover.

- C HFM096 Community profiling foam mattress**
 A modulated version of the standard Community mattress, to accommodate fully profiling beds.
 Size 2000 x 900 x 127mm.
Max user weight: 114kg





Overlay Mattresses

- A HF0117 Fibre filled overlay**
The fibre filled overlay mattress is an inexpensive one-piece mattress designed to ensure patient comfort and support.
Size 1880 x 865mm with generous filling.
Risk category: low
Max user weight: 101kg
- B HF0122 Modular foam overlay**
The modular foam overlay is an inexpensive one-piece mattress overlay. It is designed to ensure comfort, support and pressure reduction for patients at a low risk of developing a pressure ulcer. Supplied with a fully fitted two-way stretch vapour-permeable cover. Size 1880 x 965 x 95mm.
Risk category: low
Max user weight: 108kg
- C HGC103 Apollo moulded mattress**
The Apollo moulded monoblock mattress is a quality replacement mattress designed for long life and low maintenance, for low risk patients. It is moulded in resilient Zyprex foam and easily allows for the movement of electrically operated beds.
Risk category: low
- D HF0078 Visco Combi overlay mattress**
HF0078D Visco Combi double overlay mattress
This popular mattress is intended for use on top of an existing mattress and consists of 30mm of visco on a supportive foam base, with a two-way stretch vapour permeable cover.
Risk category: medium
- HGC210 Alova overlay**
Alova memory foam overlay with waterproof easy clean cover.
Risk category: high

Replacement Mattresses

- E 15010 Andway TAURIS Mattress**
A foam mattress with a stitched, 2 way stretch vapour permeable cover. Water proof.
Risk Category: med
Max user weight: 185kg
 - F HFRM120 Modular foam replacement mattress**
The modular foam replacement mattress is suitable for all types of beds. The modular design allows the mattress to profile to any type of mattress base, thus reducing the effects of shear and friction for patients at medium risk.
Risk category: medium
Max user weight: 114kg
- Turning cycle is printed on cover and should be adhered to in order to prevent 'bottoming out' over extended periods.
Size 2000 x 900 x 160mm.
- HFRM105 Modular foam replacement 30 stone mattress**
A bariatric version of the above mattress.
Risk category: medium
Max user weight: 190kg

- A HFMM109 Visco memory foam / foam replacement mattress**
HFDM91 Visco memory foam / foam replacement double mattress
These mattresses provide medium risk enhanced comfort when compared with standard foam mattresses but are not as expensive as the full memory mattresses.
Risk category: medium
Max user weight: 114kg
- The top and bottom layers are each 30mm thick visco foam bonded to a memory foam core. A two-way stretch vapour-permeable cover is used on these mattresses providing a recommended turning cycle allowing recovery time for the foam. The 'wrap round' effect of the visco foam provides sleep enhancing features as well as pressure reduction.
Size 2000 x 900mm or double 2000 x 1370mm.
- B HFVM120 Diamond replacement mattress**
The Diamond is a superb comfort profiling mattress with a pressure-distributing visco-elastic insert in a high quality multi-stretch vapour permeable cover. It is suitable for medium to high risk. Silvosan® antibacterial coated.
Risk category: med/high
Max user weight: 28 stone
 - C HFR288 Prime Comfort replacement mattress**
The Prime Comfort replacement mattress is suitable for any bed type. It consists of a two piece construction upper layer modular foam pad, with high density base foam. The cover is a two-way stretch PD with welded seams. Suitable for those at high risk of developing pressure ulcers.
Risk category: high
 - D HFR127 Reflect replacement mattress**
HFR127D Reflect replacement double mattress
The Reflect is a memory foam / foam mattress which is fully profiled on both faces and is suitable for all types of bed. It can be used either side uppermost although normally used with the visco side to the body to provide the close support to the body contours that achieves this luxury-feel effect. Turning is not required, but 'spinning' to change the body imprint is advisable. The profiled surfaces increase under-body ventilation and enhance the airflow around the mattress.
Size 2000 x 900 x 170mm or double 2000 x 1370 x 170mm.
Risk category: high
 - E HGC211 Alova replacement mattress**
The Alova is a multi softness monoblock viscoelastic zonal mattress with contoured heel support. It is for high risk patients.
Risk category: high
Max user weight: 30 stone
 - F 15000 Andway LEONIS II Mattress**
A high risk replacement mattress with vapour permeable cover, sewn seams and zip. Suitable for use with profile beds and meets BS7177 regulations. This mattress is 4 way turn, profiled both sides.
Risk Category: high
Max user weight: 213kg / 34st



Static Pressure Care Cushions

- A HFC113 Fibre filled cushion**
The fibre filled seat cushion is available in one size and is classified as a comfort cushion. The zipped cover is two-way stretch and vapour-permeable. Size 430 x 430 x 100mm.
- B HFC121 Modular foam cushion 17" x 17"**
HFC116 Modular foam cushion 20" x 20"
The modular foam cushion is designed to provide pressure reduction, combined with stability and a high level of comfort. It comes complete with a two-way stretch vapour-permeable waterproof cover and is for low risk usage. Sizes 430 x 430 x 100mm and 500 x 500 x 100mm.
- C HFC129 Visco top cushion**
The Visco top is covered with a 50mm visco layer on a high density foam base. It is classed as medium risk. Size 430 x 430 x 76mm.
- D HFC128 Visco cushion**
The Visco cushion is a two-way turn memory cushion of sandwich construction, with visco to both surfaces bonded to a high resilience core. It is classed as medium risk. Size 430 x 430 x 95mm.
- E HFC130 Reflect cushion**
The Reflect cushion is a high risk castellated visco cushion on a high density foam base and is covered with a two-way stretch vapour permeable cover. It is classed as medium risk. Size 430 x 430 x 100mm.
- F HGC208 Prevogel wheelchair cushion**
The Prevogel is made of a viscoelastic gel layer curved in the ischial area and features a high resilience foam support. The overall assembly is protected on five of its sides by a neoprene envelope cover with a waterproof non-slip layer on the base. This cushion is suitable for users with high level risk for users without stability problems. Size 400 x 400 x 60mm.
- G HGC209 Alova memory foam cushion**
Made from tri-dimensional polymer based 'memory' material, this cushion is specially developed with an inclination forward-backward to distribute weight away from the ischials and towards the trochanters and thigh area for added support. The rounded cell form provides optimal pelvic positioning and improved stability. The standard stock softness is medium, but soft and firm are also available. Classed as for high risk, and supplied complete with cover. Size 430 x 430 x 95mm.
- H HGC201 Gel cushion**
The Gel cushion has a viscoelastic polyurethane gel with the same elastic characteristics as the skin and reproduces the consistency of the fatty tissue acting as a skin protector and 'shock absorber' to avoid the development and progression of pressure sores. Classed as for high risk use.

The gel moulds to body shape and movement, eases friction and shear and provides force distribution at pressure points. It does not leak, run or slide and is impermeable to liquids but permeable to x-rays. The cushion is sterilisable, autoclavable, non-allergenic and hygienic. 400 x 400 x 50mm.

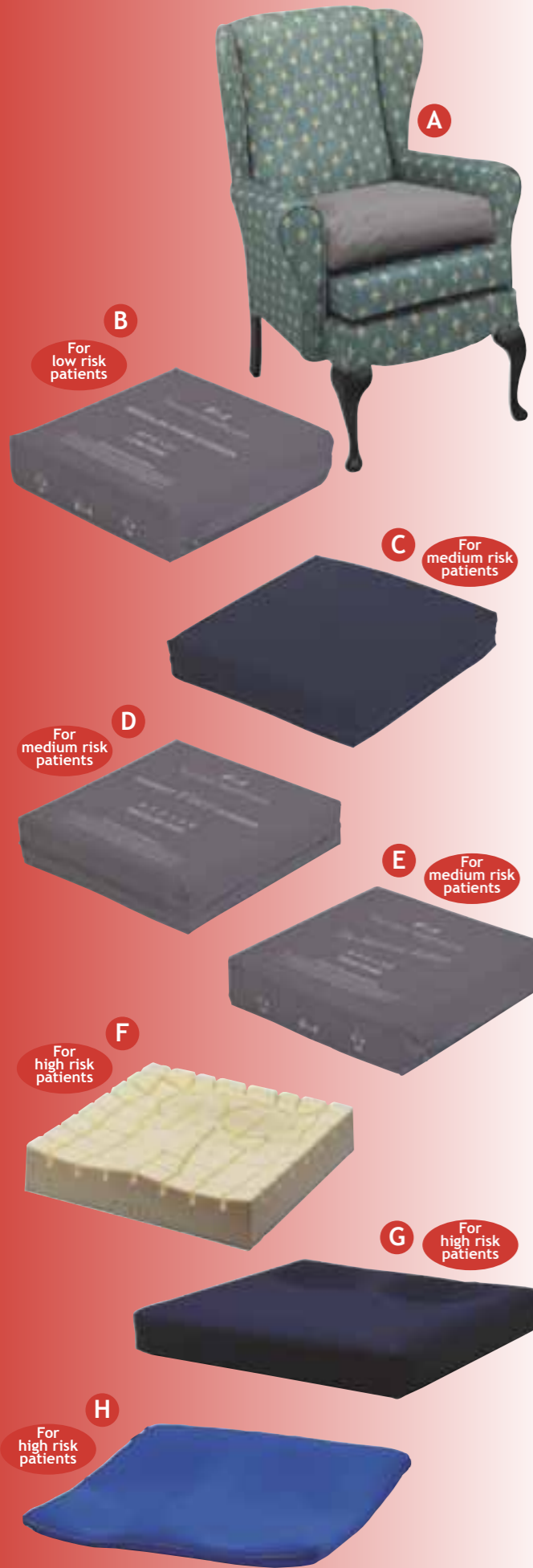

- A HGC202 Gel and foam cushion**
The gel and foam cushion comprises a 10mm gel layer on a 35mm polyurethane foam base. Classed as high risk. Size 400 x 400 x 50mm.
- B HGC204 Kineris pressure cushion**
HGC205 Kineris pressure cushion dual valve
Adjustable inflatable cushion with individually deformable cells. The air circulates very slowly between cells, to ensure pressure distribution while preserving stability. The adjustment of the internal pressures according to the morphology of the body helps obtain a large supporting surface due to the immersion of the body into the cushion.

The individually deformable pads reduce the surface stresses and therefore reduce pressures in the iscular tuberosity areas, and the prominent and movable cells follow the movement of the body, thus minimising the effect of shearing of tissues. Suitable for high levels of pressure ulcer risk. Sizes: HGC204, 480 x 480 x 100mm; HGC205, 440 x 440 x 100mm.

Elbow and Heel Pads

- C HFP125 Andway elbow pads - 1 pair**
HFP126 Andway heel pads - 1 pair
Fibre filled elbow or heel pads with vapour-permeable cover and Velcro fitting straps.
- D HGC213 Enveloping heel pad**
HGC215 Stabilising heel pad
Heel pads filled with a polyurethane gel which moulds to body shape and movement. The Stabilising heel pad has been designed to prevent nosocomial infections.
- E HGC248 Abduction cushion for knees**
680 x 515mm.
- F HGC249 Universal cushion size 1**
HGC250 Universal cushion size 2
Size 1: 410 x 310mm. Size 2: 640 x 440mm.
- G HGC251 Cylinder cushion**
210dia x 600mm
- H HGC252 Positioning cushion for heel**
412 x 228
- I HGC253 Positioning cushion for hand**
412 x 228
- J HGC254 Positioning cushion for hip**
342 x 300
- K HGC255 Decubitus positioning cushion**
1830 x 666mm
- L HGC257 Half moon positioning cushion**
- M HGC217 Decubitus wedge**
Designed to position the patient at risk from pressure at 30° lateral, either on the left or right hand side, thus reducing pressure on the sacral area.



Moving & Handling Equipment

- Patient Lifters
- Bath Hoists
- Slings
- Sliding Products
- Handling Belts
- Turning Products
- Evacuation Items



“ We ensure the patients and carers needs are met in terms of function, reliability, manoeuvrability and safety with our Moving and Handling Equipment. ”

Mobile Patient Lifters

Mobile hoists ensure comfort and safety and address the patients' needs in terms of function, reliability, manoeuvrability and ease.

BIRD2-150M BIRDIE 150 hoist (manual leg opening)
 Hoist picks up from the floor using the Linak Jumbo control system. Folding hoist this requires no tools and can be dismantled into 2 parts - this hoist is ideal for use in passenger lifts.
Max user weight: 150Kg (23.62 stone)
Max overall length: 63.3 inches

A BIRD2-170M BIRDIE 170 Hoist (manual leg opening)
BIRD2-170E BIRDIE 170 Hoist (electric leg opening)
 Folding hoist that requires no tools and can be dismantled into 2 parts. Ideal hoist for use in passenger lifts, using the Linak Jumbo control system.
Max user weight: 170Kg (26.77 stone)
Max overall length: 18.3 - 68.3 inches

BIRDIE hoists are folding hoists and can be dismantled without tools into 2 parts. These are ideal for use in passenger lifts and other compact areas. The high boom maximizes space for the client even when the hoist is in the highest position. This makes placing the client into a bed/wheelchair much easier for the carer. Takes up minimal space when stored and is easy to push and transport. For total security the hoists come with a snap-lock system, thus minimizing the risk of accident.

Transport and patient comfort go hand-in-hand with these hoists.

B A BIRDIE compact hoist version is available.

C 14001 CASALIFT Mobile Hoist - 140kg
14002 CASALIFT Mobile Hoist - 180kg
 The CASALIFT mobile hoist is a new lightweight, compact, manoeuvrable hoist that is very easy to service and maintain. With electric leg opening and two 360° swivelling braked rear castors. The control box also includes emergency stop and charge status. Features a low battery alarm, exchangeable cable and emergency lowering.
Max user weight 14001: 140kg
Max user weight 18004: 180kg

GHH Graduate hydraulic hoist
A GEH Graduate electric hoist
 The Graduate has been designed for residential and nursing homes with low usage and limited space in mind. It is compact and easy to use, with 100mm castors for manoeuvrability, and will lift from the floor, chair or bed.
Max user weight : 150kg.

SHH Scholar hydraulic hoist
B SEH Scholar electric hoist
 Ideal for low to medium usage in residential and nursing homes, the Scholar has all the advantages of the Graduate hoist, plus a higher lifting range.
Max user weight: 175kg

C MHH Master hydraulic hoist
MEH Master electric hoist
 The Master hoist is the perfect product for the multi-use environment such as nursing homes and hospitals where there is heavy usage. With its high lifting capacity and heavy duty load limit of 200kg it will work well in most locations.
Max user weight: 200kg

D ASC225 ASCENT 225 Mobile Hoist - HIGH CAPACITY
 This hoist has been designed and developed in conjunction with healthcare professionals. It features a Linak Jumbo Care control system, LCD display and has a robust hard wearing construction. Also features a removable non-slip footplate for ease of cleaning and height adjustable knee pad. The leg spread is electrically operated and has a high speed and soft stop function to reduce transfer time.
Max user weight: 225kg

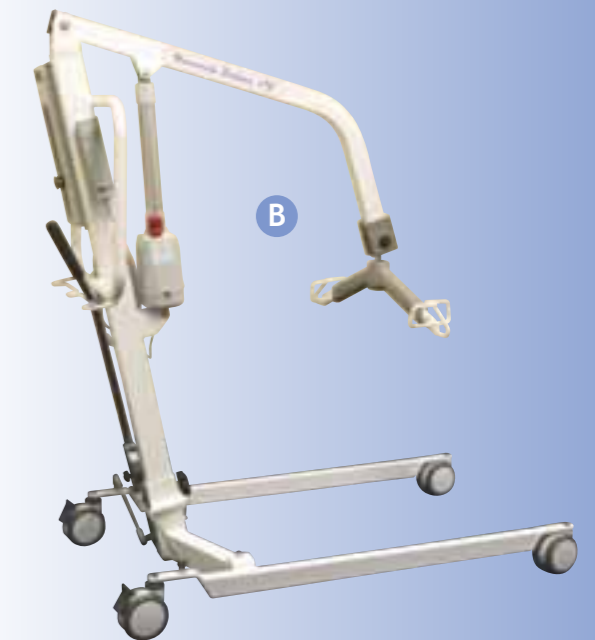
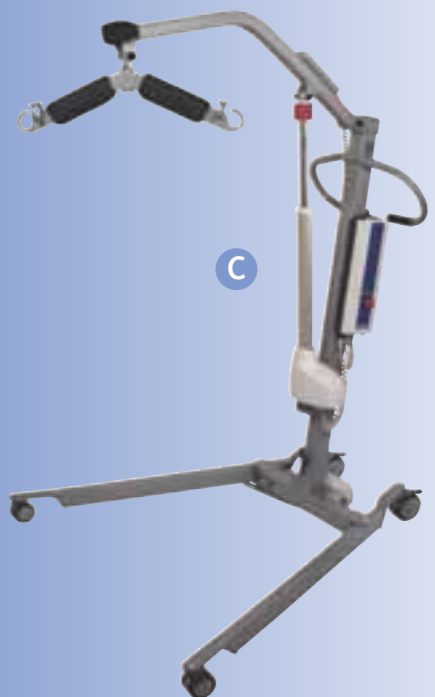
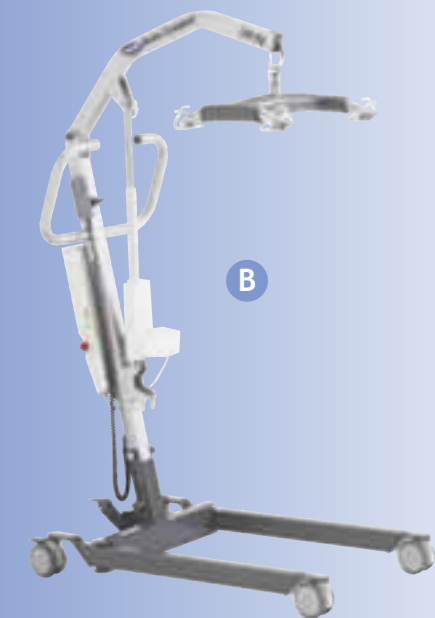

Mobile Dual Purpose and Standing Lifters

- A 045 Select Multi-lift**
- Two in one hoist gives great value for money
 - Spreader bar fixings provide safety for sling attachments
 - Height and width adjustable shin pads
 - 160kg (25 stone) lifting capacity
 - A1 shows normal attachment; A2 shows standing attachment
- B 124 Select Kelly stand**
- Unique handle bars encourage patients to push down in order to stand
 - Height and width adjustable shin pad
 - 160kg weight limit
 - Powered raising, lowering and leg opening facility
- C REL350 Reliant 350 Stand-assist**
- The Reliant 350 is compact and manoeuvrable to provide easy, safe and comfortable assisted transfers for patients in care, or those with rehabilitation needs. Its design allows patients to be transferred or assisted from either a bed or a chair. 158kg lifting capacity.
- D 19600 Salsa stand up lifter**
- Designed as an active standing aid, the Salsa allows a single carer to raise a patient into a comfortable and secure standing position. It is ideal for transferring from bed to chair or chair to commode. Allied to the Salsa is a padded sling which allows superior access to remove clothing for toileting purposes. With a small footprint and light weight it is highly manoeuvrable and has a safe working load of 200kg.

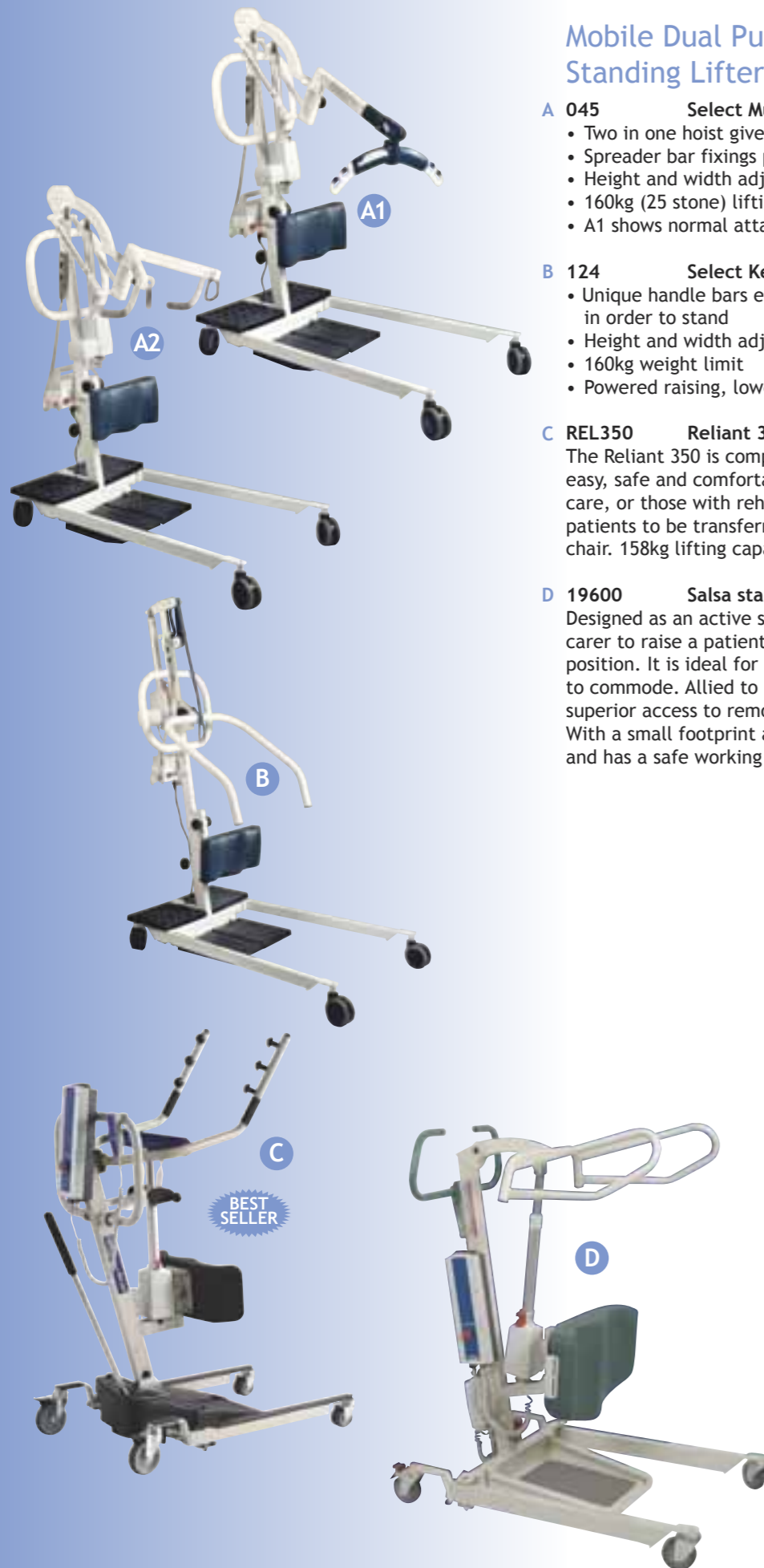

Bath Hoists

- A Andway university bath hoist**
 Andway university bath hoist - commode
 Andway university bath hoist - transporter
 Andway university bath hoist - MD version

These are available in manual and electric and with the end and side arm options, please specify when ordering. The University range of bath hoists is manufactured to a high standard and has a 130kg safe working load. The hoist moves through 360° and has a locking position every 90° to ensure a safe and secure transfer. It is finished in a white plastic coating for durability and warmth, with a moulded seat.

Please contact our sales office on: 01423 331000 for more information on our extensive range of bath hoists.

Slings

- C 20000 Fastfit polyester padded sling - small**
 20001 Fastfit polyester padded sling - medium
 20002 Fastfit polyester padded sling - large
 20003 Fastfit polyester padded sling - XL
- 2001M Fastfit net padded bathing sling - small**
 2002M Fastfit net padded bathing sling - medium
 2003M Fastfit net padded bathing sling - large
 2004M Fastfit net padded bathing sling - XL
- 2005H Fastfit poly padded with head support - small**
 2006H Fastfit poly padded with head support - medium
 2007H Fastfit poly padded with head support - large
 2008H Fastfit poly padded with head support - XL
- The Fastfit sling is versatile and designed to suit most patients when using the standard yoke attachment in the lifter. Fastfit slings are padded and are available in either polyester fabric or net, suitable for bathing.
- D 20010 Fastfit Deluxe polyester padded - small**
 20011 Fastfit Deluxe polyester padded - medium
 20012 Fastfit Deluxe polyester padded - large
- 20080 Fastfit Deluxe net padded - small**
 20081 Fastfit Deluxe net padded - medium
 20082 Fastfit Deluxe net padded - large
- The Fastfit Fit Deluxe sling provides greater support and comfort to a larger selection of patients.
- E 20050 Fastfit polyester toileting sling - small**
 20051 Fastfit polyester toileting sling - medium
 20052 Fastfit polyester toileting sling - large
 20053 Fastfit polyester toileting sling - XL
- The Fastfit Toilet Sling is specially designed to facilitate toilet transfers. XL and certain special requirements are available on request.

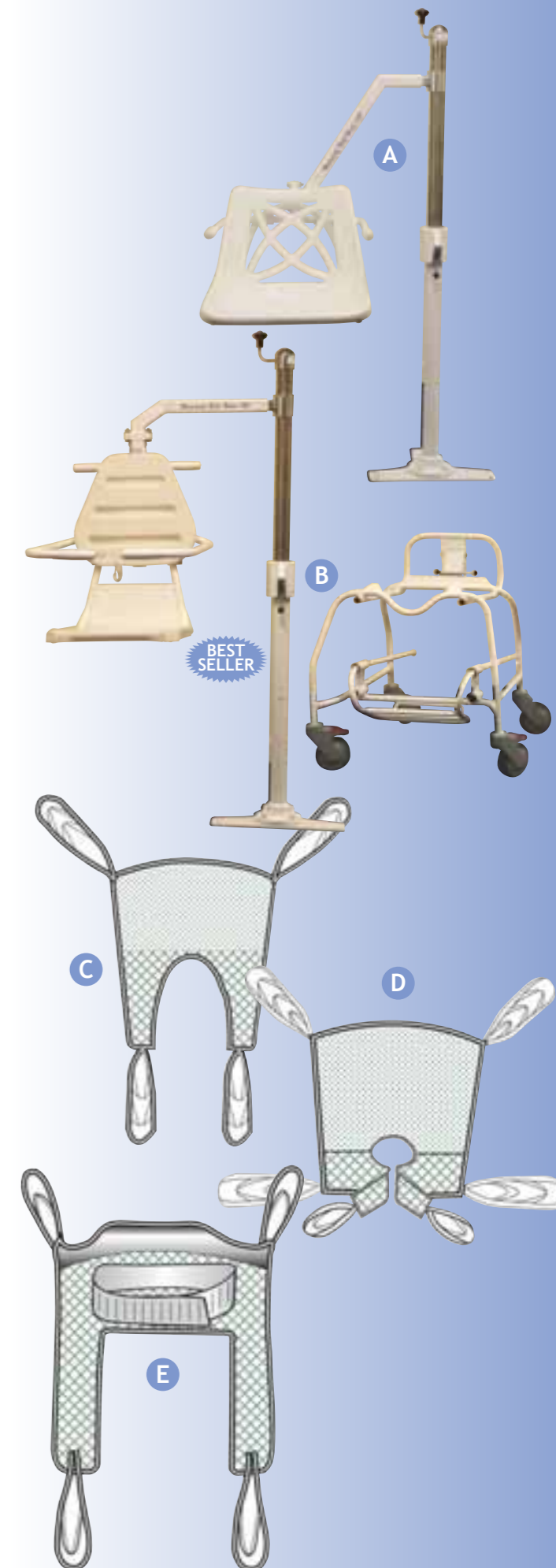

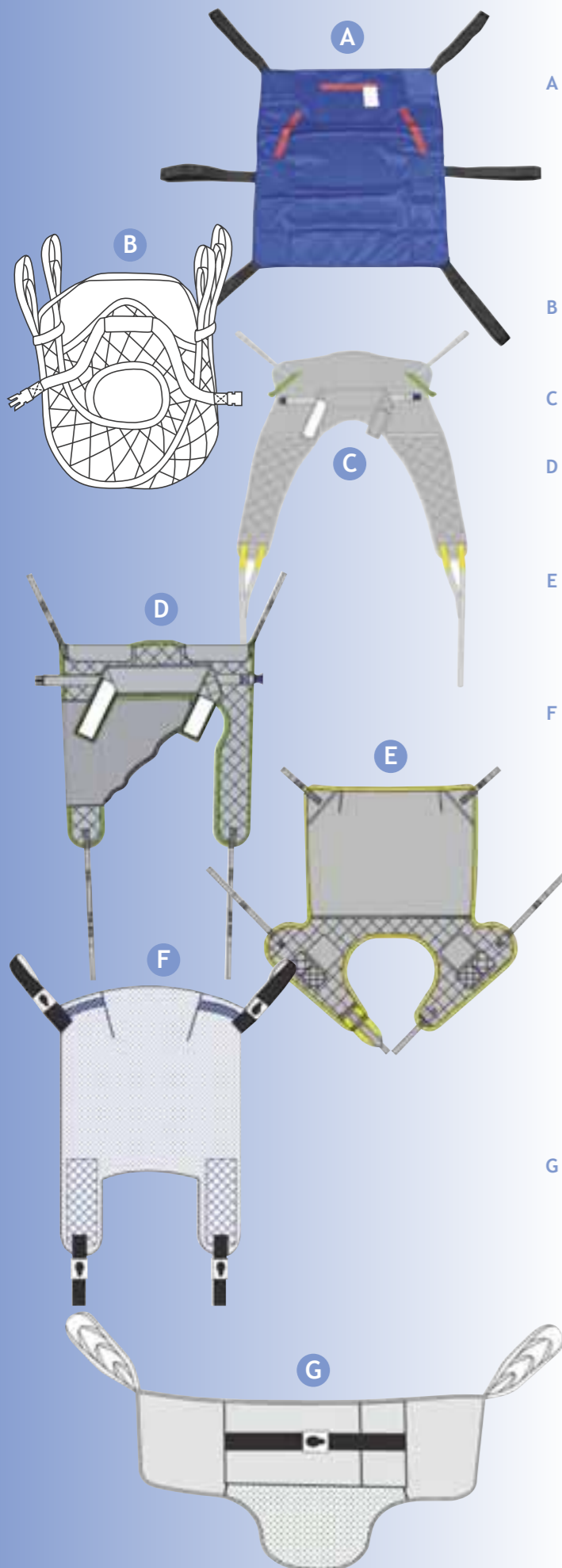

Slings (cont.)

- 069 Hammock sling - small
 - A 071 Hammock sling - medium
 - 072 Hammock sling - large
 - 069A Hammock sling with aperture - small
 - 071A Hammock sling with aperture - medium
 - 072A Hammock sling with aperture - large
- The hammock sling gives full body support and is particularly appropriate for amputees.

Amputee Slings

- B 025 **Standard amputee sling**
Made from soft towelling that covers the base of the spine, buttocks and stump, this sling is ideal for patients who need to have a sling in situ for long periods of time.
- C 025B **Amputee deluxe sling**
A very supportive sling with waist support and adjustable neck roll
- D 025C **Amputee pocket sling**
The elasticated pocket sling has soft towelling pockets to cover short amputations as well as through-hip amputations. Suitable for single and double amputees. State if pocket required at left, right, or both sides, and approximate length of amputated limb.
- E 025E **Universal amputee sling**
Ideal for below-knee amputations, with fixing straps that can be fitted to the femur, holding the limb securely in the sling.

Pivot frame slings

- F 17133 Banana Sling - small fabric
 - 17134 Banana Sling - medium fabric
 - 17135 Banana Sling - large fabric

 - 17141 Banana Sling - small mesh
 - 17142 Banana Sling - medium mesh
 - 17243 Banana Sling - large mesh

 - 17388 Banana Toileting Sling - medium fabric
 - 17389 Banana Toileting Sling - large fabric

 - 17392 Banana Toileting Sling - medium mesh
 - 17393 Banana Toileting Sling - large mesh
- The Banana sling, to be used in conjunction with a Pivoting Frame attachment, enables a patient to be lifted in either a sitting or lying position and provides added comfort, especially to obese patients.

Stand-up Slings

- G 20020 Stand-up sling - padded with loops - small
 - HLS102 Stand-up sling - padded with loops - one size
 - 20021 Stand-up sling - padded with loops - medium
 - 20022 Stand-up sling - padded with loops - large
 - HLS105 Stand-up sling - padded with clips - one size
 - 200CS Stand-up sling - padded with clips - small
 - 200CM Stand-up sling - padded with clips - medium
 - 200CL Stand-up sling - padded with clips - large
- The Stand-up sling is hook and loop fastening, and padded for comfort and support.

Sliding Products

- A 24001 Compact slide sheet 72 x 70cm
 - 24002 Standard slide sheet 122 x 71cm
 - 24003 Long slide sheet 145 x 71cm
 - 24004 Wide slide sheet 122 x 100cm
- Tubular slide sheets to ease patient movement and help carers. Formed of low friction nylon, these slide sheets make moving of a patient on a bed or similar a very easy operation, as well as assisting other horizontal slides.
- B 013 Ultra slide sheet maxi 195 x 70cm
 - 067 Ultra slide sheet maxi plus 195 x 140cm
 - 076 Ultra slide sheet mini 60 x 41cm
 - 115 Ultra slide sheet extra long 200 x 71cm
- The Ultra range of slide sheets allow three basic patient handling tasks: turning, sitting and moving, without the need to lift and without the risk of shearing to the patient's skin.
- C 116 Flat sheet 200 x 71cm
 - 128 Wide flat sheet 200 x 90cm
- Developed as an alternative to tubular slide sheets, the flat sheet incorporates a series of handholds, allowing a positive grip when carrying out a patient handling task.
- 129 Handy pack
2 flat sheets and 1 compact sheet
- D 123 Extension strap
- E 200 Standard single use slide sheet 200 x 75cm. Pk100
 - 201 Standard single use slide sheet 200 x 100cm. Pk100
- F 004 Maxi Mover quilted slide sheet 190 x 65cm
 - 013 Maxi Mover cover sheet
 - 066 Maxi Mover Plus quilted slide sheet 190 x 130cm
 - 067 Maxi Mover Plus cover sheet
 - 005 Mini Mover quilted slide sheet 70 x 65cm
 - 012 Mini Mover cover sheet
- Quilted slide sheets for turning and repositioning patients.
- G 190 Quilted Uni Slide - chair 45 x 40cm
 - 191 Quilted Uni Slide - bed 80 x 70cm
 - 192 Quilted Flat Uni Slide - chair 45 x 40cm
 - 193 Quilted Flat Uni Slide - bed 80 x 70cm
- The Uni Slide prevents patients from sliding down in a chair or bed. It allows a one directional slide (back into a chair or up the bed) then locks, preventing the patient from sliding forward.

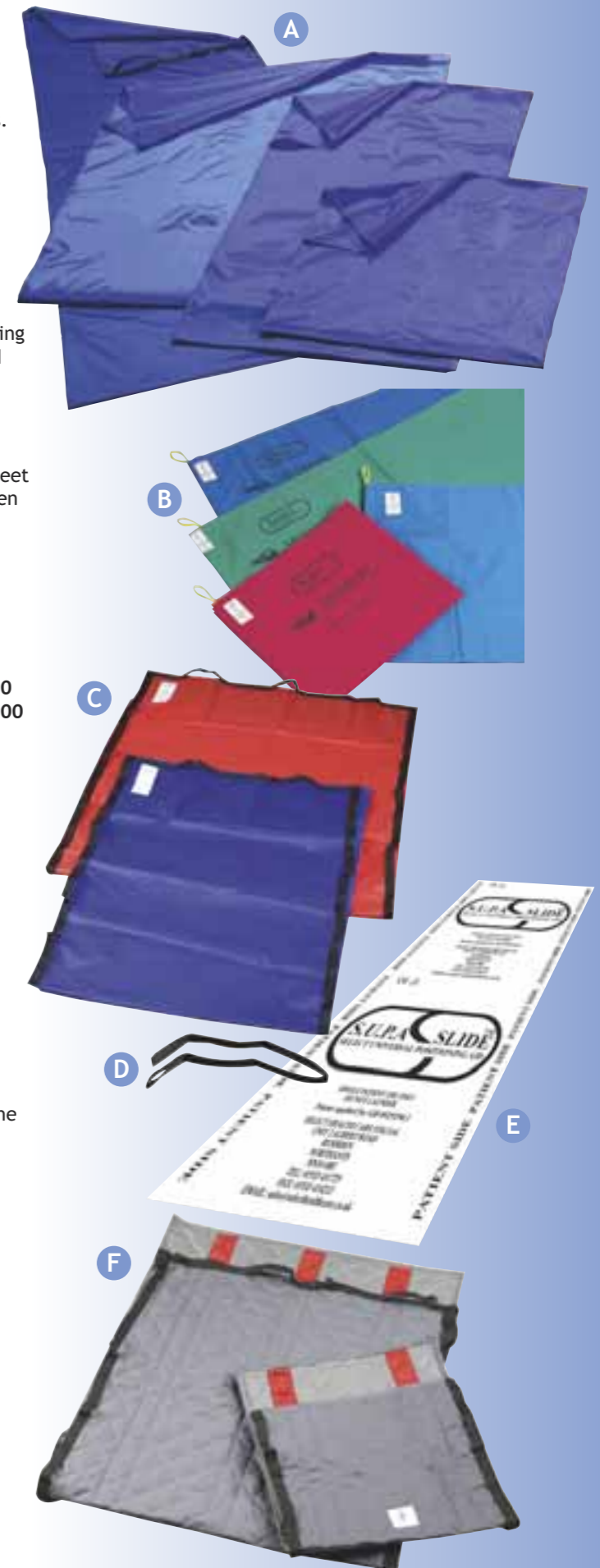



Handling Belts and Slings

- A 008 Handling sling**
A comfortable, padded handling sling which can be used for standing transfers, repositioning in bed, and leg transfers.
- B 633 Medesign sling**
The popular Medesign sling lengthens the reach of the carer, enables them to get a better grip, to pull the patient closer to them, and makes it easier to work in a more upright position. It is particularly useful when used in conjunction with sliding boards, sliding sheets, transfer boards, etc.
- C 007 Handling belt mini (Waist 20-45")**
- D 006 Handling belt maxi (Waist 24-45")**
- E 077 Handling belt maxi plus (Waist 36-60")**
- F 114 Handling belt mini deluxe (Waist 20-45")**
- G 098 Handling belt maxi deluxe (Waist 24-45")**
- H 127 Handling belt maxi plus deluxe (Waist 36-60")**
Soft, padded handling belts. The deluxe belts have a non slip inner lining and a series of vertical and lateral handholds allowing a more comfortable grip for the nurse or carer.
- I 033 Economy belt (Waist up to 45")**
A simple webbed belt with clip buckle, designed to be worn or carried by staff to ensure that there is always a handling aid to hand.

Transfer Boards and Slides

- J 119 Lateral transfer slide 185 x 65cm**
The Lateral transfer slide has a smooth surface and non slip base, allowing a patient to be transferred from one surface to another without the need to be lifted. It has tapered edges for easy insertion and removal.
- K 009 Transfer sheet 190 x 100cm**
- 205 Deluxe transfer sheet 190 x 100cm**
A full body-length sheet with handholds which aids sliding transfers between two surfaces. Weight tested to 127kg.
- L 036 Straight transfer slide 66 x 20cm**
- 037 Ultra transfer slide 66 x 20cm**
The straight transfer slide has a low friction rigid surface that will withstand weights up to 20 stone (127kg) without bending, yet it is very lightweight and easy to carry. It is of plastic construction, with a wipe clean surface that will not splinter or deteriorate in use. The Ultra transfer slide also has a pair of handling loops.
- M AA8835 Curved transfer board - blue**
The curved transfer board is designed to enable persons with limited strength and mobility to assist with functional transfers. It is ideal for car, bed chair and toilet transfers. The arc shape not only enables a variety of positioning options, but also allows for the natural sweeping pattern of an assisted transfer. It is wipe-clean and has two non-slip pads on the base of the board.
- N 401B Duo transfer slide**
- 400B Duo transfer slide deluxe**
- 402 Spare handles for above**
The Duo transfer slide allows for an angled or straight transfer from one seated position to another. The deluxe model has handgrips at either end. 150kg weight limit.

Emergency Evacuation Products

- A EVS Mattress evacuation sheet**
Used in conjunction with a standard foam mattress. During evacuation the straps are secured around the mattress and the user is evacuated safely.
- B HTE001.2 Alternating overlay evacuation sheet**
- HTE001.3 Alternating mattress evacuation sheet**
For use with all types of active pressure care systems. During evacuation the straps are secured around both the air system and the user who may then be evacuated safely.
- C HTE002 Wall mounted evacuation mattress**
A 50mm foam mattress stowed in a storage bag which is ideal for locations such as nurses stations. In the event of evacuation the mattress is simply removed from its bag, the user is placed onto it and evacuated.
- D EVO Pressure reducing overlay evacuation mattress**
- HTE006 Pressure reducing overlay evacuation mattress for 2m bed**
Dual purpose pressure reducing and evacuation devices. They are permanently installed on the bed so the user has the benefit of being nursed on a pressure reducing device which doubles as an evacuation device when needed.
- E HTE005 Vertical lift evacuation mattress**
Designed for use in the event of passenger lift failure or for lifting supine patients. With four handles on each side, weight can be evenly distributed to ensure compliance with moving and handling recommendations. It has a firm 40mm foam base with built-in stiffeners to provide maximum support and safety.
- F EVSG Evacuation sledge**
This device consists of dual inner foam, lower layer firm to ride over any surfaces, carpets, concrete or stairs whilst maintaining patient comfort. Made with safety belts and foot pocket to hold patient in place. Supplied with a wall hanging bag. For use by 2 people.
- HTE007 Stair assist evacuation device**
Ideal for those who are mobile but have difficulty using the stairs, this product has a 50mm foam base giving maximum support to evacuate safely.

Turning Products

- G 300 Rota Move**
The handlebar and rotating disc allows the client to pull or push themselves into a standing position either with or without assistance. Once stood on the rotating disc the client can be gently rotated to a different position in order to be re-seated. This prevents dangerous shuffling associated with pivot transfers. Alternatively the client can be rotated and sat on the Rota Move seat. Once on the Rota Move seat, a nurse or carer can transport the client safely to bathroom, toilet, bedroom etc. The height adjustable seat and side flaps allow for a side transfer to and from different height surfaces. Simply adjust the height of the seat to the surface you are transferring on or off. Ideal for those with limited weight bearing capability.
- H 102 Rota Stand**
This Stand allows a safe, smooth and controlled swivel transfer. It reduces the need to 'hold' a patient during a transfer and it encourages an independent and dignified transfer.
 - Height adjustable frame to suit all
 - Foot pedal break to secure turn-table
 - Central wheels for easy positioning
 - Angled shin pad for correct standing position
 - 160 kg weight limit





Turning Products

- A LOCO-311 Rota Stand Solo**
The Rota Stand Solo is built to the same design as the Rota Stand, but with the addition of a patented T bar stabilising mechanism which allows a sit to stand and pivot transfer to be carried out by a single carer.
- B LOCO-034 Fabric turntable 300mm dia.**
LOCO-035 Fabric turntable 380mm dia.
LOCO-038 Plastic turntable 300mm dia.
LOCO-039 Plastic turntable 380mm dia.
Available in two sizes with a non-slip base and cushioned surface, the turntable allows patients to be moved from bed to chair, wheelchair or commode safely.
- C LOCO-068 Rota cushion - standard 300mm dia.**
LOCO-078 Rota cushion - large 450mm dia.
Soft padded flexible turning discs ideal for use on car seats, chairs and beds. The Rota Cushion allows a smooth swivel transfer without painful jarring and twisting.

Other Products

- D LOCO-082 Manual handling bag**
If you work in the community and have to carry equipment around with you or if you simply want to be able to put equipment away and keep it clean and tidy after use, then the Manual Handling Bag is a useful accessory.
- E LOCO-014 Chair trolley**
Developed to help hospital and care home staff move heavy day chairs or stacks of chairs without the need to lift.
 - Greatly reduces risk of back injury
 - Stands upright when not in use
 - Plate width for chair: 69.5cm
- F LOCO-302 Limb support**
The Limb Support has been developed to combat manual handling problems associated with supporting a patient's arm or leg whilst attempting to dress or treat the limb. It is height adjustable and comes complete with 20 disposable support covers.

LOCO-303 Disposable covers Pk20
Extra disposable covers for the Limb Support above.
- G LOCO-121 Bed pull**
A simple construction of webbing loops which can be hooked underneath the leg or castor of a bed and allows a patient to pull themselves into a sitting position. Length 200cm, weight limit 175kg.
- H LOCO-122 Leg raiser**
For those who cannot raise their legs into a bed or onto a footstool, the leg raiser incorporates a foot stirrup which can be placed over the foot by the user, and a long rigid handle which allows the user to raise the leg without the need to bend. Length 103cm.

LOCO-117 X-Ray cassette sleeve 43 x 43cm
LOCO-118 X-Ray cassette sleeve 50 x 43cm
LOCO-126 Quilted X-Ray sleeve 51 x 43cm
The X-Ray cassette sleeve is a tubular slide sheet, which when placed around the X-ray cassette allows it to slide easily beneath a patient. The quilted version has added handholds for ease of use.

Bedding & Towels

Bed Pads

Floor and Chair Pads

Adult Clothes Protectors

Duvets

Pillows

Bedding

Community and Care Towel Range

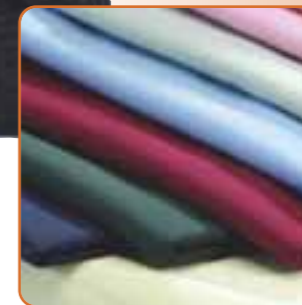
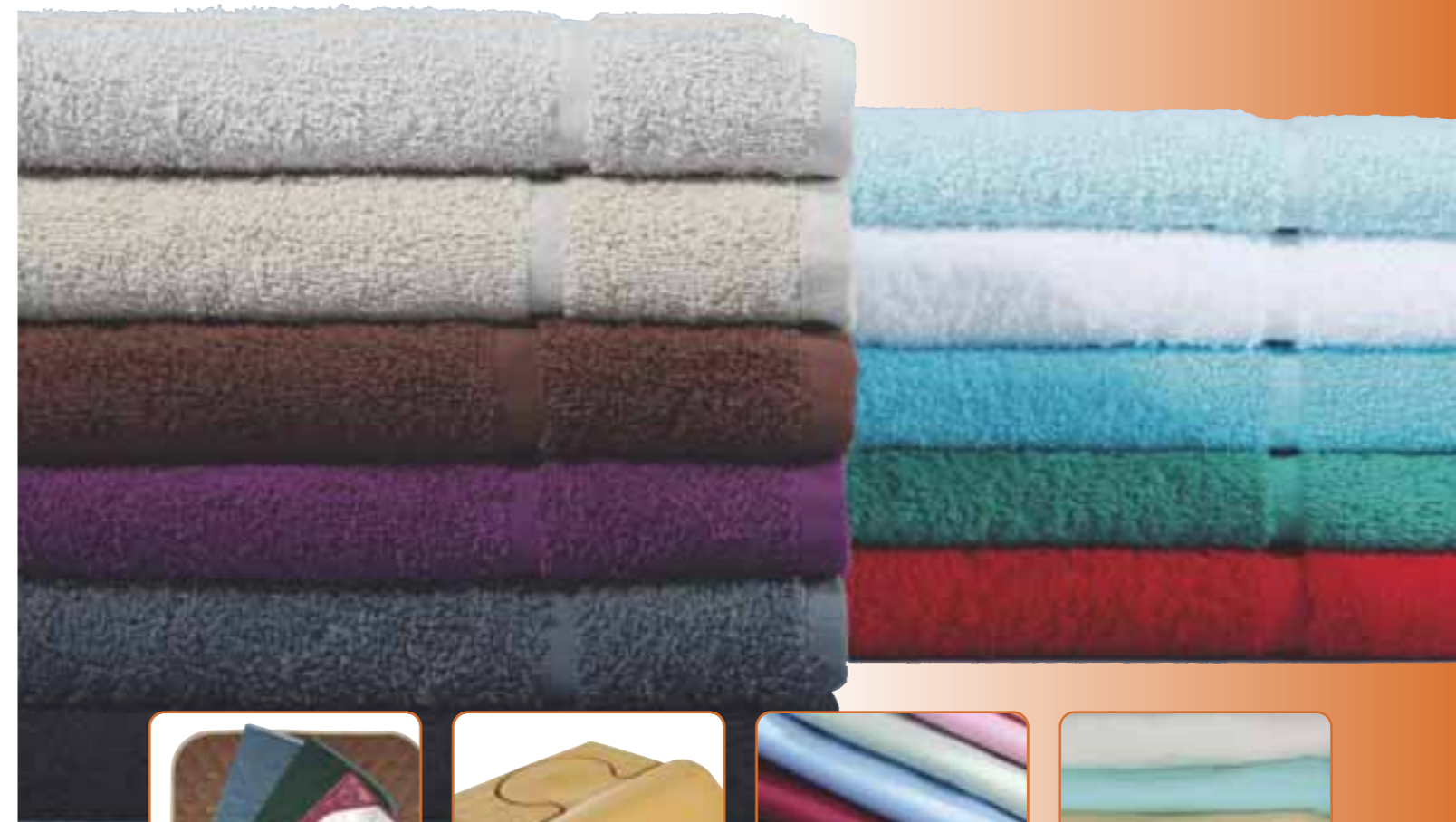

Our bedding and towel ranges offer nursing convenience, patient care and excellent value for money.



Incontinence Bed Pads

- A** 2001/4 Community bed pad
2001/4/F Community bed pad with flaps
70 x 85cm. Stay dry 2 litre capacity.
- B** DBP32-Flaps OCEAN bed pad with flaps - lilac
82 x 82cm. Stay dry 3.2 litre capacity.
DBP25-FLAPSOCEAN bed pad 2.5L with flaps
Stay dry 2.5 litre capacity
- 2002/1/BL Sanoma bed pad - white
2002/1/F Sanoma bed pad with flaps - white
85 x 90cm. Stay dry 3 litre capacity.
- D** 1108/A/B Sanoma double bed pad - pink
85 x 112cm. Stay dry 3.5 litre capacity.
- 2011 Chamois bed pad Ultra
2011/F Chamois bed pad Ultra with flaps
85 x 90cm. Stay dry 3.5 litre capacity.
- 2018/A/SL/F Chamois double bed pad Ultra with flaps
85 x 115cm. Stay dry 4 litre capacity.



The 'stay dry' surfaces of these Bed Pads promotes healthy skin, the compact soaker layers providing fast and efficient absorbency. Having 100% absorbency creates an impermeable barrier which protects the bedding, as well as resisting stains and bleach. These Bed Pads can be washed over 300 times which eliminates the need for drawsheets and disposables.

E TDS Twill draw sheet
Unbleached cotton. 115 x 185cm.

Chair and Floor Pads - Washable

- F** 1105/A/B Sanoma chairpad
G 54 x 58cm. Available in pink.
- H** 831BSP4960 Chairpad
49 x 60cm. Available in blue
- I** 1800* Dura velour chairpad
50 x 60cm. *Colours available: Blue 1 - Green 2 - Lilac 3 - Brown 4
- MP1623* Velour chairpad 40 x 50cm
MP2123* Velour chairpad 54 x 58cm
MP2135* Velour floorpad 90 x 135cm
*Colours available: Green(G) Maroon(M) Blue(BL) Brown(B)





Adult Clothes Protectors

- A ACP*** Adult clothes protector
These 46 x 92cm protectors are bleach resistant and hold a colourfast soaker layer. Being long lasting, they're very cost effective, available in a range of designs. An inbuilt fluid proof barrier protects clothing and these protectors can wash up to 95°C and tumble dry on a medium heat setting.
*Colours available: Gingham G - Blue Stuart BS - Green Stuart GS Villa Metro VM - Yellow Check YC - Floral F - Bahama Bazaar BB
- B ACP-REDT OCEAN** adult clothes protector
ACP-BLUE OCEAN Clothes protector - Blue 90cm
- C HTP301*** Terry Dribbler clothes protector
- D HTP302*** Terry Standard clothes protector
- E HTP303*** Terry Long clothes protector
*Colours available: Blue(B) Green(G) White(W)

F.R Duvets

FR to BS7175 Source 5

- F BD** FR budget single duvet
Green polypropylene with a 10.5 tog rating
- VPD001** FR PU waterproof/v.permeable duvet - single
10.5 tog rating
- PWD4** FR machine washable single quilted duvet
10.5 tog rating
- CPD** FR cotton single duvet
10.5 tog rating, non-waterproof

The waterproof duvets have been designed with comfort for patients and time saving for nurses in mind. The duvet eliminates the need for laundering, as the bedding simply requires wiping down with a mild detergent, ensuring they stay on the ward, offering continuity of care. This bedding range offers nursing convenience, patient care and excellent value for money. The duvet is very soft and silent, and offers freedom of movement due to its light weight, whilst ensuring patient warmth.

Duvets FR to BS7175 Source 2

- SD** Single duvet 10.5 tog
- DD** Double duvet 10.5 tog
- KS** King size duvet 10.5 tog



F.R Pillows

- A VPP001** FR Vapour permeable wipe clean pillow
The Vapour permeable pillows are to the same specification as the duvets.
- B BP** FR Budget pillow
- C CPP** FR Cotton pillow (not waterproof)
- D PWP4** FR Machine washable single quilted pillow
- VSP001** FR V-Shaped pillow (not waterproof)
- E HFV080** FR Vapour permeable wipe clean V-shaped pillow
- HFV124** FR Vapour permeable wipe clean large V-shaped pillow
The V-shaped vapour permeable pillows are to the same specification as the duvets.

- F HGC215** FR Alova occipital pillow
The Alova Occipital Pillow is protected by a protective coating ensuring high tear resistance and enhanced hygiene. Particularly suited to patients immobilised in the supine position. Specially designed to decrease pressure sore risk of the occiput (back of head) and ear lobes. The anatomical foam cushions the nape curve, gives good cervical support and provides a comfortable resting position.

- G HGC216** FR Axis Alova cervical pillow
The Alova Cervical Pillow is a viscoelastic anatomical product made of Alova covered in a dual membrane layer. The two differing heights of cervical contour allow a choice to establish the one which best adapts to the anatomy of the patient.

- H HF072** FR Caspian pillow
A convoluted back support pillow offering additional back/neck support covered in a two-way stretch vapour-permeable material.

- I HF123V** FR Visco foam pillow
Moulded visco foam inside a vapour permeable cover.

J FR Waterproof Bedding Protection

These products have no elastic which improves their longevity, while their 4 way stretch fabric minimises creasing and rucking. As well as being fluid proof, dustmite proof and Hypo-Allergenic, they are also breathable whilst remaining discreetly quiet and comfortable.
Easy care - can be washed up to 95C and tumble-dried on a medium heat setting, or alternatively, just wipe clean.

- V11** Waterproof pillow protector
- V8** Waterproof mattress cover fitted - single
- ES75367** Waterproof mattress protector envelope - single
- ED75546** Waterproof mattress protector envelope - double
- ES75607** Waterproof mattress cover envelope - king
- V10** Waterproof duvet protector - single
- ED7878** Waterproof duvet protector - double
- ES6636** Waterproof drawsheet
- 130/WPU** PU Vapour Permeable pillow protector
- 124/WPU** PU Vapour Permeable mattress protector envelope - single





Non FR Polycotton Bedding

The following Bedding accessories are available in Pastel or Deep colours, as well as a range of sizes available by request. These items are not flame retardant, and sizes and manufacture is as per Flame Retardant.

- PCFI* Polycotton fitted sheet - single
- PCFL* Polycotton flat sheet - single
- PCDC* Polycotton duvet cover - single
- PCBV* Polycotton base valance - single
- PCVS* Polycotton fitted valance sheet - single
- PCPC* Polycotton pillowcase
- PCVP* Polycotton V-pillowcase

*Colours available:
 Pastel colours: White W - Cream C - Peach PE - Pink PI - Lemon L
 Light Blue B - Light Green LG
 Deep colours: Burgundy BU - Navy N - Dark Green DG

FR Bedding - Polyester

- FRPFI* FR Polyester fitted sheet single
- FRPFL* FR Polyester flat sheet single
- FRPPC* FR Polyester pillowcase
- FRPDC* FR Polyester duvet cover envelope end single
- FRPBV* FR Polyester base valance 15" single
- FRPFV* FR Polyester fitted valance sheet single
- FRPVP* FR Polyester V-shaped pillowcase

*Colours available:
 Deep colours: Burgundy BU - Navy N - Dark Green DG

FRT* FR Throwover 195 x 265cm single
 Throw colours: Cream C - Peach P - Dusky pink DP - Gold G - Blue B - Green G

Double bed sizes available - please enquire

*Colours available:
 Pastel colours: White W - Cream C - Peach PE - Pink PI - Lemon L
 Light Blue B - Light Green LG
 Deep colours: Burgundy BU - Navy N - Dark Green DG

Berkeley Collection

An exciting range of printed fabrics available as bedding and curtains - call our sales office for details

A FR Sleep Knit 2 Way Stretch Bedding

These products are made of specially knitted polyester fabric for performance and comfort. Their 4 way stretch fabric minimises creasing and rucking, yet their innovative design requires no elastic. Easy care - no ironing or folding required, and can wash up to 95C and tumble-dried on a medium heat setting.

- SKBS* Sleepknit bottom fitted sheet - single
- SKBSD* Sleepknit bottom fitted sheet - double
- SKTS* Sleepknit top flat sheet - single
- SKTSD* Sleepknit top flat sheet - double
- SKDC* Sleepknit duvet cover - single
- SKPC* Sleepknit pillowcase
- SKVP* Sleepknit V-shaped pillowcase

*Colours available: White W - Cream C - Blue B - Green G
 Yellow Y - Peach PE - Pink PI

B Community Towel Range (400g)

- CFC* Face cloth 30cm x 30cm (12)
 - CHT* Hand towel 50cm x 90cm (6)
 - CBT* Bath towel 70cm x 137cm (6)
 - CBS* Bath sheet 100cm x 150cm (3)
- *Colours available: White W - Cream C - Peach PE - Pink PI
 Light Blue B - Light Green LG

- CBM* Bath mat 50cm x 70cm (1)
- *Bath Mat colours: White W - Cream C

C Care Towel Range (500g)

- FC/colour Face cloth 30cm x 30cm (12)
 - HT/colour Hand towel 50cm x 90cm (6)
 - BT/colour Bath towel 70cm x 137cm (6)
 - BS/colour Bath sheet 100cm x 150cm (3)
 - BM/colour Bath mat 50cm x 70cm (1)
- *Colours available: (Pastel) White W - Cream C - Peach PE
 Pink PI - Light Blue LB - Light Green LG - Stone S -
 Wild Mushroom WM - Aqua A - Turquoise T - Lemon L - Lilac LI
 (Deep) Terracotta TE - Wine WI - Dusky Pink DP - Navy N
 Dark Green DG - Red R - Emerald E - Chocolate CH
 Charcoal CHA - Black B



Nursing Equipment

- Bathing Equipment
- Patient Scales
- Commodes and Shower Chairs
- Wheelchairs
- Beds and Accessories
- Trolleys
- Record Books
- Thermometers
- Nebulisers and Suction Machines

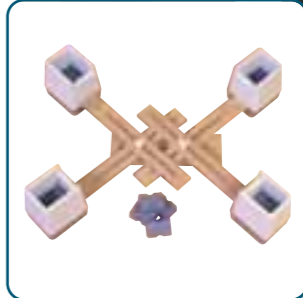

“ Andway Healthcare supply a comprehensive range of Nursing Equipment for all situations from your large equipment requirements to small ADL items. ”

Bath Seats

- A 591** Slatted bath seat (6")
 - 592** Slatted bath seat (8")
 - 871** Slatted bath seat (12")
- Lightweight, and easy to lift in and out of the bath, with large sucker feet and secure slip-resistant fitting.
- B AA1130** Derby bath seat (6")
 - AA1132** Derby bath seat (8")
- Lightweight, with large sucker feet and secure slip resistant fitting. Made from injection moulded plastic with a textured seat area.
- C 536** Rotating bath seat
- A rotating bath seat which locks at 90 degree intervals, with an aluminium frame which locates on the side of the bath. It is available in 4 sizes, to suit different bath widths, with side arms for extra security and drainage holes in seat.
- D 807A** Bath seat (6")
 - 807B** Bath seat (8")
- This bath seat has a contoured plastic seat with a partial cutaway for easier personal cleansing. The sturdy leg design and plastic suckers ensure safety in use.

Bath Boards

- 579A** Slatted bath board (26")
 - 579B** Slatted bath board (27")
 - 579C** Slatted bath board (28")
- Lightweight, easy to lift on and off bath, and with an all plastic slatted construction.
- E 587** Bath board with handle
- Adjustable in width and made from lightweight moulded plastic. Includes a handle to assist user on/off the board, a built in soap dish, and drainage holes in seat.

Bath Mats

- AA1802Y** Rubber bath mat - small (570x355mm)
- AA1804A** Rubber bath mat - large (760x350mm)
- AA1794** Square shower mat - (540x540mm)

Bath Accessories

- G 854** Inflatable hair wash basin
- H 810** Long handled sponge 38cm (15")
- I 811** Long handled sponge 57.5cm (22")
- J 812** Long handled toe washer 71cm (28")
- K 813** Foot brush and sponge

Bars and Rails

- A 4230** Drop down grab rail - loop type
 - B 4231** Drop down grab rail with adj. leg
- C 562** Floor mounted Swedish bath rail
- Chrome plated bath rail. Fitted with slip resistant rubber pads, and floor fixing flanges for additional security.
- D 553** Powder coated bath rail
- A hinged support rail which lifts above taps when not in use.
- E 560A** Economy grab rail (18")
 - 560B** Economy grab rail (24")
 - 560C** Economy grab rail (27")
- Powder coated grab rails manufactured from 2.5cm diameter steel tubing. Pre-drilled fixing holes with flat fixing plates.
- F 567A** Chrome plated steel grab rail (12")
 - 567B** Chrome plated steel grab rail (18")
 - 567C** Chrome plated steel grab rail (24")
 - 567D** Chrome plated steel grab rail (36")
- Manufactured from 2.5cm diameter steel tubing, with pre-drilled fixing holes in flanges.
- G 568A** Powder coated steel grab rail (12")
 - 568B** Powder coated steel grab rail (18")
 - 568C** Powder coated steel grab rail (24")
 - 568D** Powder coated steel grab rail (36")
- Manufactured from 2.5cm diameter steel tubing, with pre-drilled fixing holes in flanges.
- H 584A** Plastic fluted grab rail with flange cover (12")
 - 584B** Plastic fluted grab rail with flange cover (18")
 - 584C** Plastic fluted grab rail with flange cover (24")
- Made from white ABS plastic with circular fixing plates and plate covers. Fluted plastic to provide a better grip.
- I 568ANG** Plastic coated angled rail
- Manufactured from 2.5cm diameter steel tubing with pre-drilled fixing holes in flanges. 90 degree angle.
- J 585A** Blue plastic fluted grab rail with flange cover (12")
 - 585B** Blue plastic coated grab rail with flange cover (18")
 - 585C** Blue plastic fluted grab rail with flange cover (24")
- Made from ABS plastic with circular plastic fixing plates and white flange covers. Fluted plastic to provide a better grip.
- K 568NL** Newel rail - left handed
 - 568NR** Newel rail - right handed
- Manufactured from plastic coated 2.5cm diameter steel tubing.

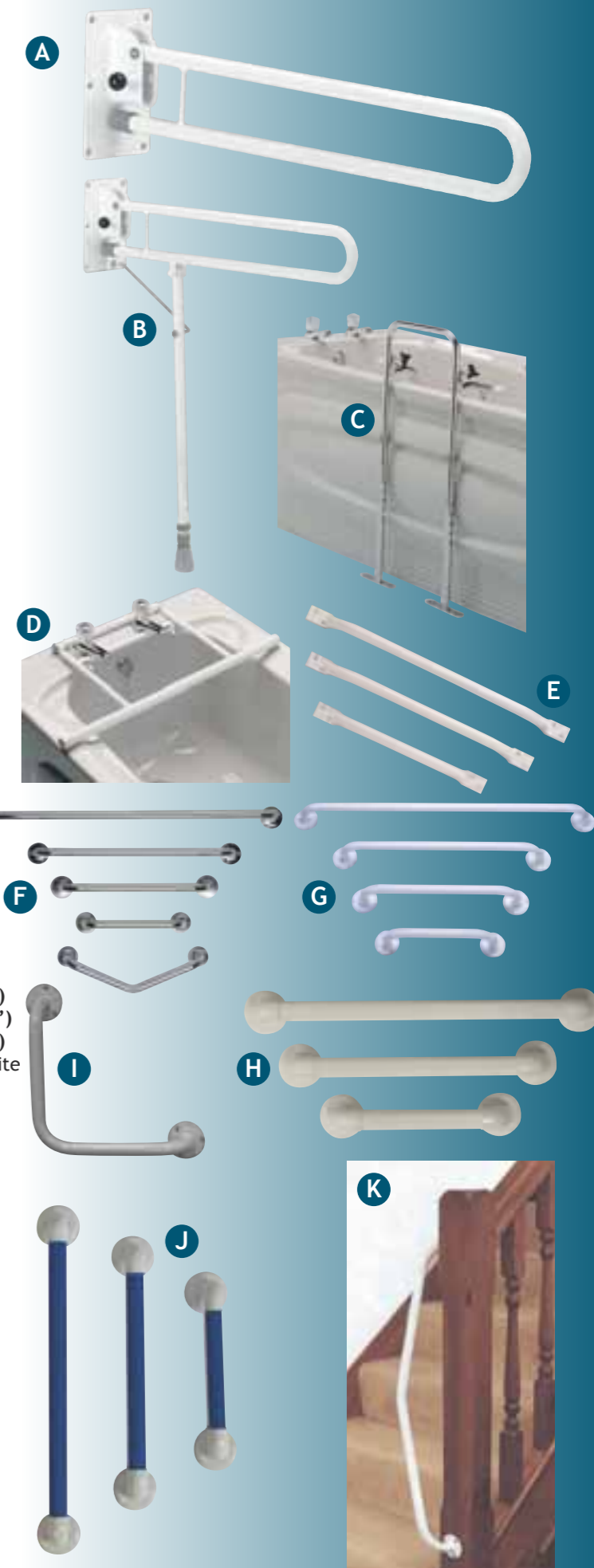
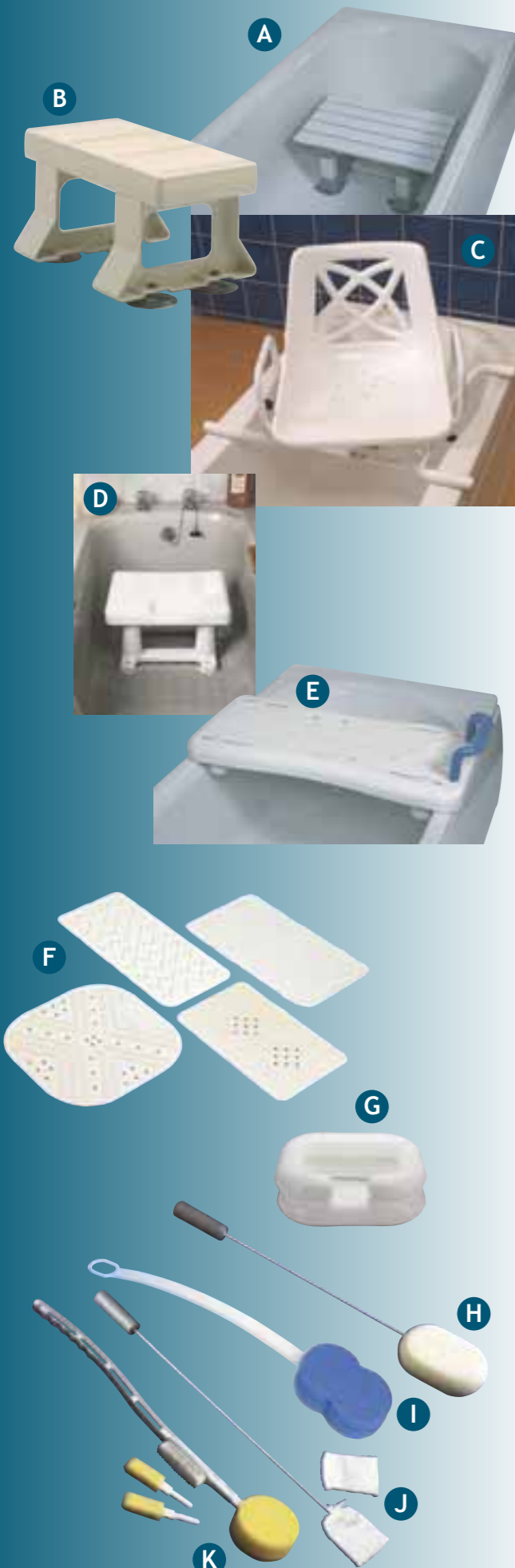

Bars and Rails (cont)

- A 726A Prima white/green grab rails (12")
- 726B Prima white/green grab rails (18")
- 726C Prima white/green grab rails (24")
- 726ANG Prima white/green grab rails (13" angled)

- 834A Prima white grab rail (12")
- 834B Prima white grab rail (18")
- 834C Prima white grab rail (24")
- 834ANG Prima white grab rail (13" angled)

The Prima grab rails feature special soft grip mouldings around the bar to reduce the risk of slipping, even with wet soapy hands. The bars are strong, one-piece moulded plastic with the super reinforced strength of an internal non-rust aluminium tube. The ergonomic grip is comfortable and never cold to touch, unlike most metal grab bars.

Legrests

- B 600 Cardiff adjustable height legrest
- 600C Cardiff adjustable height legrest with castors

Patient Scales

- C 590J/BMI Weymed mobile sit-on scales
Mains/Battery - 200kg capacity. These robust scales are compactly designed and easy to manoeuvre. With body mass index facility, back lit display, retractable foot rest and power from a rechargeable battery. A charging adaptor is provided.
- D 590/BMI Weymed mobile digital deluxe sit-scale
Mains/Battery, 200kg capacity with a large, backlit multi-display to show weight, height and body mass index, with an indicator head that can be adjusted to any convenient angle. The chair is spacious and comfortably accommodates overweight patients. A charging adaptor is provided.
- E 890/BMI Weylux mobile digital sit-on chair scale
Mains - 250kg capacity. Strong steel manoeuvrable trolley fitted with braked castors. Optional seat belt for the disabled.
- F MS5400 Marsden bariatric chair scale with BMI
This chair scale has a 300kg capacity, with an extra wide, strong seat with reinforced framework. Fitted with body mass index function and with a data out port for connection to Datac Printer.
- G 90 Weylux mobile mechanical sit-on chair scale
Accurate 160kg capacity traditional beam scales with swivel arm rests and retractable foot rest.
- H 524/BMI Weymed digital stand on scale
Robust scales with a large, backlit multi-display to show weight, height and body mass index. The 460 x 330mm stainless steel platform can accommodate very large patients. The indicator head can be adjusted to any convenient angle. Power is from a long life re-chargeable battery and a charging adaptor is provided. The scale has a 250kg capacity.

Patient Scales

- A 524J/BMI Weymed digital transportation stand on scale
This model is identical to 524/BMI but height is reduced to 340mm. Fitted with a robust handle these scales are very easy to carry. Mains/Battery - 250kg capacity
- B HWS Marsden hoist weigher attachment with BMI
The Marsden hoist weigher has a capacity of 200kg. This new lighter hoist weigher attachment fits most types of hoists that have a 'coat hanger' type sling support. Safety clips included to secure sling straps. Fitted with body mass index function. Height 180mm, length 640mm. Rechargeable battery and charger supplied.
- C MPWS300 Marsden portable wheelchair weigh beams with BMI
Two portable weigh beams with remote digital readout. Tare facility and body mass index function. Capacity 300kg x 100kg. Mains/Rechargeable battery, charger supplied.
- D MPWC300 Marsden professional wheelchair weigher with BMI
This wheelchair weigher has a lightweight aluminium design with a lower profile platform that can be folded up for easy transportation and storage. Roll on and roll off sides for easy access. Digital tare, and body mass index function included. Fitted with data out port for connection to Datac Printer. 300kg capacity. Mains/Rechargeable 'on board' batteries (charger supplied).

Stationary Commodes

- E ASC001 Community stacking commode
Height: 81.5cm
Max user weight: 160kg (25st)
- 51318 Deluxe chrome plated steel static commode (18")
- F Adjustable height commode with swinging drop arms, which can be detached for side transfer. Includes hook-on footrests and detachable back. Easy to clean hygienic blow moulded aperture seat with removable square bowl. With moulded armrests and upholstered back and seat.
- 521A Adjustable height stacking commode
- G 521AD Adjustable height stacking commode with arms
Adjustable height commode with a powder coated dark blue frame which can be stacked up to 10 high. Clip-on toilet seat for ease of cleaning, with a light blue padded overseat and back rest. Removable round bowl with lid and handle.
- 521AHD Heavy duty adjustable height commode chair with detachable armrests
Powder coated steel frame with slip resistant rubber tips.
- H 847 Folding commode chair and toilet surround
Supplied with pot for commodes and sleeve for toilet surround. Lightweight aluminium adjustable height frame. Clip-on toilet seat, can easily be taken off for cleaning. Clip on backrest for additional support. Folds easily for storage/transportation.
- I 524 Bedside commode
Can be fitted to side of divan bed to enable patient to side transfer. Adjustable height with hygienic blow moulded seat and padded upholstered removable overseat. Square bowl is easily removed from side of chair. May be used on single or double beds.





Mobile Commodes

- A AMC001** Commode chair with 4 castors and toilet pan
A robust wheeled commode, with a simple but functional design.
Seat width: 45cm
Seat height: 49cm
Max user weight: 21st / 135kg
- B 512DABPH** Chrome plated steel mobile commode with round bowl
512PSB Chrome plated steel mobile commode with square bowl
Sturdy chrome plated steel construction. Detachable arms enable patient to side transfer. 4 swivel brake castors and padded overseat. Hygienic blow moulded easy to clean aperture seat. Pushing handle fitted as standard. Can be wheeled over a standard toilet.
- C 84518** Deluxe chrome plated steel mobile commode - standard (18"), chrome plated
84520 Deluxe standard plated steel mobile commode - heavy duty (20"), standard plated
84522 Deluxe standard plated steel mobile commode - heavy duty (22"), standard plated
Adjustable height commode with swinging drop arms, which can be detached for side transfer. 4 swivel brake castors, hook-on footrests, and detachable back with built in pushing handle. Easy to clean hygienic blow moulded aperture seat with removable square bowl. Moulded armrests and upholstered back and seat.
- D 599** Atlantic mobile commode and shower chair (18")
599F Atlantic mobile commode and shower chair with footrests (18")
599FTB Atlantic mobile commode and shower chair with footrests, toilet roll holder, bottle holder and rear basket (18")
599DPR Atlantic mobile commode and shower chair with disposable pan rack
599FDPR Atlantic mobile commode and shower chair with footrests and disposable pan rack
The hygienic white clip-on backrest and detachable arms can easily be removed for cleaning. An optional perfection pan rack enables the chair to be used with a re-useable or disposable bed pan.
- 598** Atlantic Bariatric mobile commode and shower chair (20")
598F Atlantic Bariatric mobile commode and shower chair with footrests (20")
598X Atlantic Bariatric mobile commode and shower chair (22")
598XF Atlantic Bariatric mobile commode and shower chair with footrests (22")
All castors are fitted with brakes for additional safety. The multi function innovative arms are: swing back; drop down; detachable and come complete with a new design easy to operate hygienic arm catch. White aperture seat, backrest and armrests can all easily be removed for cleaning. With detachable back and optional rear basket.
- E ACC/10** Hook-on footrests for 512 range
F ACC/17 Round bowl and lid for 512DABPH
PL512 Square bowl and lid for 612PSB
- G ACC/2** Perfection pan rack for deluxe range
Accommodates the perfection bed pan.
- H 640** Perfection bed pan

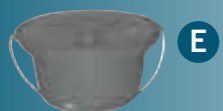

Mobile Commode and Shower Chairs

- A 841** Self-propelled commode and shower chair
Lightweight powder coated aluminium frame with adjustable height detachable armrests for side transfer. Chair fits over standard toilet bowls and has swing-away detachable footrests and self propelling rear wheels. Pushing handle enables Carer to transport patient with ease. Round bowl and lid. 2 swivel brake castors for additional safety.

Height: 99cm
Seat height: 54cm
Max user weight: 125kg (25st)
- B 577RB** Attendant-propelled gull wing commode and shower chair
Multi-purpose with heavy duty weight capacity of 140kgs. Manufactured from plastic coated steel tubing with flip-back gull wing style armrests, pushing handle and cellular moulded seat. Round bowl fitted as standard. Can be wheeled over a standard toilet. Complete with 4 swivel brake castors and fold-away footrest.
- C 544B/BOWL/4BC** Aluminium commode and shower chair
Lightweight and rust proof, with 4 swivel brake castors and pushing handle. Anodised aluminium frame with lift up blow moulded aperture seat.
- D 519** Royale wooden commode chair
Ideal for living room or bedroom, with a solid beech frame and padded upholstered back and seat. Comfortable, hygienic, locking potty design with wide commode plastic seating area. Available in dark pink/blue/green and brown upholstery.
- E 733** Royale flushing commode chair
The Royale flushing commode's innovative design combines the benefits of the Royale Commode with the convenience of a hygienic flushing potty. The WC can be used multiple times before the potty has to be emptied. The discreet holding tank slides out of the commode's base for waste disposal and easy cleaning.
- F 519B** Basket Weave commode chair
Strong beech frame with padded upholstered seat and strong splayed hardwood legs. Comfortable, hygienic, locking potty design with wide commode plastic seating area - easy to clean. Permanent anti-bacterial action in seat.

09 115 6645 Softgrip hand crutches - turquoise

Furniture Commode

- G Epsom commode chair**
Width 21" Depth 21"
Height 31"





Stationary Shower Chairs and Stools

- A BE03W Adjustable height aluminium shower chair**
Adjustable height shower stool with plastic seat with cutaway front for personal cleaning. Side arms are standard to make it easier for patient to raise and lower themselves from the seat, and back support gives additional stability. (This item is supplied flat packed, with easy to follow assembly instructions - tools supplied.)
- B BE04W Folding aluminium shower chair**
Adjustable height shower chair with plastic seat with cutaway front for personal cleaning. Side arms make it easier for patient to raise and lower themselves from the seat and back support gives additional stability. (This item is supplied flat packed, with easy to follow assembly instructions - tools supplied.)
- C 539PBHD Extra wide shower chair with detachable back**
Adjustable height shower chair with extra wide seat (61cm) and detachable back.
- D 597A Adjustable height shower chair**
- E 597 Stationary shower chair**
Plastic coated steel frame with fixed armrests and white plastic seat with drainage holes. Slip resistant rubber tips. Attractive speckled finish.
- F 545HD Heavy duty stationary shower chair**
Plastic coated steel frame with fixed armrests and extra wide spacing. White plastic seat with drainage holes. Slip resistant rubber tips. Attractive speckled finish. Heavy duty weight capacity - 160kgs.
- G BE01W Height adjustable aluminium shower stool**
- H BE02W Adjustable height aluminium shower stool with arms**
Shower stool with plastic seat with cutaway front for personal cleaning. (This item is supplied flat packed, with easy to follow assembly instructions - tools supplied.)
- I BE11W Corner shower stool**
(This item is supplied flat packed, with easy to follow assembly instructions - tools supplied.)
- J BE10LW/RW Fold down corner shower seat with drop down leg - left handed / right handed**
Aluminium corner fold down wall fixing shower stool with adjustable height leg, supplied with a plastic seat. When looking into the corner of the shower cubicle, if the bracket needs to be fitted to the left hand side, order BE10LW. If the bracket needs to be fitted to the right hand side, order BE10RW.
- K 537B Shower stool**
Lightweight, adjustable aluminium frame with non-marking, slip-resistant rubber feet. Blow moulded plastic textured seat with built-in handles.
- L 537A Deluxe shower stool with backrest**
Lightweight, adjustable aluminium frame with non-marking, slip-resistant rubber feet. Blow moulded plastic textured seat with built-in handles. Adjustable backrest.
- M 539L Lightweight adjustable height shower stool**
This lightweight aluminium frame comes with an adjustable clip on the plastic seat which can be removed for cleaning. Handles on the side of the seat provide additional support.
- N BE07W Aluminium fold down shower seat with drop down legs**
Aluminium fold down wall fixing shower seat with adjustable height legs. The seat has a gap in front for personal cleaning.

Wall Mounted Shower Seats

- A 538D Wall mounted shower seat with drop down legs**
Powder coated steel frame with blow moulded plastic seat for easy cleaning. Can be folded flat against the wall when not in use. Handles on the seat provide extra security for the user and the fold-down adjustable height legs create extra stability where wall construction does not allow an unsupported seat. With non-marking, slip resistant rubber tips.
- 538L Aluminium wall mounted shower seat**
Lightweight aluminium frame and easy to clean blow moulded plastic seat with handles. Space saver - folds flat against the wall when not in use.
- 538DL Aluminium wall mounted shower seat with drop down legs**
Lightweight aluminium frame and easy to clean blow moulded plastic seat with handles. Fold-down adjustable height legs with non-marking slip resistant rubber tips. Space saver - folds flat against the wall when not in use.
- B 538 Wall mounted shower seat**
Robust powder coated steel frame and easy to clean blow moulded plastic seat with handles. Space saver - folds flat against the wall when not in use.

Mobile Shower Chairs

- C 546B Mobile shower chair**
546B/ADJ/4BC Mobile shower chair adjustable height
546BD/4BC Mobile shower chair with detachable arms
Plastic coated steel frame with fixed or detachable armrests and white plastic seat with drainage holes. Easy manoeuvrability with 4 swivel brake castors.

Raised Toilet Seats

- D AWCS02 Raised toilet seats with easy fittings (2")**
- AWCS04 Raised toilet seats with easy fittings (4")**
- AWCS06 Raised toilet seats with easy fittings (6")**
Attractive, recyclable natural finish in a one piece moulding which can be totally immersed for cleaning. With easy to fit plastic screw clamps and a wide frontal opening.
- E 632A Raised toilet seat (4")**
- 632AD Deluxe raised toilet seat with lid (4")**
Polypropylene raised toilet seat 10cm (4") with or without lid, and complete with 2 fixings.
- F 790 Clip-on raised toilet seat**
Lightweight portable raised toilet seat which easily clips on to the WC.
- G P2010044000 Continental raised toilet seat with lid**
- H 862 Bidet bowl**
The ideal solution to personal cleansing. The Bidet bowl fits inside the toilet bowl converting a standard toilet to a bidet. Please note this product is not suitable for use with raised toilet seats.



Toilet Aids

- A 503A** Powder coated adjustable height toilet surround
- B 503AHD** Extra wide toilet surround adjustable height
Adjustable height powder coated toilet seat with moulded plastic armrests for additional support. With non-marking, slip resistant rubber tips.
- C 499** Toilet seat aid
This new clip on toilet seat is unsurpassed in the level of comfort and postural support it provides as the seat surface itself is greater in area than in most seats on the market. It also features cut-outs at the front and rear for easy cleaning access.
- D 499HD** Extra wide frame with sleeve
Adjustable height powder coated steel frame with castors.
- E 510D** Deluxe toilet aid
Adjustable height powder coated steel frame with removable moulded seat which clips on and off for cleaning. Rubber tips.
- F 847** Folding commode chair and toilet surround
Supplied with pot for commode and sleeve for toilet surround. Lightweight aluminium adjustable height frame. Clip on toilet seat, can easily be taken off for cleaning. Clip on backrest for additional support. Folds easily for storage/transportation.
- G 501EL** Aluminium adjustable height toilet surround
Lightweight, adjustable height anodised aluminium toilet surround with moulded plastic armrests and non-marking, slip resistant rubber tips. Floor-fixed model also available - 501ELF

Transit Wheelchairs

- H TWC** Transit wheelchair - (puncture proof tyres)
Seat depth: 16". Max user weight: 114Kg. Width between arms: 18"
- I 25005** Lightweight car transit wheelchair
Lightweight car transit wheelchair with folding back, fixed arms, swing away footrests and loop cable brakes. Nylon cord seat and back upholstery, flame retardant. Fixed arms with padded arm rests. Fold down back and swing away detachable footrests, height adjustable with heel strap. Features progressive and parking braking system. Chromium plated steel. Optional elevating leg rest.
Height: 91cm
Max user weight: 110kg
- J 25017** Standard car transit wheelchair
Standard car transit wheelchair with fixed footrests. Upholstered vinyl seat and back - flame retardant. Padded and fixed arm rests with fixed footrests, height adjustable with help strap. Chromium plated steel. Features progressive and parking braking system.
Height: 91cm
Max user weight: 114kg
- K 25018** Standard car transit wheelchair
Standard car transit wheelchair with detachable arms, fold down back and swing away footrests. Vinyl upholstered seat and back with padded arm rests. Fold down back and swing away detachable footrests, height adjustable with heel strap. Features progressive and parking braking system. Chromium plated steel. Optional elevating leg rest.
Height: 91cm
Max user weight: 114kg

Self-Propelled Wheelchairs

The wheelchairs in this section have the following specifications:
Height: 91cm
Max user weight: 114kg

- A 25006** Self propelled wheelchair
Self propelled wheelchair with detachable arms, fold down back and swing away footrests. Vinyl upholstered seat and back with padded arm rests. Features progressive and parking braking system. Optional elevating leg rest.
- B 25012** Standard self propelled wheelchair
Standard self propelled wheelchair with fixed footrests. Vinyl upholstered seat and back with padded arm rests. Features progressive and parking braking system. Chromium plated steel. Optional elevating leg rest.
- 25013** Standard self propelled wheelchair
Standard self propelled wheelchair with swing away footrests. In a chrome plated steel and has a vinyl upholstered seat and back with fixed padded arm rests. Features progressive and parking braking system. Optional elevating leg rest.
- C 25014** Standard self propelled wheelchair
Standard self propelled wheelchair with detachable arms and swing away footrests. Vinyl upholstered seat and back with padded arm rests. Swing away detachable footrests, height adjustable with heel strap. Features progressive and parking braking system. Chromium plated steel. Optional elevating leg rest.
- D 25015** Standard self propelled wheelchair
Standard self propelled wheelchair with detachable arms, fold down back and swing away footrests. Vinyl upholstered seat and back with padded arm rests. Fold down back and swing away detachable footrests, height adjustable with heel strap. Features progressive and parking braking system. Chromium plated steel. Optional elevating leg rest.

Lightweight Wheelchairs

- E 25005** Lightweight car transit wheelchair
Lightweight car transit wheelchair with folding back, fixed arms, swing away footrests and loop cable brakes. Nylon cord seat and back upholstery, flame retardant. Fixed arms with padded arm rests. Fold down back and swing away detachable footrests, height adjustable with heel strap. Features progressive and parking braking system. Chromium plated steel. Optional elevating leg rest.
Height: 91cm
Max user weight: 110kg
- F 25010** Lightweight self propelled wheelchair - Blue
Lightweight self propelling wheel chair with flip up detachable arms, swing in and out footrests and fold down back. Lightweight aluminium alloy frame, 4 position rear axle adjustment, quick release anti-trippers. Front swivel castors. Has nylon cord upholstered seat, back and cushion.
Height: 89cm
Max user weight: 110kg

Wheelchair Accessories

- G AA8600** Wheelchair strap - Velcro
A strap with hook and loop fastener, which attaches to the side of the wheelchair. For waists up to 120mm (48"), width 50mm
- H AA8603** Wheelchair strap - buckle
As above but with buckle fastening for additional strength and durability. For waists up to 170mm (70").





Walking Aids

- A 102 Lightweight safety walker**
This features a lightweight aluminium frame with adjustable height handles. Padded rest seat that lifts up to reveal storage bag and cushioned safety bar to support user when resting. Folds easily for storage. Puncture proof wheels.
- B 240 Tri wheel walker**
Sturdy steel frame, adjustable in height. Easily accessible loop lockable brakes and swivel front wheel for extra manoeuvrability. 8" puncture proof polyurethane foam tyres. Easily folded for storage and transportation. Shown with optional basket.
- C 233EL Folding walking frame**
Made from lightweight anodised aluminium. Adjustable in height and easily folded for storage and transportation. Non-marking, slip resistant rubber tips for added safety. Height adjustment 78 - 90cm, width at front 55cm and the width at rear 57cm.

Please enquire for details - full range available.

Walker Trolleys

- D 109 Adjustable height walker trolley with brakes**
Cream painted steel frame with adjustable height handles. The plastic clip on trays can easily be removed for cleaning. Handle height 75.5cm - 90.5cm, overall width 58.5cm. Max user weight of 125kg/19.5st.
- E 199 Adjustable height walker trolley with wooden shelves**
Adjustable height walker trolley with a plastic coated steel frame. The trolley has angled handles for user comfort. Rails in shelf prevent items slipping off shelves. Available with 4x3" swivel castors for easy manoeuvrability. With wooden teak shelves for durability and hygiene. Height adjustment: 82 - 96cm. Maximum user weight 125kg/19.5st.
- F 199P Adjustable height walker trolley with plastic shelves**
As above but with clip on plastic shelves.

Perching Stools

- G 547A Adjustable height stool**
H 548 Adjustable height stool with arms
I 549 Adjustable height stool with arms and back
549B Adjustable height stool with arms and upholstered back
Manufactured in lightweight aluminium and suitable to be used in the shower. They feature a height adjustment to suit all user needs. Seat height adjustment 53cm - 68cm.

Overbed Tables

- 753C Overbed table with castors**
- J 751 Overbed table with split legs**
K 751C Overbed table with castors
Overbed tables are manufactured from chrome plated and powder coated steel with an angle adjustable laminated teak effect table top with edge rails. The tables are adjustable in height with split-legged base. 751C has swivel castors.
- L 872 Overbed table top with plastic top**
Overbed table with plastic top for easy cleaning. The table is adjustable in height and can easily be adjusted by lifting up the ratchet handle. Castors enable the table to be manoeuvred easily.

Overbed Tables

- A 758 Over armchair table**
This new over armchair table has a modern and ergonomically shaped laminated table top. This top is easy to clean and can be easily tilted to suit usage requirements. The table comes with a stylish side table which can be fitted to either the right or the left hand side.
- B 3012 Easi-riser overbed table**
Height adjustable from 720 - 1100mm to accommodate different heights of beds and patient positions. Anti-trapping safety feature allows the table to rise automatically if it comes into contact with the patient. Attractive fire retardant oak laminated finish with raised upstand for durability and hygiene.
- C 3013 Easi-riser overbed table**
As above but with a curved base which allows the table to be positioned around an armchair or wheelchair.
- D 3014 Easi-riser overbed table**
All the features and benefits of the 3012 model with the addition of a tilting top for flexibility. The tilting top adjusts from 0-60° to accommodate different patient positions.
- 3015 Easi-riser overbed table**
As above but with a curved base which allows the table to be positioned around an armchair or wheelchair.

Bed Accessories

- E 615 Deluxe backrest**
Deluxe backrest, manufactured from chrome plated steel, complete with vinyl upholstery. Can be adjusted to four positions to suit various users and can be folded flat for easy storage.
- F 636 Powder coated backrest**
Powder coated steel backrest, complete with nylon back upholstery. Can be adjusted to five positions to suit various users and can be folded flat for easy storage.
- G 613 Folding bed cradle**
Folding bed cradle manufactured from chrome plated steel. The cradle fits under the mattress, supports weight of bedclothes and reduces contact between bedclothes and injury. Folds flat for when not in use.
- H 780 Bed stick with double loop**
Manufactured from powder coated steel and zinc plated chrome, with a double loop to assist users in and out of the bed. It fits securely under the mattress, is adjustable in width and fits single and double beds.
- I 804 Rise Easi single bed aid**
805 Rise Easi double bed aid
The Rise Easi bed aid can be used to assist turning and sitting up in the bed. When in a sitting position, the Rise Easi is rotated to any angle, and can be used on the left or right side of the bed. Swing out support arm does not interfere with bed clothes.
- J 806 2-in-1 bed rail**
This is the only bed support for both divan and slatted beds. Unclips for easy storage and transportation. Plastic base gives durability. Easy to clean.
- K 859 Bed rope ladder**
A simple idea to assist with sitting up in bed. Tie ends of cord around the bed legs, use ladder to pull up to a sitting position. Suitable for use in single or double bed.





Bed Accessories

- A 799 Patient helper - floor standing**
Manufactured from box section powder coated steel with freestanding base and gantry. Adjustable height strap with trapeze, and moulded plastic handgrip. Disassembles into 3 pieces for easy storage and transport.
- B 17 Deluxe drip stand**
Adjustable in height, with a low centre of gravity and manoeuvrable castors.
- C SCR01/White Ward screen (frame only) - Epoxy**
This is a four panelled screen which can be folded completely flat for storage. Swivel castors for ease of manoeuvrability. Epoxy coating for durability and hygiene. Dimensions 1680mm (H) x 2440mm (W) max.
- D SCR03/ChromeWard screen (frame only) - Chrome**
As above with a chrome frame.
- E SCR/21/22/23 Plastic PVC screen curtains**
Choice of green, white or blue. Fire retardant.
- F SCR24/25/26 Polyester screen curtains**
Choice of beige, blue or green.
- Y188 Privacy screen - 4 fold**

Bed Rail Bumpers

- G SBRB Standard bed rail bumper 135 x 36cm**
LBRB Long bed rail bumper 198 x 36cm
HBRB High bed rail bumper 135 x 43cm
LHBRB Long and high bed rail bumper 198 x 43cm
Foam filled, and covered in two-way stretch, vapour-permeable fabric, these bumpers offer patient protection at a cost-effective price.
- H HCS090 Side rail wedge set (1pr)**
The side rail wedges provide a robust and versatile solution to patient protection. The 890mm wedges are deployed two per side, zipped together, or to head, foot and sides, to suit specific needs.
- I HCS112 2 bar bumper for profile bed (set)**
The 2 bar bumper is a snug fitting zip on bumper designed to fit over wooden side rails with netting insert to improve visibility.

- 15201 Profile bed bumpers, net insert with velcro (pair)**

Bed Rails

- J SDBR Standard Divan bed rails**
SHBR Standard Hospital bed rails
HDBR High Divan bed rails
HHBR High Hospital bed rails
All bed rails are chromium plated and are adjustable in length from 1220 - 1780mm. When used with dynamic systems and any type of mattress overlay, the high bed rails are recommended, to provide the required level of patient safety.
- K HCS095 Safety wedge set**
The safety wedge set provides a safe, firm, sloping barrier to keep the patient comfortably positioned.

Crash Mats

- HFC102 Crash mat - 1830x610x100mm**
Standard density foam with vapour-permeable cover.
- A HFC103 Crash mat - 1420x810x64mm**
B 21001 Folding crash mat - 1800x600x64mm
High density foam with vapour-permeable cover.

Beds

- C 19849 Classic FS profiling bed**
Profiling bed with mesh sleeping platform and integral side rails. 4-section mattress support, 2-motor adjustment, separable for transport. Emergency lowering by quick-action bolt mechanism. Adjustment angle of back section 0° - 70° and foot section 0° - 20°. **Max user weight: 140kg**
Height range: 40cm to 80cm
- D 17012 Askern profiling bed**
This bed has an attractive beech effect and combines all the usual comfort functions and safety criteria, without compromising on quality. With mesh sleeping platform and integral side rails. The Askern is a 4 section profiling bed with a wooden slat base, 2 motor adjustment separable for transport. Also has adjustable head and foot sections along with a dual action headrest and knee break adjustment. This bed is uniquely designed for the comfort and safety of the carer and client. **Max user weight: 140kg**
Height range: 40cm to 80cm
- E 17013 Elsted profiling bed**
The Elsted has a mesh base and is a 4 section profiling bed with 2 motor adjustment, separable for transport. Also has ergonomic adjustment of head and foot sections along with additional positioning of foot section. This bed is uniquely designed for comfort and safety of both the client and the carer. **Max user weight: 140kg**
Height range: 40cm to 80cm
- F 10156 Classic low profiling bed**
This product combines the highest level of functionality, safety and comfort. With mesh sleeping platform. 4-section mattress support, 2-motor adjustment, separable for transport. Handset includes locking facility to maintain position. Emergency lowering by quick action bolt mechanism. **Max user weight: 140kg**
Height range: 23cm to 63cm

Accessories for above

- 17001 Bed extension kit - 220cm**
To work with 17012/17013/19849





Beds

- A 17016** Etude Medley profiling bed - exposed actuator
- B 17017** Etude Medley profiling bed - closed actuator

The Etude Medley Select provides ideal position for the carer and total comfort for the client. It is a 4 sectioned profiling bed with improved functionality and efficiency. In a beech finish, these beds are designed for easy transport and assemble.
Max user weight: 180kg
Height range: 40cm to 80cm

- C 17014** Etude Medley low profiling bed - without side rails
- 17024** Etude Medley low profiling bed - with side rails

The Etude Medley low bed makes it easier for clients to get in and out of bed, providing more independence. This offers increased security for clients enabling them to sleep with real peace of mind. Available with or without side rails. Easy to assemble and dismantle and can be transported easily.
Max user weight: 180kg
Height range: 22cm to 62cm and 29 to 69cm

- 17029** Medley select bed ends
- 17020** Solite Laser community bed - 2 sectioned
- D 17221** Solite Laser community bed - 4 sectioned
- E 17022** Solite Laser community bed - vari-height

The Solite Laser range of profiling beds are electrically operated profiling beds with variable height control to provide ease of operation for both carer and user. Designed for quick and simple yet safe assembly. Have braked castors. The Solite Laser profiling beds are available in a 2 sectioned profiling, 4 sectioned profiling and in a variable height option.
Max user weight: 180kg

- F 17019** Bradshaw bariatric low profiling bed

Robust and sturdy bariatric profiling bed, quick and easy to assemble. Electrically operated rising backrest and kneebrake functions. Attractive domestic appearance with high quality wooden head and foot ends and full length integral wooden side rails.
Max user weight: 320kg
Height range: 25.9cm to 62.5cm

- G 17023** Boston home care bed

Designed for the residential and nursing care home markets with removable light oak head and foot boards. There is an under bed clearance of 15cm enabling a wide range of hoists to be used in conjunction with the bed.
Max user weight: 180kg

Divan Beds & Mattresses

- WDBS** PVC Divan bed base - single
- WDBD** PVC Divan bed base - double

All upholstered bases are available in 75, 90, 120 and 135cm widths and have a stitchbond cover with PVC (water resistant) coating. 20cm/8" platform top base 6 x 18cm/7" fixed legs - 4 with domes of silicone and 2 with castors.

- WDMS** PVC Divan mattress - single
- WDMD** PVC Divan mattress - double

These mattresses are in a stitchbond cover with two layers of upholstery, feature PVC (water resistant) coating and are available in 75, 90, 120, and 135cm widths.

- H WDSS** PVC Divan set - single
- WDSB** PVC Divan set - double

Comprising bed base and mattress as above.

Divan Beds & Mattresses

- A WPHS** Waterproof Hi-Performance mattress - single
- WPHD** Waterproof Hi-Performance mattress-double

Tear and pull resistant, these covers are hypo-allergenic, antibacterial, waterproof and vapour permeable.

- WDM4** Waterproof Hi-Performance divan mattress
- WDB4** Waterproof Hi-Performance divan base

4' single tear and pull resistant mattress, these covers are hypo-allergenic, antibacterial, waterproof and vapour permeable.

- B V15** Velour headboard - single

A 15" high velour upholstered head board with buttoning, available in a large range of colours: midnight blue, champagne, green, honey, ivory, lilac, peach and sliver blue.

- C SH3** Solid headboard - single
- SH4** Solid headboard - 4'
- SH46** Solid Headboard - 4'6"

Available in: beech, limed oak, maple and mahogany

Chair & Bed Raisers

- D 864** Multi purpose raisers pack

The multi purpose raisers pack has been designed to be discreet when used under furniture, with the least intrusion and maximum support giving security and reassurance. Set consists of: Four plastic cups c/w beams, one spreader bar and eight rising clips. Maximum user weight 500kg/78st.

- E 716** Leg X chair raisers

Adapt a conventional chair rather than buy an expensive purpose designed one. Raises the chair 3-5" using blocks. Uniquely Leg-X has flexible internal fins which grip the chair leg without damaging it, allowing the furniture to be easily moved.

- F 794** Elephants feet 9cm (3.5")
- 794A** Elephants feet 14cm (5.5")

Simply place under chairs or beds to raise the height. A simple, strong, one-piece grey plastic unit which blends with any furniture. A central recess allows castors to safely locate for stability. Available in two sizes.

- G 717** Langham linked chair raisers
- H 720** Langham linked bed raisers

Bed width 91.4cm to 146cm

- 720A** Langham linked bed raisers

Bed width 61cm to 89cm. Designed for raising beds with legs. With built in height adjustment using insert blocks supplied with the raising unit, there are three heights to choose from. Maximum user weight 500kg/78st.

Medical Trolleys

- I 1500/A/3** Surgical trolley 76 x 46cm
- J 1501/A/3** Surgical trolley 61 x 46cm
- 1502/A/3** Surgical trolley 76.5 x 46cm

These trolleys have rounded and cut-away shelf corners for safety and ease of cleaning. Shelves can be reversed providing a flush working surface. Epoxy coated white steel frame with aluminium shelves and anti-static swivelling castors. Also available with stainless steel shelves or stainless steel frame and shelves.

- 1308/WHITE** Steel drawer unit for surgical trolleys

Ideal for storage of equipment and instruments.

- BUFFER/006** Protective buffers for surgical trolleys

Set of four, to prevent damage to trolley or surroundings.

- K 1530/1** Cylinder trolley - size AF

Suitable for (AF) size cylinders (66cm x 18cm).

- L 1527** Cylinder trolley - size F

As above, for (F) size cylinders (94cm x 12.5cm)

- M 1531** Cylinder trolley - universal

Suitable for all size cylinders up to G. For cylinder dia 9cm - 20cm.





A Drug Trolleys & Storage

Complete range of drug trolleys and storage units available including all Bristol Maid products. Please enquire for details and pricing.

Laundry Trolleys

- B 1523/2 Single linen trolley**
Basic trolley for linen collection and distribution, with 50mm castors. Optional linen bags
- C 1521/2 Double linen trolley**
As above with the additional linen bag ring.
- D 1599 Chepstow changing trolley**
Dual purpose trolley with three removable shelves and 100mm castors, supplied with 1 white linen bag. 104cm x 51cm x 113cm.
- E LC/2000/1 1 bag stainless steel laundry cart**
- LC/2000/2 2 bag stainless steel laundry cart**
- F LC/2000/3 3 bag stainless steel laundry cart**
- LC/2000/4 4 bag stainless steel laundry cart**
A robust range of stainless steel trolleys, lightweight, stable and easy to use. Colour coded and with wheel brakes for added convenience.
- G Kcart/Combi KarriCart Combi with 12 trays**
- H Kcart/2 KarriCart Twin with 16 trays**
- Kcart/3 KarriCart Triple with 24 trays**
- Kcart/4 KarriCart Quad with 28 trays**
Designed to ensure quick, efficient and clean distribution of residents/patients personal clothing. Fluid proof, colour coded, lightweight and compact, with sturdy hanging rail.

Drugs Fridges

- I 15701-36L Pharmacy fridge**
This fridge keeps temperature sensitive medicines between 2°C and -8°C. Complete with digital thermometer. Dimensions 580mm x 422mm x 393mm. Power input 65w.
- J 15702-66L Pharmacy fridge**
As above, but dimensions 592mm x 486mm x 494mm. Power input 85w.

K Record Books

- ABG Accident book - Guildhall**
- AB Accident book**
For recording all accident details.
- ARB Accident report book**
Issued by The Stationery Office. Data Protection Act compliant.
- ABK Admission book - 2 entries per page**
Essential record of admission and discharge of residents. 100 pages and index.
- CDB Controlled drugs book**
To record the administration of controlled drugs in the Home. 100 pages with index.
- DRB Daily report book**
- REMND Notification of deaths book**
- RMD Record of medication destroyed book**
To record the medications removed from, or destroyed at the home. 100 pages.



A Record Books

- SRB Staff register book**
To record the details of all staff employed at the home. One page per staff member.
- TLB Temperature log book**
To record the temperature of fridges, freezers and probe thermometers on a regular basis.
- VB Visitors book**
Wire bound A4 in landscape format to provide date, name, who visiting, number of visitors, time in and time out. To assist in general security and vital in the event of fire.

Thermometers

- B TH809 Tympanic ear thermometer**
Compact in size which makes this thermometer ideal for travelling. One second measurement with large LCD display for easy reading. Fever alarm. Conforms to ASTM accuracy standards.
- C BTE Braun Thermoscan ear thermometer**
Measures temperature by measuring the heat generated by the ear drum. 8 memory functions with lithium batteries supplied. Flexible thermometer tip for added gentleness. Temp range: 34°C to 42.2°C. Ambient range: 10°C to 40°C.
- D TH809C Ear thermometer probe covers**
- E OGT Omron gentle temp ear thermometer**
Infrared ear thermometer giving safe, fast and accurate readings. Simple to use, memory button recalls the last 9 readings taken. Set includes batteries and 20 protective tip covers. 12 month warranty.
- F OIT5P Omron ear thermometer probe covers**
- G 839-095 Ear thermometer batteries**
- H TH80F Digital forehead thermometer**
Using advanced infrared and ambient temperature compensation for fast accurate measurements. Very small and compact this unit is ideal for surgery, domiciliary and domestic use. Reduces the risk of cross contamination and the need to use disposable covers.
- I FST Forehead strip thermometer**
This is a forehead thermometer which is fast and reliable as well as being safe and non-invasive. The temperature is read via colour boxes in less than 15 seconds.
- J D5488 Zeal Tempa-Dot disposable thermometer**
This is a hygienic single use clinical thermometer. No risk of cross contamination, simple to use and individually sterile packed.
- K DCT Digital clinical thermometer**
- L FBT Floating bath thermometer**
Ideal for constant monitoring of the water temperature for bathing of the elderly, infirm or minor patients. Measurement range 0 to 50°C
- M SBT Scoop bath thermometer**
A safe and simple means to measure the temperature of liquids. Measurement range -5 to +50°C.
- N WDT Waterproof digital probe thermometer**
A water resistant digital thermometer with probe.
- O CDT Compact digital thermometer**
With a fixed probe, Deg F & C, max/min and hold temperature functions. Measurement range -40 to + 200°C.
- P DTP Digital thermometer**
With probe
- DTP/C Digital thermometer**
With probe and calibration certificate
- Q RT Room thermometer**
A simple wall-mounted spirit thermometer. Range -20 to +50°C.





Thermometers

- A DRT Digital room thermometer**
Compact wall mounted for discreet monitoring of rooms, cupboards and larders. Measurement range -50 to +70°C.
- B FFT Dial fridge freezer thermometer**
Stainless steel cased constant temperature monitored display. Measurement range -30 to +30°C.
- C WM100 Max/Min thermometer**
These thermometers record the highest and lowest temperatures reached until resetting.
- D DFFT Digital fridge freezer thermometer**
Constant temperature reading using an internal probe, with the display unit positioned outside the fridge.
- E DOT Dial oven thermometer**
A sturdy dial thermometer which can be hung from a shelf or stand to ensure your oven is reaching the correct cooking temperature.
- F DTM Dial meat thermometer**
A stainless steel dial thermometer to ensure the meat is correctly cooked. Also essential when cooking meat from frozen.

Nebulisers

- G W6540 Drop nebuliser**
Efficient and practical, with a choice of two nebulisation speeds. Min pressure 26.8psi (1.85 bar). Operating pressure 11.6psi (0.8 bar). Nebulisation rate, with plug open 0.36ml/pm and with plug closed 0.18 ml/pm. Chamber capacity 8ml. The kit contains a carry bag, child and adult mask, mouthpiece, nose piece, chamber, filter and tubing.
- H 120.22.00 Travelneb plus portable nebuliser**
This is a great value product ideal for clinic and home use. Clear displays and water level indicators with an automatic power down function. Mixes medicines evenly and thoroughly, with electronically adjustable nebulisation speeds. The kit includes a nylon carry bag, platform/base unit, mouthpiece, adult and child mask, extensible tube (12 -30cm), rechargeable battery pack, mains adapter with UK 3 pin plug, 2 replacement filters and 10 medicine cups.
- H2N Happy Neb II Nebuliser**
Mains operated, 15lt/min. flow rate, 60ml/min. nebulisation rate. Weight 2.3kg.

Suction Machines

- I W4606 Tornado mini aspirator**
Mains operated mini suction pump ideal for tracheotomy evacuation. Twin bottle design protects pump from fluid ingress. 250cc bottles. Maintenance free. 65/72 kPa total vacuum. Size: 22 x 19 x 12cm, weight: 2.5kg.
- J 3ASM 3A Aspeed suction machine**
Robust piston type aspirator with a compact design requiring no maintenance. High performance and durability, ideal for general practice, nursing homes and occupational health. Effective vacuum level 0 - 0.85 bar, available in single and double pump versions. Dimensions 18.5 x 33 x 21cm, Weight 3.5kg. 500cc bottle with motor protector cap and silicone connection tube, connecting cable, tube and valve for manual adjustment included. 12 month guarantee (excluding accessories).
- K 3ASMSM 3A mini rechargeable suction machine**
This is a professional aspirator with rechargeable battery for out-patient and home use with rotary piston compressor. Specifically for post-tracheotomy patients who need numerous daily applications. Quiet, practical and simple to use.

Suction Machines

- A OB2012 Emergency aspirator 12V/Mains rechargeable**
Medical suction unit, with a silent, powerful double piston motor. Available with 1000ml jar and disposable liner or 1000ml autoclave jar. Air flow: >30lt/min. Adjustable suction with analogue dual gauge 0 to >800 mbar/80kPa. Autonomy 45 minutes. Double safety fuse with an ABS shock resistant case. Allows direct operation from 12vDC vehicle source and charging of the battery from any 12V source. Supplied complete with 12V charger (mains charger optional). CE 0434 certified.
- W95021 Portable emergency aspirator**
Modern and compact with a silent powerful double piston motor. Includes 1000ml jar with disposable liner, integrated protection filter and shut-off valve plus a 1000ml autoclavable jar with protection filter and shut off valve. Adjustable suction gauge. 45 minute autonomy with double safety fuse and ABS case shock resistant. Dimension 350 x 120 x 245mm, weight 4.9kg. 3 year warranty. CE 0434 certified.

Manual Aspirators

- B W4442 Emergency manual resuscitator**
This adult manual resuscitator in high quality material that allows true re-inflation of bags over a wide range of temperatures. Air intake valve has fully integrated O2 reservoir valve. Fully collapsible for easy storage. 360° rotational patient valve for easy repositioning of bag and mask. Complete with O2 driveline and reservoir. CE approved.
- C W46081 Res-Q-Vac manual aspirator**
Reusable aspirator manually powered by hand. Simple to use, designed for use by first responders. Disposable single use collection canister. Comes complete with ridged adult yankeur and adaptor.

Sphygmomanometers and Blood Pressure Machines

- D W3258 Practicus aneroid sphygmomanometers**
A hand operated aneroid unit with analogue display, latex free bulb, corrosion-free precision manometer and a well designed scale (marked in mmHg). Supplied in tough, environmentally friendly plastic - chrome plated.
- E ANS Aneroid sphygmomanometers**
This features a handy spring loaded catch mounted on the rear of the chamber, allowing the unit to be attached directly to the cuff or any other convenient position, 48mm dial ensures easy reading of pressure valves. Supplied with adult Velcro cuff and storage case.
- F M.000.09323 Heine aneroid wall mount sphygmomanometers**
Large 125mm scale for easy viewing. Wall mounted with storage space for cuff and inflation system ideal for treatment rooms. Maintenance free, with copper and beryllium manometer, precise and long-lasting. Spiral tubing allows long working distance and swivel head gives good view from any angle. This is an ideal replacement for mercury BP monitors, completely latex free. 10 Year guarantee.



Sphygmomanometers and Blood Pressure Machines

A W32540 Digital BP monitor

Stethoscopes

B DHS Dual head stethoscope
These stethoscopes are lightweight, economical and available in 12 different colours.

Ophthalmoscopes

C 70022 Piccolight ophthalmoscope
This ophthalmoscope features a correction wheel +/- 20 diopters with large circle aperture. Requires 2 x AA batteries (not included). Available in black, blue and green.

Syringe Drivers

0105-0504 MS16A hourly Graseby syringe driver
A portable syringe driver with period range 30mins - 60Hours. Speed range: Variable 0 - 99mm/hr

D 0113-0001 MS26 24 Hourly Graseby syringe driver
A portable syringe driver with a period range: 12 Hours - 60 Days. Speed range: Variable 0 - 99mm/day.

E T34 T34 Ambulatory Syringe Pump
Automatic calculation of syringe volume and depending on mode of operation, can deliver contents over a specified duration or as ml/hour. Lockable ml/hour setting (rate setting) suitable for homecare use. The Post Occlusion Bolus Reduction System will safely equalise pressure in the line, following an occlusion, without administering a potential post-occlusion bolus. Configurable occlusion pressures for different clinical applications and therapies. Four configurable modes of operation available to suit specific applications:
Lock on
Lock off
Rate mode
Rate setting

Miscellaneous

F PF00 Piccolight otoscope
High quality fibre optics gives white, circular and intense light. Swivel magnifying lens.

G W4350 M-Pulse finger oximeter
The M-Pulse oximeter is the perfect choice for on-the-spot spO2 and pulse rate testing. This unit is lightweight and small in size featuring a low energy, long life OLED display, 10 brightness levels, 6 display modes and adjustable illumination. Requires 2 AAA batteries (supplied). SpO2 range: 0 to 99%. SpO2 resolution: ± 2% (80% to 99%) or ± 3% (70% to 80%). Pulse range: 0 to 254 bpm. Pulse accuracy: ± 2 bpm or 2%.

Miscellaneous

A W6267 Propulse ear syringe kit
W72720 Propulse NG Ear Irrigator & Starter Pack
Everything you need to get started. Includes 1 x Ear Irrigator, 1 x Carry case, 1 x 100 QrX Tips, 1 x 200 Disinfection tablets, 1 x Propulse head lamp, 1 x Mushroom valve & washer pack, 1 x Noots tank, 1 x Shoulder cape and 1 x Wax removal scoop. Designed to save you money as well as time.

Combines new QrX tips with quick release system for easier removal. Ideal irrigator for use within surgery or on domiciliary visits. Dual power with mains and rechargeable battery operation. Complete portability and is supplied with user manual, power adapter, footswitch and 10 disposable QrX tips.

B W138 Noots ear tank (100)
For use with W6267 Irrigator. Stainless steel.
C W6204 Ear syringe cape
D D6268 Propulse cleaning tablets (200)

Nurse Call Floor Mats

E FSM2P 2 pin mono nurse call mat (see G)
FSM3P 3 pin stereo nurse call mat (see H)
These call mats work via your existing nurse call system. Saves staff time by reducing the time consuming "room checks". There are no false alarms, only activated when stepped on therefore increasing patient safety. Generous in size and made from high quality double-sided non-slip grey rubber. Supplied ready for use. They still allow use of personal push button buzzer lead. Available in 2 pin mono and in 3 pin stereo.

Nurse Call Stand Alone Systems

A versatile portable battery powered alarm, designed for sounding the alarm when the patients weight moves off the bed, chair or toilet seat sensor pad.

95730 Sentry delux monitor with one year bed package
F 96250 Sentry delux monitor with one year floor package
G 95730-chair Sentry delux monitor with one year chair package

Accessories for Sentry monitors

H NCMONO Nurse call cable mono
I NCPLUGSTEREO Converts mono cable to stereo
J NCSPECIAL Nurse call cable special



Furniture

- Bedroom and Lounge Chairs
- Dining and Occasional Furniture
- Sofas
- Tub Chairs
- Dining Furniture
- Specialist Seating
- Bedroom Furniture



“ Offering you the complete furnishing solution, furniture designed and manufactured in the UK to suit your needs and meet your requirements. ”



Andway Healthcare provide armchairs, lounge chairs, tub chairs and dining chairs as well as bedroom and dining furniture suitable for care, nursing and dementia homes.

Our upholstered furniture is built to a contract standard with most items with our range having a 5 year frame warranty. All our upholstery is health care specific and designed to be used in a contract setting. There is a wide variety of fabrics to choose from, and you can also choose from a 'soft to the touch' fabric, or a more durable vinyl. Consideration should be given to your environment, and type of service user.

Corresponding accessories and soft furnishings can be supplied to match or compliment the upholstered furniture of your choice. We have an extensive range of fabrics so, please do not hesitate to contact us to discuss your specific requirements, to get a quote or to request a colour/fabric sample.

Bedroom and Lounge Chairs

A wide variety of bedroom and lounge chairs are available to suit every nursing home requirement whether you are looking for quality, value for money or the contemporary look. Our lounge furniture is designed to be comfortable for clients in care home and nursing home environments, giving care providers peace of mind that a high standard of care is being maintained at all times. We have provided some examples of our lounge furniture to give you an idea of the different styles and types available.

Our chairs are designed for more specific needs to the care sector, our range offers a wider selection of products with enhanced levels of style and comfort.

All frames and spring suspensions come with a 5 year guarantee.

Sofas

Our Sofas are designed specifically to meet the needs of nursing and residential care homes where practicality, durability and value for money are foremost.

Tub Chairs

Ideal for use in lounges, reception areas and recreational rooms - providing excellent comfort in a range of settings.

Dining and Occasional Furniture

Offering a complete dining room furniture solution for use within the commercial health care sector. Our durable dining furniture has been built to withstand the demands of today's care homes, nursing homes and dementia homes. Furthermore, we are confident that our more specialist dining furniture fulfils the requirements of other end users such as hospitals, sheltered housing and challenging behavior settings. We provide dining room furniture that is strong, sturdy, reliable, as well as built to an individuals' specific requirement.

Our dining room furniture is available with a number of features including dining chairs complete with skis or skids. We also have a huge choice of waterproof fabrics, vinyl's, lacquered, anti-microbial and anti-fungal fabrics. Heat resistant and scratch proof table tops are available in various wood colours alternatively we provide a colour matching service. All products are flame retardant to the commercial health care standard, crib source 5.

Our standard range of dining furniture is available in a variety of sizes with your choice of round, square or rectangle table top, as well as a choice of leg style. We also provide adjustable tables or tables that allow wheelchair access. However, if you are after a totally bespoke dining room furniture solution, please contact our sales office for further details.

Specialist Seating

A full range of specialist seating is available for all ages and degrees of physical need. Chairs designed to combine function with comfort, all day support and reduces manual handling demands as well as being lightweight, compact and having a contemporary design.

Bedroom Furniture

Our care home bedroom furniture has been designed and chosen specifically with the care home environment in mind.

Our carefully selected range of products means users and care providers benefit from features which many alternatives fail to provide - a subsequent bonus for you the purchaser. Andway Healthcare has whatever you are looking for from budget bedroom furniture packages to bespoke, fully fitted bedroom furniture.

Some of the features of our standard furniture for care home ranges include safe rounded corners - which is particularly beneficial within the nursing/dementia environment or where there are people prone to falling down. Furthermore, most of our furniture for care home bedroom ranges are supplied on castors for ease of cleaning or relocating to other bedrooms etc.

In addition, some of our care home bedroom furniture range features extra large handles - most helpful to users with chronic arthritis or the partially sighted. And, there are some care home furniture bedroom ranges that use 170 / 180 degree hinges which enables the user to fully open wardrobe doors - a particular advantage for wheelchair users or for use within tight spaces.

Soft Furnishings

Corresponding accessories and soft furnishings - such as curtains - can be supplied to match or compliment the furniture of your choice. We have an extensive range of fabrics so, please do not hesitate to contact us to discuss your specific requirements, to get a quote or to request a colour/fabric sample.

For further product information, request a price or to find out availability of our furniture ranges please call our sales office on: 01423 331000 or visit our website at www.andwayhealthcare.com/Products/Furniture.

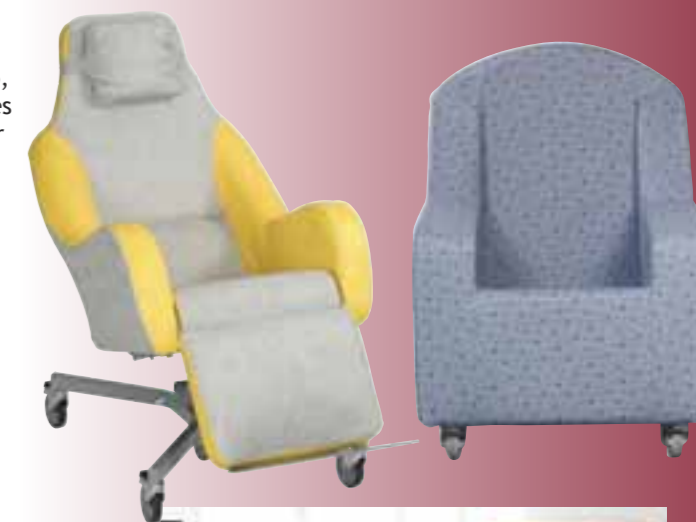

Interiors

Interior design and space planning

Colour co-ordination and styling

Quality contract furniture and equipment

Soft furnishings and finishing touches

Total project management



“ At Andway Healthcare Interiors we aim to assist ‘Care Homes in caring’ - by working with your projects team to ensure that appropriate products, designs and fabrics are selected from our extensive ranges to ensure you create the desired environment for your clients.

We will help ensure the smooth running of your project by providing effective products, on-time solutions and professional friendly advice. ”



Andway Interiors; work with your projects team to ensure that appropriate products, designs and fabrics are selected from our extensive ranges to ensure you create the desired environment for your clients.

We are specialists in Healthcare Environment; we undertake to provide a consistent quality of well-managed and professionally completed refurbishment and fit-out work in Healthcare Environments to a high standard with quality assured checks to all finishes.

Why use Andway Healthcare Interiors?

- We offer you a completely hassle-free solution to your fit out project.
- Most of all we understand healthcare thereby ensuring that we will only supply products suitable for specific environments.
- Our experienced design team work closely with our clients maximizing available space and assuring a comfortable yet practical interior.

Andway Healthcare Interiors is ideally suited to fulfill your Nursing Homes requirements whether it is fit-outs/reburbishments in...

- Bedroom, lounge and dining
- Housekeeping, kitchen and laundry
- Treatment, drug storage and nursing supplies
- Moving and Handling, care beds and mobility
- Staff rest rooms and lockers
- Paper and soap dispensing systems
- Laundry and kitchen dosage systems

We Offer:

- Interior design and space planning
- Colour co ordination and styling
- Quality contract furniture and equipment
- Soft furnishings and finishing touches
- Total Project Management
- National coverage on project management and installation

Use our experience and expertise in nursing, dementia, mental health & residential care to ensure that your concept is taken to completion!

Project Planning

Andway Healthcare will undertake every stage of the project with you. We will find a solution that is not only workable but aesthetically pleasing, stylish, practical and within budget.

On-time and On-budget...

Our comprehensive installation service ensures you achieve an on-time and on-budget project.

No matter how small your budget we have the products and expertise to meet your needs

Let Andway Healthcare turn your aspirations into reality!



From concept...

...To completion

A

Adhesive tape	20
Adult clothes protectors	64
Air fresheners	25
Alcohol gel	9
Alternating cushion systems	45
Alternating mattresses	43
Alternating overlay systems	43
Apron dispenser	36
Aprons	7
Armchairs	94
Aspirators	13
Aspirators	89
Attend chairs	94

B

Baby bath	39
Backrest	81
Baking parchment	31
Bandages	20
Bariatric beds	84
Bath	70
Bath boards	70
Bath hoists	55
Bath mats	70
Bath seats	70
Bath sheet	67
Bath towel	67
Beakers feeder	16
Bed aids	81
Bed bath	39
Bed pads	14
Bed pads	63
Bed pans	15
Bed pull	81
Bed rail bumpers	82
Bed rails	82
Bed raisers	85
Bed rope ladder	82
Bed stick	82
Bedding - 2 way stretch	67
Bedding - polycotton	66
Bedding - polyester	66
Bedding protection	65
Bedroom furniture	95
Beds profiling	83
Beds bariatric	84
Bibs disposable	36
Bic disposable razors	40
Bidet bowl	77
Bin liners	10
Bleach	26
Blood pressure machines	89
Body wash	39
Books - record	87
Bowls	12

Burn relief	21
Burns kit	19

C

Carpet cleaners	26
Carpet cleaners	30
Carpet shampoo	26
Catering consumables	31
Catheter bags	15
Catheters - suction	13
Caustic soda	28
Centrefeed roll	35
Centrefeed roll dispenser	36
Centrimide cream	22
Chair raisers	85
Chair pads	63
Chair trolley	60
Chairs	94
Chairs dining	94
Chairs recliner	95
Chairs shower	76
Chairs tub	94
Channel blocks	28
Chloride plus tablets	26
Cling film	31
Clothes protectors	64
Cloths all-purpose	29
Cloths microfibre	29
Cloths oven	29
Cloths standard	29
Coffee tables	94
Commode buckets	15
Commode chair	73
Commodes	73
Conditioner	39
Cotton buds	39
Cotton wool balls	22
Cotton wool balls	11
Cotton wool rolls	11
CPR masks	12
Crash mats	83
Cream cleaner	26
Crockery	32
Cutlery	32
Cylinder trolleys	85

D

D10 bac-concentrate	26
D2 multi-concentrate	26
Decibitus postioning cushion	49
De-greaser	26
Denture pots	12
Deodorant	40
Descaling liquid	26
Dettol	26
Dining furniture	94
Dish cloth	29

Dishwasher liquid	25
Dishwasher powder	25
Dishwasher salt	25
Disinfectant	26
Disposable bibs	36
Divan beds	84
Dressing adhesive	20
Dressing sterile	21
Dressing packs	10
Drip stand	82
Drug trolleys	86
Drugs fridges	86
Duster	29
Dustpan and brush sets	30
Duvets	64

E

Ear syringe kit	91
Elbow pads	49
Elephants feet	85
Evacuation mattress overlay	59
Evacuation sheet	59
Eye bath	20
Eye pads	20
Eye wash solution	20
Eye wash station	79

F

Fabric fresheners	25
Fabric softener	27
Face cloth	67
Facial tissue	35
Feeder beakers	16
Finger nail clippers	39
First aid kits	19
Floor cleaners	26
Floor pads	63
Fly killer	25
Foam bath	39
Foam mattresses	46
Foil	31
Forceps	11
Forceps	22
Fridges - drugs	86
Furniture bedroom	94
Furniture dining	94
Furniture polish	25

G

Gauze swabs	21
Glass cleaners	26
Glasswash	25
Glove dispensers	36
Gloves disposable	7
Gloves rubber	30
Grab rails	71

H

Hair brush	39
Hair care	39
Hair wash basin	70
Hairnets	8
Hairspray	39
Hand towel	67
Hand towel dispenser	36
Hand towels disposable	35
Handling belts	58
Hard surface cleaners	26
Headboards	85
Heel pads	49
Hoists	52
Hygiene/couch roll	35

I

ID band	16
Incontinence bed pads	63
Incontinence products	14
Instrument trays	12

J

Jeyes fluid	26
Jugs	16

K

Kidney dish	12
Kitchen towel	35

L

Lancets	12
Laundry de-stain liquid	27
Laundry de-stain powder	27
Laundry detergent	27
Laundry liquid	27
Laundry powder	27
Laundry trolleys	86
Leg raiser	60
Legrests	35
Limb support	60

M

Masks	13
Mats bath	70
Mats nurse call	91
Mattress replacement modular foam	46
Mattress replacements	44
Mattresses	84
Medical probe	22
Medical trolleys	85
Medicine measures	12
Medicine spoon	16
Metal cleaner	28
Mobcaps	8

M (Cont)		S	
Mobile shower chairs	77	Sacks	10
Mops	29	Salt - dishwasher	25
Mop bucket	29	Sample bottles	12
Mop wall tidy	29	Scales patient	72
Moulded mattresses	34	Scales wheelchair	73
Mouthwash	40	Scalpels	22
N		Scissors	22
Napkins	31	Scourers	29
Nebulisers	70	Sensor pads	91
Needles	11	Shampoo	39
Net pants	15	Shampoo - carpet	26
Nurse call systems	73	Sharps bins	22
O		Shave foam	40
Occasional furniture	86	Shower chairs	76
Odour killers	28	Shower cleaner	26
Odour neutraliser	28	Shower gel	39
Ophthalmoscopes	72	Shower seats	77
Ottoscope	72	Sign - wet floor	36
Oven cleaner	28	Slide sheets	57
Oven gloves	29	Slings	55
Overbed tables	62	Sluice detergent	28
Overlay mattresses	34	Soap bath	28
Overshoes	7	Soap cleansing	27
Oversleeves	7	Soap foam	27
Oximeter	72	Soap hand	28
P		Soap cartridges	27
Paper rolls	35	Soap dispensers	27
Pen torches	20	Sofas	94
Petroleum jelly	9	Spatulas	16
Pill crusher	16	Sphygmomanometers	89
Pillows	49	Sponge	70
Plasters	20	Spoon - medicine	12
Plastic nail brush	39	Spoon - medicine	16
Polish cleaners	28	Spray and wipe sanitizer	26
Polyfoam	9	Spray bottle - trigger	30
Positioning cushions	49	Sputum pots	12
Procedure packs	10	Stacking cup	24
Pull up pants	14	Stain remover	27
Pump dispenser	36	Stainless steel cleaner	28
R		Stand assist hoists	52
Rails	71	Stand-up slings	55
Recliner chairs	94	Static cushion systems	48
Record books	86	Static mattresses and overlays	45
Resuscitators	89	Steradent tablets	40
Resuscitators	13	Stethoscopes	90
Rota cushions	60	Stitch cutters	22
Rota Move	59	Stockings	40
Rota Stand	59	Stools perching	80
		Stools shower	76
		Styling mousse	39
		Suction catheters	13
		Suction machines	89
		Superdent tablets	40
		Surgical trolleys	85

Swabs	11	Swabs gauze	21
Swabs woven	21	Sweeping brush	30
Syringe drivers	90	Syringes	11
T		Table linen	31
Tableware	32	Talc	39
Tea towel	29	Test strips	13
Thermometers	87	Tights	40
Toe nail clippers	39	Toe washer	70
Toilet brush set	30	Toilet cleaner	28
Toilet paper	35	Toilet paper dispenser	36
Toilet seats raised	77	Toilet surround	78
Toilet surround	78	Toothpaste	40
Torches - pen	20	Tourniquet quick release	22
Tracheotomy tube holder	11	Transfer boards	58
Transfer boards	58	Transfer slide sheets	58
Transfer slide sheets	58	Transit wheelchair	60
Tray covers	31	Triple clean	26
Triple clean	26	Trolleys cylinder	85
Trolleys cylinder	85	Trolleys drug	86
Trolleys drug	86	Trolleys laundry	86
Trolleys laundry	86	Trolleys medical	85
Trolleys medical	85	Trolleys surgical	85
Trolleys surgical	85	Tubing	13
Tubing	13	Turning products	59
Turning products	59	Turntables	60
Turntables	60	U	
U		Underlay mattresses	45
Underlay mattresses	45	Urinals	15
Urinals	15	V	
V		Vacuum cleaner bags	30
Vacuum cleaner bags	30	Vacuum cleaners	30
Vacuum cleaners	30	Visitors book	87
Visitors book	87	W	
W		Walker trolleys	80
Walker trolleys	80	Walking aids	80
Walking aids	80	Ward screen	82
Ward screen	82	Wash cream	9
Wash cream	9	Wash mitt	9
Wash mitt	9		

Wash up liquid	28
Washroom cleaner	26
Waterproof bedding protection	65
Wheelchair scales	73
Wheelchair strap	79
Wheelchairs	78
Wipes hard surface	8
Wipes patient	8
Wound closure	20
X	
X-Ray cassette sleeves	60



Quotation Request Form

Customer Name:	Telephone No.:
Address:	Fax No.:
	Email Address:
Your Name: Mr/Mrs/Miss	Your Account Ref:
	Date:

Product Code:	Description:	Page No.:	Quantity:	Price Currently Paying (Optional)

Fax back to us on:

01423 332440

or contact us at: sales@andwayhealthcare.org.uk or www.andwayhealthcare.com

What makes us different?

- Friendly and professional sales staff
- Quality customer service - quick response time
- Able to provide new and specific products for our customers
- Competitive pricing on all our product ranges
- Stock a comprehensive range of products, known for performance, quality and value
- Reliable, on-time service

Our Service:

Customer Care is high on our agenda, we listen to our customer feedback, and are able to provide Quality Services and Care Solutions.

At Andway Healthcare we work together with Nursing Homes to fulfil our aim to assist 'Care Homes in caring' - by providing a comprehensive range of Nursing and Hygiene consumable products, equipment and services. We will help ensure the smooth running of your business by providing effective products, on-time solutions and professional friendly advice.

Our main KPI is to respond to all customer requests and queries within an hour so that we can ensure our customers receive the best possible service, so that your organisation is cared for rightly and a good working relationship is maintained.

Thank you

- Thank you for browsing through our catalogue. We look forward to speaking with you on the phone, so contact our team with your enquiries by calling anytime from Monday to Friday between 8.00am to 5.00pm on 01423 331000.
- Alternatively you can send your enquiry through our website on: www.andwayhealthcare.com/Contact_Us.
Simply submit a request on any product or service you require and we will respond quickly with a solution and price.
- If you prefer you can send your enquiry through to our sales desk; email sales@andwayhealthcare.org.uk or fax 01423 332440 and our sales team will be in touch with you shortly.

'Providing Quality Supplies and Care Solutions'

Terms & conditions

TERMS AND CONDITIONS OF SALE

A. J & D LEDGEWAY T/A ANDWAY HEALTHCARE

The Buyer's attention is in particular drawn to the provisions of condition 10.4 which set out the limitations on the Partnership's liability.

1. INTERPRETATION

1.1 The definitions and rules of interpretation in this condition apply in these conditions.

Account: agreed credit or discount terms with the Partnership.

Buyer: the person, firm or company who purchases Goods or hires Hired Goods from the Partnership.

Contract: any contract between the Partnership and the Buyer for the sale and purchase of the Goods or supply of Hired Goods or Services formed in accordance with condition 2.6, incorporating these conditions.

Delivery Point: the place where delivery of the Goods or Hired Goods is to take place under condition 4.

Goods: any goods (including any instalment/part of them) agreed in the Contract to be supplied to the Buyer by the Partnership (including any part or parts of them) in accordance with these conditions.

Loss: any claim, damage, demand, expense, fee, fine, payment, proceeding, liability, loss or penalty.

Hired Goods: any goods agreed in the Contract to be hired by the Partnership to the Buyer (including any part or parts of them) in accordance with condition 13.

Hire Period: the period for which any Hired Goods are to be hired by the Buyer as set out in the Partnership's written acknowledgement of the Buyer's order for such Hired Goods.

Partnership: the partnership A. J & D Ledgeway trading as Andway Healthcare.

Quotation: a quotation from the Partnership for the supply of Goods, Hired Goods or Services, whether in writing (by email, fax or letter), or given orally, to the Buyer.

Services: any repair and/or maintenance services provided by the Partnership in respect of the Goods.

Total Loss: means, in relation to any item of Hired Goods, any actual, constructive, compromised, agreed or arranged total loss (in the conclusive opinion of the insurer of the Hired Goods) as a result of the loss, destruction, theft, damage beyond economic repair, compulsory acquisition, requisition, forfeiture, seizure or confiscation of such item of Hired Goods.

1.2 A reference to a law is a reference to it as it is in force for the time being taking account of any amendment, extension, application or re-enactment and includes any subordinate legislation for the time being in force made under it.

1.3 Words in the singular include the plural and in the plural include the singular.

1.4 A reference to one gender includes a reference to the other gender.

1.5 Condition headings do not affect the interpretation of these conditions.

2. APPLICATION OF TERMS

2.1 Subject to any variation under condition 2.3 the Contract shall be on these conditions to the exclusion of all other terms and conditions (including any terms or conditions which the Buyer purports to apply under any purchase order, confirmation of order, specification or other document).

2.2 No terms or conditions endorsed on, delivered with or contained in the Buyer's purchase order, confirmation of order, specification or other document shall form part of the Contract simply as a result of such document being referred to in the Contract.

2.3 These conditions apply to all the Partnership's sales and any variation to these conditions and any representations about the Goods, Hired Goods or Services shall have no effect unless expressly agreed in writing and signed by Andrew Ledgeway on behalf of the Partnership. The Buyer acknowledges that it has not relied on any statement, promise or representation made or given by or on behalf of the Partnership which is not set out in the Contract. Nothing in this condition shall exclude or limit the Partnership's liability for fraudulent misrepresentation.

2.4 Each order or acceptance of a Quotation for Goods, Hired Goods or Services by the Buyer from the Partnership shall be deemed to be an offer by the Buyer to buy Goods or Services or hire Hired Goods as the case may be subject to these conditions. Orders must refer to codes and descriptions of the relevant Goods or Hired Goods.

2.5 No order placed by the Buyer shall be deemed to be accepted by the Partnership until a written acknowledgement of order is issued by the Partnership or (if earlier) the Partnership delivers the Goods, Hired Goods or Services to the Buyer.

2.6 A legally binding contract is formed between the Buyer and the Partnership on the date on which the Buyer receives the Partnership's written acknowledgement of its order for Goods, Hired Goods or Services, or (if earlier) on the date on which the Partnership delivers the Goods, Hired Goods or Services ordered by the Buyer.

2.7 The Buyer shall ensure that the terms of its order and any applicable specification are complete and accurate.

2.8 Any Quotation is given on the basis that no Contract shall come into existence until the Partnership despatches an acknowledgement of order to the Buyer or (if earlier) delivers the Goods, Hired Goods or Services to the Buyer. Any Quotation is valid for a period of 30 days only from its date, provided that the Partnership has not previously withdrawn it.

3. DESCRIPTION

3.1 The quantity and description of the Goods, Hired Goods or Services to be supplied under the Contract shall be as set out in the Quotation or the Partnership's acknowledgement of order, which must include the relevant Goods codes.

3.2 All samples, drawings, descriptive matter, specifications and advertising issued by the Partnership and any descriptions or illustrations contained in the Partnership's literature are issued or published for the sole purpose of giving an approximate idea of the Goods or Hired Goods described in them. They shall not form part of the Contract and this is not a sale by sample.

3.3 Goods are sold and Hired Goods are hired by reference to description and not product codes. Product codes relating to Goods or Hired Goods are listed solely for identification purposes and no warranties/warranties by suppliers/manufacturers of Goods or Hired Goods may be inferred from such codes.

3.4 The Partnership shall, upon written request of the Buyer, provide the Services to the Buyer on such terms as set out herein.

4. DELIVERY

4.1 Orders for Goods or Hired Goods by the Buyer to destinations within the UK with a value in excess of £100 (excluding VAT) may not, at the Partnership's discretion, carry delivery charges. However, the Partnership reserves the right to pass on to the Buyer any packaging, carriage or other charges including charges for the supply of Goods or Hired Goods to special order.

4.2 Unless otherwise agreed in writing by the Partnership, delivery of the Goods or Hired Goods shall take place at the Partnership's place of business.

4.3 Any dates specified by the Partnership for delivery of the Goods or Hired Goods are intended to be an estimate and time for delivery may not be made of the essence by notice. The Goods or Hired Goods may be delivered by the Partnership in advance of the quoted delivery date on giving the Buyer reasonable notice. If no dates are so specified, delivery shall be within a reasonable time.

4.4 Subject to the other provisions of these conditions the Partnership shall not be liable for any direct, indirect or consequential loss (all three of which terms include, without limitation, pure economic loss, loss of profits, loss of business, depletion of goodwill and similar loss), costs, damages, charges or expenses caused directly or indirectly by any delay in the delivery of the Goods or Hired Goods (even if caused by the Partnership's negligence), nor shall any delay entitle the Buyer to terminate or rescind the Contract unless such delay exceeds 180 days.

4.5 If for any reason the Buyer fails to accept delivery of any of the Goods or Hired Goods when they are ready for delivery, or the Partnership is unable to deliver the Goods or Hired Goods on time because the Buyer has not provided appropriate instructions, documents, licences or authorisations:

- risk in the Goods or Hired Goods shall pass to the Buyer (including for loss or damage caused by the Partnership's negligence);
- the Goods or Hired Goods shall be deemed to have been delivered; and
- the Partnership may store the Goods or Hired Goods until delivery, whereupon the Buyer shall be liable for all related costs and expenses (including, without limitation, storage and insurance).

4.6 The Buyer shall provide at the Delivery Point and at its expense adequate and appropriate equipment and manual labour for loading the Goods or Hired Goods.

4.7 If the Partnership delivers to the Buyer Goods which are the nearest available alternative to those ordered, the Buyer shall not be entitled to object to or reject the Goods or any of them by reason of the difference provided that the Company does not have Goods of the exact specification ordered in stock.

4.8 The Partnership may deliver the Goods or Hired Goods by separate instalments. Each separate instalment shall be invoiced and paid for in accordance with the provisions of the Contract.

4.9 Each instalment shall be a separate Contract and no cancellation or termination of any one Contract relating to an instalment shall entitle the Buyer to repudiate or cancel any other Contract or instalment.

4.10 It shall be the responsibility of the Buyer to check the Goods or Hired Goods on delivery and notify the Partnership in writing within 24 hours of the time of delivery if it considers that the Goods or Hired Goods or any part of them have been damaged prior to or in transit.

4.11 The Partnership shall at its option repair or replace any Goods or Hired Goods referred to in condition 4.10 (or the defective part as the case may be) provided that:

- the Partnership, after examination of such Goods, Hired Goods or parts, deems them to have been damaged on or prior to delivery to the Buyer;
- the Partnership shall be under no liability and neither this condition nor condition 4.10 applies in respect of any damage arising from the negligence of the Buyer or the failure by the Buyer to follow any instructions of the Partnership (whether oral or in writing) in relation to the handling/storage of the Goods or Hired Goods.

4.12 The provisions of condition 9.4 shall apply in relation to any replacement Goods or Hired Goods supplied in accordance with condition 4.11.

5. NON-DELIVERY

5.1 The quantity of any consignment of Goods or Hired Goods as recorded by the Partnership on despatch from the Partnership's place of business shall be conclusive evidence of the quantity received by the Buyer on delivery unless the Buyer can provide conclusive evidence proving the contrary.

5.2 The Partnership shall not be liable for any non-delivery of Goods or Hired Goods (even if caused by the Partnership's negligence) unless the Buyer gives written notice to the Partnership of the non-delivery within 3 days of the date when the Goods or Hired Goods should in the ordinary course of events have been received.

5.3 Any liability of the Partnership for non-delivery of the Goods shall be limited to replacing the Goods or Hired Goods within a reasonable time or issuing a credit note at the pro rata Contract rate against any invoice raised for such Goods or Hired Goods.

6. RISK/TITLE

6.1 The Goods or Hired Goods are at the risk of the Buyer from the time of delivery.

6.2 Hired Goods shall belong to the Partnership and title to, and ownership of, the Hired Goods shall remain vested in the Partnership.

6.3 Goods loaned to the Buyer or provided to the Buyer for demonstration purposes shall belong to the Partnership and title to, and ownership of, such goods shall remain vested in the Partnership.

6.4 The Buyer shall have no right, title or interest in or to any part of any item of the Hired Goods except the right to hire the Hired Goods in accordance with the Contract.

6.5 The Buyer shall not attempt or hold itself out as having any power to sell, charge or otherwise encumber or to sell or otherwise dispose of any item of Hired Goods or any interest in any item of Hired Goods.

6.6 The Buyer shall not be entitled to encumber or in any way charge any Hired Goods.

6.7 Ownership of the Goods shall not pass to the Buyer until the Partnership has received in full (in cash or cleared funds) all sums due to it in respect of:

- the Goods; and
- all other sums which are or which become due to the Partnership from the Buyer on any account.

6.8 Until ownership of the Goods has passed to the Buyer, the Buyer shall:

- hold the Goods on a fiduciary basis as the Partnership's bailee;
- store the Goods (at no cost to the Partnership) separately from all other goods of the Buyer or any third party in such a way that they remain readily identifiable as the Partnership's property and if necessary label them as such;
- not destroy, deface or obscure any identifying mark or packaging on or relating to the Goods; and
- maintain the Goods in satisfactory condition and keep them insured on the Partnership's behalf for their full price against all risks to the reasonable satisfaction of the Partnership. On request the Buyer shall produce the policy of insurance to the Partnership.

6.9 The Buyer may resell the Goods before ownership has passed to it solely on the following conditions:

- any sale shall be effected in the ordinary course of the Buyer's business at full market value; and
- any such sale shall be a sale of the Partnership's property on the Buyer's own behalf and the Buyer shall deal as principal when making such a sale.

6.10 The Buyer's right to possession of the Goods or Hired Goods shall terminate immediately if:

- the Buyer has a bankruptcy order made against him or makes an arrangement or composition with his creditors, or otherwise takes the benefit of any statutory provision for the time being in force for the relief of insolvent debtors, or (being a body corporate) convenes a meeting of creditors (whether formal or informal), or enters into liquidation (whether voluntary or compulsory) except a solvent voluntary liquidation for the purpose only of reconstruction or amalgamation, or has a receiver and/or manager, administrator or administrative receiver appointed of its undertaking or any part thereof, or documents are filed with the court for the appointment of an administrator of the Buyer or notice of intention to appoint an administrator is given by the Buyer or its directors or by a qualifying floating charge holder (as defined in paragraph 14 of Schedule B1 to the Insolvency Act 1986), or a resolution is passed or a petition presented to any court for the winding-up of the Buyer or for the granting of an administration order in respect of the Buyer, or any proceedings are commenced relating to the insolvency or possible insolvency of the Buyer; or
- the Buyer suffers or allows any execution, whether legal or equitable, to be levied on his/its property or obtained against him/it, or fails to observe or perform any of his/its obligations under the Contract or any other contract between the Partnership and the Buyer, or is unable to pay its debts within the meaning of section 123 of the Insolvency Act 1986 or the Buyer ceases to trade; or
- the Buyer encumbers or in any way charges any of the Goods or Hired Goods.

6.11 The Partnership shall be entitled to recover payment for the Goods notwithstanding that ownership of any of the Goods has not passed from the Partnership.

6.12 The Buyer grants the Partnership, its agents and employees an irrevocable licence at any time to enter any premises where the Goods or Hired Goods are or may be stored in order to inspect them, or, where the Buyer's right to possession has terminated, to recover them.

6.13 Where the Partnership is unable to determine whether any Goods are the goods in respect of which the Buyer's right to possession has terminated, the Buyer shall be deemed to have sold all goods of the kind sold by the Partnership to the Buyer in the order in which they were invoiced to the Buyer.

6.14 On termination of the Contract, howsoever caused, the Partnership's (but not the Buyer's) rights contained in this condition 6 shall remain in effect.

7. PRICE

7.1 Unless otherwise agreed by the Partnership in writing, the price for the Goods or the Hired Goods, and/or Services shall be the price set out in the Partnership's catalogue or price list, or in the absence of a price in such documents, the catalogue of the manufacturer of the Goods, as published on the date of delivery or deemed delivery and all prices listed in quotations or written acknowledgements of order issued by the Partnership relate exclusively to the quantities of Goods stipulated therein.

7.2 The Partnership reserves the right by giving written notice to the Buyer at any time before delivery to increase the price of the Goods, Hired Goods or Services to reflect any increase in the cost to the Partnership which is due to any factor beyond the control of the

Partnership (such as without limitation any foreign exchange fluctuation, currency, regulation, alteration of duties, significant increase in the costs of labour, materials or other costs of manufacture) any change in delivery dates, quantities or specifications for the Goods or Hired Goods which is requested by the Buyer or any delay caused by any instructions of the Buyer or failure of the Buyer to give the Partnership adequate information or instructions.

7.3 The price for the Goods, Hired Goods and/or Services shall be exclusive of any value added tax. Certain products or equipment (in respect of which details may be requested from the Partnership) may be zero rated. All costs or charges in relation to packaging, loading, unloading, carriage and insurance, the Buyer shall pay in addition when it is due to pay for the Goods or Hired Goods.

8. PAYMENT

8.1 The Partnership's invoices shall be raised and dated on the date of despatch of the Goods or Hired Goods from the Partnership's (or its agent's) warehouse.

8.2 Subject to condition 8.6, payment of the price for the Goods, Hired Goods and/or Services is due in pounds sterling within 30 days of the date stipulated on the Partnership's invoice, and the Partnership shall be entitled to recover the price notwithstanding that delivery may not have taken place and the property in the Goods may not have passed to the Buyer.

8.3 If the Buyer does not have an Account with the Partnership or in respect of any invoice marked 'COD', payment becomes due immediately on delivery/deemed delivery and the Partnership may take back the Goods or Hired Goods immediately in the event that such payment is not made by the Buyer.

8.4 Time for payment shall be of the essence.

8.5 No payment shall be deemed to have been received until the Partnership has received cleared funds.

8.6 All payments payable to the Partnership under the Contract shall become due immediately on its termination despite any other provision.

8.7 The Buyer shall make all payments due under the Contract in full without any deduction whether by way of set-off, counterclaim, discount, abatement or otherwise unless the Buyer has a valid court order requiring an amount equal to such deduction to be paid by the Partnership to the Buyer.

8.8 If the Buyer fails to pay the Partnership any sum due pursuant to the Contract, then without any prejudice to any other right or remedy available to the Seller:

- the Buyer shall be liable to pay interest to the Partnership on such sum from the due date for payment at the monthly rate of 2% above the base lending rate from time to time of NatWest Bank Plc, accruing on a daily basis until payment is made, whether before or after any judgment. The Partnership reserves the right to claim interest under the Late Payment of Commercial Debts (Interest) Act 1998;
- the Partnership may cancel the Contract or suspend any further deliveries to the Buyer;
- the Partnership may appropriate any payment made by the Buyer to such of the Goods or Hired Goods (or the goods supplied under any other contract between the Buyer and the Partnership) as the Partnership may think fit (notwithstanding any purported appropriation by the Buyer) and retain any Goods under repair.

8.9 If the Partnership so requires, the Buyer shall procure that some or all of the directors, partners, or owners of the Buyer, as the case may be, shall enter into personal guarantees for the purposes of guaranteeing all payment obligations of the Buyer under the Contract.

9. QUALITY

9.1 All warranties given by the Partnership are limited to those made in writing by the original manufacturer of the Goods or the Hired Goods. The Partnership shall endeavour to transfer to the Buyer the benefit of any warranty or guarantee relating to the Goods or Hired Goods which has been given to the Partnership.

9.2 The Partnership or any of its representatives do not warrant that on delivery or after repair the Goods or Hired Goods shall:

- be of satisfactory quality within the meaning of the Sale of Goods Act 1979; or
- be reasonably fit for purpose.

9.3 If within 12 months from the date of delivery of the Goods, the Partnership deems the Goods or Hired Goods to be faulty, the Partnership shall at its option repair or replace such goods (or the defective part) or refund the price of such goods at the pro rata Contract rate provided that:

- the Buyer shall return the goods (or the part of such goods which is defective) and packaging to the Partnership;
- the Partnership, after examination of such goods/parts, deems them faulty;
- the Buyer, within 3 days of the date of delivery/deemed delivery requests in writing to return the goods to the Partnership;
- the Partnership agrees to the request as set out in condition 9.3(c) above;
- the Buyer bears all expenses, costs and charges relating to carriage (including packaging) incurred in returning the goods to the Partnership and incurred by the Partnership sending the goods back to the Buyer;
- non-stock items made by special order may not under any circumstances be returned to the Partnership; or
- the Partnership shall be under no liability and this condition does not apply in respect of any defect arising from fair wear and tear, wilful damage, negligence, abnormal working conditions, failure to follow the Partnership's instructions (whether oral or in writing) misuse or alteration or repair of the goods without the Partnership's approval.

9.4 Any Goods or Hire Goods replaced shall belong to the Partnership and any repaired or replacement goods shall be guaranteed on these terms as set out in condition 9.1.

10. LIMITATION OF LIABILITY

10.1 Subject to condition 4, condition 5 and condition 9, the following provisions set out the entire financial liability of the Partnership (including any liability for the acts or omissions of its employees, agents and sub-contractors) to the Buyer in respect of:

- any breach of these conditions;
- any use made or resale by the Buyer of any of the Goods, or of any product incorporating any of the Goods;
- any representation, statement or tortious act or omission including negligence arising under or in connection with the Contract; and
- (d) provision of the Services.

10.2 All warranties, conditions and other terms implied by statute or common law (save for the conditions implied by section 12 of the Sale of Goods Act 1979) are, to the fullest extent permitted by law, excluded from the Contract.

10.3 Nothing in these conditions excludes or limits the liability of the Partnership:

- for death or personal injury caused by the Partnership's negligence; or
- under section 2(3), Consumer Protection Act 1987; or
- for any matter which it would be illegal for the Partnership to exclude or attempt to exclude its liability; or
- for fraud or fraudulent misrepresentation; or
- under section 6(1), Unfair Contract Terms Act 1977.

10.4 Subject to condition 10.2 and condition 10.3:

- the Partnership's total liability in contract, tort (including negligence or breach of statutory duty), misrepresentation, restitution or otherwise, arising in connection with the performance or contemplated performance of the Contract shall be limited to the Contract price or the amount payable under any insurance policy held by the Partnership in respect of any losses for which the Partnership is liable under the Contract whichever is greater; and
- the Partnership shall not be liable to the Buyer for loss of profit, loss of business, or depletion of goodwill in each case whether direct, indirect or consequential, or any claims for consequential compensation whatsoever (howsoever caused) which arise out of or in connection with the Contract.

11. ASSIGNMENT

11.1 The Partnership may assign the Contract or any part of it to any person, firm or company.

11.2 The Buyer shall not be entitled to assign the Contract or any part of it without the prior written consent of the Partnership.

12. FORCE MAJEURE

The Partnership reserves the right to defer the date of delivery or to cancel the Contract or reduce the volume of the Goods ordered by

Terms & conditions

the Buyer (without liability to the Buyer) if it is prevented from or delayed in the carrying on of its business due to circumstances beyond the reasonable control of the Partnership including, without limitation, acts of God, governmental actions, war or national emergency, acts of terrorism, protests, riot, civil commotion, fire, explosion, flood, epidemic, lock-outs, strikes or other labour disputes (whether or not relating to either party's workforce), or restraints or delays affecting carriers or inability or delay in obtaining supplies of adequate or suitable materials, provided that, if the event in question continues for a continuous period in excess of 60 days, the Buyer shall be entitled to give notice in writing to the Partnership to terminate the Contract.

13. HIRED GOODS

13.1 The Buyer shall hire the Hired Goods for the Hire Period.

13.2 The Buyer shall maintain each item of the Hired Goods in good, safe and serviceable condition and state of repair (fair wear and tear excepted):

- consistent with first-class operating and management practice; and
- strictly to the standard and at the service intervals recommended by the manufacturer of that item of Hire Goods and keep them insured on the Partnership's behalf for their full price against all risks to the reasonable satisfaction of the Partnership. On request the Buyer shall produce such policy or policies of insurance to the Partnership.

13.3 The Buyer shall promptly pay all premiums or other sums payable in respect of the insurance referred to in condition 13.2 and if required by the Partnership shall provide the Partnership with all relevant receipts.

13.4 The Buyer shall store and maintain the Hired Goods in accordance with the Partnership's written instructions.

13.5 The Buyer shall immediately notify the Partnership in the event that the Hired Goods come into contact with any harmful bacteria (including but not limited to MRSA and Clostridium difficile).

13.6 In the event that the Buyer notifies the Partnership pursuant to condition 13.4:

- the Buyer's right to possession of the Hired Goods shall immediately cease and the Partnership shall be entitled to enter the premises where the Hired Goods are stored and repossess the Hired Goods in accordance with condition 6.11;
- the Partnership shall provide the Buyer with goods to replace the Hired Goods, as soon as is reasonably practicable;
- the Buyer shall indemnify the Partnership against all of the Partnership's reasonable costs incurred in order to restore the Hired Goods to a reasonable and usable condition in accordance with this condition 13.6 (including without limitation the cost of collection, replacement and restoration of the contaminated goods).

13.7 In respect of Hired Goods, the Buyer acknowledges that:

- the Partnership is not the original manufacturer of the goods;
- the goods were selected by the Buyer;
- each item of the Hired Goods is satisfactory to the Buyer and suitable for the business of the Buyer and any intended use of each item of Hired Goods by the Buyer.

13.8 The Buyer shall on demand indemnify the Partnership against any Loss incurred by the Partnership at any time arising out of, resulting from, or in connection with the Total Loss of any of the Hired Goods.

13.9 The Buyer hereby undertakes that during the Hire Period:

- the Buyer shall not cause or permit any item of Hired Goods to be employed, used or operated in any manner contrary to any law or regulation;
- procure that each item of Hired Goods is employed, used or operated:
 - in a skilful, careful and proper manner;
 - only for the purpose for which it was designed;
 - in accordance with and subject to all instructions issued by the manufacturer of that item of Hired Goods and any government agency or authority; and
 - in accordance with and subject to all applicable laws and regulations.

13.10 On termination of the Hire Period in accordance with the Contract the Buyer shall at its risk and expense return the Hired Goods to the Partnership at such place in the United Kingdom as the Partnership requires. The Hired Goods shall be returned in a good, safe and serviceable condition and state of repair (fair wear and tear excepted) and otherwise in the condition required pursuant to the Contract, free of any charge or encumbrance.

13.11 On termination of the Hire Period, the Buyer shall no longer be in possession of the Hired Goods with the consent of the Partnership and the Partnership shall be entitled to retake possession of the Hired Goods if they are not returned in accordance with condition 13.10.

13.12 The Partnership may put into force and exercise all its rights and entitlements at law and may enter upon any land or premises belonging to, or in the occupation or under the control of, the Buyer where any item of Hired Goods is located for the purposes of retaking possession of that item of Hired Goods.

14. GENERAL

14.1 Each right or remedy of the Partnership under the Contract is without prejudice to any other right or remedy of the Partnership whether under the Contract or not.

14.2 If any provision of the Contract is found by any court, tribunal or administrative body of competent jurisdiction to be wholly or partly illegal, invalid, void, voidable, unenforceable or unreasonable it shall to the extent of such illegality, invalidity, voidness, voidability, unenforceability or unreasonableness be deemed severable and the remaining provisions of the Contract and the remainder of such provision shall continue in full force and effect.

14.3 Failure or delay by the Partnership in enforcing or partially enforcing any provision of the Contract shall not be construed as a waiver of any of its rights under the Contract.

14.4 Any waiver by the Partnership of any breach of, or any default under, any provision of the Contract by the Buyer shall not be deemed a waiver of any subsequent breach or default and shall in no way affect the other terms of the Contract.

14.5 The parties to the Contract do not intend that any term of the Contract shall be enforceable by virtue of the Contracts (Rights of Third Parties) Act 1999 by any person that is not a party to it.

14.6 The formation, existence, construction, performance, validity and all aspects of the Contract shall be governed by English law and the parties submit to the exclusive jurisdiction of the English courts.

15. COMMUNICATIONS

15.1 All communications between the parties about the Contract shall be in writing and delivered by hand or sent by pre-paid first class post or sent by fax:

- (in case of communications to the Partnership) to its principal place of business, (as detailed on the Quotation) or such changed address as shall be notified to the Buyer by the Partnership; or
- (in the case of the communications to the Buyer) to the registered office of the addressee (if it is a company) or (in any other case) to any address of the Buyer set out in any document which forms part of the Contract or such other address as shall be notified to the Partnership by the Buyer.

15.2 Communications shall be deemed to have been received:

- if sent by pre-paid first class post, two days (excluding Saturdays, Sundays and bank and public holidays) after posting (exclusive of the day of posting); or
- if delivered by hand, on the day of delivery; or
- if sent by fax on a working day prior to 4.00 pm, at the time of transmission and otherwise on the next working day.

15.3 Communications addressed to the Partnership shall be marked for the attention of Andrew Ledgeway.



Nursing Consumables



Hygiene & Catering



Nursing Equipment



Furniture



Interiors



Andway Healthcare, Atlantis House, Manse Lane, Knaresborough HG5 8LF

Tel: 01423 331000 Fax: 01423 332440

Email: sales@andwayhealthcare.org.uk

www.andwayhealthcare.com