

Flat panel sensor

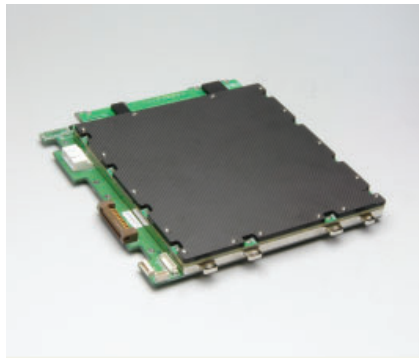

C10900D

Four selectable scan modes Photodiode area: 124.8 × 124.8 mm

The C10900D is a flat panel sensor developed for CT and panoramic imaging. It operates in 4 selectable scan modes to capture X-ray images: "Fast mode" and "Partial mode" with a pixel size of 200 × 200 μm, and "Fine mode" and "Panoramic mode" with a pixel size of 100 × 100 μm. A single C10900D serves as the X-ray sensor for both CT and panoramic imaging.

Features

- ➔ Four selectable scan modes with different number of active pixels and pixel sizes
- ➔ High-speed imaging: 280 frames/s (Panoramic mode)
- ➔ High sensitivity: 6000 LSB/mR
- ➔ Wide dynamic range
- ➔ Active area: Approx. 12 × 12 cm (1248 × 1248 pixels)
- ➔ 13-bit digital output (Fast mode, Partial mode)
- ➔ For assembly into equipment (supplied without case)

Applications

- ➔ Cone beam CT
- ➔ Digital radiography, etc.

Structure (Fast mode)

The C10900D is comprised of a sensor board and a control board. Mounted on the sensor board is a CMOS image sensor chip made up of a two-dimensional photodiode array, row-scanning vertical shift register, and 8 charge amplifier arrays. Each charge amplifier array has a horizontal shift register and consists of 78 ch charge amplifiers with CDS circuit.

CsI scintillator is directly deposited on the two-dimensional photodiode array. X-rays incident on the scintillator are converted to fluorescence, which then enters the two-dimensional photodiode array where electric charge is accumulated in each pixel according to the light intensity. The accumulated charge on each row is sequentially selected by the row-scanning vertical shift register, transferred to the amplifiers through the data line, and converted to a voltage signal. Then an analog signal is sent out from each amplifier array by scanning the horizontal shift register.

The control board converts the analog signal into a 13-bit digital signal, which is then sent to a frame grabber board as a 13-bit parallel output through one port.

This product is bare board type for installation into equipment and is not covered with a metal shielded case. See "Notice" for details on EMC.

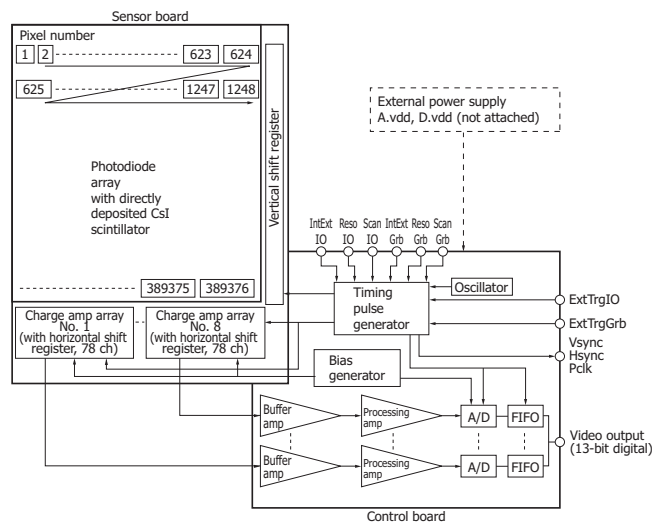

Note: Signals are read out in order of pixel number.

KACCC0487EA

Selectable scan modes

Four scan modes are available with different number of active pixels and pixel sizes.

Active area for each scan mode

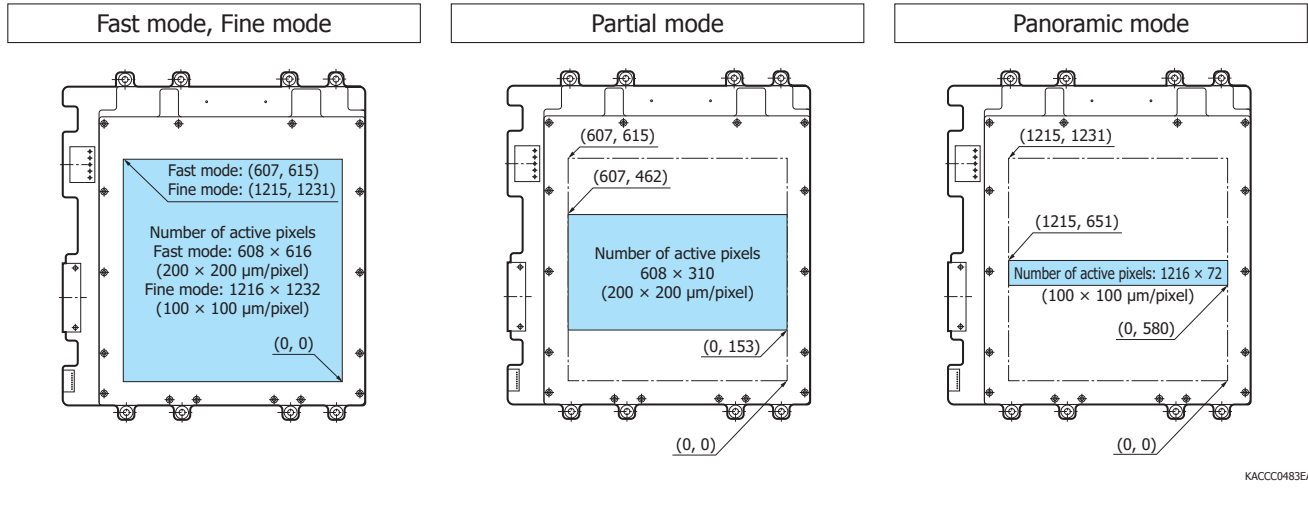

General ratings

Parameter	Fast mode	Partial mode	Fine mode	Panoramic mode	Unit
Pixel size	200 × 200	200 × 200	100 × 100	100 × 100	μm
Photodiode area	124.8 × 124.8				mm
Number of pixels (H × V)	624 × 624		1248 × 1248		pixels
Active area	121.6 × 123.2	121.6 × 62.0	121.6 × 123.2	121.6 × 7.2	mm
Number of active pixels (H × V)	608 × 616	608 × 310	1216 × 1232	1216 × 72	pixels
Readout	Charge amplifier array				-
Video output (Data1-13)	LVDS (differential) 13-bit		LVDS (differential) 12-bit		-
Output data rate	17.68	17.68	35.35	35.35	MHz
Synchronous signal (Vsync, Hsync, Pclk)	LVDS (differential)				-
ExtTrgGrb, IntExtGrb, ResoGrb, ScanGrb, ExtTrgIO, IntExtIO, ResoIO, ScanIO	TTL				-
Scintillator	Directly deposited CsI				-

Absolute maximum ratings (Ta=25 °C)

Parameter	Symbol	Value	Unit
Supply voltage for digital circuitry (+5 V)	D.vdd	+6.0	V
Supply voltage for analog circuitry (+5 V)	A.vdd	+6.0	V
Input voltage (ExtTrgGrb, IntExtGrb, ResoGrb, ScanGrb, ExtTrgIO, IntExtIO, ResoIO, ScanIO)	Vin	0 to 6.0	V
Operating temperature *1	Topr	0 to +40	°C
Storage temperature *1	Tstg	-10 to +60	°C
Incident X-ray energy	-	90	kVp

*1: No condensation

Specifications (Typ. Ta=25 °C, A.vdd=5.0 V, D.vdd=5.0 V)

Fast mode

Parameter	Symbol	Min.	Typ.	Max.	Unit
Frame rate	Sf(int)	33.2	35	-	frames/s
Noise (rms) *2	N(rms)	-	2900 (2.3 LSB)	-	electrons
Saturation charge	Csat	-	10.5	-	M electrons
Sensitivity *3	S	4800	6000	-	LSB/mR
Resolution *4	Reso	2	2.5	-	line pairs/mm
Dynamic range	-	-	3600	-	-

Partial mode

Parameter	Symbol	Min.	Typ.	Max.	Unit
Frame rate	Sf(int)	66.5	70	-	frames/s
Noise (rms) *2	N(rms)	-	2900 (2.3 LSB)	-	electrons
Saturation charge	Csat	-	10.5	-	M electrons
Sensitivity *3	S	4800	6000	-	LSB/mR
Resolution *4	Reso	2	2.5	-	line pairs/mm
Dynamic range	-	-	3600	-	-

Fine mode

Parameter	Symbol	Min.	Typ.	Max.	Unit
Frame rate	Sf(int)	16.1	17	-	frames/s
Noise (rms) *2	N(rms)	-	1300 (2.4 LSB)	-	electrons
Saturation charge	Csat	-	2.3	-	M electrons
Sensitivity *3	S	2800	3500	-	LSB/mR
Resolution *4	Reso	3.6	4.5	-	line pairs/mm
Dynamic range	-	-	1700	-	-

Panoramic mode

Parameter	Symbol	Min.	Typ.	Max.	Unit
Frame rate	Sf(int)	266	280	-	frames/s
Noise (rms) *2	N(rms)	-	1300 (2.4 LSB)	-	electrons
Saturation charge	Csat	-	2.3	-	M electrons
Sensitivity *3	S	2800	3500	-	LSB/mR
Resolution *4	Reso	3.6	4.5	-	line pairs/mm
Dynamic range	-	-	1700	-	-

*2: Internal trigger mode

*3: At 80 kVp, acrylic filter 170 mm

*4: Spatial frequency at CTF=5 %

Note: X-ray energy range is 20 k to 90 kVp.

Resolution

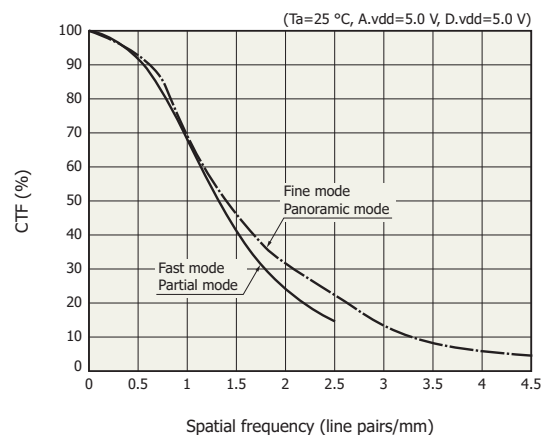

KACC0204EA

Other specifications (Fine mode, Typ. Ta=25 °C, A.vdd=5.0 V, D.vdd=5.0 V)

Parameter	Symbol	Min.	Typ.	Max.	Unit
Defect line *5	-	-	-	8	lines
Blemish *6	-	-	-	600	µm
Non-uniformity of sensitivity *6	-	-	-	4	%
Defect cluster *6	-	Not allowed			-
Bright line output adjacent to a defect line *6	-	-	-	120	%
Output offset *7	-	-	65	200	LSB

*5: A defect line is a horizontal or vertical line containing 4 or more cosecutive pixels located, that produce 1/8 of the average sensitivity of the surrounding pixels. Adjacent defective lines are not allowed in the vertical or horizontal directions.

*6: See P. 9, "Description of terms (Fine mode)"

*7: Average of all effective pixels in single operation at Sf(int)

Timing chart

Internal trigger mode

To acquire images through a frame grabber board, write parameters in the software program or parameter file by referring to the following timing chart and description.

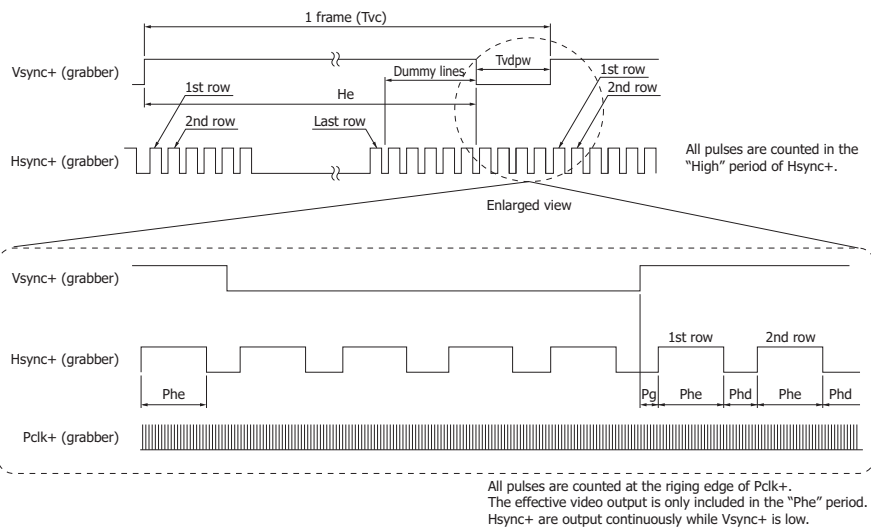

KACCC0361EC

Parameters		Fast mode	Partial mode	Fine mode	Panoramic mode
He	Dummy line	0	0	0	0
	Effective line	616	310	1232	72
	Dummy line	8	0	16	0
Phe	Dummy pixel	8	8	16	16
	Effective pixel	608	608	1216	1216
	Dummy pixel	8	8	16	16
Phd		177	177	354	354
Pg		157	157	311	346

Note: "He" is the Hsync count. Phe, Phd and Pg are the Pclk count.

External trigger mode

To acquire images in external trigger mode, input an external trigger pulse as shown below. When the time T_{vd} has passed after the rising edge of the external trigger pulse, synchronous signals and video signals are obtained.

When used in synchronization with a pulsed X-ray source, X-rays should be irradiated during the T_{xray} period.

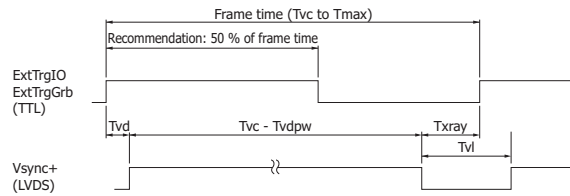

H_{sync+} , P_{clk+} and effective video output are the same as internal trigger mode.
 T_{max} is defined as the reciprocal of the minimum value of Sf (ext).
 $T_{xray} = \text{Frame time} - T_{vd} - (T_{vc} - T_{vdpw})$
 $T_{vl} = \text{Frame time} - (T_{vc} - T_{vdpw})$

KACCC0489EA

(Typ.)

Parameter		Symbol	Fast mode	Partial mode	Fine mode	Panoramic mode	Unit
Vsync	Delay time (only external trigger mode)	T_{vd}	83	110	81	140	μs
	Cycle time (internal trigger mode)	T_{vc}	28.5	14.2	56.7	3.56	ms
	Pulse width of V_{sync+} in low period (internal trigger mode)	T_{vdpw}	170	120	170	290	μs

Note: The numbers of significant figures is two. (except T_{vc})

To operate the sensor in external trigger mode, set the frame rate in the range shown below.

■ Frame rate range in external trigger mode

Scan mode	Frame rate: $Sf(\text{ext})$	Unit
Fast mode	$Sf(\text{int})$ to 10	frames/s
Partial mode		
Fine mode		
Panoramic mode	$Sf(\text{int})$ to 50	frames/s

■ Trigger mode selection

■ Setting via 40-pin receptacle

Mode	Pin No. A17 (ExtTrgGrb)	Pin No. B17 (IntExtGrb)
Internal trigger mode	- (Input signal is ignored)	Low
External trigger mode	Rectangular signal (See the above figure.)	High

When selecting the trigger mode via the 40-pin receptacle, do not connect to the external I/O connector.

■ Setting via external I/O connector

Operating mode	External I/O connector pin No.		40-pin receptacle pin No.
	Pin No. 1 (IntExtIO)	Pin No. 2 (ExtTrgIO)	Pin No. A17 (ExtTrgGrb), Pin No. B17 (IntExtGrb)
Internal trigger mode	Low	- (Input signal is ignored)	High or Open
External trigger mode	High	Rectangular signal (See the above figure.)	

Scan mode selection

Setting via 40-pin receptacle

Scan mode	Pixel size	Pin No. A15 (ResoGrb)	Pin No. A16 (ScanGrb)
Fast mode	200 μm	High	High
Partial mode			Low
Fine mode	100 μm	Low	High
Panoramic mode			Low

When selecting the scan mode via the 40-pin receptacle, do not connect to the external I/O connector.

Setting via external I/O connector

Scan mode	Pixel size	External I/O connector pin No.		40-pin receptacle pin No.	
		No. 3 (ResoIO)	No. 4 (ScanIO)	Pin No. A15 (ResoGrb)	Pin No. A16 (ScanGrb)
Fast mode	200 μm	High	High	High or Open	
Partial mode			Low		
Fine mode	100 μm	Low	High		
Panoramic mode			Low		

System requirements

To operate the C10900D at full performance, the following system and peripherals are required.

- PC: PC running on Windows XP
- Frame grabber board: Monochrome 16 bits or more, pixel clock 15.15 MHz or more, LVDS interface synchronous signal
- Power source: A.vdd = +5.0 \pm 0.1 V (900 mA), D.vdd = +5.0 \pm 0.1 V (350 mA)
 - The voltages described above are specified at the flat panel sensor side.
 - Please use a low noise series power supply. (Avoid using a switching power supply.)
 - Install a noise filter on the AC power input line to prevent surges on the AC line.
 - Always ground the fixing plate to avoid the effects of noise from peripheral devices.

The power cable, frame grabber board cable, earth cable, image acquisition software, and image processing libraries are excluded from the flat panel sensor.

■ Pin assignment of 40-pin receptacle

Pin No.	Signal	Pin No.	Signal
A1	Data1+ (LSB)	B1	Data1- (LSB)
A2	Data2+	B2	Data2-
A3	Data3+	B3	Data3-
A4	Data4+	B4	Data4-
A5	Data5+	B5	Data5-
A6	Data6+	B6	Data6-
A7	Data7+	B7	Data7-
A8	Data8+	B8	Data8-
A9	Data9+	B9	Data9-
A10	Data10+	B10	Data10-
A11	Data11+	B11	Data11-
A12	Data12+	B12	Data12-
A13	Data13+ (MSB)	B13	Data13- (MSB)
A14	Reserved	B14	Reserved
A15	ResoGrb (TTL)	B15	GND
A16	ScanGrb (TTL)	B16	GND
A17	ExtTrgGrb (TTL)	B17	IntExtGrb (TTL)
A18	Vsync+	B18	Vsync-
A19	Hsync+	B19	Hsync-
A20	Pclk+	B20	Pclk-

Unless otherwise noted, signal level is LVDS.

40-pin receptacle: 8931E-040-178LF (KEL Corporation)

Mating plug: 8925R-040-179F (KEL Corporation)

Pins described "Reserved" are prepared for an extension of the future.

Do not connect any signal or power or GND to this plug.

■ Pin assignment of external I/O connector

Pin No.	signal	Setting	Function
1	IntExtIO (TTL)	Low	Internal trigger mode
		High	External trigger mode
2	ExtTrgIO (TTL)	-	Trigger signal Input under the external mode
3	ResoIO (TTL)	Low	Pixel size: 100 × 100 μm
		High	Pixel size: 200 × 200 μm
4	ScanIO (TTL)	Low	Panoramic mode/Partial mode
		High	Fine mode/Fast mode
5	Reserved	-	-
6	Reserved	-	-
7	Reserved	-	-
8	Digital GND	-	Digital GND

8-pin receptacle 53048-0810 made by Molex Japan Co., Ltd.

Matins plug 51021-0800 made by Molex Japan Co., Ltd.

■ Power pin assignment

Pin No.	Signal
1	Digital GND
2	Digital +5 V
3	Analog GND
4	Analog +5 V
5	Shield (Analog GND)

Power plug: 53259-0529 (Molex Japan Co., Ltd.)

Power receptacle: 51067-0500 (Molex Japan Co., Ltd.)

Connection example

Install the frame grabber board into the PC by the manufacture’s instructions. When a general-purpose frame grabber board with I/O control is used, the trigger mode can be set by controlling IntExtGrb and ExtTrgGrb through the I/O line. The scan mode can be set by controlling ResoGrb and ScanGrb. The trigger mode can also be set by controlling IntExtIO and ExtTrgIO via the external I/O connector. The scan mode can be set by controlling ResoIO and ScanIO.

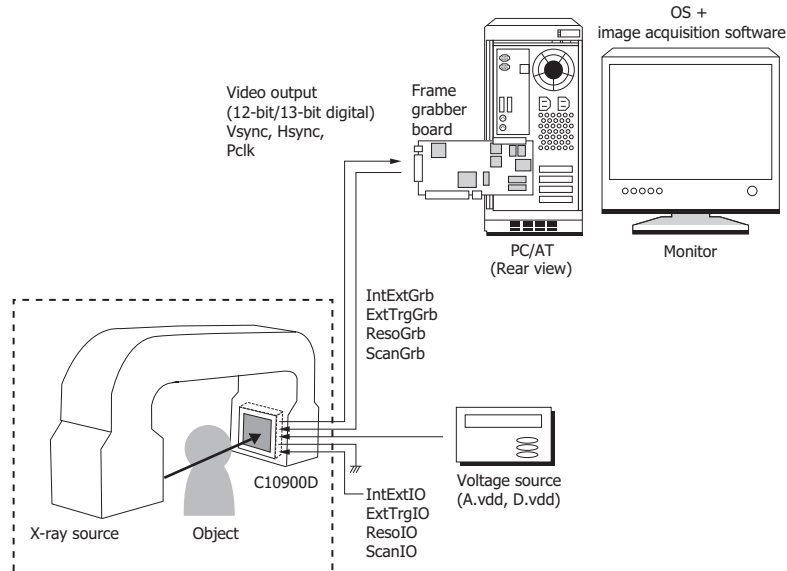

KACCC0482EA

Dimensional outline (unit: mm, tolerance: ±1 mm unless otherwise noted)

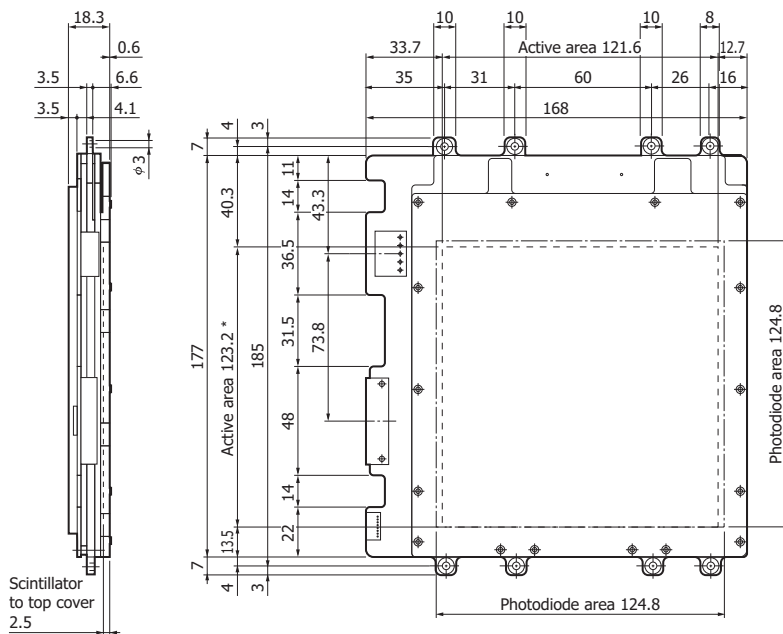

The cover is made of carbon fiber (0.4 mm thickness)
Weight: 1.2 kg

* Fast mode / Fine mode

KACCA0254ED

Description of terms (Fine mode)

☒ **Blemish**

Length of pixel cluster which has less than 90 % of the average sensitivity of the surrounding pixels.

☒ **Bright line output adjacent to a defect line**

The relative sensitivity ratio "a/b" should be 120 % or less for both vertical and horizontal lines, where "a" and "b" are defined as follows:

- a: Average sensitivity of bright line (Line A) adjacent to defect line
- b: Average sensitivity of standard line (Line B) adjacent to Line A

Note that the average sensitivity of the bright line is calculated from the region adjacent to the defect region in the defect line.

Example: See the right figure

Defect region in defect line: From pixel (J, 1) to pixel (J, 15)

- a: Average sensitivity from pixel (I, 1) to pixel (I, 15) or from pixel (K, 1) to pixel (K, 15)
- b: Average sensitivity from pixel (H, 1) to pixel (H, 15) or from pixel (L, 1) to pixel (L, 15)

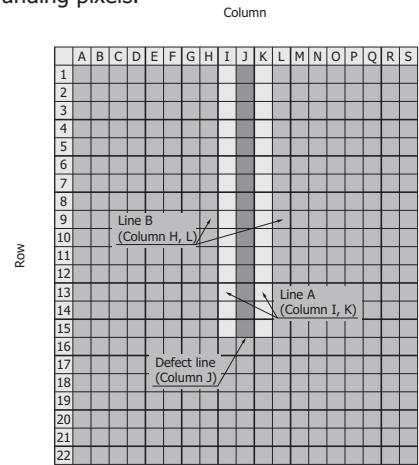

KACCC0385EB

☒ **Defect cluster**

Formed with more than 3 × 3 pixels which have less than 1/8 of the average sensitivity of the surrounding pixels.



This is defined as defect cluster. This is not defined as defect cluster.

□ Normal pixel ■ Defective pixel

KACCC0384EB

☒ **Non-uniformity of sensitivity**

16 × 16 segments are 16 × 16-divided active area excluded 1 mm from the whole edge. Xij is defined as the average sensitivity of each segment.

Uniformity of sensitivity is calculated as following equation.

$$\text{Non-uniformity of sensitivity} = \frac{\sigma}{\bar{x}}$$

σ: standard deviation of 16 × 16 "Xij"
 x̄: average value of 16 × 16 "Xij"

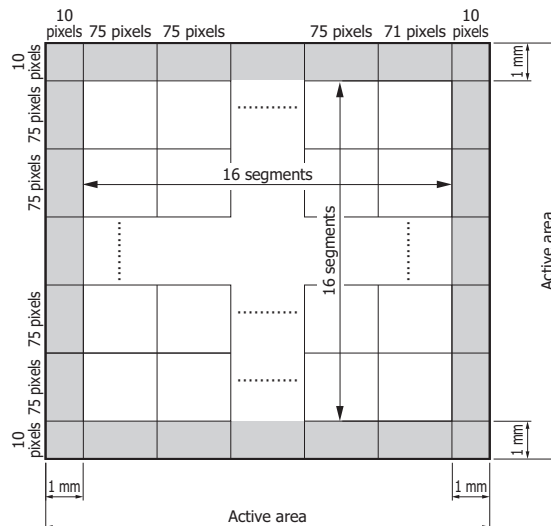

KACCC0407EA

Notice

- Do not subject the flat panel sensors to strong vibration or shock (Strong shock such as drop impacts may cause permanent damage to these sensors).
- Users must take responsibility for implementing X-ray shielding safety measures to avoid the risk of X-ray exposure.
- Data listed in this datasheet was measured at the time of shipment. Characteristics may vary somewhat due to exposure to X-rays so take proper countermeasures such as making periodic image correction.
- This product is warranted for a period of 12 months after the date of the shipment.
The warranty is limited to replacement or repair of any defective product due to defects in workmanship or materials used in manufacture. The warranty does not cover loss or damage caused by natural disaster, misuse (including modifications and any use not complying with the environment, application, usage and storage conditions described in this datasheet), or total radiation dose over 25000 Roentgen (incident X-ray energy: less than 90 kVp) even within the warranty period.
- This product is bare board type for installation into equipment and is not covered with a metal shielded case. When designing an equipment, implement EMC measures such as providing electromagnetic shielding on this product and the connection cables.

Information described in this material is current as of May, 2012.

Product specifications are subject to change without prior notice due to improvements or other reasons. Before assembly into final products, please contact us for the delivery specification sheet to check the latest information.

Type numbers of products listed in the delivery specification sheets or supplied as samples may have a suffix "(X)" which means preliminary specifications or a suffix "(Z)" which means developmental specifications.

The product warranty is valid for one year after delivery and is limited to product repair or replacement for defects discovered and reported to us within that one year period. However, even if within the warranty period we accept absolutely no liability for any loss caused by natural disasters or improper product use.

Copying or reprinting the contents described in this material in whole or in part is prohibited without our prior permission.

HAMAMATSUwww.hamamatsu.com

HAMAMATSU PHOTONICS K.K., Solid State Division

1126-1 Ichino-cho, Higashi-ku, Hamamatsu City, 435-8558 Japan, Telephone: (81) 53-434-3311, Fax: (81) 53-434-5184

U.S.A.: Hamamatsu Corporation: 360 Foothill Road, P.O.Box 6910, Bridgewater, N.J. 08807-0910, U.S.A., Telephone: (1) 908-231-0960, Fax: (1) 908-231-1218

Germany: Hamamatsu Photonics Deutschland GmbH: Arzbergerstr. 10, D-82211 Herrsching am Ammersee, Germany, Telephone: (49) 8152-375-0, Fax: (49) 8152-265-8

France: Hamamatsu Photonics France S.A.R.L.: 19, Rue du Saule Trapu, Parc du Moulin de Massy, 91882 Massy Cedex, France, Telephone: 33-(1) 69 53 71 00, Fax: 33-(1) 69 53 71 10

United Kingdom: Hamamatsu Photonics UK Limited: 2 Howard Court, 10 Tewin Road, Welwyn Garden City, Hertfordshire AL7 1BW, United Kingdom, Telephone: (44) 1707-294888, Fax: (44) 1707-325777

North Europe: Hamamatsu Photonics Norden AB: Thorshamnsgatan 35 16440 Kista, Sweden, Telephone: (46) 8-509-031-00, Fax: (46) 8-509-031-01

Italy: Hamamatsu Photonics Italia S.R.L.: Strada della Moia, 1 int. 6, 20020 Arese, (Milano), Italy, Telephone: (39) 02-935-81-733, Fax: (39) 02-935-81-741

China: Hamamatsu Photonics (China) Co., Ltd.: 1201 Tower B, Jiaming Center, No.27 Dongsanhuan Beilu, Chaoyang District, Beijing 100020, China, Telephone: (86) 10-6586-6006, Fax: (86) 10-6586-2866