



ACCESS CONTROL SOLUTIONS



iP-OPENER

**A different
way to
manage
your
security**



ABOUT US

Golmar is a Spanish brand with a global presence in international markets since 1954. A market leading company in the development and manufacture of video door entry systems and electronic security solutions. Golmar presents in this catalogue iP-Opener, an access control system manufactured in Europe, a connected solution that merges the potential and versatility of access control with the convenience and security of the video door entry system. Discover the different options we offer and the integration and connectivity solutions. Our values in security and quality come together in iP-Opener, a scalable, reliable and high performance system.

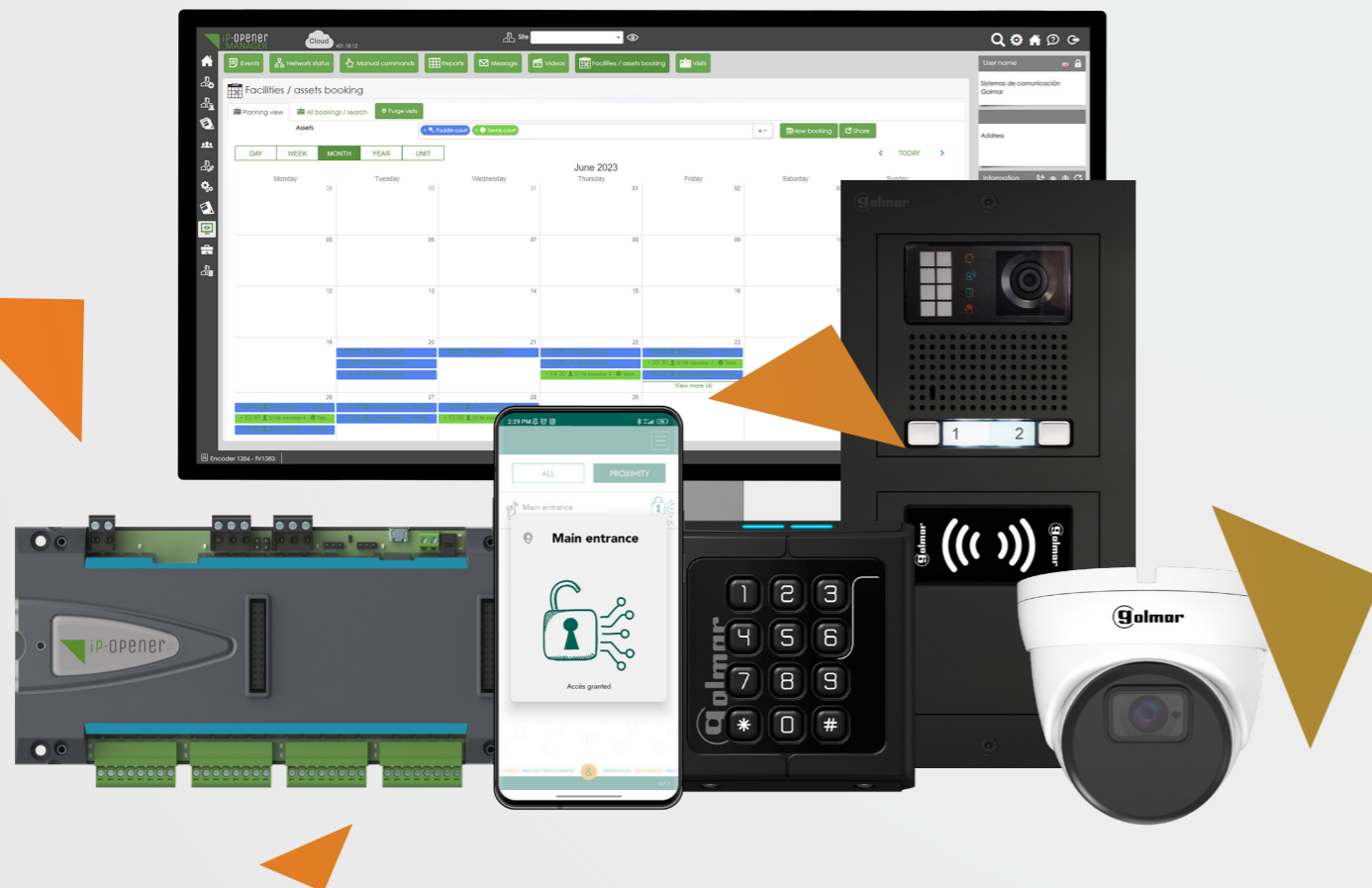

iP-Opener

Residential

iP-Opener perfectly fits on the residential projects, from building compounds to build to rent developments (BTR).



Healthcare

iP-Opener range will specially improve the security and the access control in the health sector, from elderly people residences to large hospitals.



Tertiary sector

Secure and manage the accesses in Industries, offices, students campuses and hospitality sector, restaurants and hotels.



Networked access control

IP-OPENER

iP-Opener is a scalable system that allows you to create installations of any size. Powerful and modular, it uses the latest encryption technology to allow you to secure your doors with efficiency and simplicity.

iP-Opener is a networked access control solution, which connects to a remote service in the cloud (www.ip-opener.com), that allows you to manage the site, obtain records and monitor all events in real time remotely. It is also possible to apply new settings, add credentials or modify permissions to groups of users as if you were logged in locally on the network. It features a booking service module, through the resident portal, making it possible to create areas where access is restricted, depending

on the occupancy and availability, such as gyms, paddle courts, sports areas... iP-Opener provides many functions for example: zones management, reflexes, anti-pass back, among others, which allow programming logics and routines that the site may require. The powerful management software enables these and more functionalities, that are programmed in a simple and intuitive way.

100.000
users per installation

20.000
events per controller

unlimited
number of networks

64
controllers per network

384
readers per network

Two ways of management:

Local

Conventional way of management, where software and database are installed on a **local network computer acting as a server**.

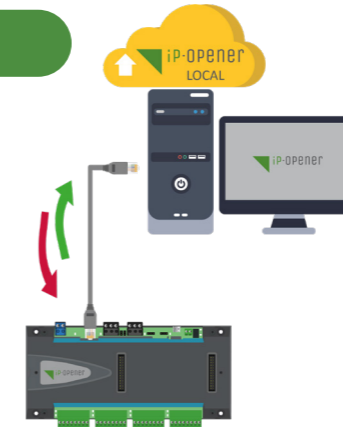

Cloud

The controller communicates with the **cloud server**.

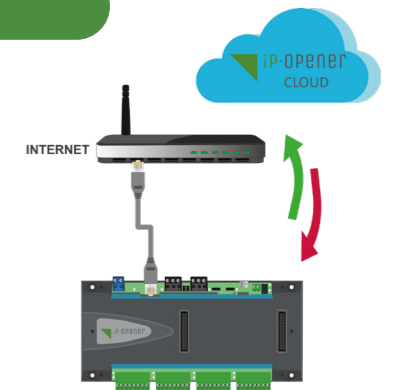

Cloud advantages



1. No software installation required
2. Always updated platform
3. Secured database and backup
4. Access from any location and device

Connection

The system supports different connection topologies: **UTP**, **RS485** and mixed (UTP + RS485)

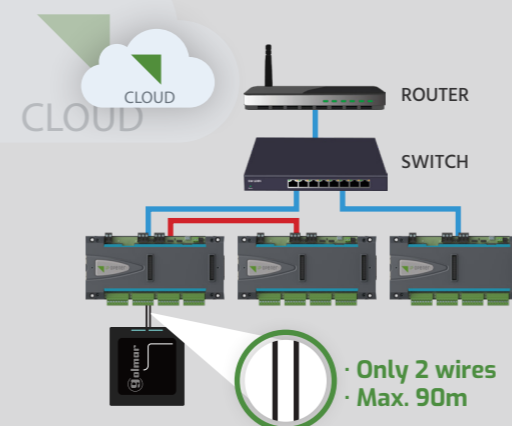

Multinetwork

Different networks in the same installation

Different sites can be managed in a centralized way from any location.

An ideal solution for companies with different offices that are located far away from each other.

Limitless number of networks, a scalable solution from the smallest to the largest site.

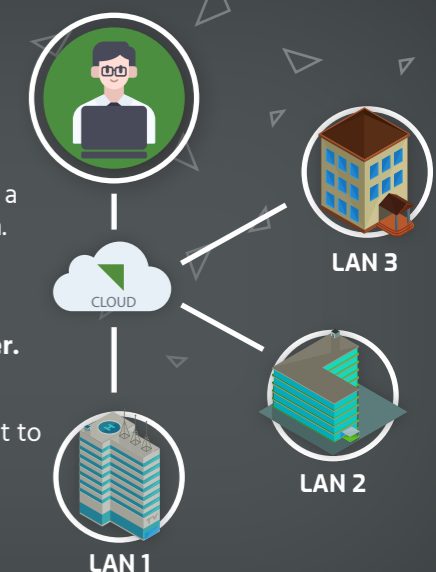

2 security at the highest level

2safe



The communication protocol of the 2SAFE technology increases the degree of security to unexpected levels. It only uses two wires in which the power supply and communication are transmitted in an encrypted way, giving no chance for the communication to be intercepted.

2SAFE supports AES (Advanced Encryption Standard). An encryption algorithm that is used in data communications to protect data from unauthorised access.

2SAFE security over two wires

Security is one of iP-Opener's greatest assets. Communications between the controllers and the various peripherals and readers are protected with the latest generation of encryption technology. The range of Mifare+ credentials, the radio frequency transmitter controls and the application via Bluetooth technology make copying and fraudulent access impossible thanks to proprietary encryption protocols such as Crypto-1 and AES-128.

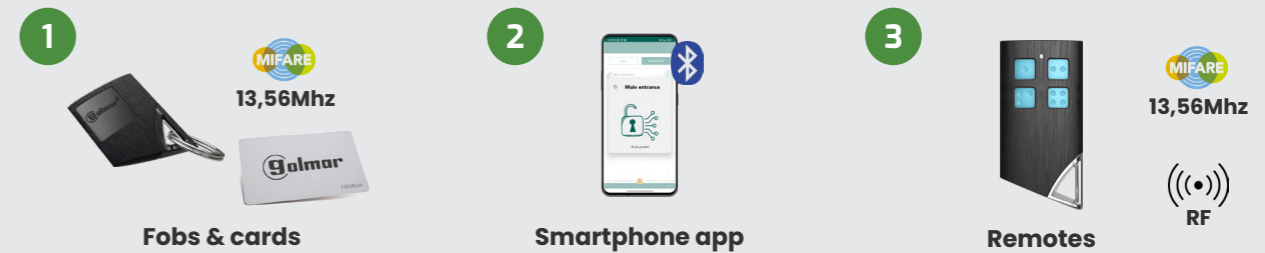
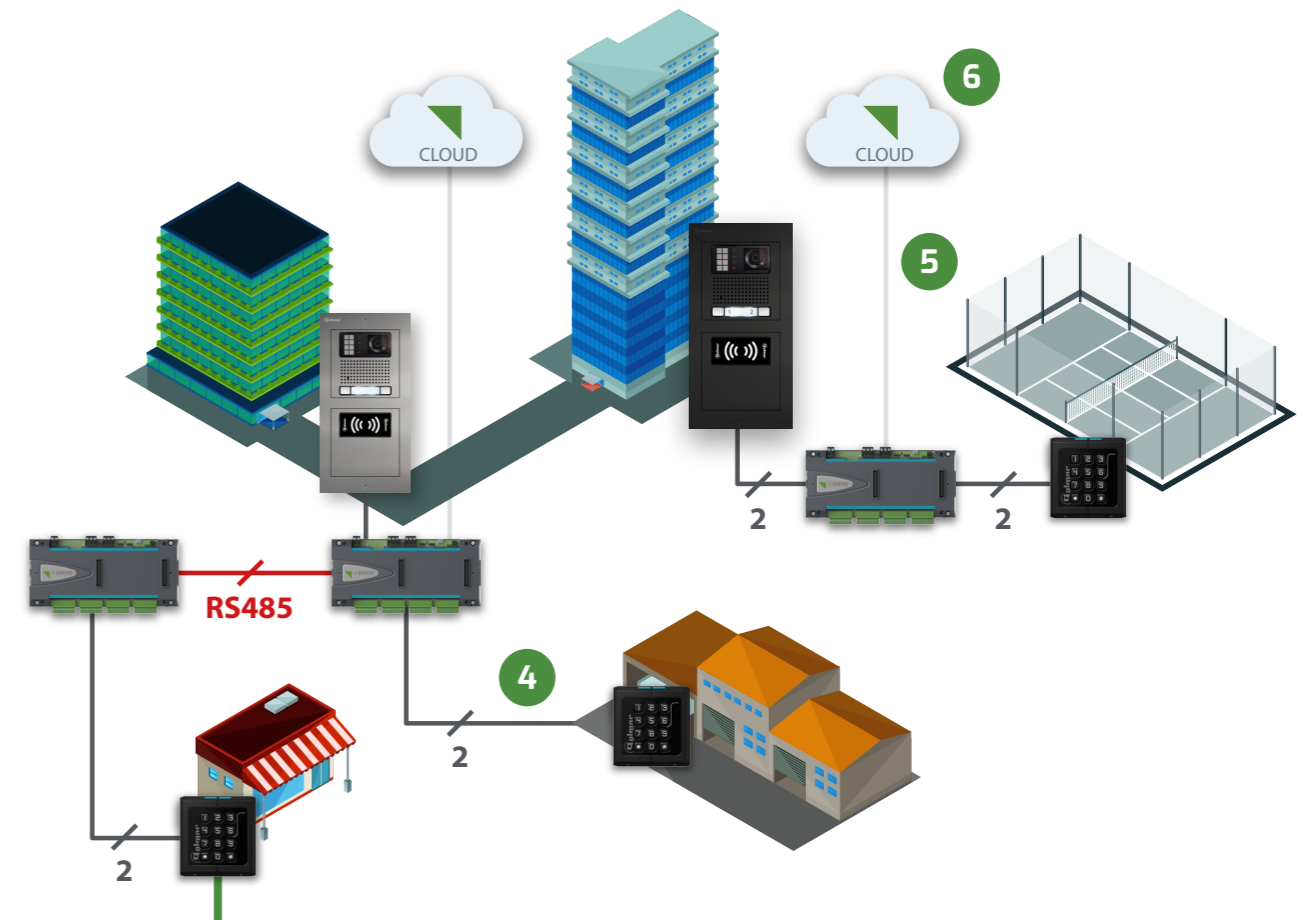

- 1 Crypto-1. AES-128 encryption
- 2 Crypto-1. AES-128 encryption
- 3 Radio Frequency own codification and communication
- 4 Own codification and communication
- 5 AES encryption supported
- 6 Protected by the latest software and tested frequently

RFID, Bluetooth & PIN code

2SAFE READERS & TOKENS

GM-IPOP



Multiple choices are available for 2SAFE readers depending on the needs. All 2SAFE readers are compatible with Mifare Classic and Mifare+ technology tokens as for use with thanks to the use of the application. **All readers connect to the iP-Opener and EASYGATE controllers with simply two wires.**

NETWORKED CONTROLLERS

EASYGATE

- Minicontroller for use with 2SAFE proximity readers.
- Programming and update through web environment (www.easygatecontroller.com), without a need for internet connection on site.
- 2SAFE wall readers using 2 wires connector.
- RFID verification.
- For the management of 1 door or access.
- Capacity for up to 2,000 users. Several readers can be combined in one site using the web environment.
- 12/24VAC or DC power supply (not included).

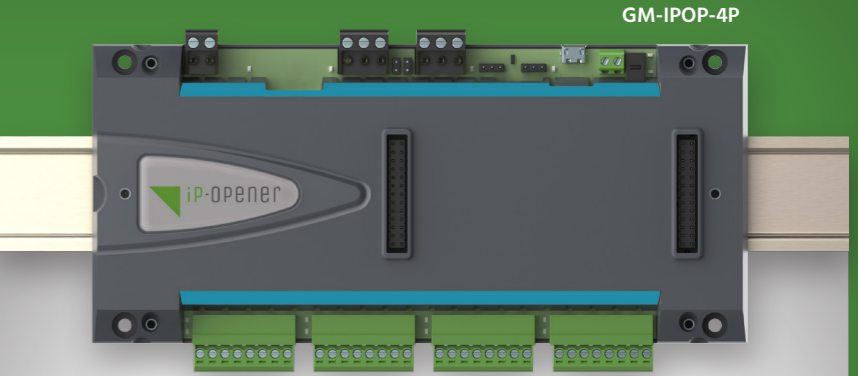

GM-IPOP

- Remote programming and management through the IP-OPENER MANAGER web environment or with a local PC as a server.
- 2SAFE wall readers using 2 wire connector: RFID, RF and BLE verification.
- Connection to LAN through TCP/IP or among different readers using an RS485 BUS.
- Available for 1, 2 and 4 doors expandable up to 6 doors with the expander GM-IPOP EXP2P.
- Capacity for up to 100,000 users and storage of up to 20,000 events.
- 48Vdc/2A output relays.
- Input for remote activation push button with optocoupler protection.
- DIN rail mounted, and protected with an enclosure with tamper alarm included.
- 12Vdc/1.5A power supply (PS included in the metal cabinets).

The smartphone as a key to access



BLE FUNCTION

iP-Opener offers the option to use the BLE feature of 2SAFE readers

To use the smartphone application as a token is simple. Download the app available in iOS and Android. The app account is linked to the phone number, so you'll never lose your credential again, instead, simply migrate it to another mobile phone.

There are multiple options, depending on the BLE POINTS added to the app. It can be used for a single use, 2 weeks use or permanent use. In the permanent activation of the app it might be used as a proximity fob or a remote, allowing the door to be opened from a distance and not needing to present your phone at the reader.



IP-OPENER MANAGER

A tailor-made software

www.ip-opener.com

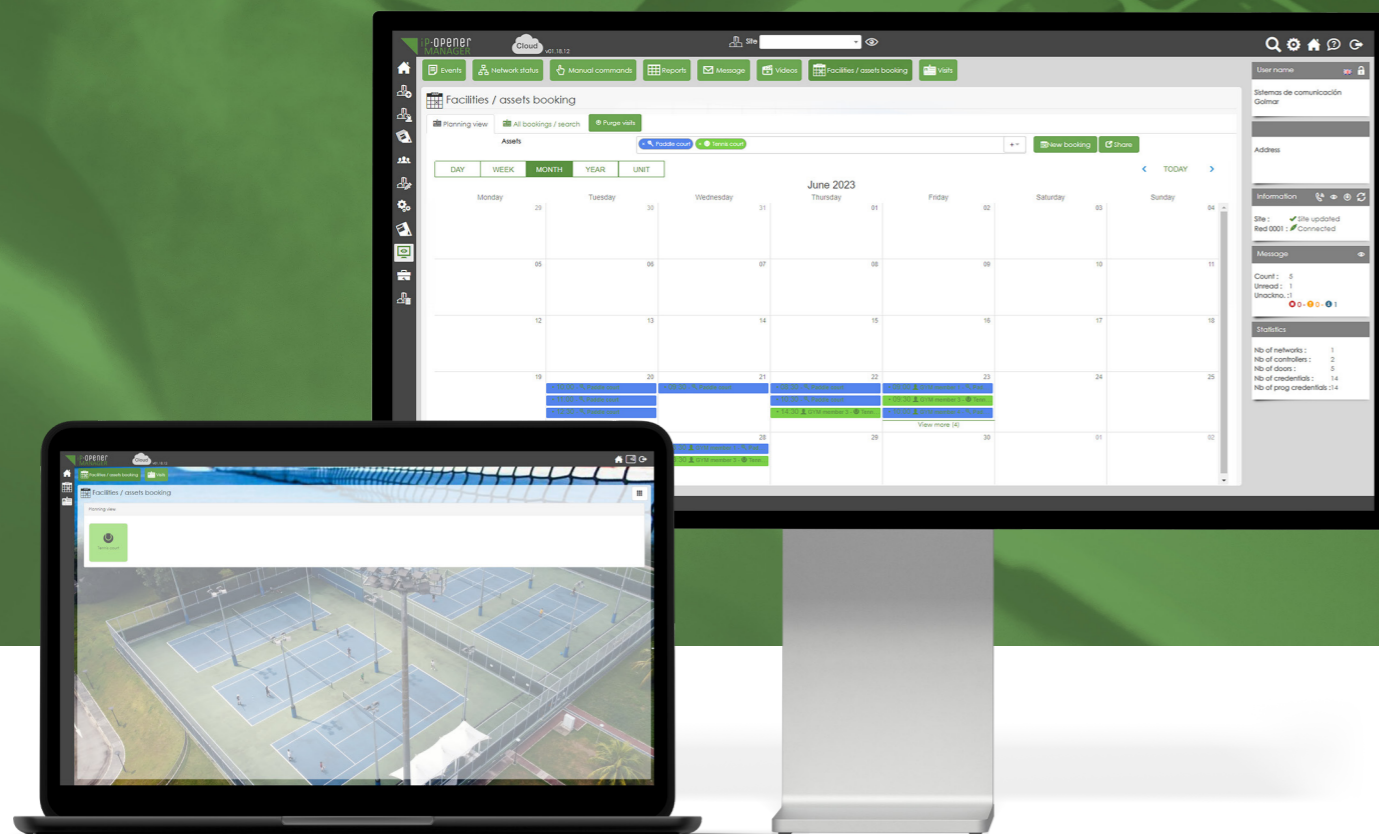

iP-Opener Manager is an innovative solution designed to meet the control and management needs of any type of installation. With its wide range of functionalities and options, this software allows users to have total control over their systems, giving them the ability to manage and monitor all aspects of their installation in an efficient and intuitive way.

Customisable Real time event monitoring

Stay up to date with what is happening in your facility at all times, and in the best way, by customising the alerts you wish to receive, as well as the appearance of these alerts. Any important event? Receive the alert by email.



Reports

Automatic generation of reports with the possibility of sending them periodically via email.



Reflexes

Automatic performance of an action when an event or different events take place in the system.

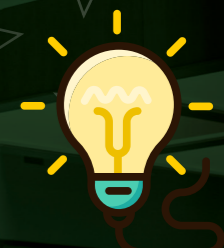

Multi-access to the software

Possibility to define who can access and which functionalities they can use.



Visitor management

Granting a temporary access

Ideal function for visitor management in companies as well as for holiday accommodation management or built-to-rent projects.

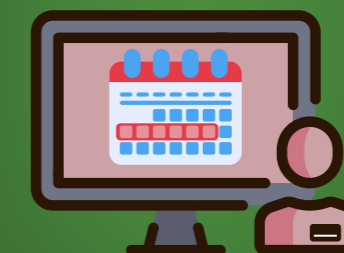

Booking management

Feature for the booking management of the facility's sites: meeting rooms, tennis courts, conference rooms...

Booking can be managed by the administrator or by the resident through the user portal.

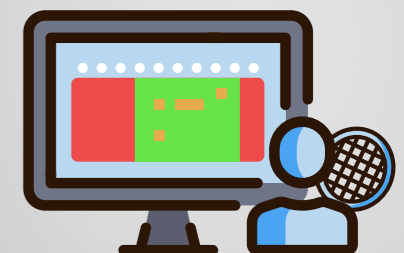

IP-OPENER INTEGRATION

The integration between the door entry system and the access control is one of the most advantageous added values. Empower the video door entry system with the most advanced and secure access control technology.

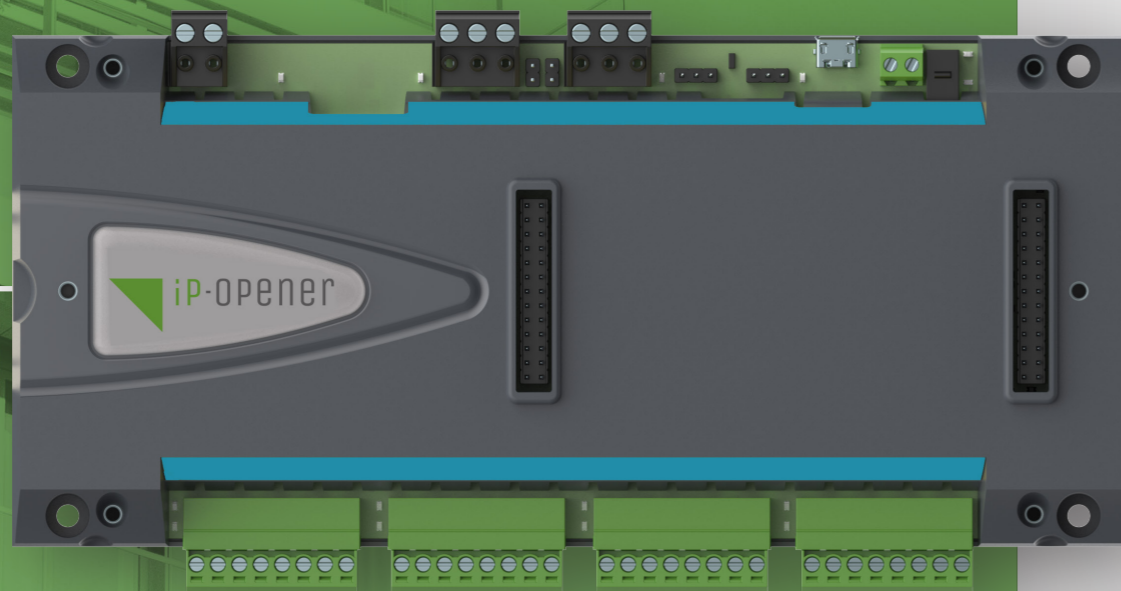

It is possible to integrate the door entry system with the access control, thanks to the Golmar door entry panels and antenna modules, specially adapted for the Golmar video intercom panels. Secure all data thanks to the **2SAFE encrypted transmission protocol** and upgrade the access control feature of the door entry panel as an integrated device inside iP-Opener Manager.

Just 2 wires are needed for communication between the door entry panel built-in antenna and the controller.

Secure the door and access thanks to iP-Opener, integrate it with the intercom 2 wires BUS G2+ or IP G+ network, thanks to the relays SAR-G2+ and SAR-G+ connected to iP-Opener.

Intercom door panel materials

Front made of 2mm thick AISI 316 stainless steel, and a camera visor made of high resistance polycarbonate



Open door confirmation

2SAFE panel reader
EL4500/2SAFE

13,56 MHz encrypted communication and BLE function



2SAFE reader for custom panels
GM-IPOP SQ40

13,56 MHz encrypted communication and BLE function
40(W) x 40(H) mm





CCTV

iP-Opener can link to Golmar CCTV cameras to the management software.

The cameras can be associated to a door, allowing you to view the images of the access and to verify that the access was made by the corresponding person.

Integrate the iP-Opener with Number Plate Recognition cameras (NPR) for the vehicular accesses.

Lifts

Limited access to certain floors of the building is possible by using the GM-IPOP-10S-RS485 module or GM-IPOP-EXP12S output expander. This will enable or not the access depending on the permissions granted to the user.









Alarms

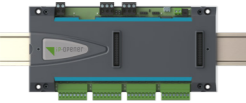
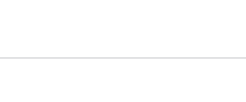
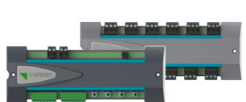

The GM-IPOP-EXP12E input expander enables the connection of the system with fire alarm control panels as well as stand-alone alarm detectors.

Detections can be monitored in iP-Opener Manager, reported via email or set actions to be taken after detection such as free access in case of fire.



CONTROLLERS

	GM-IPOP 1P 20780200	1 door controller
	GM-IPOP 2P 20780201	2 doors controller *Also available in Wiegand protocol
	GM-IPOP 4P 20780202	4 doors controller
	GM-IPOP-EXP2P 20780211	2 door expander
	GM-IPOP-EXP12E 20780213	12-input expander
	GM-IPOP-EXP12S 20780212	12-relay expander
	GM-IPOP-10S-RS485 20730004	10-relay outputs module
	EASYGATE 20740440	1 door controller

2SAFE WALL-MOUNT READERS



	GM-IPOP 40 20720004	Wall-mounted reader • 13,56 MHz and BLE
	GM-IPOP 80 20720005	Wall-mounted reader • 13,56 MHz and BLE
	GM-IPOP 80D 20720006	Wall-mounted reader • 13,56 MHz and BLE

RADIO FREQUENCY (RF)



	GM-WRIPOP 20780209	Receiver interface • RF receiver interface on BUS • 868 MHz working frequency • 100m distance in open field • Input for inductive loop (loop input)
	GM-WEIPOP 20780210	Transmitter controls • 4 buttons transmitter • RF transmitter and RFID (13,56 Mhz)

PROXIMITY TAGS



13,56 MHz MIFARE CLASSIC

	ISOPROX 20750500	Proximity card • Crypto-1 • Sales unit: 6 pcs.
	KEYPROX 20760400	Proximity fob • Crypto-1 • Sales unit: 20 pcs.

13,56 MHz MIFARE PLUS - Guarantees the anti-copying or cloning of the credentials

	CARDDOOR MF+ 20710009	Proximity card • Crypto-1 AES-128 • Sales unit: 10 pcs.
	TAGDOOR MF + 20780208	Proximity fob • Crypto-1 AES-128 • Sales unit: 20 pcs.
	PULDOOR MF + 20710001	Identification wristband • Special for sports activities • Crypto-1 AES-128 • Sales unit: 100 pcs.

APP | Bluetooth

BLE POINTS
20710510

Points for the use of the BLE function

- Allows the user to access via smartphone (requires application available on Android and IOS).
- Minimum quantity of sale: 50 points

USE	BLE POINTS
1 day of use	1 point
2 weeks of use	2 points
Short distance - Permanent use	5 points
Long distance - Permanent use	20 points

Programming

	GM-USBIPOP	Desktop programmer for iP-Opener and EasyGate control panels • USB card and key fob programmer • For MIFARE CLASSIC and MIFARE PLUS credentials • Encoding to PC via USB port
---	-------------------	--



www.golmar.es