

Key Stonework Ltd

Architectural Stonework Solutions

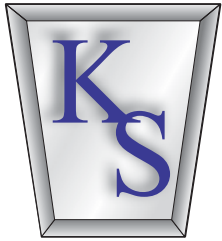

*“Quality you
can count on”*



Contents

Cill	3
Heads	4 & 5
Keystones & Corbels	6
Quoins	7
Strings & Plinths	8
Wall Copings	9
Pier Caps	10 & 11
Porticos	12 & 13
Balustrading	14 & 15
Architectural Features	16 & 17
Ornamental Features	18
Natural Stone	19
Our Services	20
Project Portfolio	21 & 22
Technical Information	23



Window Cills

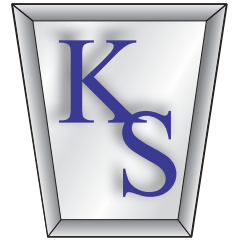

Section

Plan View

Stooled Cill
Type C1

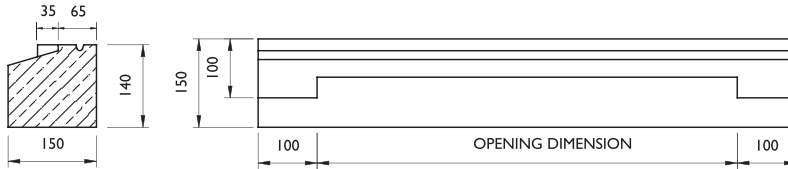

Bullnosed
Stooled Cill
Type C2

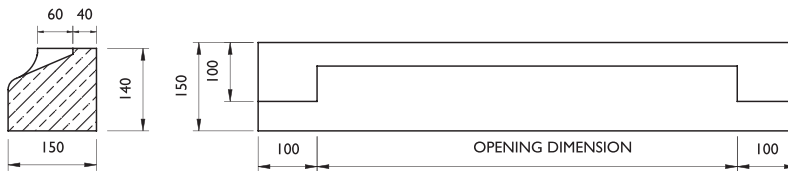

Slip Cill
Type C3

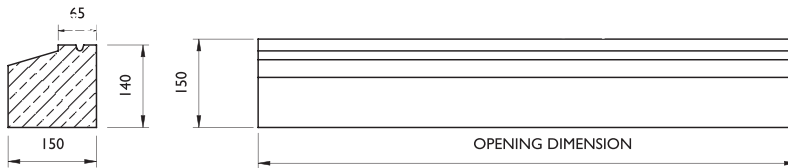

Stooled Cill
Type C4

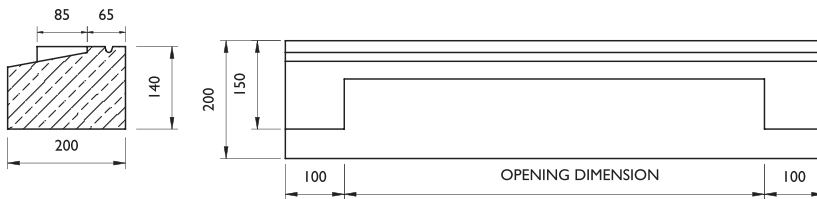

C1 Cill & H5 Head

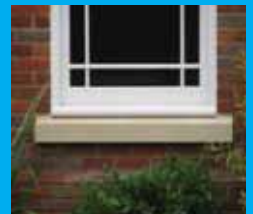

C1 Cill



C2 Bullnosed Cill



C3 Cill & H1 Head



Cills exceeding 1500mm long will be manufactured in more than one piece.

Stooled cills should only be bedded under each end at the time of installation, the joint below should be left open and pointed up at a later date.

Slip cills should be fully bedded down on mortar.

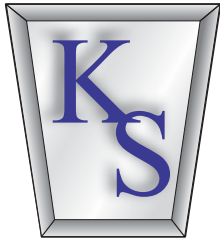

Window Heads

Elevation

Section

Type H1

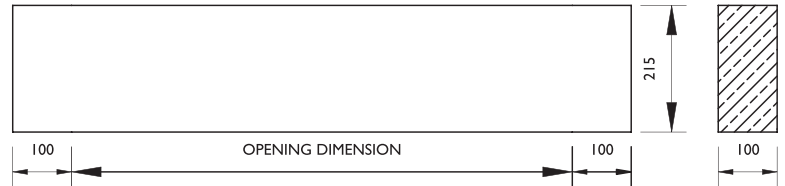

Plain Head
Type H2

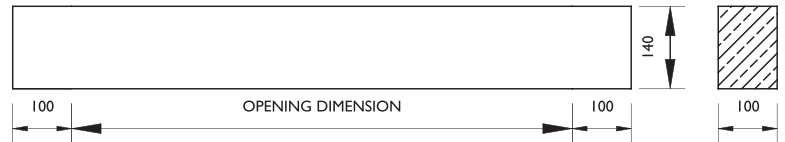

Plain Head
Type H3

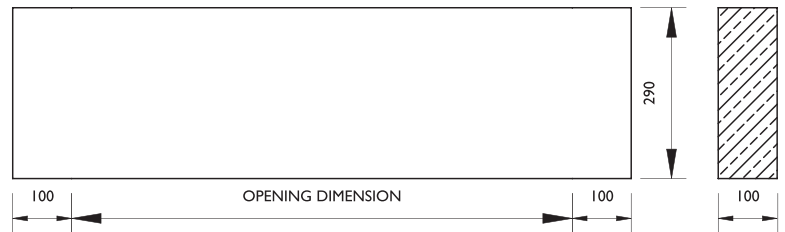

Tapered
Head
Type H4

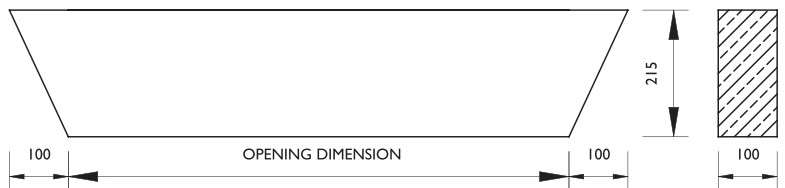

Tapered
Head
Type H5

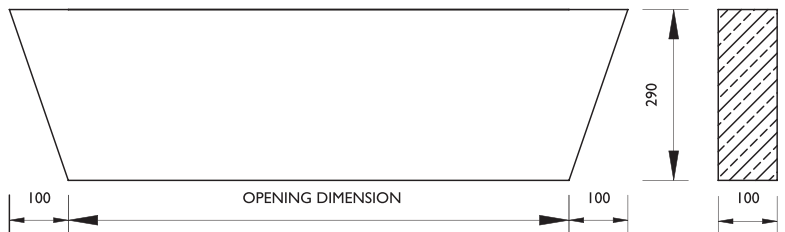

H5 Head & C1 Cill



H1 Head & C3 Cill



H1 Head & C3 Cill



H5 Head

All Window Heads are non-structural

Heads exceeding 1500mm long will be manufactured in more than one piece

Window Heads

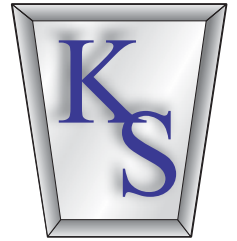

Section

Elevation

Plain Head & Keystone Type H6

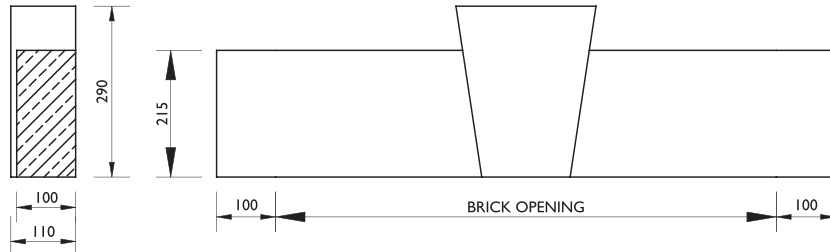

Tapered Head & Keystone Type H7

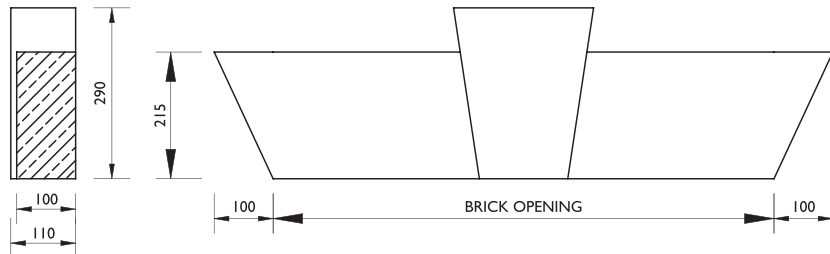

Chamfered Head Type H8

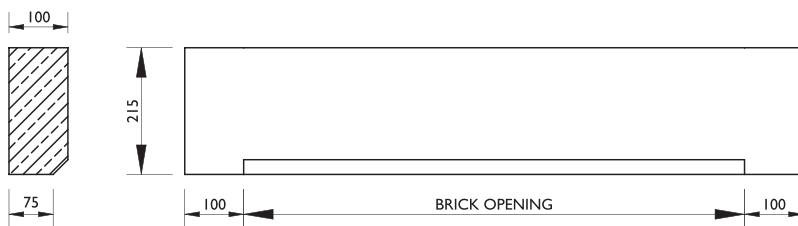

Moulded Head Type H9

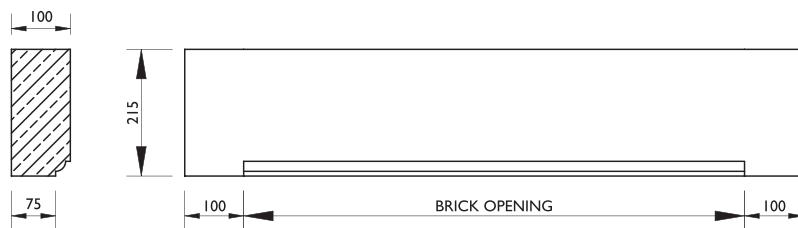

H4 Head



H4 Head & Special Cill



H8 Chamfered Head



H8 Chamfered Head & Cill



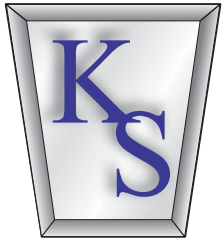

Keystone & Corbels

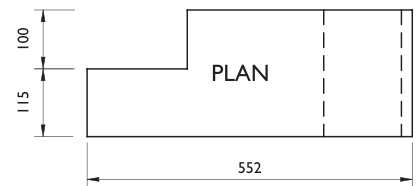
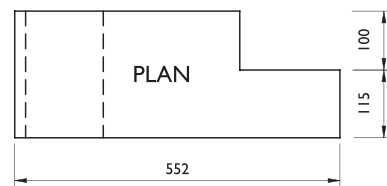
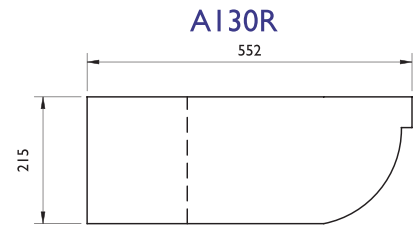
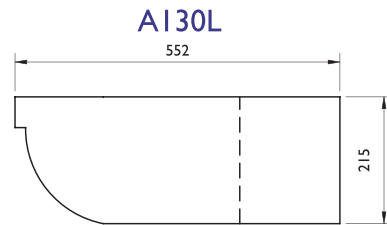
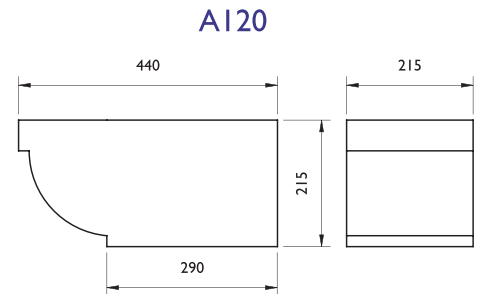
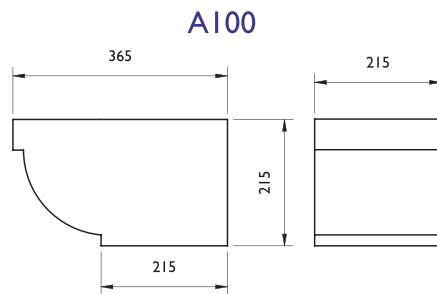
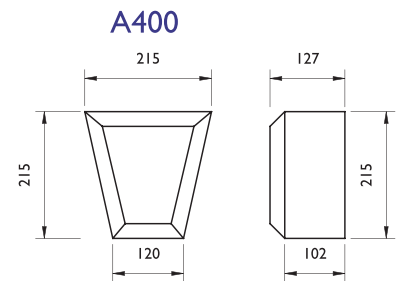
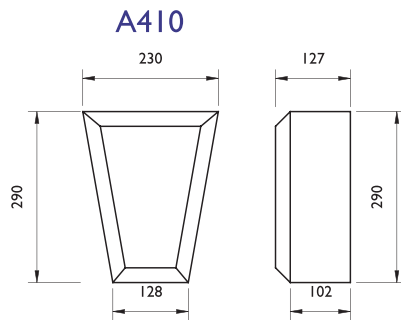
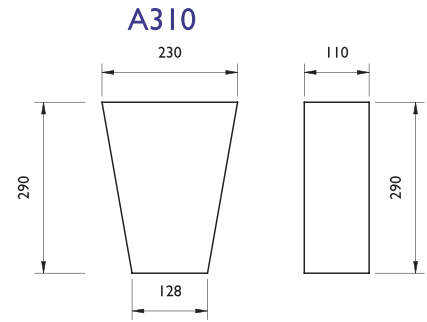
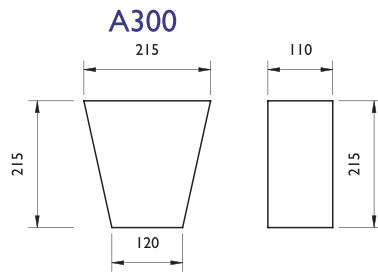

Quoins

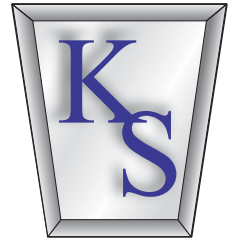

Q200

3-Course Plain Quoin

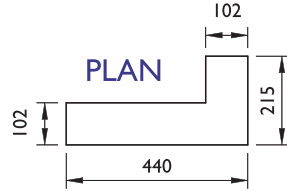
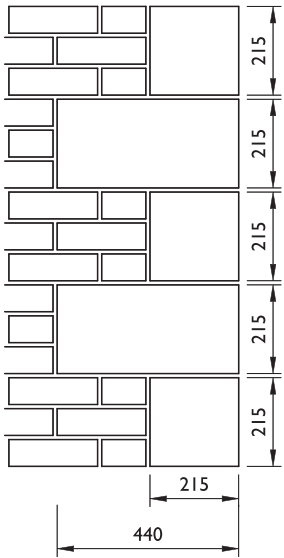

Q300

4-Course Plain Quoin

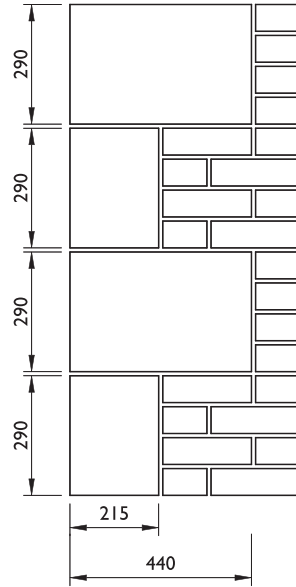

Q400

3-Course Chamfered Quoin

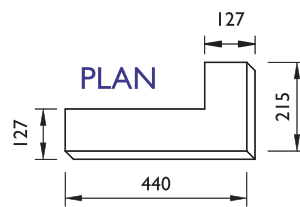
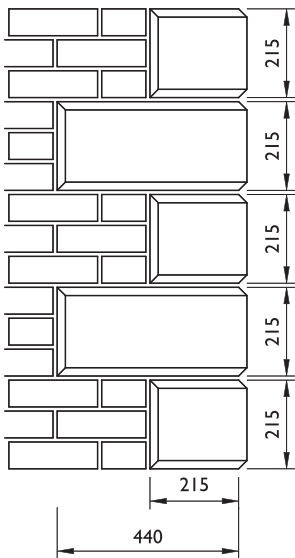

Q500

4-Course Chamfered Quoin

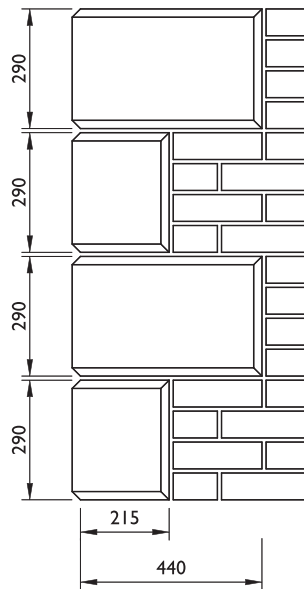

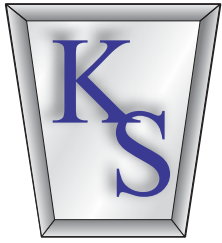

Strings & Plinths

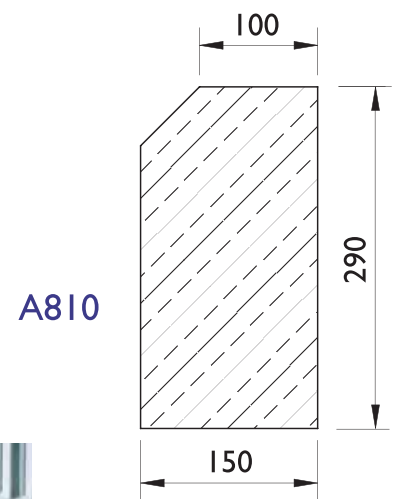
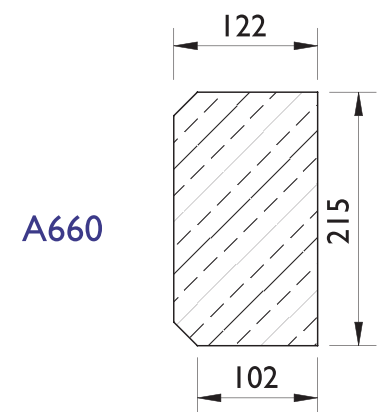
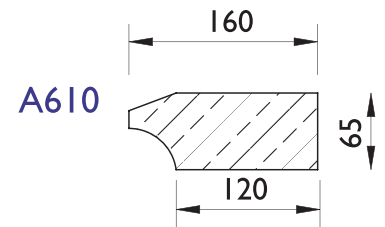
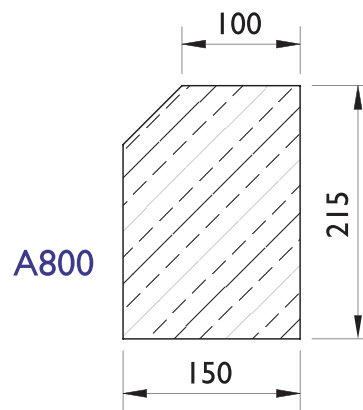
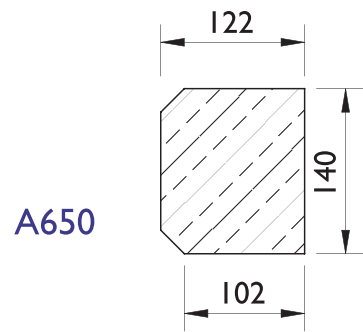
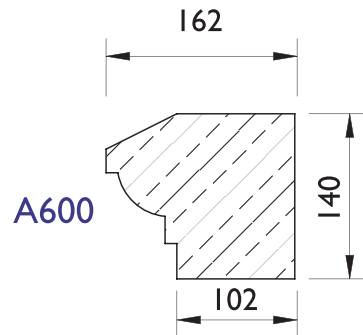

Wall Copings

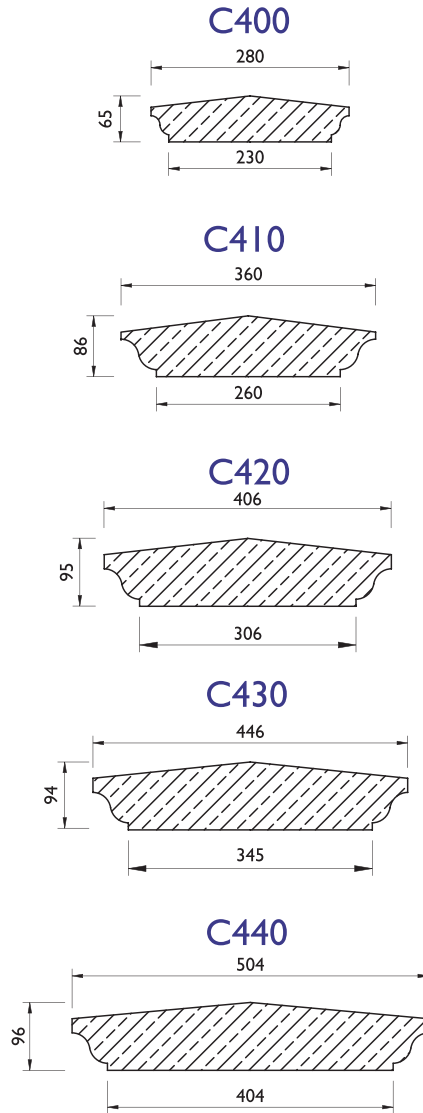
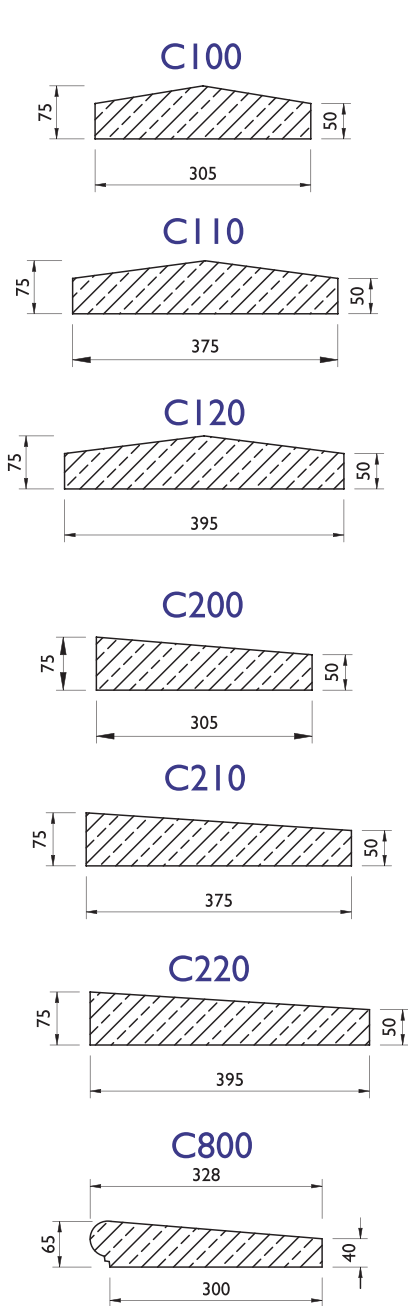
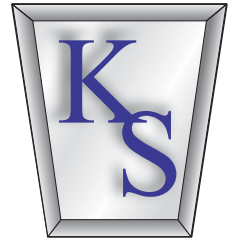

Pool Coping

All copings are manufactured with a drip groove.



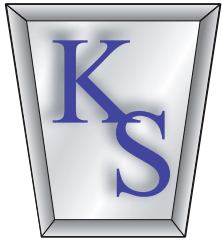

Pier Caps

PC215

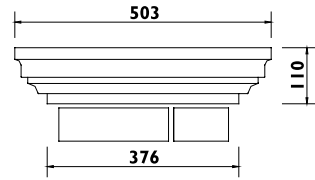

PC255

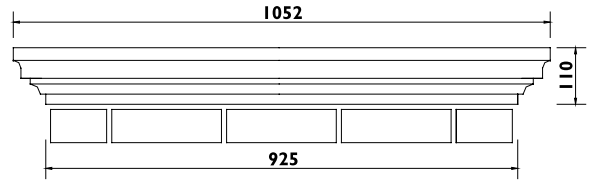

PC225

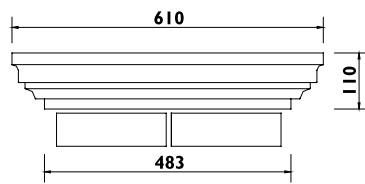

PC315

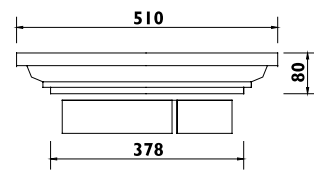

PC235

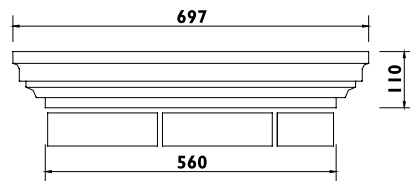

PC325

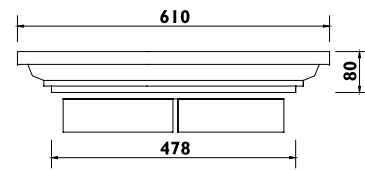

PC245

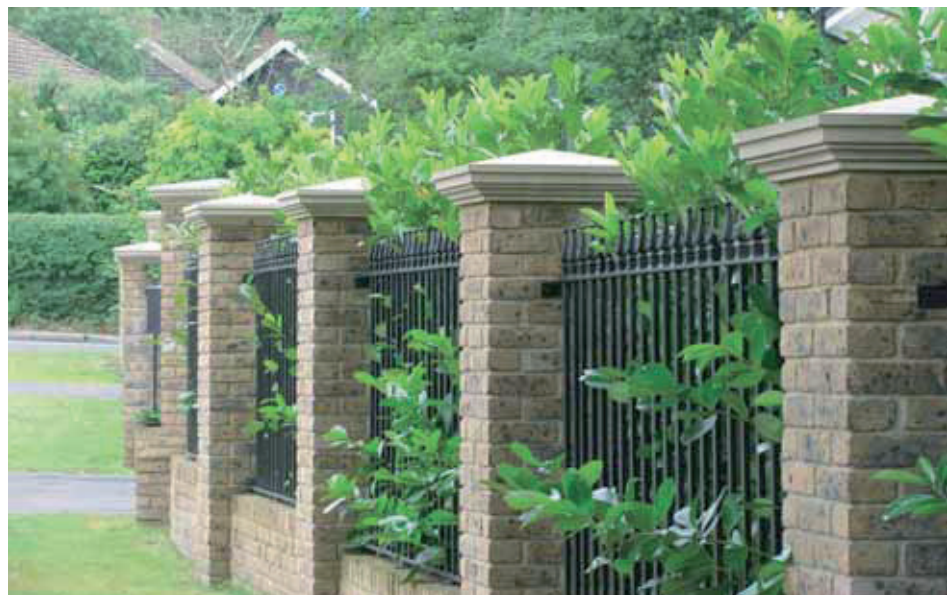
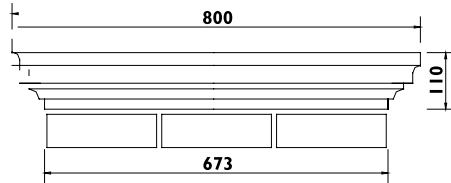

Pier Caps

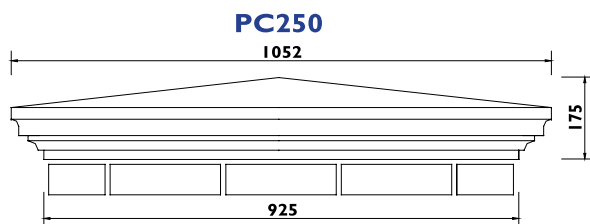
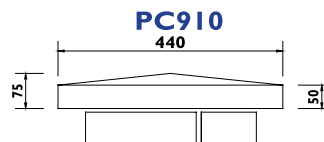
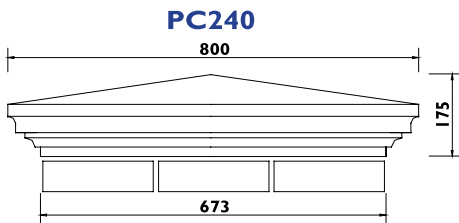
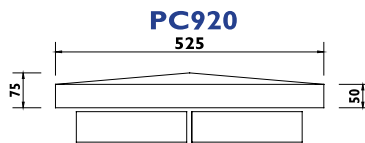
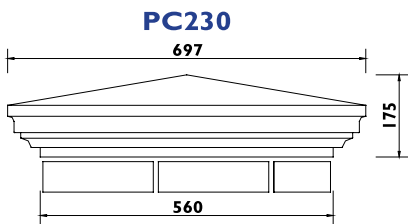
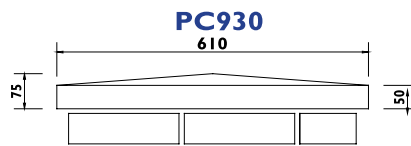
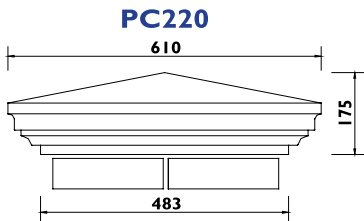
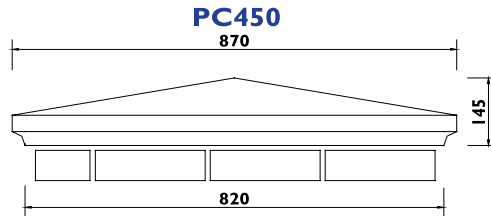
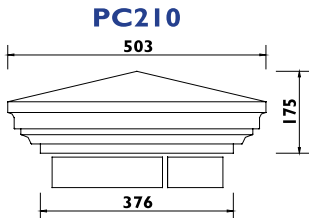
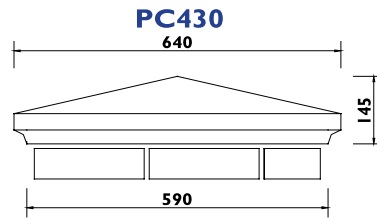
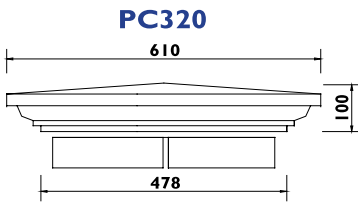
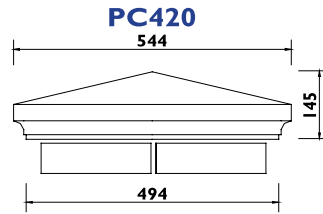
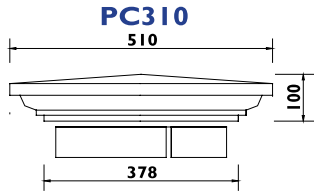
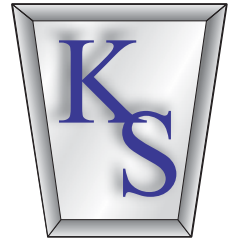

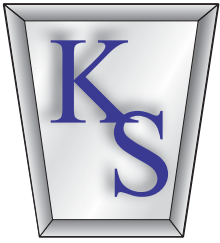

Porticos

Type A Portico

Utilising C200 Columns

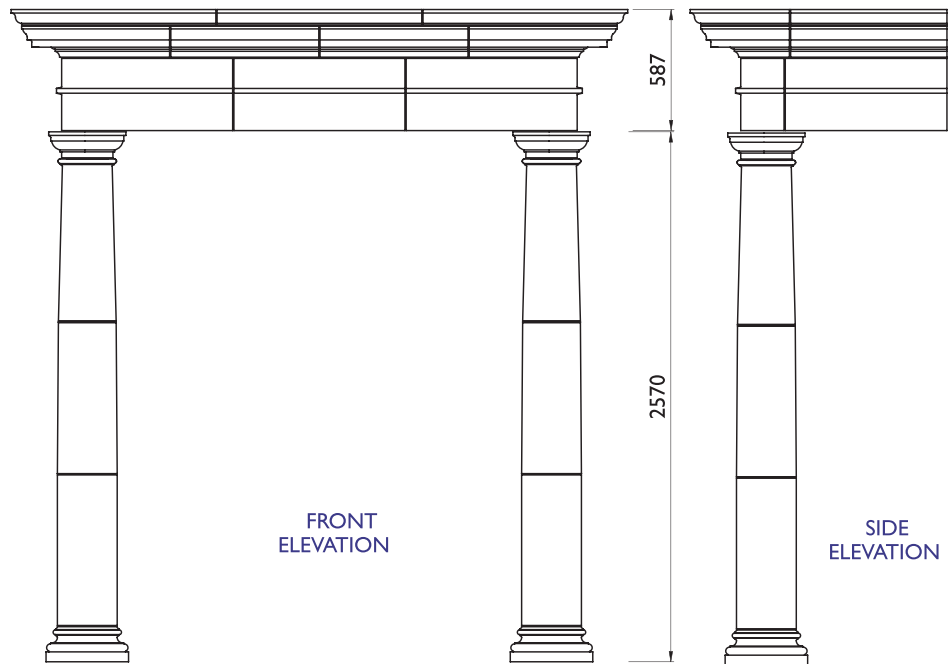

Type B Portico

Utilising C100 Columns

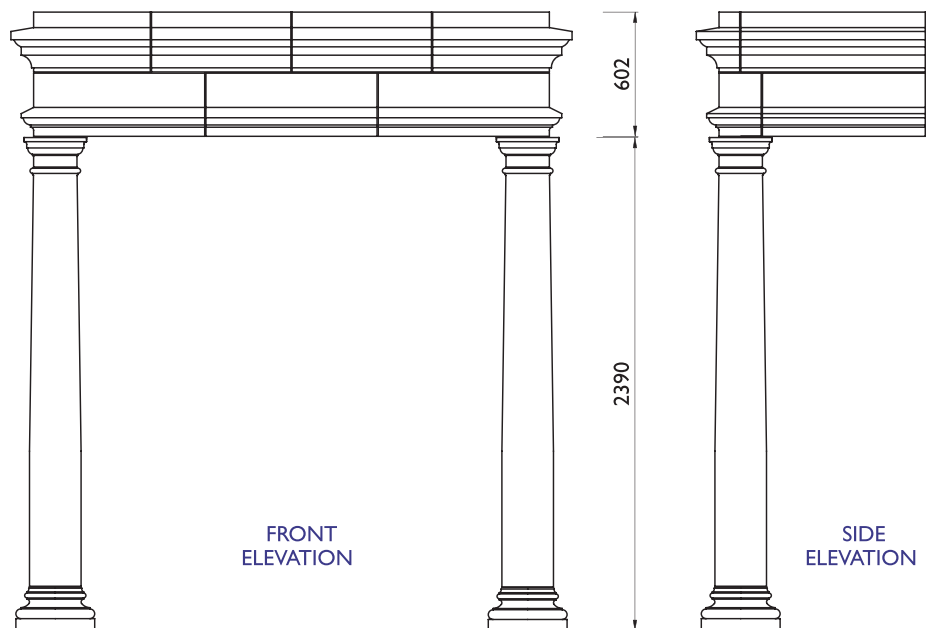

Porticos are manufactured to individual requirements - telephone for details.

Porticos

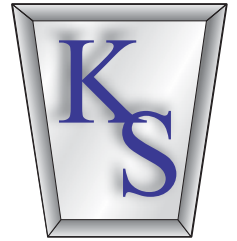

Type C Portico

Utilising C300 Columns

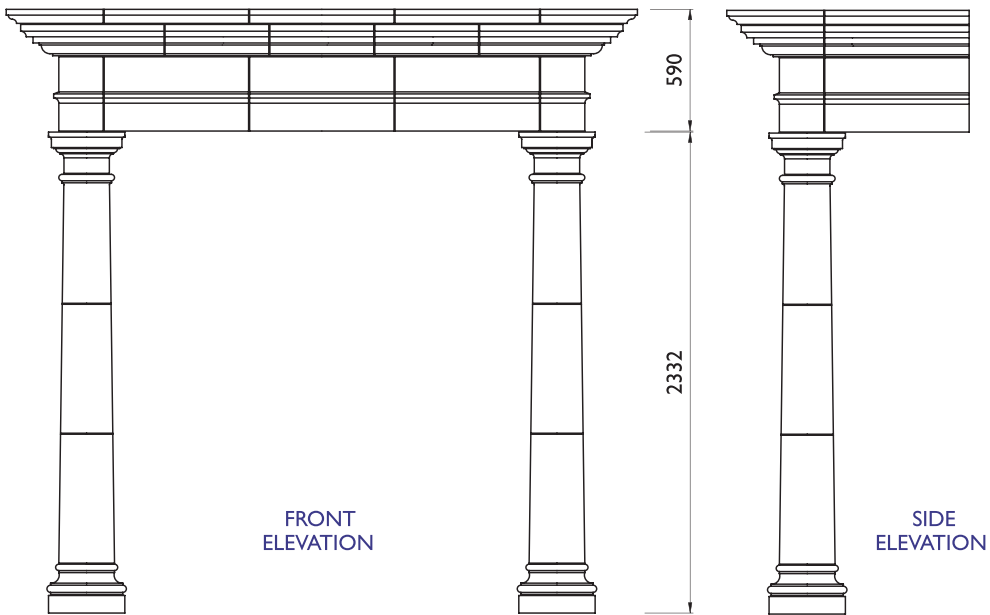

Type A Entablature Section

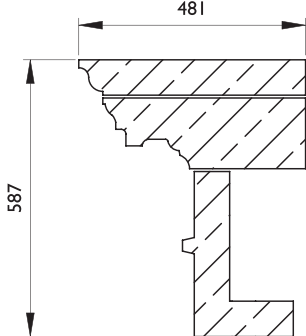

Type B Entablature Section

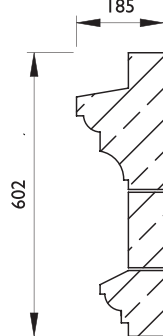

Type C Entablature Section

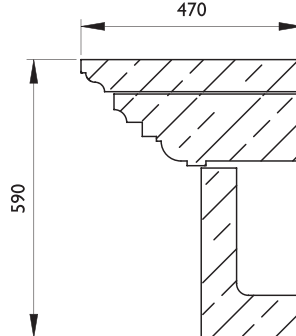

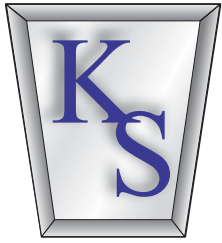

Balustrading

Standard Balustrading

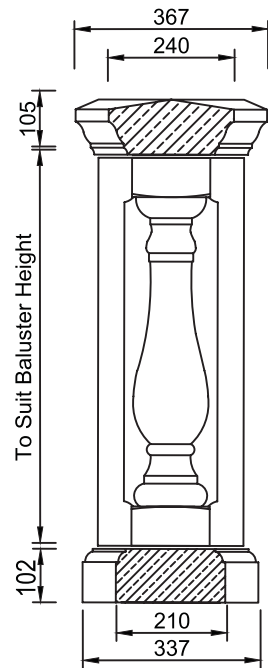

Standard Pier

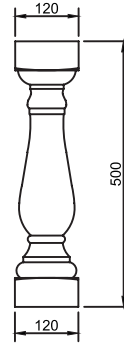

B500G

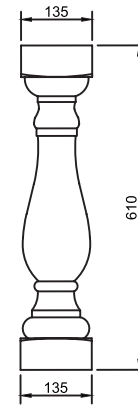

B610G

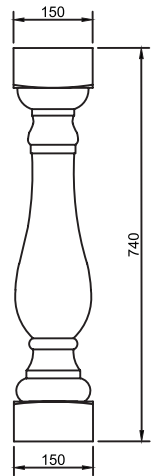

B740G



Balustrading

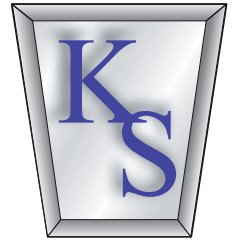

Pier Layouts

Part Weathered Central Run-In

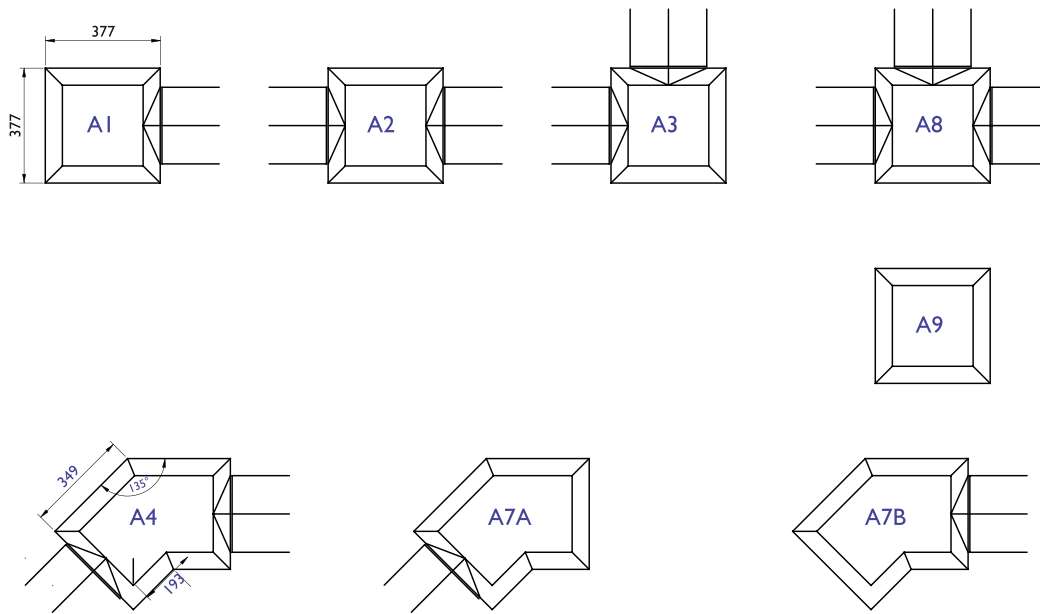

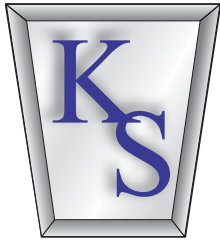

Architectural Features

Step Treads & Risers

Our standard Treads are available in either a bull nose or a square edge style as shown.

Both styles can be manufactured up to a maximum length of 1000mm long and a maximum width of 450mm.

Riser heights can be made to suit. Key Stonework's steps need to be continuously bedded.

All our treads & risers are made in our Wet-Cast material



Square Edged Step Treads

Bull Nosed Step Treads



B400 Ball & Collared Base



B300 Ball & Collared Base



B225 Ball & Collared Base

Balls & Bases

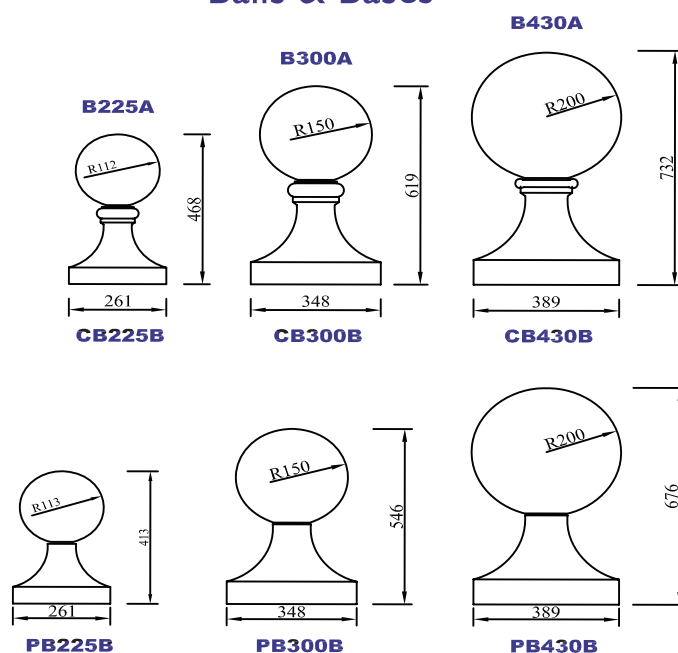

Architectural Features

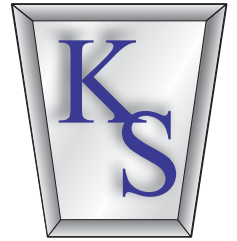

Gable Vents

GVI

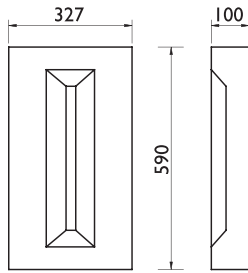

GV2

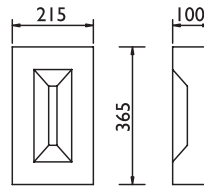

Date Plaques

P100

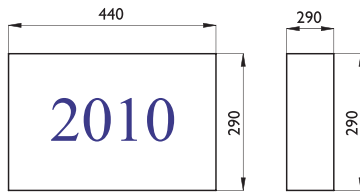

P120

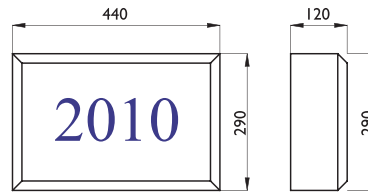

P200

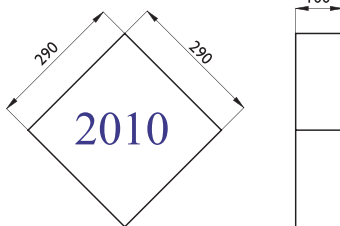

P220

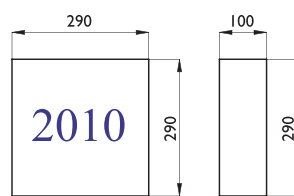

P300

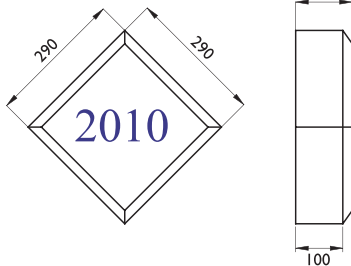

P330

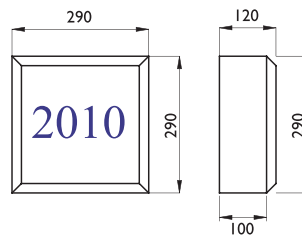

Date Plaques can also be manufactured to particular customer requirements



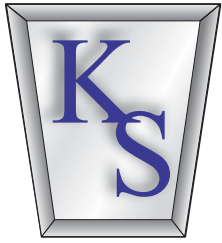

Ornamental Features



Clarence Urn



Regency Urn



Gothic Urn



Large Elizabethan



Gothic Vase



Medium Pool Surround, 2705mm Internal Diameter



Large Pool Surround, 3660mm Internal Diameter



Extra Large Pool Surround (without vases), 5450mm Internal Diameter



52" Curved Seat



Eton College Fountain



Extra Extra Large Pool Surround (without vases), 7500mm Internal Diameter

More Ornamental Designs Can Be Viewed On Our Website

Natural Stone

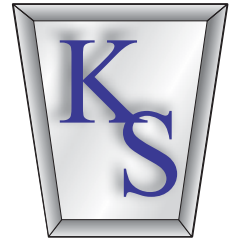

To compliment the Architectural and Ornamental cast stonework we can now offer Natural Stone.

It could be that you are bound by planning constraints, or, that you want to use something a little extra special.

Whatever your reason we are now able to provide most types of Natural Stone.

Our range is not limited to Treads and Paving, all manner of features can be created, from Copings, Cornices, Window Heads and Cills, to Balustrade and Ornaments.



The most popular variants we supply are, Portland (limestone), Bath (sandstone) & York Stone, however, should you have a specific requirement please contact us for further information.

Please note when choosing Natural Stone product colour variation can occur.

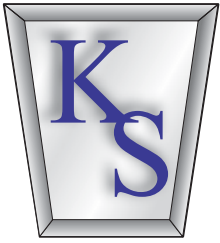

Our Services

Wet-Cast

Key Stonework Wet-Cast architectural cast stone is an extremely durable, high strength material with cube strengths typically exceeding 40N/mm².

Key Stonework Wet-Cast is available in our standard Portland and Bath colours, special colours are available on request.

Key Stonework Wet-Cast components have a higher resistance to abrasion and impact damage, which makes them less susceptible to damage, for this reason all our step treads are manufactured from this material.

Along with manufacturing a wide range of our standard products in Wet-Cast we can also provide a fully bespoke service.

Stonework Installation

Key Stonefix Ltd has been set up to provide an expert stone installation service for Key Stonework's customers.

Our operatives have many years experience installing reconstructed and natural stone products from step treads to portico's and balustrading.

By using Key Stonefix Ltd you will get the peace of mind that comes with a quality stone installation.

Key Stonefix Ltd is able to provide a supply and fix, or fix only service.

Please contact 07800 880 459 for further information.



Project Portfolio

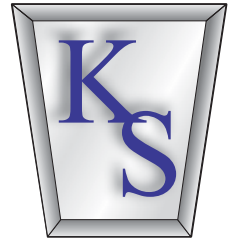

Private Residence in Surrey, utilizing standard Chamfered Quoins, Window Cills, Balusters, Sep Treads and Portico components, alongside bespoke curved Architrave and Cornice to rear bays (DCM).

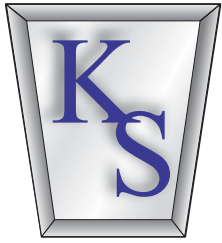

Project Portfolio



Standard Portico Type B & C4 Stooled Cills in Bath Colour. (DCM)



Standard H1 Window Heads with C3 Slip Cills, C220 Once Weathered Coping including Vertical Curve and Special Structural Front Door Lintol. (DCM)



Standard Type C Entablature with Type C400 Columns and Cladding to Rear, C3 Slip Cills and Plain String Course. (DCM)



Standard A810 Chamfered Plinth Course, C1 Stooled Cills and GV1 Gable Vents. (WCM)



Square Columns with Pedimented Portico produced from Type C Entablature, H1 Window Heads and C1 Stooled Cills. (WCM)



Square Columns with Type C Entablature, A800 Plinth Course, H1 Window Heads, C1 Cills and GV1 Gable Vents. (WCM)

DCM = Dry- Cast Reconstructed Stone
WCM = Wet-Cast Reconstructed Stone

Technical Information

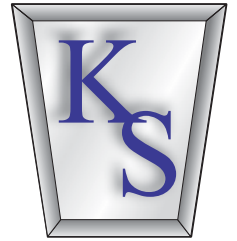

Standards

Key Stonework Architectural Cast Stone is manufactured to BS 1217: 1997

Manufacturing Tolerances

Dimensional tolerances permitted by BS 1217: 1997

Dimension (mm)	Tolerance (mm)
Up to 600	+/- 2
601 to 1000	+/- 3
1001 to 2500	+/- 4
2501 to 4000	+/- 5
Over 4000	+/- 5

Mortar Recommendations

Masonry cement/sand and plasticised cement/sand mortars are suitable for use with Key Stonework Cast Stone, however, mortars containing lime are highly recommended as they have a lower permeability and give greater resistance to rain penetration. Mortars must be able to resist frost and develop durability quickly, however, unnecessarily strong mortars should be avoided as they concentrate the effect of any differential movement.

Handling and Storage

Key Stonework Cast Stone is supplied banded and wrapped on pallets for ease of handling, care should be taken at all times when moving Key Stonework Cast Stone around the site. The following guidelines should be adhered to:-

- Pallets should be stored on flat ground and not double staked.
- The outer wrapping should not be removed until the products are ready to install.
- After installation the stonework should be protected against damage from other on-site work.

Colours

Key Stonework Cast Stone is available in the following colours:-
Portland and Bath.
Special colours are available upon request.





Key Stonework Ltd

Architectural Stonework Solutions

Head Office

28 The Leys · Long Buckby
Northamptonshire · NN6 7YD
Email: info@keystonework.co.uk
Web: www.keystonework.co.uk
Tel: +44 (0) 1327 842 585
Fax: +44 (0) 1327 651 185