

### **Installation, Operation and Maintenance Instructions**

1100°C Ashing Furnace - AAF Model: 3 Litres  
3216 Controller

AAF 11/3 + 3216 Controller

## Contents

This manual is for guidance on the use of the Carbolite Gero product specified on the front cover. This manual should be read thoroughly before unpacking and using the furnace or oven. The model details and serial number are shown on the back of this manual. Use the product for the purpose for which it is intended.

1.0	Symbols and Warnings .....	5
1.1	Switches and Lights .....	5
1.2	General Warnings .....	5
2.0	Installation .....	6
2.1	Unpacking and Handling .....	6
2.2	Siting and Setting Up .....	6
2.3	Chimney .....	7
2.4	Electrical Connections .....	8
3.0	3216 Controller .....	10
3.1	PID control .....	10
3.2	3216P1 .....	10
3.3	3216P5 .....	10
3.4	Operation .....	10
3.4.1	Controller Layout .....	10
3.4.2	Keys .....	11
3.5	Quick Start Guide .....	11
3.5.1	Operation as a simple controller .....	11
3.5.2	Changing the Setpoint .....	11
3.5.3	Using the Controller .....	11
3.5.4	Understanding User Levels .....	12
3.6	Setting up the Controller .....	13
3.6.1	Maximum Output Power .....	13
3.6.2	Customer ID .....	13
3.6.3	Units .....	13
3.6.4	Language .....	13
3.6.5	Scrolling Text .....	13
3.6.6	Customer Calibration .....	14
3.6.7	Holdback .....	14
3.7	Programming .....	16
3.7.1	Creating a Program .....	16
3.7.2	Program Number (3216P5 Only) .....	16
3.7.3	Ramp Units .....	16
3.7.4	Dwell Units .....	16
3.7.5	Holdback .....	16

3.7.6	Ramp Rate .....	16
3.7.7	Target Setpoint .....	16
3.7.8	Dwell Time .....	16
3.7.9	Running a Program .....	17
3.7.10	Program Status .....	17
3.7.11	Process Value .....	17
3.7.12	PSP, Segment Type and Number .....	17
3.8	Controller Options .....	20
3.8.1	Digital Communications - RS232 .....	20
3.8.2	Digital Communications - RS485 .....	20
3.8.3	Comms Address .....	20
3.8.4	Alarm Option .....	21
3.9	Temperature Controller Replacement .....	21
3.10	3216 Controller Navigation Diagram .....	21
4.0	2132 Over-Temperature Controller Description (if fitted) .....	23
4.1	Description .....	23
4.2	Operation .....	23
4.2.1	Controls .....	23
4.2.2	Operation .....	24
4.2.3	Over-Temperature Operation .....	24
4.2.4	Over-Temperature Alarm .....	24
4.2.5	Resetting the Over-Temperature Alarm .....	24
4.2.6	Sensor Break .....	24
4.3	Audible Alarm .....	25
4.4	Navigation Diagram .....	25
5.0	Operation .....	26
5.1	Operating Cycle .....	26
5.2	General Operating Notes .....	26
5.3	Use of Probes .....	27
5.4	Atmospheres .....	27
5.5	Operator Safety .....	27
5.6	Thermal Catalytic Oxidiser Option .....	28
5.7	Power Adjustment .....	29
6.0	Maintenance .....	30
6.1	General Maintenance .....	30
6.2	Maintenance Schedule .....	30
6.2.1	Cleaning .....	32
6.2.2	Safety Switch .....	32

6.3	Calibration .....	32
6.4	After-Sales Service .....	33
6.5	Recommended Spare Parts and Spare Parts Kit .....	33
7.0	Repairs and Replacements .....	34
7.1	Safety Warning - Disconnection from Power Supply .....	34
7.2	Safety Warning - Refractory Fibre Insulation .....	34
7.3	Temperature Controller Replacement .....	34
7.4	Solid-State Relay Replacement .....	35
7.5	Thermocouple Replacement .....	35
7.6	Element Replacement .....	36
7.7	Door Plug Replacement .....	38
7.8	Fuse Replacement .....	38
8.0	Fault Analysis .....	40
A.	Furnace Does Not Heat Up .....	40
B.	Product Overheats .....	41
9.0	Wiring Diagrams .....	42
9.1	WA-11-30 .....	42
9.2	WA-11-31 .....	43
10.0	Fuses and Power Settings .....	44
10.1	Fuses .....	44
10.2	Power Settings .....	44
11.0	Specifications .....	45
11.1	Environment .....	45

## 1.0 Symbols and Warnings

### 1.1 Switches and Lights



Instrument switch: when the instrument switch is operated the temperature control circuit is energised.



Heat light: the adjacent light glows or flashes to indicate that power is being supplied to the elements.

### 1.2 General Warnings



DANGER – Electric shock. Read any warning printed next to this symbol.  
WARNING: Risk of fatal injury.



DANGER – Hot surface. Read any warning printed next to this symbol.  
WARNING: All surfaces of a product may be hot.



DANGER – Read any warning printed next to this symbol.

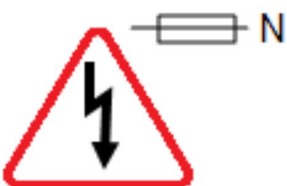

Caution – Double Pole/Neutral Fusing

## 2.0 Installation

### 2.1 Unpacking and Handling

When unpacking and handling the product, always lift it by its base. Do not use the door or any other projecting cover or component to support the equipment when moving it. Use two or more people to carry the product where possible.

Carefully remove any packing material from inside and around the product before use. Avoid damaging the surrounding insulation when removing packing materials.



NOTE: This product contains Refractory Ceramic Fibre (also known as Alumino Silicate Wool - ASW). For precautions and advice on handling this material see section 7.2.

### 2.2 Siting and Setting Up

Place the product on a level surface in a well ventilated area.

Site away from other sources of heat and on a non-flammable surface that is resistant to accidental spillage or hot materials.

The surface on which the equipment is mounted should be stable and not subject to movement or vibrations.

The height of the mounting surface is important to avoid operator strain when loading and unloading samples.

Unless otherwise stated elsewhere in this manual, ensure that there is **at least 150 mm** of free space around the back and sides of the product. Clear space is required above the product to dissipate heat.

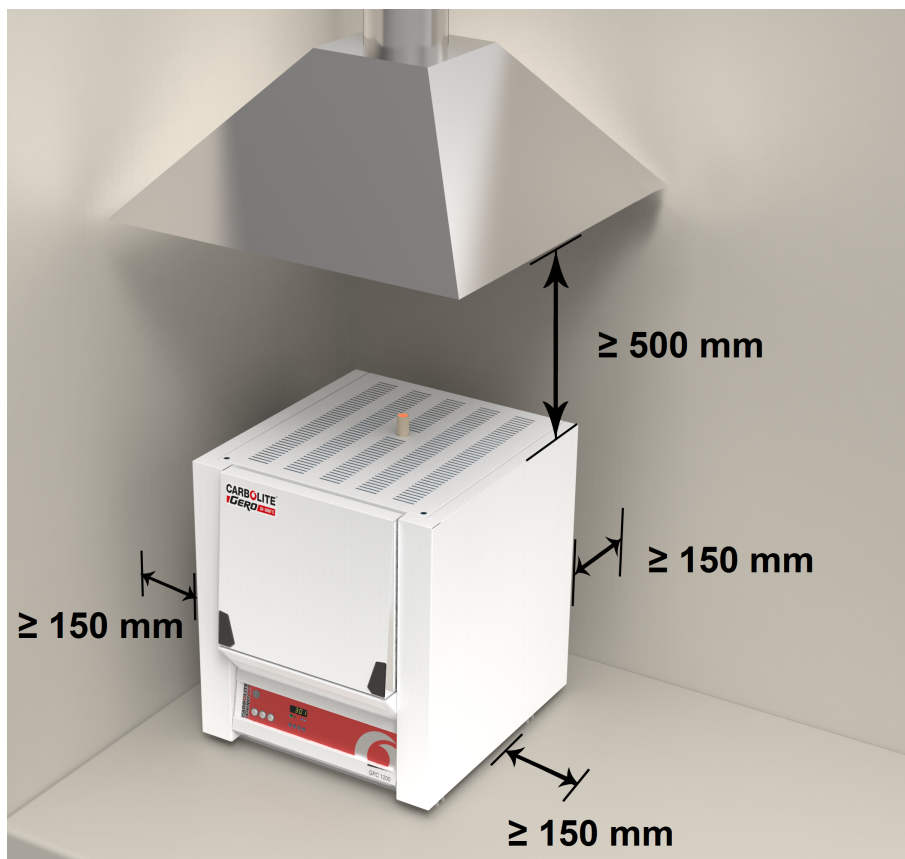

Depending on the application of the product, it may be appropriate to position it under an extraction hood. Ensure the extraction hood is switched on during use.

Ensure that the product is placed in such a way that it can be quickly switched off or disconnected from the electrical supply.



Under no circumstances should any objects be placed on top of the product. Always ensure that any vents on the top of the product are clear of any obstruction. Always ensure all cooling vents and cooling fans (if fitted) are clear of any obstruction.

### 2.3 Chimney

The chimney is a length of tubing. If it is supplied unfitted, then fit it through the hole in the top of the case.

If the product is to be used to heat substances that emit fumes, a fume extraction duct of approximately 75 mm - 150 mm inlet diameter may be placed directly above the chimney outlet.

Do not make a sealed connection to the product chimney as this causes excessive airflow through the chamber and results in poor temperature uniformity.

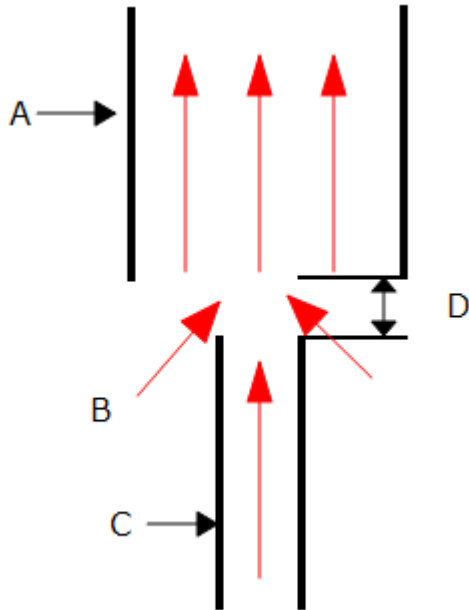

Key	
A	Duct (75mm-150mm diameter)
B	Ambient air is drawn into duct
C	Chimney
D	25mm vertical gap between chimney and duct

## 2.4 Electrical Connections



Connection by a qualified electrician is recommended.

This product requires a single-phase A.C. supply with earth (ground), which may be Live to Neutral non-reversible (polarised), Live to Neutral reversible (non-polarised), or Live to Live.

Check the product rating label before connection. The supply voltage should agree with the voltage on the label and the supply capacity should be sufficient for the current on the label.

The supply should be fused at the next size equal to, or higher than the current on the label. A table of the most common fuse ratings is also given towards the back of this manual. When the mains cable is factory fitted, internal fuses are also fitted. It is essential that the operator ensures that the product is correctly fused.

Products with a factory fitted supply cable are designed to be wired directly to an isolator or fitted with a line plug.

Products without a factory fitted supply cable require a permanent connection to a fused and isolated supply. The product's electrical access panel should be temporarily removed, and connections made to the internal terminals.

If the product is to be connected by line plug. The plug should be within reach of the operator and should be easy to remove.

When connecting the product to an isolating switch ensure that both conductors (single phase) or on all live conductors (three phase), and should be within reach of the operator.

The supply **MUST** incorporate an earth (ground).



## Electrical Connection Details:

Supply	Terminal Label	Cable Colour	Supply Types	
			Live - Neutral	Reversible or Live-Live
1-phase	L	Brown	to live	to either power conductor (For USA 200-240V, connect L1)
	N	Blue	to neutral	to the other power conductor (For USA 200-240V, connect L2)
	PE	Green/ Yellow	to earth (ground)	to earth (ground)

## 3.0 3216 Controller

### 3.1 PID control

This controller uses PID (Proportional Integral Derivative) temperature control. This type of control uses a complex mathematical control system to adjust the heating power and achieve the desired temperature.

### 3.2 3216P1

The 3216P1 is a digital temperature controller which uses PID algorithms to give excellent temperature control. This controller can store and operate a single program of 8 ramp/ dwell segments. The 3216P1 can also be used as a simple temperature controller.

### 3.3 3216P5

The 3216P5 is a digital temperature controller which uses PID algorithms to give excellent temperature control. This controller can store up to 5 programs of 8 ramp/ dwell segments. The 3216P5 can also be used as a simple temperature controller.





## 3.4 Operation

### 3.4.1 Controller Layout



Key	
A	Power Output Indicator
B	Alarm Indicator
C	Remote Indicator (when configured)
D	Page
E	Scroll
F	Down
G	Up
H	Run Indicator
I	Hold Indicator
J	Setpoint Temperature (SP)
K	Measurement Temperature

### 3.4.2 Keys

Page Key		The page key is used to access level 2 when held down for 3 seconds.
Scroll Key		The scroll key is used to scroll through parameters.
Ack		When pressed simultaneously the ACK function is used to:
Page and Scroll		<ul style="list-style-type: none"><li>• Return to the Home Menu</li><li>• Acknowledge an alarm if activated.</li><li>• Reset a program after the program has ended.</li></ul>
Arrow Keys		The arrow keys are used individually to adjust the selected parameters and in combinations to operate a program.



Note: If a parameter is selected and no further action is taken, the display will time out and revert back to the home display in its working level after approximately 1 minute.

## 3.5 Quick Start Guide

### 3.5.1 Operation as a simple controller

When switched on, the controller goes through a short test routine and then shows the measured temperature (PV = Process Value) in the upper part of the display and below it, the desired temperature (Setpoint).

### 3.5.2 Changing the Setpoint

Press Up  or Down  to select the required SP. If the SP is higher than the measured temperature, the OP1 indicator will illuminate in the top left corner of the display, indicating that the controller is calling for power (giving an output).

The controller will immediately attempt to reach the setpoint and then maintain it.

This will cause the product to heat as quickly as possible which may not be appropriate where the product contains sensitive ceramic components. For products with ceramic components, e.g. a tube furnaces fitted with a long ceramic work tube, use the ramp rate feature set with a low heating rate such as 5°C per minute (300°C per hour), to prevent damage.

### 3.5.3 Using the Controller





The parameters in the controller are first shown by a short code (mnemonic). After 5 Seconds a description of the parameter will scroll once along the display and then revert back to the mnemonic. The scrolling text can be interrupted at any time by a single press of any of the buttons, but will not scroll again until the parameter is returned to. In this manual the mnemonic will be shown first, followed by the scrolling text in brackets; e.g. PROG <PROGRAM NUMBER>

### 3.5.4 Understanding User Levels

There are two user levels in the controller; Level 1 (Operator) and Level 2 (Supervisor). Level 1 (Operator) is for the day to day operation of the controller. These parameters are not protected by a security code.

Level 2 (Supervisor) provides access to additional parameters. Access to this level protected by a security code

#### To Enter Level 2



1. Press and hold the page key  for 3 seconds.
2. The display will show LEu 1 GOTO
3. Release the page Key
4. Press the up  or down  to choose LEu 2 (level 2)
5. Press the up  or down  to enter the code (Level 2 Code = 9).

If the correct code is entered, PASS should momentarily be displayed and then revert to the level 2 home display.

If an incorrect code is entered the display reverts back to Level 1 home display.

When level 2 operations have been completed, the supervisor must return to Level 1 either manually or by switching the instrument off and back on. There is no time out function.

#### To Return to Level 1

1. Press and hold the page Key 
2. Press down  to select LEu 1



It is not necessary to enter a code when going from a higher level to a lower level.

When level 1 is selected, the display reverts to the home display (See Controller Layout)

#### Table showing parameters accessible in level 1 and Level 2

Operator LEVEL 1	Supervisor LEVEL 2
home display	home display
Programming	Programming
Program Status	Program Status
	Alarms (if configured)
	Current Transformer Input (if configured)
	Comms (if configured)
	Controller Setup
	Customer Calibration



#### TIP

If while navigating the controller, a parameter has been passed or you need to access parameters which would be at the end of a scroll list, press and hold scroll  and use up  to return to a previous parameter.

## 3.6 Setting up the Controller

Before using the controller (or during its lifetime) certain parameters may have to be set, depending on specific requirements. To do this the controller must be set to supervisor level (Level 2).

### 3.6.1 Maximum Output Power

Press scroll  until the display shows OP.HI <OUTPUT HIGH>. Use the up  and down  keys to select the output power required as a percentage. Once the setting is made, turn the instrument switch off and on to power cycle the temperature controller.



Depending on the furnace or oven model, the maximum output power setting OP.Hi may be accessible or locked.

For silicon carbide heated furnaces, the parameter is accessible to allow compensation for element ageing.

In many models the maximum output power setting depends on the supply voltage, see section 10.0.

### 3.6.2 Customer ID

A furnace or oven identification number can be entered if required. This maybe used to identify one of many units for production or quality control systems.

Press scroll  until the display shows ID <CUSTOMER ID>. Use the up  and down  keys to enter your own identification number. This can range from 1-9999.

### 3.6.3 Units

Press scroll  until the display shows UNITS <DISPLAY UNITS>. Use the up  or down  keys to select the required units.

Mnemonic	Description
NONE	No units (Default °C)
°C	Celsius
°F	Fahrenheit
°K	Kelvin
PERC	% (shows °C value)

### 3.6.4 Language

The scrolling text on the 3216 can be shown in different languages, this can only be set at the factory and therefore must be specified at the time of placing an order.

### 3.6.5 Scrolling Text

If at any time the scrolling text is not required.

Press and hold the page  for three seconds until "GOTO" is displayed.



Press scroll  until the display shows. TEXT <ENABLE/ DISABLE SCROLLING TEXT>  
Use the up  and down  keys to select ON or OFF.



### 3.6.6 Customer Calibration



The 3216 Controller series are calibrated for life at manufacture, there may however be sensor or other system errors, which affect the accuracy of the measured temperature. Customer calibration can be used to compensate for these errors.



#### Dual Offset



Dual point calibration uses two offset values at two corresponding temperatures; this changes the calibration linearly as the temperature increases or decreases.

Press scroll  until the display shows CAL.P (Enter Calibration Code) Use the up  down  keys to enter the password code. (Calibration Pass Code = 95). When the correct password has been entered the display will show PNT.LO. If the wrong pass code is entered the display will revert to zero pass code, until the correct pass code is entered.

When the correct pass code is entered and PNT.LO (Adjust Low Point) is displayed. Use the up  and down  keys to enter the Low Temperature Point, which you want to apply an Offset.

Press scroll  until the display shows OFS.LO (Adjust Low OFFset). Use the up  and down  keys to enter the amount Offset you want to apply to the Low Temperature Point.

Press scroll  until the display shows PNT.HI (Adjust High Point). Use the up  and down  keys to enter the High Temperature Point, which you want to apply an Offset.

Press scroll  until the display shows OFS.HI (Adjust High OFFset). Use the up  and down  keys to enter the amount Offset you want to apply the High Temperature Point.

Once the calibration details have been entered, press scroll  until the display shows the next required parameter or return to the home list. The calibration data will now be protected by the pass code. To edit the data the above procedure must be followed.

#### Single Offset

If a constant offset is required across the temperature range, set the required "High Point" (PNT.HI) and "Low Point" (PNT.LO) to the required values (not the same), then set the "low Offset" (OFS.LO) and "High Offset" (OFS.HI) to the same value.





Caution! - Do not make PNT.LO and PNT.HI the same value as the controller will not work correctly and could cause the product to overheat.

### 3.6.7 Holdback

If the temperature ramp rate of the program is quicker than the product can achieve, the program will wait until the temperature of the product catches up.

e.g. If a holdback value of 10 is set and the program is set to ramp to a setpoint of 600 °C, the program will reach 600 °C, then go into a hold state; the hold indicator will light until the product temperature reaches 590 °C, the program will then continue to control again.

The holdback will only apply once per segment, therefore when control has been re-established, the holdback will not apply again to that segment, even if the product temperature goes outside the holdback band.

Holdback can only be accessed in supervisor level (level 2) by scrolling with the scroll  until the display shows H.BACK <PROGRAM HOLDBACK>: Use the up  and down  keys to select the required Holdback value.

If a multi programmer is used, each program can have its own holdback value assigned to it.

Note: When a holdback is set, each segment used must have a Ramp Rate assigned to it, in order for it to be recognised by the program.

## 3.7 Programming

### 3.7.1 Creating a Program



Programs can be created in level 1 or level 2 of the 3216P1 and 3216P5. Each program contains 8 Ramp/ Dwell pairs.

Note: A currently active program cannot be altered. Go into 'Reset' mode before starting to create or modify a program

### 3.7.2 Program Number (3216P5 Only)

Press scroll  until the display shows PROG <PROGRAM NUMBER.> Select the program number.



### 3.7.3 Ramp Units

Press scroll  until the display shows RAMP.U <Ramp Units>: Use the up  down  to select the Ramp Units of Hour, Min or Seconds.



### 3.7.4 Dwell Units

Press scroll  until the display shows DWEL.U <Dwell Units>: Use the up  down  to select the Dwell Units of Hour or Min.

### 3.7.5 Holdback

see section 3.6. Press scroll  until the display shows H.BACK <Program Holdback>: If a holdback value is required, use the up  down  to enter the required value or select "OFF" if no holdback is required.

### 3.7.6 Ramp Rate



Press scroll  until the display shows RMP.1 <Ramp Rate 1>: Using the up  down  enter the value for the first ramp rate depending on the Ramp Units selected. If the Ramp segment is not required select "OFF".

### 3.7.7 Target Setpoint

Press scroll  until the display shows T.SP 1 <Target SP 1>: Enter the temperature that you want the product to ramp up to using "Ramp rate 1".

If "Ramp Rate 1" has been set to "OFF". The product will Heat/ Cool directly to the Target SP.

### 3.7.8 Dwell Time

Press scroll  until the display shows DWELL. 1 <DWELL TIME 1>: Enter the time to dwell at "Target SP 1". If the dwell segment is not required, use the down  to select OFF, which is below the Zero value.

This Process is repeated for each of the 8 segments of the program.



If not all the segments are used for a program, the Ramp & Dwell of each of the subsequent segments should be set to OFF.









A program will end in one of two ways, either revert to the control setpoint or dwell at the temperature set in the last segment used. When a program finishes on a dwell and the dwell time expires the temperature will revert to the control setpoint.

Note: Before operating a program ensure that the control setpoint is set to Zero to avoid unexpected heating at the end of the program.

### 3.7.9 Running a Program

If using the 3216P5 controller press scroll  to display PROG <PROGRAM NUMBER>. Select the required Program Number before operating a Program.

Table below shows the key presses to operate a program.

Operation	Action	Indication
To RUN a program	Press and quickly release  + 	Indicator – RUN = ON Scrolling Display – Current Program state
To HOLD a program	Press and quickly release  + 	Indicator – RUN = Flashing Scrolling Display – Program Hold
To RESET a program	Press and hold  +  for more than 1 second	Indicator – RUN = OFF Scrolling Display - None
	Program Ended	Indicator – RUN = OFF Scrolling Text – Program End
To RESET a program after it has completed	Press and hold  +  for more than 1 second or press and quickly release Ack 	Indicator – RUN = OFF Scrolling Display - None

### 3.7.10 Program Status

While the program is operating in level 1 or level 2, the home display shows two values at any one time:

#### 3.7.11 Process Value

The upper display shows the current temperature of the product.

#### 3.7.12 PSP, Segment Type and Number

The lower display continually alternates between the programs current set value (Program SP = PSP) and scrolling text, indicating the current status of the program whether RAMP or DWELLING followed by the segment number.

Additional information can be obtained using the scroll  key while the program is operating.

### Working Output Power

From the home display, press scroll  until the display shows WRK.OP <WORKING OUTPUT POWER>. This shows the power being used as a percentage.

### Time Remaining





Press scroll  until the display shows T.REMN <TIME REMAINING>. This shows the dwell time remaining for the current segment. There is no value for "Ramp Time Remaining" therefore when the program is ramping the dwell time set will be shown and will only begin to count down when the ramp has finished.

### Program Review

Further presses of scroll  will reveal the settings of the current program operating. These parameters are locked, while the program is operating.

### Program Hold with Holdback

If a holdback value has been set (see section 3.6) and the program goes into a hold state, the red "HLD" indicator will light, until the current temperature catches up.

If while in this condition the program itself is put into "Hold" by pressing the up , down  together, the "HLD" indicator will turn off and the "Run" indicator will flash, indicating the program is on hold. When the program is started again by pressing the up , down  together, the "Run" indicator will stop flashing and show continually and the "HLD" indicator will light, if the current temperature has not caught up with the program.

### Power Failure

If there is a power failure while the program is operating and the power is subsequently restored, the scrolling text will read <POWER FAIL - PROGRAM RESET>.

Press the "ACK" function to acknowledge this message, press the "ACK" function again to reset the program.

### Alarms

Alarms are used to alert the operator when a pre-set level has been exceeded or a function error has occurred such as a sensor break. They are indicated by a scrolling message on the display and a flashing red ALM (Alarm) indicator. The alarm may also switch an output – usually a relay to allow external devices to be operated when an alarm occurs. Alarms only operate if they have been configured and are dependent on customer requirements.

How to acknowledge an alarm will depend on the type of latching which has been configured. A non-latched alarm will reset itself when the alarm condition is removed. A latched alarm requires acknowledgement with the "ACK" function before it is reset.



















If an alarm has been activated the red "ALM" indicator will light and the scrolling text will indicate the type of alarm.

To acknowledge an alarm and cancel the "ALM" indicator, press "ACK" function.

Note: The alarm indicator may seem to be permanently on when viewed from above. When an alarm is active the indicator should only be flashing, to confirm this, the controller must be viewed directly from the front.

**Program Example**

The following sequence of entries creates and runs the program shown graphically below.

1. Press scroll  until the display shows RAMP.U <SP RAMP UNITS>. Select MIN.
2. Press scroll  until the display shows DWELL.U <DWELL UNITS>. Select MIN.
3. Press scroll  until the display shows RMP.1 <RAMP RATE 1>. Select 5
4. Press scroll  until the display shows T.SP1 <TARGET SP 1>. Select 600
5. Press scroll  until the display shows DWEL.1 <DWELL TIME 1>. Select 30
6. Press scroll  until the display shows RMP.2 <RAMP RATE 2>. Select 4
7. Press scroll  until the display shows T.SP2 <TARGET SP 2>. Select 400
8. Press scroll  until the display shows DWEL.2 <DWELL TIME 2>. Select 30
9. Press scroll  until the display shows RMP.3 <RAMP RATE 3>. Select OFF
10. Press scroll  until the display shows T.SP3 <TARGET SP 3>. Select 600
11. Press scroll  until the display shows DWEL.3 <DWELL TIME 3>. Select 60
12. Press scroll  until the display shows RMP.4 <RAMP RATE 4>. Select 3
13. Press scroll  until the display shows T.SP4 <TARGET SP 4>. Select 800
14. Press scroll  until the display shows DWEL.4 <DWELL TIME 4>. Select OFF
15. Press scroll  until the display shows RMP.5 <RAMP RATE 5>. Select 5
16. Press scroll  until the display shows T.SP5 <TARGET SP 5>. Select 400
17. Press scroll  until the display shows DWEL.5 <DWELL TIME 5>. Select 480
18. Press the ACK function to return to the home display.
19. Press the up  and down  keys together, to operate the program.

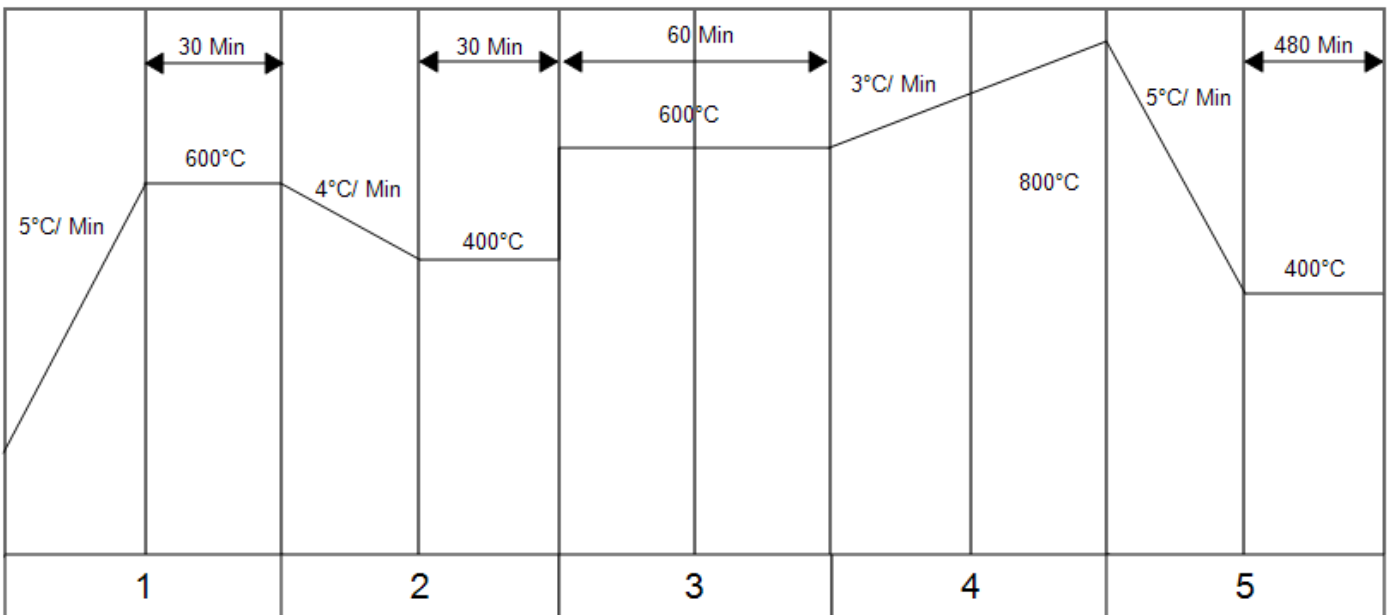

Segment

1	2	3	4	5
RMP.1= 5°C/Min	RMP.1= 4°C/Min	RMP.1= OFF	RMP.1= 3°C/Min	RMP.1=5°C
T.SP1= 600°C	T.SP1= 400°C	T.SP1= 600°C	T.SP1= 800°C	T.SP1= 400°C
Dwel.1= 30 Min	Dwel.1= 30 Min	Dwel.1= 60 Min	Dwel.1= OFF	Dwel.1= 480 Min

### 3.8 Controller Options

As options can be ordered in a variety of combinations and for a variety of purposes, exact instructions are not given here. The full Eurotherm manual may be required to determine customer parameter settings. To reveal or hide parameters in the controllers it is necessary to go into configuration mode, a security code is needed. Please consult Carbolite Gero.

#### 3.8.1 Digital Communications - RS232

If the RS232 option is supplied, the furnace is fitted with one sub-miniature D-socket connected to the controller comms module. RS232 is suitable for direct connection to a personal computer (PC) using a "straight through" cable as follows (the linked pins at the computer end are recommended but may not be necessary). The cable is usually 9-pin at the furnace end and 9-pin at the computer, but other alternatives are shown in parentheses.

Product end of cable female (25-pin) 9-pin			<b>RS232 Cable: product to PC</b>	Computer end of cable 9-pin (25-pin) male		
Rx	(2)	3	—————	3	(2)	Tx
Tx	(3)	2	—————	2	(3)	Rx
Com	(7)	5	—————	5	(7)	Com
				7,8 1,4,6	(4,5) (6,8,20)	Link together Link together

#### 3.8.2 Digital Communications - RS485

If an RS485 option is supplied, the furnace is fitted with two D-sockets. Connection between products is by "straight" cable as follows:

Product end of cable female (25-pin) 9-pin			<b>RS485 Cable: product to PC</b>	Computer end of cable 9-pin (25-pin) female		
-	(2)	3		3	(2)	Tx
+	(3)	2		2	(3)	Rx
Com	(7)	5	—————	5	(7)	Com

#### 3.8.3 Comms Address

Typically the comms address is set to 1, but this can be changed. In the case of RS485 and multiple instruments it is necessary to set different addresses. To change the

address value, access the level 2 list. In level 2 press the page key until the COMMS parameter is displayed. Press up ▲ down ▼ to select the address value.

3.8.4 Alarm Option

When an alarm board is fitted, which consists of a relay with voltage free contacts, for operator use, the contacts are taken to a panel plug on the control panel, wired as indicated:

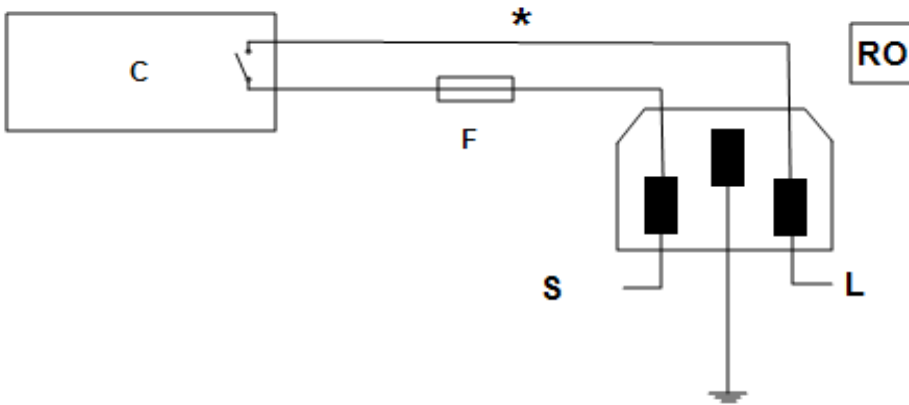

Key	
C	Temperature Controller
F	Fuse (2A)
S	Supply
L	Load
*	Normally open relay contacts
RO	Relay Output 240V 2A MAX

The purpose of the 2 amp fuse is to break the circuit to prevent overloading on the circuit due to high voltage.

The instrument configuration and parameters available to the operator depend on the customer requirements.

**3.9 Temperature Controller Replacement**



Before handling the controller: wear an anti-static wrist strap or otherwise avoid any possibility of damage to the unit by static electricity. Refer to the detailed instructions supplied with the replacement controller.

Ease apart the two lugs at the side; grip the instrument and withdraw it from its sleeve; push in the replacement.

**3.10 3216 Controller Navigation Diagram**

The following diagram details how to navigate to the various menu options within the 3216 Controller. At each option, values can be set using the arrow keys.

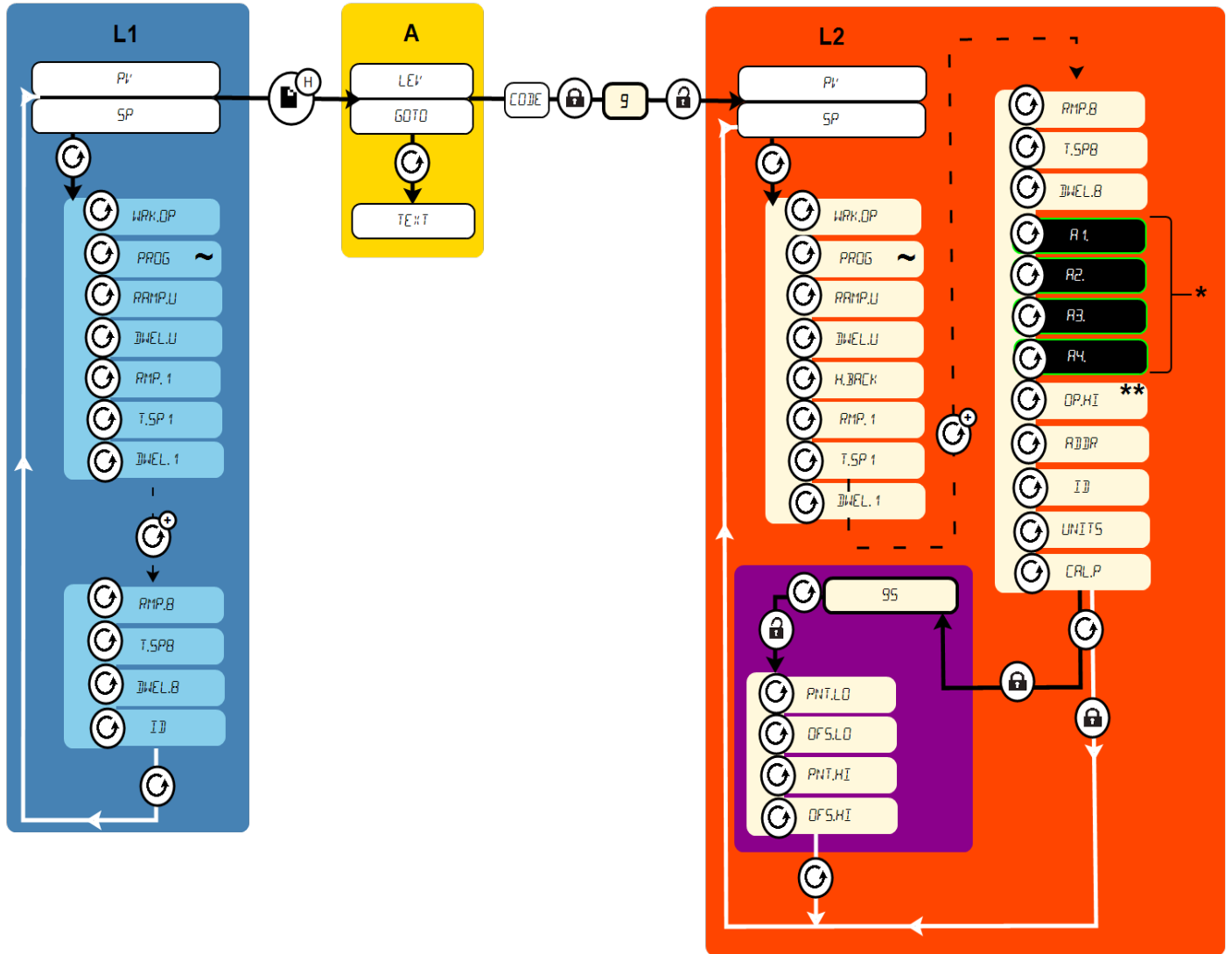

L1	Level 1		Press the Scroll Key		Hold the Page key for 3 seconds
L2	Level 2		Press the Scroll Key multiple times		Locked - password required
A	Access	*	If configured		Unlocked
**	Do not raise the power limit (if accessible) above the design level for the product	~	Multiple Program Only		Black = Progress Dashed = Through multiple menus White = Return

## 4.0 2132 Over-Temperature Controller Description (if fitted)

### 4.1 Description



This over-temperature controller is fitted and supplied ready to use by Carbolite Gero. It is a digital instrument with a latching alarm, requiring no additional panel controls. The controller features easy setting of over-temperature setpoint and reading of current temperature by the over-temperature sensor.

### 4.2 Operation

#### 4.2.1 Controls

Most Carbolite Gero products are fitted with an instrument switch which cuts off power to the controller and other parts of the control circuit.

To operate the controller, power must be supplied to the product and the instrument switch must be on. If a time switch is included in the product circuit, this must be in the 'ON' position.

When an over-temperature condition occurs, the controller cuts the power to a contactor, which in turn cuts power to the heating elements. Power is not restored until the controller is 'reset'.

Some components will operate after the over-temperature feature isolates the power supply e.g. cooling fans will continue to operate, provided that there is a power supply to the product. In some cases the product may not do so, if other options (such as a door switch) are fitted.

### 4.2.2 Operation

When switched on, the controller lights up, goes through a short test routine and then displays the measured temperature or the over-temperature setpoint.

The page key  allows access to parameter lists within the controller.

A single press of the page key  displays the temperature units, normally set to °C; further presses reveal the lists indicated in the navigation diagram.



The scroll key  allows access to the parameters within a list. Some parameters are display-only; others may be altered by the operator.

A single press of the scroll key  in the 'Home' list displays the temperature units; further presses reveal the parameters in the current list indicated in the navigation diagram.

To return to the 'Home' list at any time, press page  and scroll  together, or wait for 45 seconds.

The down  and up  keys are used to alter the setpoint or other parameter values.

### 4.2.3 Over-Temperature Operation

Use down  and up  to alter the over-temperature setpoint. This should normally be set a little above the working temperature (for example 15 °C above). The product is supplied with the over-temperature set at 15 °C above the furnace or oven maximum working temperature.

Press scroll  twice view the present temperature as measured by the over-temperature controller. Press it twice, the first press shows the temperature units (°C).

### 4.2.4 Over-Temperature Alarm

If an over-temperature condition occurs, the OP2 indicator flashes and an alarm message 2FSH also flashes, alternating with the setpoint. Power to the heating elements is disconnected.

### 4.2.5 Resetting the Over-Temperature Alarm

To acknowledge the alarm press scroll  and page  together.

If the alarm is acknowledged while there is still an over-temperature condition, the OP2 indicator stops flashing but continues to glow. The 2FSH alarm continues to flash until the over-temperature condition is cleared (by the temperature falling), when normal operation resumes.

If the alarm is acknowledged when the temperature has dropped (or after the over-temperature setpoint has been raised) so that the over-temperature condition no longer exists, then the furnace or oven immediately resumes normal operation.

### 4.2.6 Sensor Break

The over-temperature cut-out system also operates if the over-temperature control thermocouple breaks or becomes disconnected. The message S.br flashes where the measured temperature is normally displayed.



### 4.3 Audible Alarm

If an audible alarm is supplied for use with the over-temperature controller, it is normally configured to sound on over-temperature condition and to stop sounding when the alarm is acknowledged as given in section 4.2.

Note: the alarm may sound during controller start-up.

### 4.4 Navigation Diagram

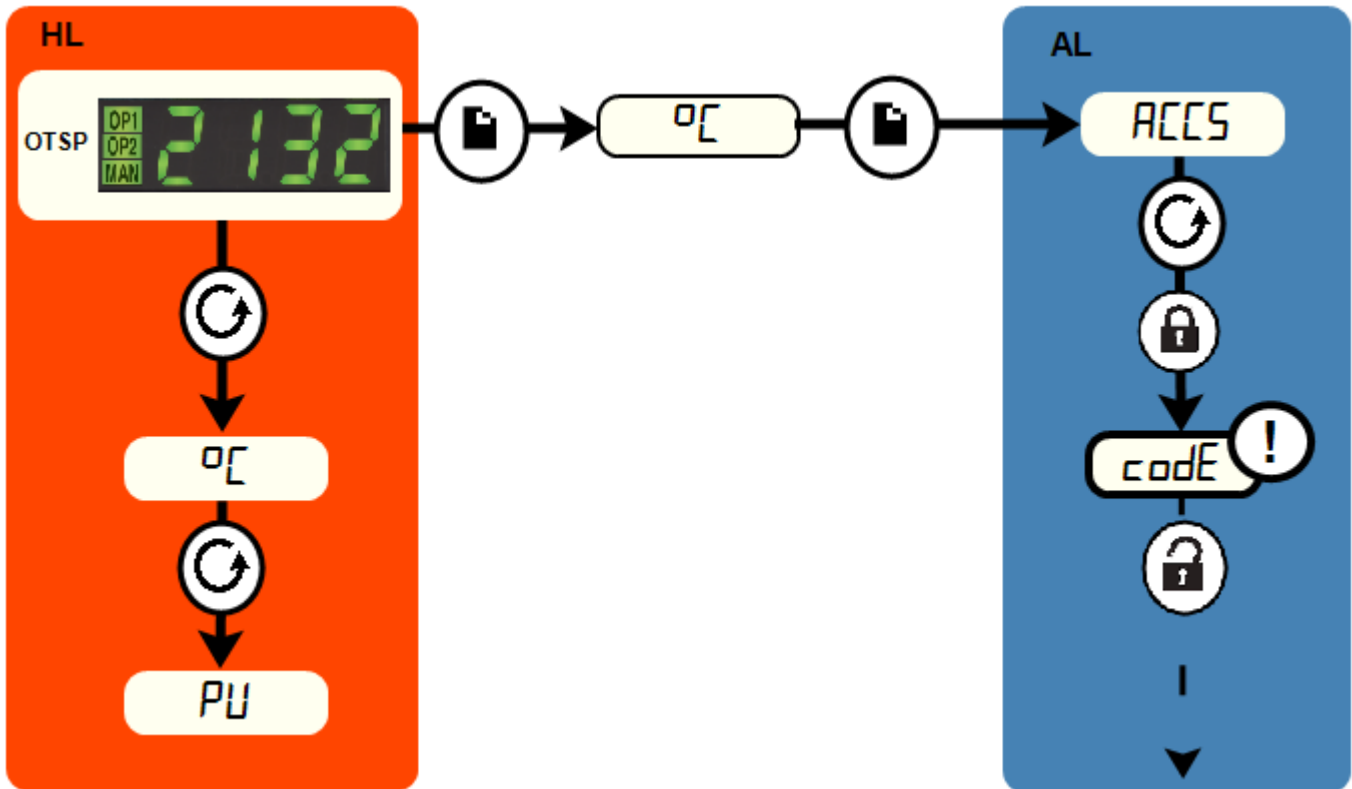

<b>HL</b>	Home List		Page Key	➔	Black = Progress
<b>OTSP</b>	Over-Temperature Setpoint		Scroll Key		Dashed = Through to other options
<b>AL</b>	Access List		For factory access to list and parameters not available to the operator.		

## 5.0 Operation

### 5.1 Operating Cycle

This product is fitted with an instrument switch which cuts off power to the control circuit.

Connect the product to the electrical supply.

Turn on the instrument switch to activate the temperature controllers. The controllers illuminate and go through a short test cycle.

**Over-Temperature option only.** If the digital over-temperature option has not yet been set as required, set and activate it according to the over-temperature controller instructions.

The product will heat up according to the controller setpoint or program, unless a time switch is fitted and switched off.

As the product heats up, the heat light glows steadily at first and then flashes as the product approaches the desired temperature. For more information on temperature control see the controller instructions.

**Over-Temperature option only.** If the over-temperature circuit has tripped, an indicator on the over-temperature controller flashes and the heating elements are isolated. Find and correct the cause before resetting the over-temperature controller according to the instructions supplied.

To turn the product off, set the instrument switch to its off position. The controller display will go blank. If the product is to be left unattended, isolate it from the electrical supply.

### 5.2 General Operating Notes



Heating element life is shortened by overheating. Do not leave the product at high temperature when it is not required. The maximum temperature is shown on the product rating label and in section 11.0 towards the back of this manual.

When heating large objects, in particular poor conductors, avoid shielding the thermocouple from the heating elements. The thermocouple is intended to sense the temperature near the heating elements. However, if a large object is placed in the chamber it may record the average temperature of the object and the elements, this can lead to overheating of the elements. Allow large objects to gain heat at a lower temperature and then reset the controller to a temperature close to the desired maximum, or heat using a slowly controlled ramp rate. For more information refer to the controller instructions.

When heating materials that produce smoke or fumes, the chimney must be correctly fitted and unobstructed. If not, soot will accumulate in the chamber and could possibly cause an electrical breakdown of the heating element. If the furnace is used to heat

materials that emit smoke or fumes, regularly heat it up to maximum temperature for one hour with the chamber empty to burn away the soot.

Materials such as case hardening compounds and other reactive salts may penetrate the furnace chamber lining and attack the wire elements, causing premature failure. Use of a hearth tile may be advisable: please consult the Carbolite Gero technical department.

### 5.3 Use of Probes



Any metal object used to probe into the product chamber while the product is connected to the electrical supply must be earthed. This applies in particular to metal sheathed thermocouples, where the sheaths must be earthed. The refractory material of the chamber lining becomes partly conductive at high temperatures and the electric potential inside the chamber can be at any value between zero and the supply voltage. Unearthed probes can cause serious electric shock.

### 5.4 Atmospheres

When an optional gas inlet is fitted, there is a label near the inlet saying "INERT GAS ONLY". In practice, inert or oxidising gases may be used, but not combustible or toxic gases.

The chamber is not gas tight, the gas usage may be high and the chamber is always likely to contain some air. Residual oxygen of approximately 1% to 2% is to be expected.

### 5.5 Operator Safety



This product incorporates a safety switch which interrupts the heating element circuit when the furnace is opened. This prevents the operator touching a live heating element and also prevents the product from heating up if the furnace is left open. The operation of this switch should be checked periodically.



Depending on use, the surfaces in the working chamber and the chamber load may still be very hot after the appliance is switched off. Touching these surfaces may cause burns. Use suitable personal protective equipment or wait until the appliance cools down to ambient temperature.

Before removing a hot object from the product, make sure there is a safe place to put it down. If necessary use tongs, face masks and heat resistant gloves. Heat resistant clothing and face protection can guard against the effects of radiated heat when the furnace is open.

When the product is opened during operation there is considerable radiated heat. Do not keep any flammable objects near the product, nor objects which could be damaged by radiated heat.

## 5.6 Thermal Catalytic Oxidiser Option

Catalytic oxidation allows the purification of exhaust air from volatile organic components at low temperature without an open flame. By the use of a suitable catalyst, complete oxidation of the volatiles takes place at temperatures between 250°C and 400°C. Due to the low reaction temperature, catalytic oxidisers require very little energy. Compared to other exhaust gas purification systems, the catalytic oxidiser has a very small footprint.

- The catalyst system has its own power cord and should be powered from a dedicated source, separate from the furnace supply. The catalyst system has a power rating of 0.6kW, and requires a 220-240 volt power supply.
- Always power up the catalyst before heating up the furnace.
- Cool the furnace down below 250°C before turning off the catalyst power supply.
- The catalyst fan has the effect of lowering the pressure in the furnace chamber and assisting fume extraction from the furnace.

**Note:** To avoid damage to the catalyst system, the catalyst fan must always be running whenever the furnace is hot.

Avoid overloading the catalyst system with volatiles. Particulate matter will not be catalysed, so if carbon particles are visible in the exhaust stream, slow the furnace heat up rate and/or reduce the load in the furnace. The furnace should not be loaded when hot, as the rapid evolution of volatiles may be too great for the system to cope with.

If the catalytic effect fails and smoke is constantly exhausted, this may be the result of a poisoned catalyst, failed catalyst heating element or failed exhaust fan.

These items are available as spare parts from Carbolite Gero.

**Note:** The addition of the catalytic afterburner option increases the external dimensions of the furnace. Please refer to the Specifications section of this manual for amended dimensions.



## 5.7 Power Adjustment

The product control system incorporates electronic power limiting. Depending on the model and the destination country the power limit maybe set to 100% or a lower figure. Where appropriate the power limit parameter OP.Hi is accessible to the operator, but it should not generally be altered.

See section 10.0 for details of the power limit settings. DO NOT adjust the power to a level higher than the design level states; this may cause a fuse to blow and could damage the heating elements.

The power limit may be set to a lower limit if the product is to be used at a low temperature only: this may give better control stability. It may be set to zero to permit demonstration of the controls without the heating elements taking power; to resume heating reset it to its standard value.

## 6.0 Maintenance

### 6.1 General Maintenance

Preventive rather than reactive maintenance is recommended. The type and frequency depends on the product use; the following are recommended.









### 6.2 Maintenance Schedule

 CUSTOMER

 QUALIFIED PERSONNEL



**DANGER! ELECTRIC SHOCK.** Risk of fatal injury. Only electrically qualified personnel should attempt these maintenance procedures.

Maintenance Procedure	Method	Frequency				
		Daily	Weekly	Monthly	Bi-Annually	Annually
<b>Safety</b>						
Safety Switch Function	Set a safe temperature above ambient, and open the door to see if the heater light goes out					
Safety Switch Function	Electrical measurement 					
Over-Temperature Safety Circuit (if fitted)	Set an over-temperature setpoint lower than the displayed temperature and check for an over-temperature alarm as detailed in this manual					
Over-Temperature Safety Circuit (if fitted)	Electrical measurement 					
Door Plug	Visual inspection, checking the seal and whether it is free of damage					
Door Plug	Replacement where necessary					
Chimney / Extraction	Check and clean if necessary					
Electrical Safety (external)	Visual check of external cables and plugs					
Electrical Safety (internal)	Physically check all connections and cleaning of the power plate area					
<b>Function</b>						
Temperature Calibration	Tested using certified equipment, frequency dependent on the standard required					

Operational Check	Check that all functions are working normally					
Operational Check	Thorough inspection and report incorporating a test of all functions					6
<b>Performance</b>						
Element Circuit	Electrical measurement 					6
Power Consumption	Measure the current drawn on each phase / circuit					6
Hearth	Visual check for fit and damage					
Cooling Fans (if fitted)	Check whether the cooling fans are working					

### 6.2.1 Cleaning

Soot deposits may form inside the furnace, depending on the process. At appropriate intervals remove these by heating as indicated in the General Operation Notes.



The product's outer surface may be cleaned with a damp cloth. Do not allow water to enter the interior of the case or chamber. Do not clean with organic solvents.

### 6.2.2 Safety Switch

When correctly functioning, the safety switch will isolate all live conductors (live and neutral connections) within the heating element circuit(s) when the product door is opened. The safety switch should be checked regularly to ensure that this occurs.

The safety switch should not fail under normal working conditions, however rough handling, exposure to corrosive materials/ environments, or exceptionally frequent use, could compromise the safety system.

#### **Weekly check:**

The following check can be carried out by a general operator:

- On the temperature controller, set a safe temperature above ambient. The heater lights should illuminate.
- Open the door and check the heater lights. They should no longer be illuminated.

If the heater lights remain illuminated when the door is open, discontinue use and contact Carbolite Gero Service.

#### **Annual check:**

The following checks should be carried out by a qualified electrician, as specified in the "Maintenance Schedule" section of this manual:

- Remove the element access panel and take a voltage measurement from the heating element terminals. Do not attempt to take a reading from the heating element itself as surface oxidation will give an unreliable contact.
- Ensure that power to the heating elements is switched off when the door is opened.

Contact Carbolite Gero Service and discontinue use of the product if it is found that the heating elements are not fully isolated during these checks.

## **6.3 Calibration**

After prolonged use, the controller and/or thermocouple may require recalibration. This is important for processes that require accurate temperature readings or for those that use the product close to its maximum temperature. A quick check using an independent



thermocouple and temperature indicator should be made from time to time to determine whether full calibration is required. Carbolite Gero can supply these items. Depending on the controller fitted, the controller instructions may contain calibration instructions.

#### **6.4 After-Sales Service**

Carbolite Gero Service has a team of Service Engineers who can offer repair, calibration and preventive maintenance of furnace and oven products both at the Carbolite Gero factory and at customers' premises throughout the world. A telephone call or email often enables a fault to be diagnosed and the necessary parts to be despatched.

In all correspondence please quote the serial number and model type given on the rating label of the product. The serial number and model type are also given on the back of this manual when supplied with the product.

Carbolite Gero Service and Carbolite Gero contact information can be found on the back page of this manual.

#### **6.5 Recommended Spare Parts and Spare Parts Kit**

Carbolite Gero can supply individual spare parts or a kit of the items most likely to be required. Ordering a kit in advance can save time in the event of a breakdown.

Each kit consists of one thermocouple, one sheath, one solid state relay, one door insulation piece and a set of elements.

When ordering spare parts please quote the model details and serial number as requested above.

## 7.0 Repairs and Replacements

### 7.1 Safety Warning - Disconnection from Power Supply



Immediately switch the product off in the event of unforeseen circumstances (e.g. large amount of smoke). Allow the product to return to room temperature before inspection.



Always ensure that the product is disconnected from the electrical supply before repair work is carried out.

**Caution:** Double pole/neutral fusing may be used in this product.

### 7.2 Safety Warning - Refractory Fibre Insulation



**Insulation made from High Temperature Insulation Wool Refractory Ceramic Fibre, better known as (Alumina silicate wool - ASW).**

This product contains **alumino silicate wool** products in its thermal insulation. These materials may be in the form of blanket or felt, formed board or shapes, slab or loose fill wool.

Typical use does not result in any significant level of airborne dust from these materials, but much higher levels may be encountered during maintenance or repair.

Whilst there is no evidence of any long term health hazards, it is strongly recommended that safety precautions are taken whenever the materials are handled.

**Exposure to fibre dust may cause respiratory disease.**

**When handling the material, always use approved respiratory protection equipment (RPE-eg. FFP3), eye protection, gloves and long sleeved clothing.**

**Avoid breaking up waste material. Dispose of waste in sealed containers.**

**After handling, rinse exposed skin with water before washing gently with soap (not detergent). Wash work clothing separately.**

Before commencing any major repairs it is recommended to make reference to the European Association representing the High Temperature Insulation Wool industry ([www.ecfia.eu](http://www.ecfia.eu)).

Further information can be provided on request. Alternatively, Carbolite Gero Service can quote for any repairs to be carried out either on site or at the Carbolite Gero factory.

### 7.3 Temperature Controller Replacement

Refer to the controller instructions for more information on how to replace the temperature controller.

## 7.4 Solid-State Relay Replacement



Disconnect the product from the power supply and remove the appropriate cover as given above.

1. Make a note of the wire connections to the solid state relay, then disconnect them.
2. Remove the solid state relay from the base panel or aluminium plate.
3. Replace and reconnect the solid state relay ensuring that the bottom of it has good thermal contact with the base panel or aluminium plate.
4. Replace the access panel.

## 7.5 Thermocouple Replacement



Disconnect the product from the power supply. Remove terminal cover to gain access to the thermocouple connections. Make a note of the thermocouple connections.

Thermocouple cable colour codings are:

<b>Thermocouple leg</b>	<b>Colour</b>
positive (type K)	green
negative	white

Disconnect the thermocouple from its terminal block and withdraw the thermocouple from its sheath by bending the metal tag or releasing the screw to release. It is also advisable to remove the sheath and shake out any broken pieces of thermocouple.

Re-assemble with a new thermocouple, observing the colour coding, ensuring that the thermocouple is not twisted as it is being inserted and that the metal tag is bent back to grip the sheath.

Refit the element access panel.

## 7.6 Element Replacement



**See section 7.2 - wearing a face mask is required.**

The chamber of this type of furnace is formed by winding resistance heating wire on to a refractory muffle former. In the event of failure, the whole "wound muffle" assembly must be replaced.

Disconnect the furnace from the electrical supply and remove the furnace back panel. Pull the chimney out of the top of the furnace.

Make a note of the wiring connections; "Thermocouple Replacement" above which refers to the thermocouple colour coding.

Unfasten the electrical connections to the inner chamber (brick-box) and remove the thermocouple and sheath (see thermocouple replacement instructions). If the connections are secured by hexagonal nuts, two spanners should be used to avoid cracking the porcelain mounting.

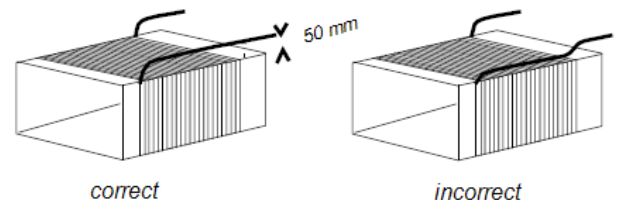

Undo any self-tapping screws and hook bolts necessary to release the brick-box.

Support the front of the brick-box as you withdraw it from the case so it does not fall onto the electrical connections below.

Remove the brick-box lid and top insulating board, noting how it is assembled and observing the position of the heating element wires (or "tails").

Pull the element tails out of the terminal block and remove sufficient insulation to allow access to the heating element. Check and replace damaged insulation.

Fit the new heating element, ensuring that the tails are separated from the element by at least 25 mm (preferably 50 mm) of insulation – see the image above.

Feed the element tails through the terminal blocks and tighten the clamping screws using two spanners as before. Cut off excess element tails.

Complete the fitting of the insulation and refit the lid. Do not use any cement unless supplied by Carbolite Gero, as other types may chemically attack the heating element.

Replace and fasten the brick-box into the furnace case.

Replace the thermocouple and sheath and remake the electrical connections. In porcelain and brass terminal blocks the brass connector should be slightly loose in its porcelain support block to allow for expansion.

Replace the back panel and reconnect the electrical supply.

Switch the furnace ON and heat to 900 °C without interruption and then dwell for 1 hour. Some smoke may be observed during this process, which should be carried out in a well ventilated area.

Check that the furnace is controlling properly to rule out the possibility that previous element failed because of a fault in the control circuit.

## 7.7 Door Plug Replacement



See section 7.2 - wearing a face mask is required.

Open the door and remove the door cover from the plug carrier assembly.

Remove the old door plug by sliding it upwards out of its carrier.

Slide the new plug into the carrier assembly making sure that the plug is the correct way up.

Refit the door cover.

When first heating the furnace after a replacement, ensure that the ventilation is good: emission of some fumes is to be expected.

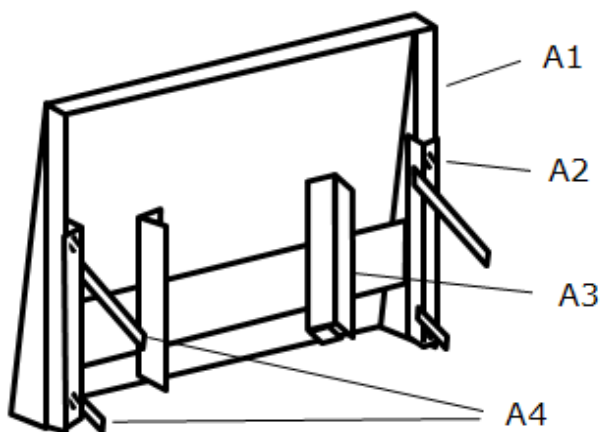

**A**

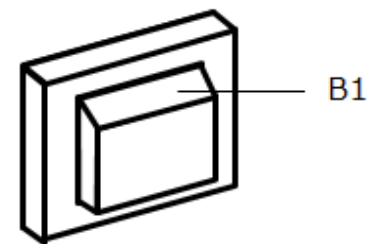

**B**

Key	
A	Door (seen from the back)
A1	Door Cover
A2	Fixing Screws
A3	Door Plug Carrier
A4	Door Link Arms
B	Door Plug
B1	Top

## 7.8 Fuse Replacement

Fuses are marked on the wiring diagram with type codes, e.g. F1, F2. For more information on fuses refer to section 10.0.

*Depending on model and voltage, the different fuse types may or may not be fitted.*

If any fuse has failed, it is advisable for an electrician to check the internal circuits.

Replace any failed fuses with the correct type. For safety reasons do not fit larger capacity fuses without first consulting Carbolite Gero.

The fuses are located at the cable entry point. Remove the back panel or control box back panel to gain access to the fuses.

## 8.0 Fault Analysis

A. Furnace Does Not Heat Up					
1.	The HEAT light is ON	▶	The heating element has failed	▶	Check also that the SSR is working correctly
2.	The HEAT light is OFF	▶	The controller shows a very high temperature or code such as S.br	▶	The thermocouple has broken or has a wiring fault
		▶	The controller shows a low temperature	▶	The door switch(es) (if fitted) may be faulty or need adjustment
				▶	The contactor/relay (if fitted) may be faulty
				▶	The heater switch (if fitted) may be faulty or need adjustment
				▶	The SSR could be failing to switch on due to internal failure, faulty logic wiring from the controller, or faulty controller
		▶	There are no lights glowing on the controller	▶	Check the supply fuses and any fuses in the furnace control compartment
				▶	The controller may be faulty or not receiving a supply due to a faulty switch or a wiring fault.



**B. Product Overheats**

1.	Product only heats up when the instrument switch is ON	▶	The controller shows a very high temperature	▶	The controller is faulty
		▶	The controller shows a low temperature	▶	The thermocouple may be faulty or may have been removed out of the heating chamber
				▶	The thermocouple may be connected the wrong way around
				▶	The controller may be faulty
2.	Product heats up when the instrument switch is OFF	▶	The SSR has failed "ON"	▶	Check for an accidental wiring fault that could have overloaded the SSR

## 9.0 Wiring Diagrams

### 9.1 WA-11-30

Connections below show single phase with indirect safety switch(es).

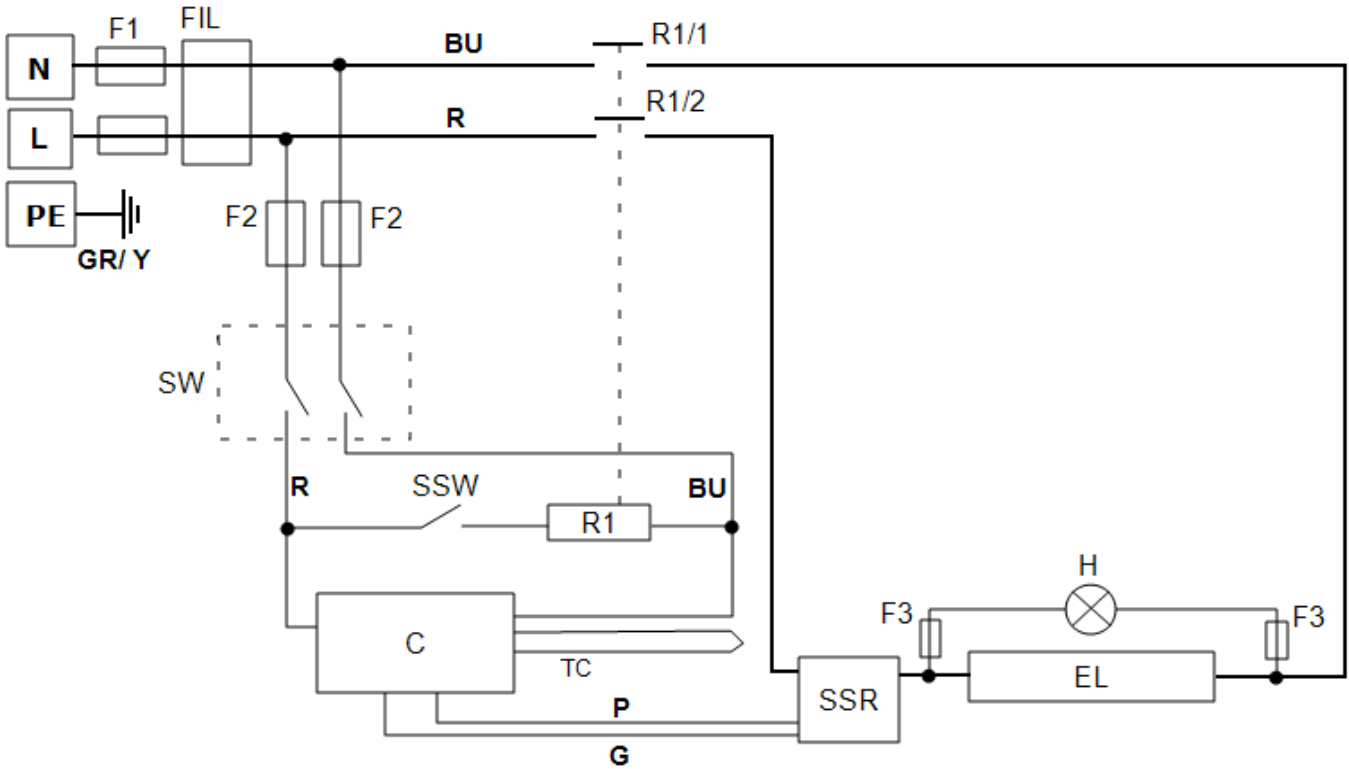

Key	
F1, F2, F3	Fuses
FIL	Filter
R1/1, R1/2	Relay Contactor
R1	Relay
C	Temperature Controller
TC	Control Thermocouple
SSR	Solid State Relay
SSW	Safety Switch
H	Heat Lamp
EL	Element(s)
SW	Instrument Switch(es)
N	Neutral
L	Live
PE	Earth

Cables	
BU	Blue
R	Red
GR/Y	Green + Yellow
G	Grey
P	Pink

**9.2 WA-11-31**

Connections below show single phase with safety switches and over-temperature control.

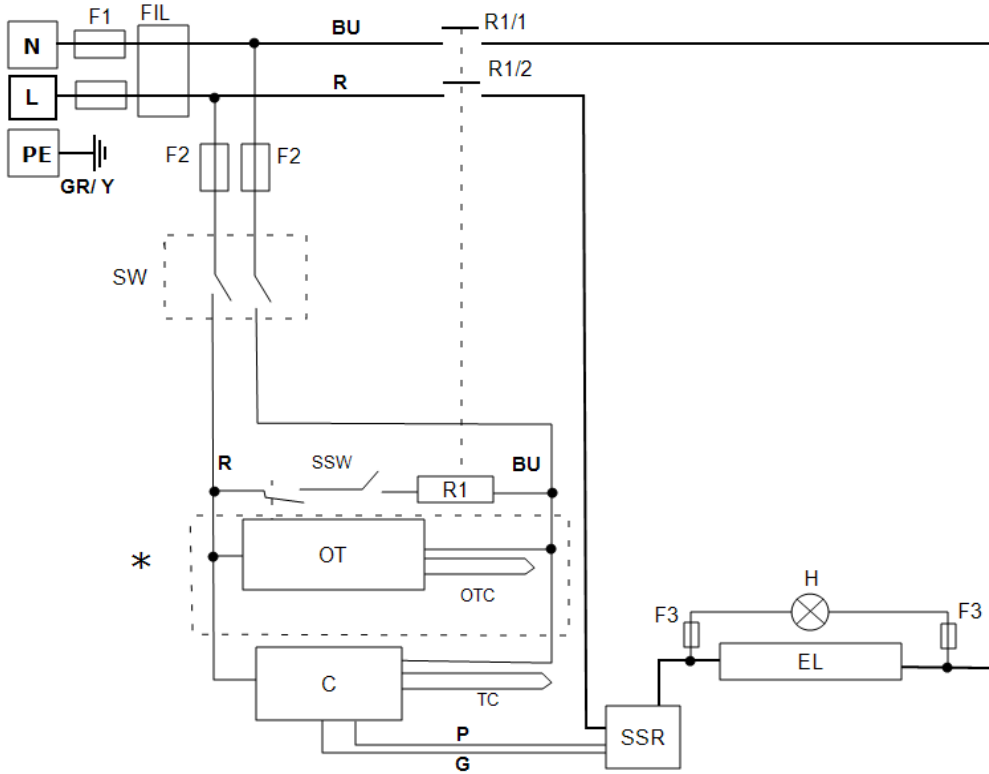

Key	
F1, F2, F3	Fuses
FIL	Filter
R1/1, R1/2	Relay Contactor
R1	Relay
C	Temperature Controller
OT	Over-Temperature Controller
OTC	Over-Temperature Thermocouple
TC	Control Thermocouple
SSR	Solid State Relay
SSW	Safety Switch
H	Heat Lamp
EL	Element(s)
SW	Instrument Switch(es)
N	Neutral
L	Live
PE	Earth
*	If Fitted

Cables	
BU	Blue
R	Red
GR/Y	Green + Yellow
G	Grey
P	Pink

## 10.0 Fuses and Power Settings

### 10.1 Fuses

F1-F3: Refer to the circuit diagrams.

F1	Internal Supply Fuses	Fitted if supply cable fitted. Fitted on board to some types of EMC filter.	GEC Safeclip of the type shown (glass type F up to 16 A) 38 mm x 10 mm type F fitted on EMC filter circuit board(s)
F2	Auxiliary Circuit Fuses	Fitted on board to some types of EMC filter. May be omitted up to 25 Amp/phase supply rating.	2 Amps glass type F On board: 20 mm x 5 mm Other: 32 mm x 6 mm
F3	Heat Light Fuses	May be omitted up to 25 Amp/phase supply rating.	2 Amps glass type F 32 mm x 6 mm
	Customer Fuses	Required if no supply cable fitted. Recommended if cable fitted.	See rating label for current; See table below for fuse rating.

Model	Phases	Volts	Supply Fuse Rating
AAF 11/3	1-phase	100-120	25 A
AAF 11/3	1-phase	200-240	10 A

### 10.2 Power Settings

The power limit settings (parameter OP.Hi) for this model are voltage dependant. The figures represent the maximum percentage of time that controlled power is supplied to the elements. Do not attempt to "improve performance" by setting a value higher than the recommended values. To adjust the parameter refer to the "Changing the Maximum Output Power" of the control section of the manual.

Volts	110 V	200 V	208 V	220 V 380 V	230 V 400 V	240 V 415 V	254 V 440 V
Power (%)	87	100	98	87	80	73	65

Please refer to the rating label for product specific information.

## 11.0 Specifications

*Carbolite Gero reserves the right to change the specification without notice.*

Model	Max Temp (°C)	Max Power (kW)	External Size (mm)			Chamber Size (mm)			Net Weight (kg)
			H	W	D	H	W	D	
Ashing Burn-off and Coal and Coke Testing Furnace									
AAF 11/3	1100	2.1	585	375	485	90	150	250	22
with Thermal Catalytic Oxidiser Option	1100	2.1	740	375	670	90	150	250	25

### 11.1 Environment

The models listed in this manual contains electrical parts and should be stored and used in indoor conditions as follows:

Temperature: 5 °C - 40 °C

Relative humidity: Maximum 80 % up to 31 °C decreasing linearly to 50 % at 40 °C



# Notes

---

Dotted lines for taking notes.

## Service Record

Engineer Name	Date	Record of Work

ProductLabel

The products covered in this manual are only a small part of the wide range of ovens, chamber furnaces and tube furnaces manufactured by Carbolite Gero for laboratory and industrial use. For further details of our standard or custom built products please contact us at the address below, or ask your nearest stockist.

For preventive maintenance, repair and calibration of all furnace and oven products, please contact:

**Carbolite Gero Service**

Telephone: + 44 (0) 1433 624242

Fax: +44 (0) 1433 624243

Email: [ServiceUK@carbolite-gero.com](mailto:ServiceUK@carbolite-gero.com)

**Carbolite Gero Ltd,**

Parsons Lane, Hope, Hope Valley,  
S33 6RB, England.

Telephone: + 44 (0) 1433 620011

Fax: + 44 (0) 1433 621198

Email: [Info@carbolite-gero.com](mailto:Info@carbolite-gero.com)

[www.carbolite-gero.com](http://www.carbolite-gero.com)

**CARBOLITE**  
**GERO 30-3000°C**

Copyright © 2019 Carbolite Gero Limited