

### **Installation, Operation and Maintenance Instructions**

1100°C Ashing Furnace - AAF Model: 7 Litres

3508 Controller

AAF 11/7 + 3508 Controller

## Contents

This manual is for guidance on the use of the Carbolite Gero product specified on the front cover. This manual should be read thoroughly before unpacking and using the furnace or oven. The model details and serial number are shown on the back of this manual. Use the product for the purpose for which it is intended.

1.0	Symbols and Warnings .....	5
1.1	Switches and Lights .....	5
1.2	General Warnings .....	5
2.0	Installation .....	6
2.1	Unpacking and Handling .....	6
2.2	Siting and Setting Up .....	6
2.3	Chimney .....	7
2.4	Electrical Connections .....	8
3.0	3508 Controller .....	10
3.1	PID control .....	10
3.2	3508P1 .....	10
3.3	3508P10 .....	10
3.4	3508P25 .....	10
3.5	Basic Operation .....	11
3.5.1	Controller Layout .....	12
3.5.2	Keys .....	12
3.6	Quick Start Guide .....	12
3.6.1	Operation as a simple controller .....	12
3.6.2	Changing the Setpoint .....	12
3.6.3	Resetting the programmer .....	13
3.6.4	Understanding User Levels .....	13
3.7	Setting Up Controller .....	14
3.7.1	Maximum output power setting .....	14
3.7.2	Customer ID. ....	14
3.7.3	Units .....	15
3.7.4	Language .....	15
3.8	Programming .....	15
3.8.1	Programming Notes .....	15
3.8.2	Holdback .....	16
3.8.3	Wait Segments .....	16
3.8.4	Program Cycling .....	17
3.8.5	Creating a Program .....	17
3.8.6	Running a Program .....	18
3.8.7	To pause (hold) a program .....	19

3.8.8	To stop and reset a program .....	19
3.8.9	To run a different program (P10 and P25) .....	19
3.8.10	Program Status .....	19
3.8.11	Program Hold with Holdback .....	20
3.8.12	Power Failure Recovery .....	20
3.8.13	Alarms .....	21
3.8.14	Program Example 1 .....	21
3.8.15	Program Example 2 .....	23
3.9	Controller Options .....	25
3.9.1	Digital Communications - RS232 .....	26
3.9.2	Digital Communications - RS485 .....	26
3.9.3	Comms Address .....	26
3.9.4	Alarm Option .....	26
3.9.5	Remote Input and Output (Analogue Communications) .....	27
3.9.6	Program segment output .....	27
3.10	Temperature Controller Replacement .....	28
3.11	Controller Navigation Diagrams .....	28
3.11.1	Operator Level 1 - No Program Running .....	29
3.11.2	Operator Level 1 - Program Running .....	30
3.11.3	Supervisor Level 2 .....	31
4.0	3508 Dual Loop Cascade Control (if fitted) .....	32
4.1	Principle of Cascade Control .....	32
4.2	Operation of Cascade Control .....	32
4.3	Bypassing Cascade Control .....	36
4.4	3508P1 Element Loop (Loop 2) .....	36
4.5	Caution .....	36
4.6	Over-Temperature Control .....	36
5.0	2132 Over-Temperature Controller Description (if fitted) .....	37
5.1	Description .....	37
5.2	Operation .....	37
5.2.1	Controls .....	37
5.2.2	Operation .....	38
5.2.3	Over-Temperature Operation .....	38
5.2.4	Over-Temperature Alarm .....	38
5.2.5	Resetting the Over-Temperature Alarm .....	38
5.2.6	Sensor Break .....	38
5.3	Audible Alarm .....	39
5.4	Navigation Diagram .....	39

6.0	Operation .....	40
6.1	Operating Cycle .....	40
6.2	General Operating Notes .....	40
6.3	Use of Probes .....	41
6.4	Atmospheres .....	41
6.5	Operator Safety .....	41
6.6	Power Adjustment .....	42
7.0	Maintenance .....	43
7.1	General Maintenance .....	43
7.2	Maintenance Schedule .....	43
7.2.1	Cleaning .....	45
7.2.2	Safety Switch .....	45
7.3	Calibration .....	45
7.4	After-Sales Service .....	46
7.5	Recommended Spare Parts and Spare Parts Kit .....	46
8.0	Repairs and Replacements .....	47
8.1	Safety Warning - Disconnection from Power Supply .....	47
8.2	Safety Warning - Refractory Fibre Insulation .....	47
8.3	Temperature Controller Replacement .....	47
8.4	Solid-State Relay Replacement .....	48
8.5	Thermocouple Replacement .....	48
8.6	Element Replacement .....	49
8.7	Door Plug Replacement .....	51
8.8	Fuse Replacement .....	51
9.0	Fault Analysis .....	53
A.	Furnace Does Not Heat Up .....	53
B.	Product Overheats .....	54
10.0	Wiring Diagrams .....	55
10.1	WA-11-30 .....	55
10.2	WA-11-31 .....	56
10.3	WA-22-30 .....	57
11.0	Fuses and Power Settings .....	58
11.1	Fuses .....	58
11.2	Power Settings .....	58
12.0	Specifications .....	59
12.1	Environment .....	59

## 1.0 Symbols and Warnings

### 1.1 Switches and Lights



Instrument switch: when the instrument switch is operated the temperature control circuit is energised.



Heat light: the adjacent light glows or flashes to indicate that power is being supplied to the elements.

### 1.2 General Warnings



DANGER – Electric shock. Read any warning printed next to this symbol.  
WARNING: Risk of fatal injury.



DANGER – Hot surface. Read any warning printed next to this symbol.  
WARNING: All surfaces of a product may be hot.



DANGER – Read any warning printed next to this symbol.



Caution – Double Pole/Neutral Fusing

## 2.0 Installation

### 2.1 Unpacking and Handling

When unpacking and handling the product, always lift it by its base. Do not use the door or any other projecting cover or component to support the equipment when moving it. Use two or more people to carry the product where possible.

Carefully remove any packing material from inside and around the product before use. Avoid damaging the surrounding insulation when removing packing materials.



NOTE: This product contains Refractory Ceramic Fibre (also known as Alumino Silicate Wool - ASW). For precautions and advice on handling this material see section 8.2.

### 2.2 Siting and Setting Up

Place the product on a level surface in a well ventilated area.

Site away from other sources of heat and on a non-flammable surface that is resistant to accidental spillage or hot materials.

The surface on which the equipment is mounted should be stable and not subject to movement or vibrations.

The height of the mounting surface is important to avoid operator strain when loading and unloading samples.

Unless otherwise stated elsewhere in this manual, ensure that there is **at least 150 mm** of free space around the back and sides of the product. Clear space is required above the product to dissipate heat.

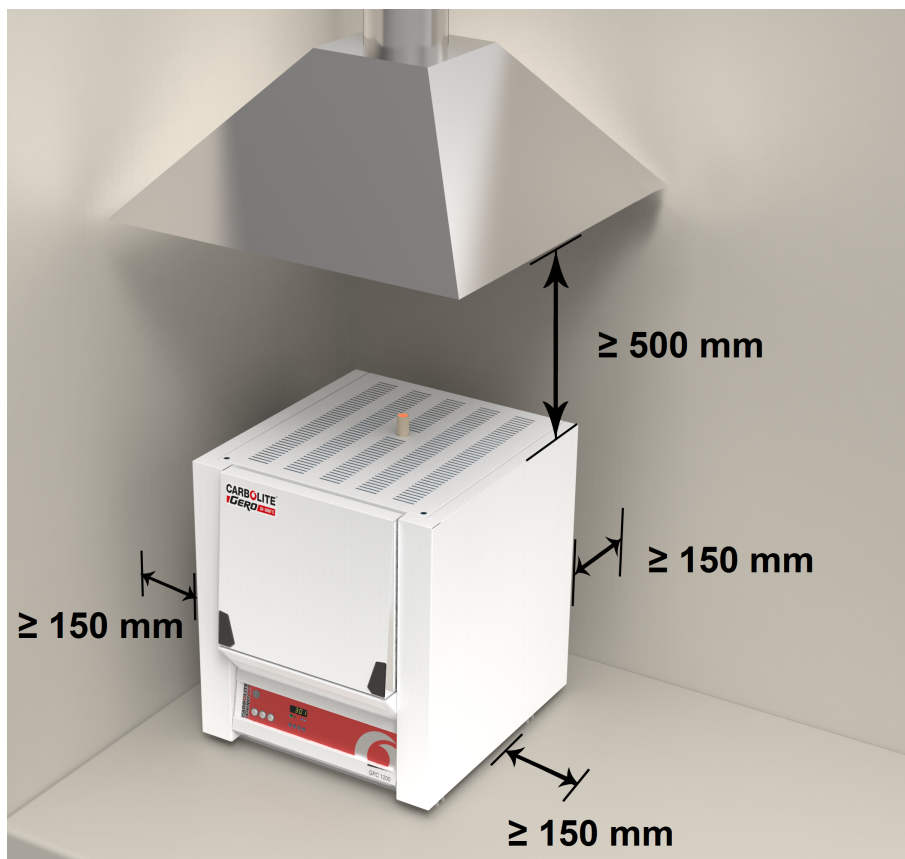

Depending on the application of the product, it may be appropriate to position it under an extraction hood. Ensure the extraction hood is switched on during use.

Ensure that the product is placed in such a way that it can be quickly switched off or disconnected from the electrical supply.



Under no circumstances should any objects be placed on top of the product. Always ensure that any vents on the top of the product are clear of any obstruction. Always ensure all cooling vents and cooling fans (if fitted) are clear of any obstruction.

### 2.3 Chimney

The chimney is a length of tubing. If it is supplied unfitted, then fit it through the hole in the top of the case.

If the product is to be used to heat substances that emit fumes, a fume extraction duct of approximately 75 mm - 150 mm inlet diameter may be placed directly above the chimney outlet.

Do not make a sealed connection to the product chimney as this causes excessive airflow through the chamber and results in poor temperature uniformity.

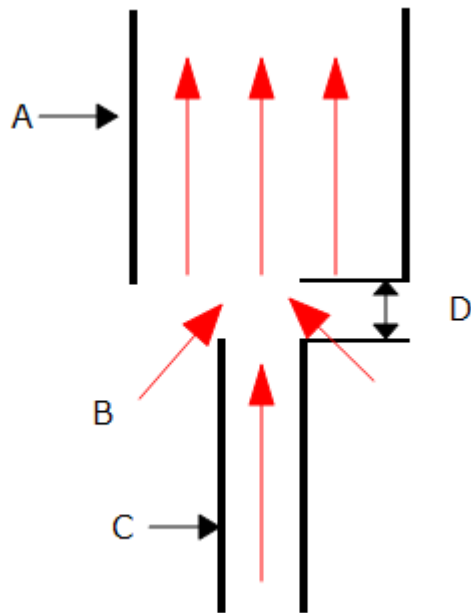

Key	
A	Duct (75mm-150mm diameter)
B	Ambient air is drawn into duct
C	Chimney
D	25mm vertical gap between chimney and duct

## 2.4 Electrical Connections



Connection by a qualified electrician is recommended.

This product requires a single-phase A.C. supply with earth (ground), which may be Live to Neutral non-reversible (polarised), Live to Neutral reversible (non-polarised), or Live to Live.

Check the product rating label before connection. The supply voltage should agree with the voltage on the label and the supply capacity should be sufficient for the current on the label.

The supply should be fused at the next size equal to, or higher than the current on the label. A table of the most common fuse ratings is also given towards the back of this manual. When the mains cable is factory fitted, internal fuses are also fitted. It is essential that the operator ensures that the product is correctly fused.

Products with a factory fitted supply cable are designed to be wired directly to an isolator or fitted with a line plug.

Products without a factory fitted supply cable require a permanent connection to a fused and isolated supply. The product's electrical access panel should be temporarily removed, and connections made to the internal terminals.

If the product is to be connected by line plug. The plug should be within reach of the operator and should be easy to remove.

When connecting the product to an isolating switch ensure that both conductors (single phase) or on all live conductors (three phase), and should be within reach of the operator.

The supply **MUST** incorporate an earth (ground).



Electrical Connection Details:

Supply	Terminal Label	Cable Colour	Supply Types	
			Live - Neutral	Reversible or Live-Live
1-phase	L	Brown	to live	to either power conductor (For USA 200-240V, connect L1)
	N	Blue	to neutral	to the other power conductor (For USA 200-240V, connect L2)
	PE	Green/ Yellow	to earth (ground)	to earth (ground)

## **3.0 3508 Controller**

### **3.1 PID control**

This controller uses PID (Proportional Integral Derivative) temperature control. This type of control uses a complex mathematical control system to adjust the heating power and achieve the desired temperature.

### **3.2 3508P1**

The 3508P1 is a digital temperature controller which uses PID algorithm to give excellent temperature control when properly set. This controller can store and operate a single program of up to 20 segments. The 3508P1 can also be used as a simple temperature controller.

### **3.3 3508P10**

The 3508P10 is a digital controller which uses PID algorithms to give excellent temperature control when properly set. This controller can store 10 programs of up to 50 segments each. Programs can be operated individually or linked by a Call parameter as sub-programs or to form single long programs. The 3508P10 can also be used as a simple temperature controller.

### **3.4 3508P25**

The 3508P25 is a digital temperature controller which uses PID algorithms to give excellent temperature control when properly set. This controller has a maximum of 500 segments or 25 programs; each program has a maximum of 50 segments. For example 3508P25 could store 10 programs with 50 segments or 25 programs with 20 segments. Programs can be operated individually or linked by a Call parameter as sub-programs or to form single long programs. The 3508P25 can also be used as a simple temperature controller.

### 3.5 Basic Operation

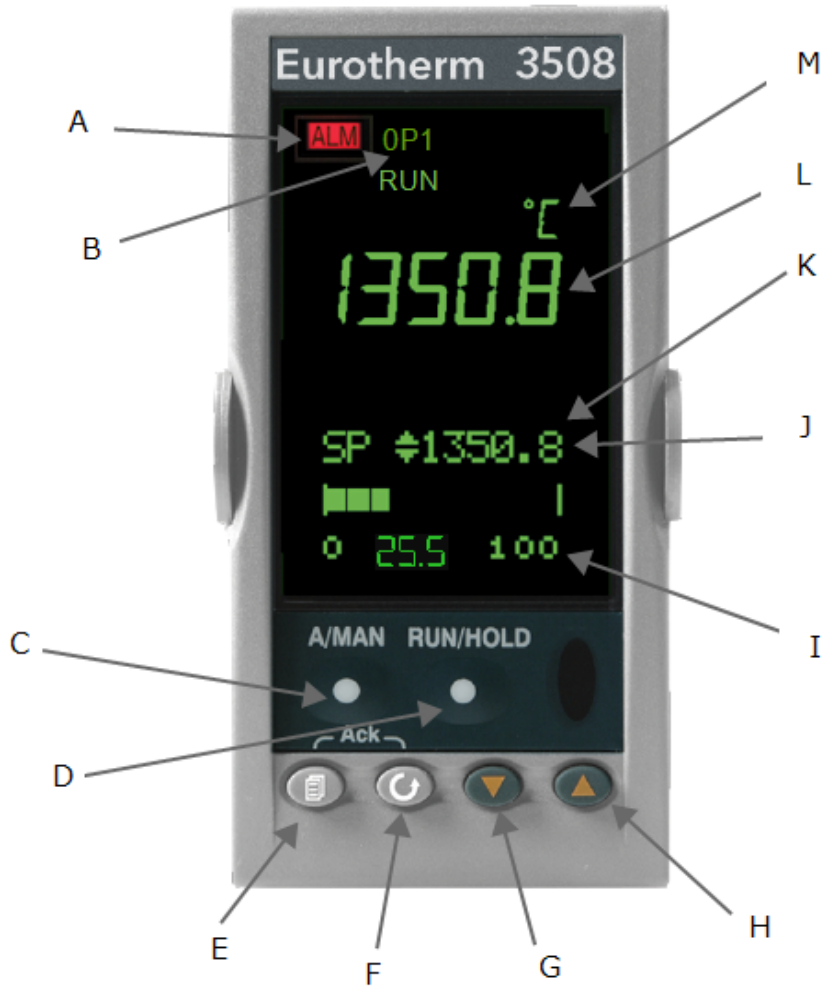

Key	
A	Alarm Indicator
B	Power Output Indicator
C	Not Used
D	Runs, Holds, Resets the current program
E	Page
F	Scroll
G	Down
H	Up
I	Power Output Percentage
J	Program Setpoint Temperature (PSP) when a program is running
K	Setpoint Temperature (SP) when basic controlling
L	Measurement Temperature

M	Measurement Units
---	-------------------

### 3.5.1 Controller Layout

### 3.5.2 Keys

A/ Man	-	Disabled
RUN/ HOLD	-	Runs, Holds or Resets the current program. Hold down for 3 seconds to Reset.
Page Key		Scrolls through the page headings. Hold down for 3 seconds to access further levels, pass codes are required.
Scroll Key		Scrolls through parameters listed on pages.
Arrow Keys		Adjust parameter values.
Page and Scroll together		Press together to return to the home display or to acknowledge an alarm.
Page and Up together		Press together quickly to scroll back up the page headings.
Scroll and Up together		Press together quickly to scroll back up a parameter list.
Pressing any other combination of keys together has no effect.		

Note: If no keys are pressed for 1 minute, the display returns to Home.

## 3.6 Quick Start Guide

### 3.6.1 Operation as a simple controller

When switched on the controller goes through a short test routine and then shows the measured temperature. Below it, the setpoint temperature (SP) and percentage of power output.

The controller will immediately attempt to reach the set temperature and maintain it. This will cause the product to heat as quickly as possible which may not be appropriate where the product contains sensitive ceramic components. For products with ceramic components, e.g. a tube furnaces fitted with a long ceramic work tube, use the ramp rate feature set with a low heating rate such as 5°C per minute (300°C per hour), to prevent damage.

### 3.6.2 Changing the Setpoint

Press up or down to select the required SP. If the SP is higher than the measured temperature, the OP1 indicator will illuminate at the top of the display, indicating that the product is heating.

The controller will immediately attempt to reach the set temperature and maintain it.

This will cause the product to heat as quickly as possible which may not be appropriate where the product contains sensitive ceramic components. For products with ceramic components, e.g. a tube furnaces fitted with a long ceramic work tube, use the ramp rate feature set with a low heating rate such as 5°C per minute (300°C per hour), to prevent damage.

### 3.6.3 Resetting the programmer

To reset the programmer to simple controller mode, press RUN/HOLD for 2 seconds.

#### **Operating the current program**

- To avoid unwanted heating at the end of a program, set the SP temperature to zero before operating a program.
- Ensure the programmer is reset to simple controller mode before starting a program by pressing RUN/HOLD for 2 seconds.
- To start the program, press RUN/HOLD twice, RUN will light up on the display.

The displayed Program Setpoint (PSP) follows ramps, dwells and steps as the program runs. The SP temperature of the controller does not apply when a program is operating.

- To pause the program, press RUN/HOLD.
- To stop the program and return to simple controlling (reset), press RUN/HOLD for 2 seconds.

When the program ends, the programmer will either:

- Automatically reset to operation as a simple controller.
- Dwell at the last temperature of the program (with the RUN indicator flashing), until the operator presses RUN/HOLD for 2 seconds to manually reset, or presses RUN/HOLD once to restart the program.
- Turn power to the elements down to zero.





### 3.6.4 Understanding User Levels

There are two levels in the controller; Level 1(Operator) and Level 2 (Supervisor).

Level 1 (Operator) is for the day-to-day operation of the controller is not protected by a security code. There are 3 pages at this level. Page 1, Customer Identity, can only be altered in level 2. Page 2 shows the current program status. Page 3 is for writing and viewing programs.



Level 2 (Supervisor) requires a security code to enter, but once enable, provides access to additional parameters. A further 4 pages are accessible in this level as follows; Home , Customer identity, Control Output Hi percentage, Units.

To Enter Level 2:

1. Press and hold page  for 3 seconds. The display will show "Access Goto Level 1"
2. Press up  to select level 2. After a short pause the display will show "Access Pass code".
3. Press up  or down  to enter the pass code. Pass is momentarily displayed. After a short pause the display will return to home, the controller is now in level 2.

When Level 2 operations have been completed the supervisor must return to Level 1 manually. It is not necessary to enter a code when going from a higher level to a lower level.

To Return to Level 1:

1. Press and hold page  for 3 seconds. The display will show "Access Goto Level 2."
2. Press down  to go to level 1. After a short pause the display will revert to home, the controller is now in level 1.

### 3.7 Setting Up Controller

Before using the controller (or during its lifetime) certain parameters may have to be set, depending on specific requirements. To do this the controller must be set to Supervisor Level 2, see "Controller Navigation Diagrams".

#### 3.7.1 Maximum output power setting

Press page  until "Control Output Hi" is displayed. Press up  or down  to adjust the value.



Depending on the product model, the maximum power output setting may be accessible or locked.

For silicon carbide heated products the parameter is accessible to allow compensation for element ageing.



In many models the maximum power output setting depends on the electrical supply voltage, refer to section 11.0.

#### 3.7.2 Customer ID.

A product identity number can be entered if required. This may be used to identify one of many units, for production or quality control systems.

Press page  until "Customer Identity" is displayed. Press up  or down  to select a number.

### 3.7.3 Units

Press page  until "Units" is displayed. Press up  or down  to select:

C	Celsius
F	Fahrenheit
K	Kelvin

### 3.7.4 Language

The text on the 3508 Controller can be shown in different languages, this can only be set at the factory and therefore must be specified at the time of placing an order.

## 3.8 Programming

### 3.8.1 Programming Notes

Programs can be created in Level 1 or Level 2 of the 3508 Controller.

For the P10 and P25, new programs can be created while the current program is operating.

To avoid unwanted heating at the end of a program, set the controller setpoint temperature to zero before operating a program.

All new unused programs show only 1 segment of type 'End'.

The minimum number of segments for a program is 2. The second being an 'End' type.

Ramp-to-setpoint control. To achieve this, create a two segment program. Set the first segment type as 'Rate' or 'Time'. Set the second segment type 'End' type 'Dwell'.

For the P10 and P25, programs can be linked together using a 'Call' segment. However, a lower number program can not be called and a program can not be ended with a call segment.

A program can be ended in four ways:

1. With 'End' segment set to S.OP the power to the elements is turned down to 0%, no matter what the 'Setpoint' temperature is.
2. With 'End' segment set to 'Reset' and the 'Setpoint' temperature turned down to zero, power to the elements will be 0%. To do this set the 'Setpoint' temperature to the minimum possible. For type B thermocouples this will be below zero.
3. With the 'End' segment set to 'Reset'. The controller will try to reach and maintain the 'Setpoint' temperature in place before the program started.
4. With the 'End' segment set to 'Dwell'. The controller will dwell at the 'PSP' of the last segment ("RUN" indicator flashes), until it is reset.

To reduce the number of segments in a program, change the last required segment to an 'End' type.

You will be asked to press  to cancel or  for OK.





To cancel all segments in a program, change the first segment to an 'End' type.

To alter parameters or segments of an operating program, this program must be held or reset. Press RUN/ HOLD to pause the program, or press RUN/ HOLD for 2 seconds to reset.

### 3.8.2 Holdback

Holdback can be used to prevent the program from operating ahead of the actual heating or cooling.

The holdback value is the amount, in degrees, by which the program setpoint can run ahead of the measured temperature before holdback operates. The value applies to a whole program.





To set the value press page  twice, press scroll  until 'Holdback Value' appears and press up  or down  to set.

Holdback can be used in 'Rate', 'Time' and 'Step' segments.

- For 'Rate' and 'Time' segments holdback will operate during the segment.
- For a 'Step' segment holdback delays continuation to the next segment until the step target is reached.

The 'Holdback Type' can be set as follows:

• Low	Applies to heating only
• High	Applies to cooling only
• Band	Applies to both heating and cooling
• Off	Holdback is switched off

To set the holdback type, press page  twice, then press scroll  until the display shows 'Holdback Type' for each segment and press up  or down  to set.

The default setting for holdback is 'OFF'.

### 3.8.3 Wait Segments

Wait prevents the program proceeding to the next segment, in a similar way to holdback, until the selected 'Wait-For' parameter has been met. There are 5 'Wait For' parameters. The first 4 only work if there are configured inputs to the controller.

1. PrgIn1 Wait until Input 1 is true
2. PrgIn2 Wait until Input 2 is true
3. PrgIn 1&2 Wait until Inputs 1 AND 2 are true
4. PrgIn 1or2 Wait until Inputs 1 OR 2 is true
5. PVWaitIP Wait until the measured temperature reaches a threshold value before continuing. It can operate in one of 4 ways:
  1. 'Abs Hi' Wait until the measured temperature is greater than or equal to a value 'WaitVal' set for that segment.
  2. 'Abs Lo' Wait until the measured temperature is less than or equal to a value 'WaitVal' set for that segment.







3. 'Dev Hi' Wait until the measured temperature exceeds a fixed\* threshold by an amount 'WaitVal' set for that segment.
4. 'Dev Lo' Wait until the measured temperature drops below a fixed\* threshold by an amount 'WaitVal' set for that segment.

\* The fixed threshold used by deviation parameters is set in the configuration level of the programmer and if required should be requested when purchasing a product from Carbolite Gero.



### 3.8.4 Program Cycling

The 'Cycles' parameter sets the number of times the program will operate.

The default setting is 1 cycle.

To change the number of cycles, press page  twice, then press scroll  until the display shows 'Prog Cycles', then press up  to set a finite number of cycles up to 999. Or press down  to set cycling to continuous.



### 3.8.5 Creating a Program

From the home display, press page  three times to get to the programming page, the display will show "ProgEdit   1".

#### Program number

On P10 or P25 models press up  or down  to select a new program number. The display will show that new programs have only one segment.

#### Holdback Value



Press scroll  until the display shows 'Holdback Value". If required: Press up  or down  to set a value. This value will be used in any segment where a 'Holdback Type' is set.

#### Ramp Units

These apply to Rate segments only. Press scroll until the display shows 'Ramp Units'.

Press up  or down  to select the ramp units of degrees per Hour, Min or Sec.

#### Number of program cycles



Press scroll  until the display shows 'Cycles'. Press up  or down  to select more than one cycle.

Now create all the segments for your program, finishing with an 'End' segment. When parameters for each segment have been entered the display goes to the next segment number.

#### Segment Type

Press scroll  until the display shows 'Segment Type'. Press up  or down  to select 'Rate', 'Time', 'Dwell', 'Step', 'Wait', 'GoBack', 'Call' or 'End'.



### Holdback Type

Press scroll  until the display shows 'Holdback Type'. If required, press up  or down  to select 'Off', 'Low', 'High' or 'Band'.



### Target Setpoint (Visible only for Rate, Time and Step segments)

Press scroll  until the display shows 'Target SP'. Press up  or down  to set a value.



### Ramp Rate (Visible only for Rate segments)

Press scroll  until the display shows 'Ramp Rate'. Press up  or down  to set the number of degrees per 'Ramp Unit' as set above.



### Duration (Visible only for Time and Dwell segments)

Press scroll  until the display shows 'Duration". Press up  or down  to set a value.

### Wait For (Visible only for Wait segments)

Press scroll  until the display shows 'Wait For'. Press up  or down  to select: PrgIn1, PrgIn2, PrgIn1In2, PrgIn1orIn2, PVWaitIP.

### GoBack to segment number (visible only for GoBack segments)

Press scroll  until the display shows 'GoBack Seg'. Press down  to select a segment number to go back to.



### GoBack Cycles (visible only for GoBack segments)

Press scroll  until the display shows 'GoBack Cycles'. Press up  or down  to set a value.





### Call Cycles (Visible only for call segments)

Press scroll  until the display shows 'Call Cycles'. Press up  or down  to set a value.

### End Type (Visible only for End segments)

Press scroll  until the display shows 'End Type'. Press up  or down  to select: 'Reset', 'Dwell' or 'SafeOp'.

#### 3.8.6 Running a Program

The current program can be started from the home display by pressing RUN/HOLD or by pressing page  once, then scroll  once (twice for P10 and P25), then press up  or down  to change the status to 'Run'.

### 3.8.7 To pause (hold) a program

Press RUN/HOLD

or

Press page  until 'Program Status Reset' appears

Press scroll  until the cursor moves to 'Reset'

Press up  or down  to select 'Hold'

RUN/HLD will be displayed

### 3.8.8 To stop and reset a program

Press and hold RUN/HOLD

or

Press page  until 'Program Status Reset' appears

Press scroll  until the cursor moves to 'Reset'

Press up  or down  to select 'Reset'

### 3.8.9 To run a different program (P10 and P25)

To select a program

Press page  until 'Program Status Reset' appears



Press scroll  then up  or down  to select a program number

To operate the program

Press RUN/HOLD

or

Press scroll  until the cursor moves to 'Reset'

Press up  or down  to select 'Run'

Run will be displayed

### 3.8.10 Program Status

While a program is operating the home display shows 3 values:







- Top: Measured temperature
- Centre: Program Setpoint (PSP)
- Bottom: Power output percentage

To see more detail:

Press page  once to go to the program status page. The top and centre values from the home page remain on the display. The lower half of the screen now shows:

- Current program number (P10 and P25 only)
- Current segment number
- Time remaining for that segment

Further presses of the scroll  key while a program is operating will reveal additional information:

-  Status. This can be changed to 'Hold', 'Reset' or 'Run' by pressing up ▲ or down ▼
-  Program Setpoint (PSP)
-  Current Segment Type. 'Step' and 'Call' segments are instant, so are only flashed on the screen, unless holdback is operating on that segment.
-  Target Setpoint
-  Segment Rate For 'Rate', 'Time' and 'Step' segments only
-  Cycles left
-  Program Time Left

#### 3.8.11 Program Hold with Holdback

If a holdback value has been set and the program goes into a hold state, the green HLD indicator will flash until the measured temperature catches up.

While in this condition, the program itself is put into hold by pressing the RUN/HLD button, the 'HLD' indicator will stop flashing and remain on with the 'RUN' indicator. When the program is started again by pressing the RUN/HLD button, the 'HLD' indicator will flash again if the measured temperature has not caught up with the program.

Programming note: For P10 and P25 models, other programs can be created or changed whilst the current program is operating.

#### 3.8.12 Power Failure Recovery

If there is a power interruption to the controller during a program, when power is restored the controller pauses the program, then ramps the temperature back up to the current program setpoint (PSP) before continuing the program.

- Power failure during ramp segments: The ramp rate will be that of the current ramp segment.
- Power failure during dwell segments: The ramp rate will be that of the previous ramp segment. If a previous ramp segment does not exist, then the dwell will continue at the current measured temperature.
- Power failure during time-to-target segments: The ramp rate will be that of the current segment. The ramp rate is maintained, but the time remaining is recalculated.

If there is a power interruption while controlling to setpoint, when power is restored the controller automatically calls for maximum power.

### 3.8.13 Alarms

Alarms are used to alert the operator when a pre-set level has been exceeded or a function error has occurred such as a sensor break. They are indicated by a flashing red ALM (Alarm) indicator. The alarm may also switch an output – usually a relay to allow external devices to operate when an alarm occurs. Alarms only operate if they have been configured and are dependent on customer requirements.





















How to acknowledge an alarm will depend on the type of latching which has been configured. A non-latched alarm will reset itself when the alarm condition is removed. A latched alarm requires acknowledgement with the 'ACK' function before it is reset.

If an alarm has been activated, the red 'ALM' indicator will flash and the text will indicate the type of alarm.

To acknowledge an alarm and cancel the 'ALM' indicator, press  and  together.

### 3.8.14 Program Example 1

The following sequence of entries creates and runs the program shown graphically below.

1. Turn the controller SP down to '0' by pressing down .
2. Press page  until 'Prog Segments Used' is displayed. On P10 or P25 models press up  or down  to select a new program number, (a program with only 1 segment).
3. Press scroll  until 'Holdback Value' is displayed. Default '0' degrees.
4. Press scroll  until 'Ramp Units' is displayed. Press up  or down  to set to 'Min'
5. Press scroll  until 'Cycles' is displayed. Default '1'
6. Press scroll  until 'Segment 1' is displayed
7. Press scroll  until 'Segment Type' is displayed. Press up  or down  to select 'Rate'
8. Press scroll  until 'Holdback Type' is displayed. Default 'Off'
9. Press scroll  until 'Target SP' is displayed. Press up  or down  to set to '400' degrees.
10. Press scroll  until 'Ramp Rate' is displayed. Press up  or down  to set to '5.0' degrees per minute.

Repeat steps 6 to 10 for 4 more segments. Set 'Holdback' to the default 'Off'. Enter the following parameters and values:











Segment Type Dwell Duration `30:00.0` minutes

Segment Type Step Target SP `600` degrees

Segment Type Dwell Duration `30:00.0` minutes

Segment Type Time Target SP `200` degrees, Duration `2:00:0` hours

Finish the program with an 'End' segment:

11. Press scroll  until 'Segment Type' is displayed. Press up  or down  to select 'End'
12. Press scroll  until 'End Type' is displayed. Press up  or down  to select 'Reset'
13. Press page  and scroll  together to return to the home display.  
To run the program either press RUN/HOLD or:
14. Press page  until 'Program Status' is displayed
15. Press scroll  until the cursor moves to the program status of 'Reset'
16. Press  to select 'Run'.

**Time Display Examples**

10:05:3 Min/Sec/10th Sec

21:10:05 Hour/Min/Sec

196:10 Hour/Min

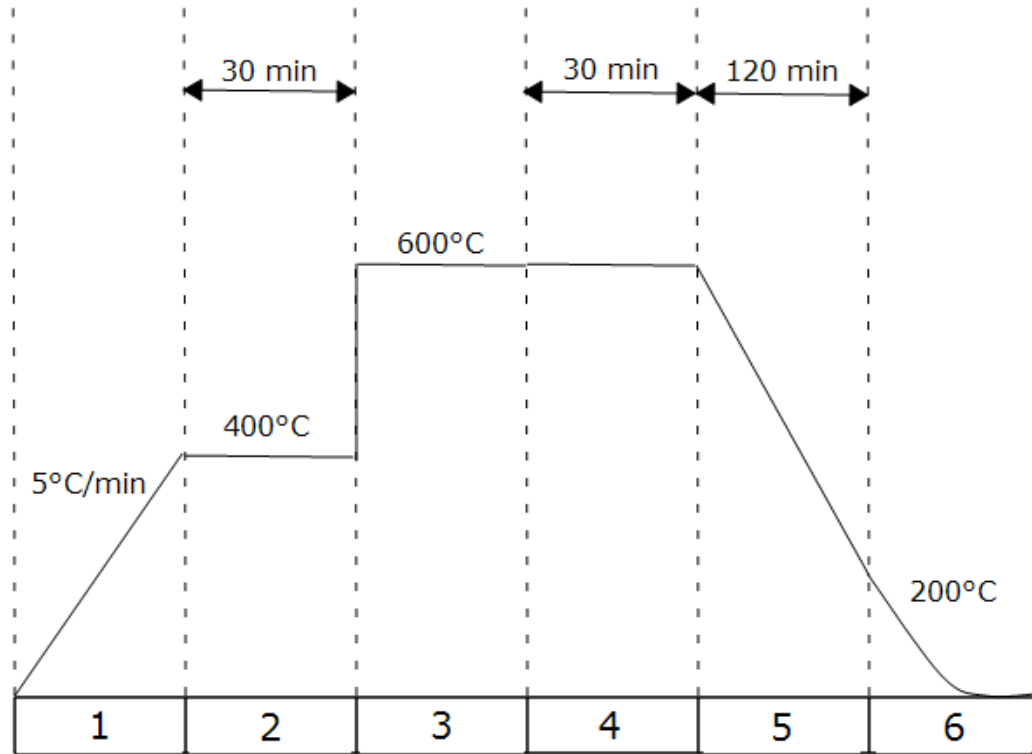













Segment					
1	2	3	4	5	6
Type 'Rate'	Type 'Dwell'	Type 'Step'	Type 'Dwell'	Type 'Time'	Type 'End'
Target 400°C	Duration 30 min	Target 600°	Duration 30 min	Target 200°	End Type 'Reset'
Rate 5.0°/Min				Time 120 min	

3.8.15 Program Example 2

The following sequence of entries creates and runs the program shown graphically below.











1. Turn the 'Setpoint' to '0' by pressing down ▼
2. Press page [P] until 'Prog Segments Used' is displayed. On P10 and P25 models press up ▲ or down ▼ to select a new program number, (a program with only 1 segment).
3. Press scroll [G] until 'Holdback Value' is displayed. Press up ▲ or down ▼ to set to '5' degrees
4. Press scroll [G] until 'Ramp Units' is displayed. Press up ▲ or down ▼ to set to 'Min'

5. Press scroll  until 'Cycles' is displayed. Default '1'
6. Press scroll  until 'Segment 1' is displayed
7. Press scroll  until 'Segment Type' is displayed. Press up  or down  to select 'Time'
8. Press scroll  until 'Holdback Type' is displayed. Default 'Off'
9. Press scroll  until 'Target SP' is displayed. Press up  or down  to set to '600' degrees
10. Press scroll  until 'Duration' is displayed. Press up  or down  to set to '30:00.0' minutes

Repeat steps 6 to 10 for 4 more segments. Enter the following parameters and values:  
 Note: Call segments are not available on single program models.

Segment Type Rate	Target SP '400' degrees. Ramp Rate '2.0' degrees per minute
Segment Type Step	Target SP '200' degrees
Segment Type Dwell	Holdback 'High'. Duration '30:00.0' minutes
Segment Type Call	Call Prog 'next number'. Call Cycles '2'

Finish the program with an End segment:

11. Press scroll  until 'Segment Type' is displayed. Press up  or down  to select 'End'
12. Press scroll  until 'End Type' is displayed. Press up  or down  to select 'Dwell'  
 Repeat the sequence to create a short program '3' as suggested in the diagram.
13. Press page  and scroll  together to return to the home display  
 To operate the program either press RUN/HOLD or
14. Press page  until 'Program Status' is displayed
15. Press scroll  until the cursor moves to the program status of 'Reset'
16. Press  to select 'Run'



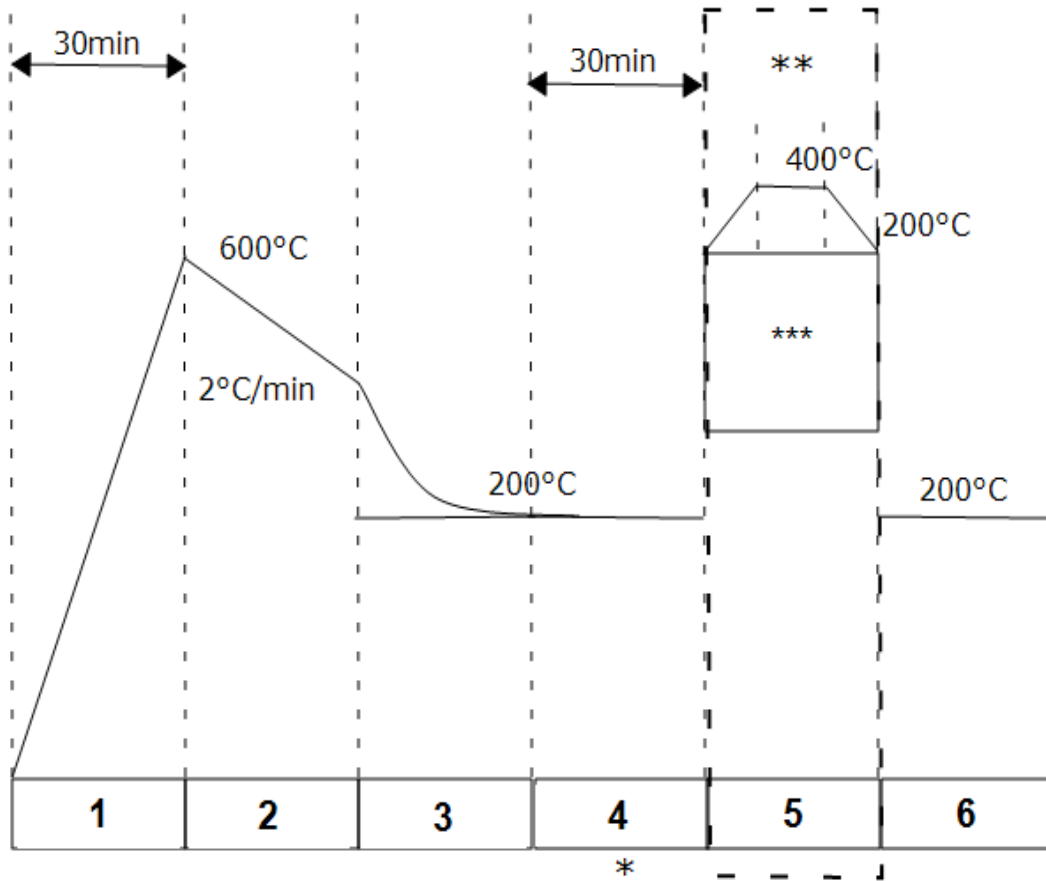

Segment					
1	2	3	4	5	6
Type 'Time'	Type 'Rate'	Type 'Step'	Type 'Dwell'	Type 'Call'	Type 'End'
Target 600°C	Target 400°C	Target 200°C	Duration 30 min	Call prog 3	End Type 'Dwell'
Duration 30min	Rate 2°C/min		H back type 'High'	Call cycles 2n	
			* Segment 4 'Holdback Value' 5°C	** P10 and P25 only	
				*** Program 3 Example	

### 3.9 Controller Options

As options can be ordered in a variety of combinations and for a variety of purposes, exact instructions are not given here. The full Eurotherm manual may be required to determine customer parameter settings. To reveal or hide parameters in the controllers it is necessary to go into configuration mode, a security code is needed. Please consult Carbolite Gero.

### 3.9.1 Digital Communications - RS232

If the RS232 option is supplied, the furnace is fitted with one sub-miniature D-socket connected to the controller comms module. RS232 is suitable for direct connection to a personal computer (PC) using a "straight through" cable as follows (the linked pins at the computer end are recommended but may not be necessary). The cable is usually 9-pin at the furnace end and 9-pin at the computer, but other alternatives are shown in parentheses.

Product end of cable female (25-pin) 9-pin			<b>RS232 Cable: product to PC</b>	Computer end of cable 9-pin (25-pin) male		
Rx	(2)	3	_____	3	(2)	Tx
Tx	(3)	2	_____	2	(3)	Rx
Com	(7)	5	_____	5	(7)	Com
				7,8 1,4,6	(4,5) (6,8,20)	Link together Link together

### 3.9.2 Digital Communications - RS485

If an RS485 option is supplied, the furnace is fitted with two D-sockets. Connection between products is by "straight" cable as follows:

Product end of cable female (25-pin) 9-pin			<b>RS485 Cable: product to PC</b>	Computer end of cable 9-pin (25-pin) female		
-	(2)	3	=====	3	(2)	Tx
+	(3)	2		2	(3)	Rx
Com	(7)	5	_____	5	(7)	Com

### 3.9.3 Comms Address

Typically the comms address is set to 1, but this can be changed. In the case of RS485 and multiple instruments it is necessary to set different addresses. To change the address value, access the level 2 list. In level 2 press the page key until the COMMS parameter is displayed. Press up ▲ down ▼ to select the address value.

### 3.9.4 Alarm Option

When an alarm board is fitted, which consists of a relay with voltage free contacts, for operator use, the contacts are taken to a panel plug on the control panel, wired as indicated:

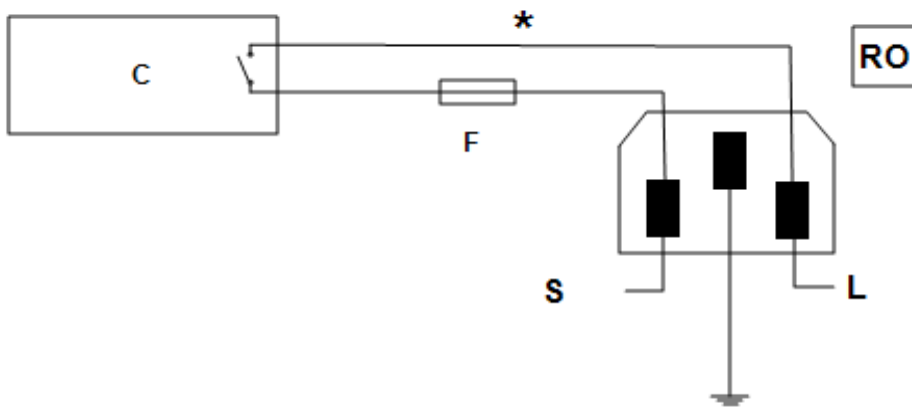

Key	
C	Temperature Controller
F	Fuse (2A)
S	Supply
L	Load
*	Normally open relay contacts
RO	Relay Output 240V 2A MAX

The purpose of the 2 amp fuse is to break the circuit to prevent overloading on the circuit due to high voltage.

The instrument configuration and parameters available to the operator depend on the customer requirements.

### 3.9.5 Remote Input and Output (Analogue Communications)

When analogue communications are fitted, the contacts are taken to insulated terminal sockets on the control panel.

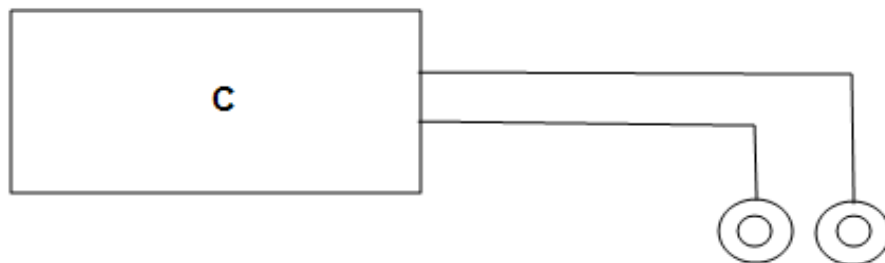

Key	
C	Controller

Controller configuration depends on customer requirements.

Remote input (when specified) may be switched on and off using the remote setpoint enable parameter in the controller level 2, if this was made available for a particular application. In level 2 press page until 'REM SP Enable' is displayed, press up or down to select SP1 (the normal controller setpoint) or SP2 (the remote input setpoint), 'SPX' will appear in the top left corner of the display.

Remote output does not require switching on and off.

### 3.9.6 Program segment output

When the customer requirement is for program segment output, an extra parameter is revealed in the PROG list. For each program segment, after the segment type and settings, the parameter EVENT OUTS appears. This has values on and off. If the value

is set to on, then the relay closes during the segment and a small 1 appears in the top left of the screen.

If more than one program segment output is fitted, then there are extra boxes depending on how many event outputs there are.

### 3.10 Temperature Controller Replacement



Before handling the controller: wear an anti-static wrist strap or otherwise avoid any possibility of damage to the unit by static electricity. Refer to the detailed instructions supplied with the replacement controller.

Ease apart the two lugs at the side; grip the instrument and withdraw it from its sleeve; push in the replacement.

### 3.11 Controller Navigation Diagrams

The following diagrams detail how to navigate to the various menu options within the 3508 Controller. At each option, values can be set using the arrow keys.

3.11.1 Operator Level 1 - No Program Running

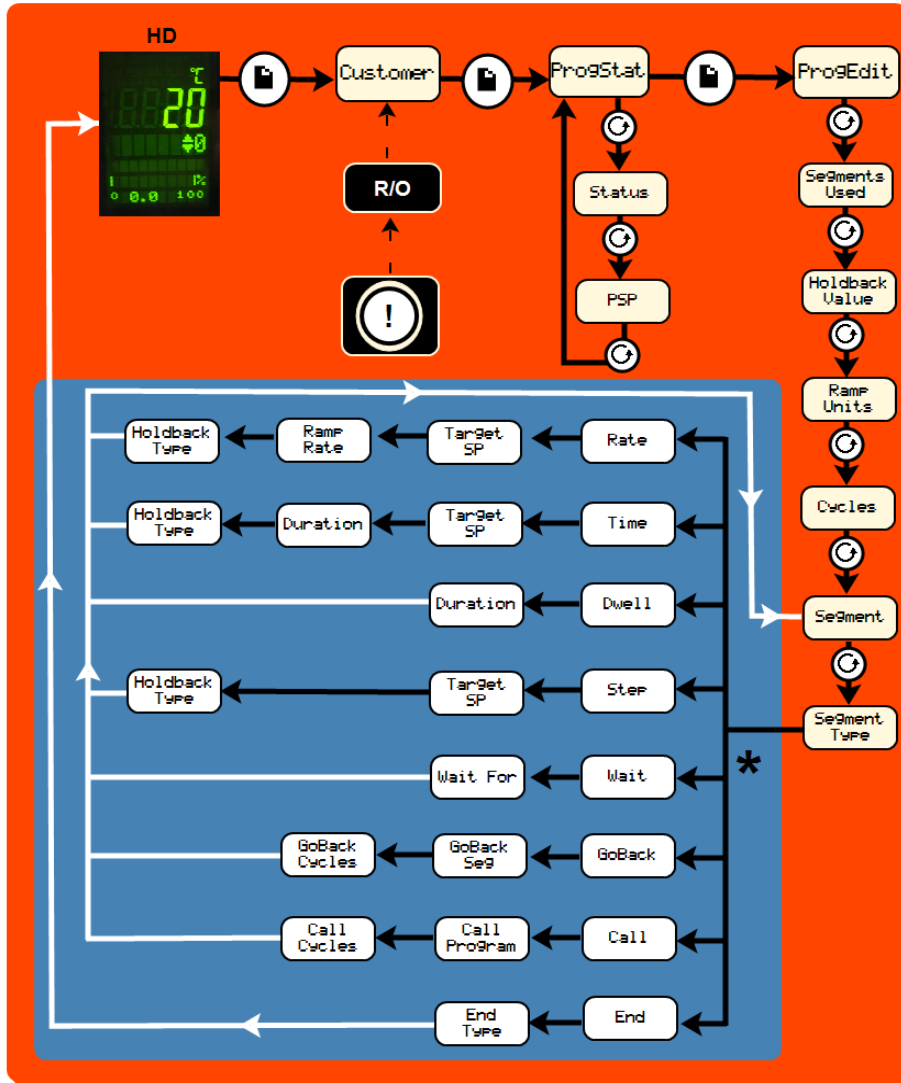

<b>HD</b>	Home Display	!	Controller identity when using more than one controller
<b>R/O</b>	Read Only		Black = Progress
	Page Key	→	White = Return
	Scroll Key	*	Visible Parameters depend on the Segment Type

3.11.2 Operator Level 1 - Program Running

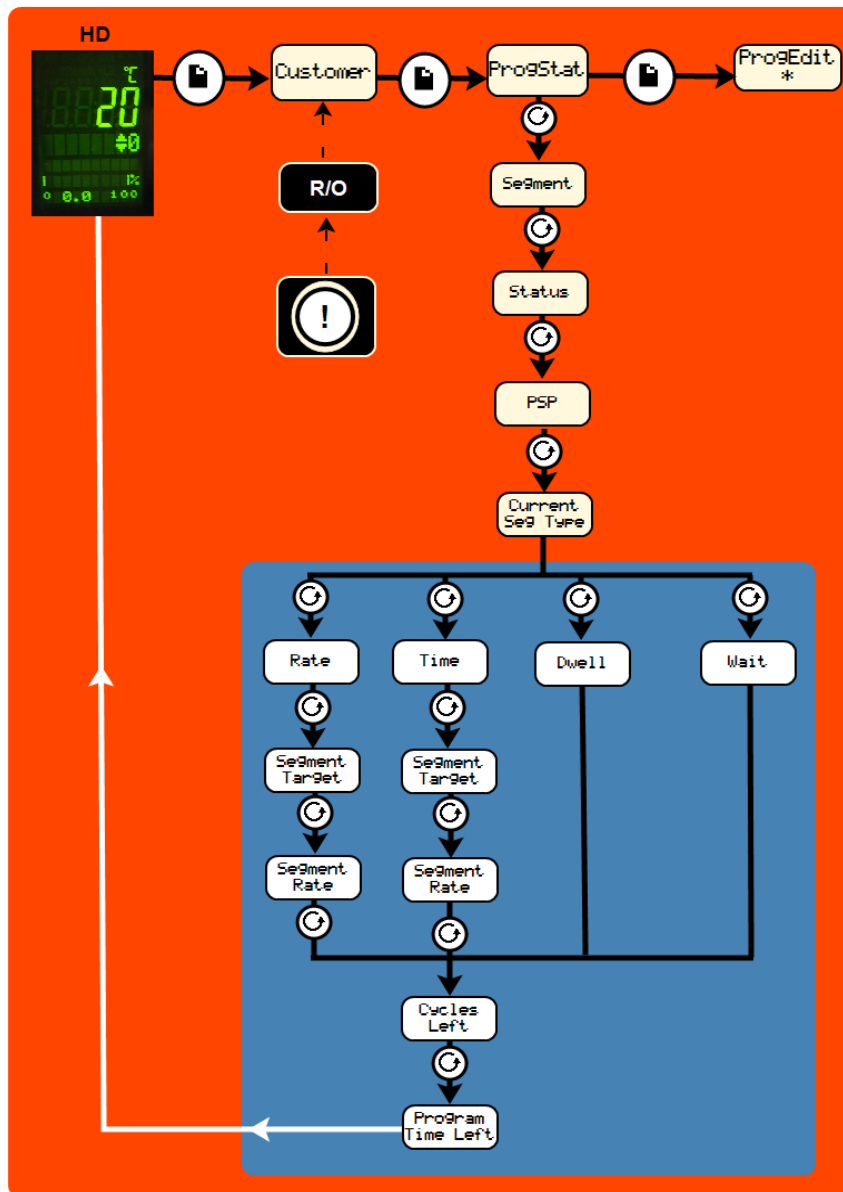

<b>HD</b>	Home Display	!	Controller identity when using more than one controller
<b>R/O</b>	Read Only	→	Black = Progress
	Page Key	*	White = Return
	Scroll Key	*	See previous diagram: Operator Level 1- No Program Running

### 3.11.3 Supervisor Level 2

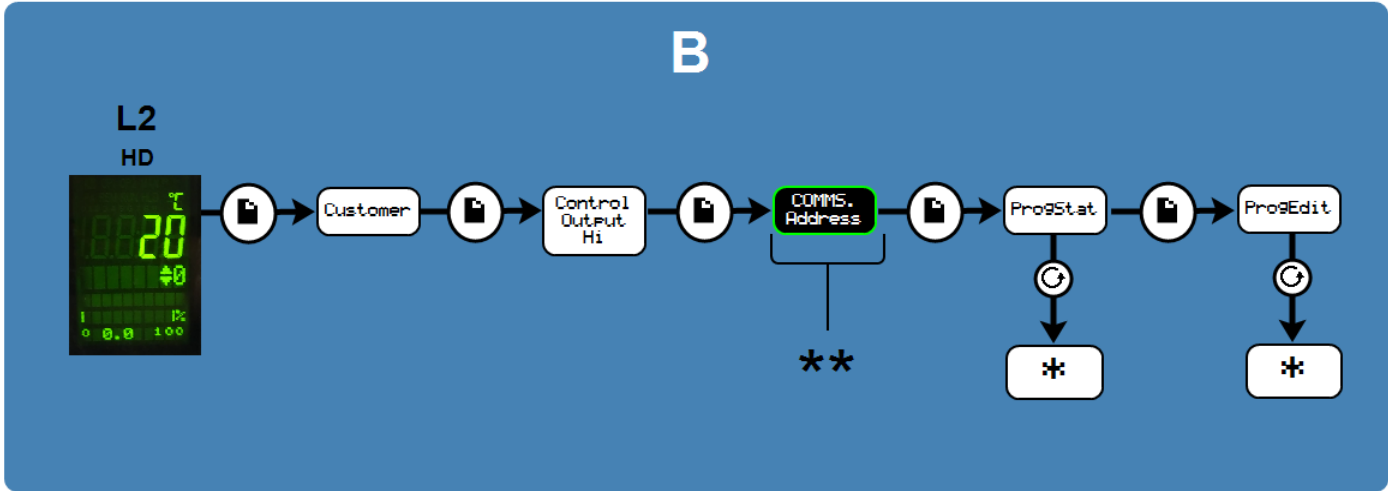
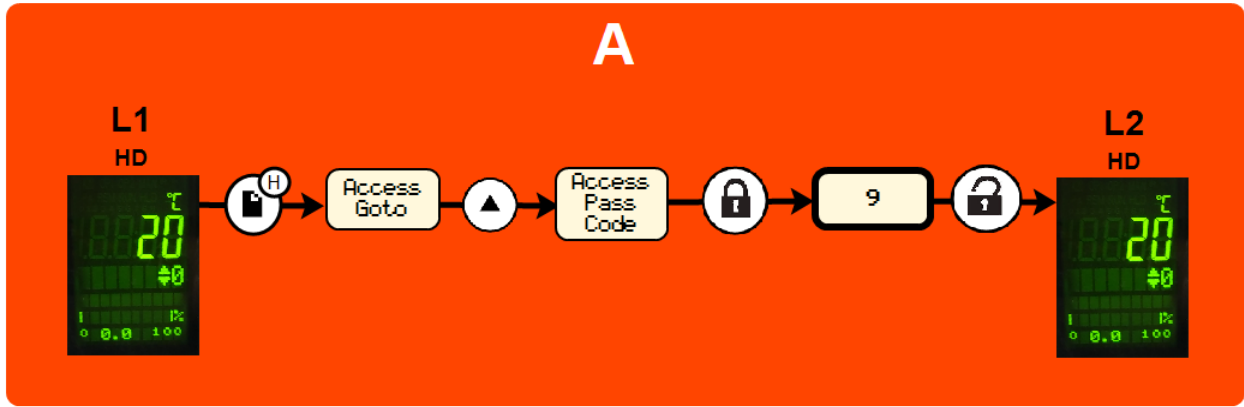

A	To enter Level 2		Scroll Key
B	Level 2		Locked before Pass Code entered
L1	Level 1 Home Display		Unlocked
L2	Level 2 Home Display		Black = Progress
	Page Key		See previous diagram: <b>Operator Level 1- No Program Running</b>
	Hold Page Key for 3 seconds		If configured
	Arrow Key		

## 4.0 3508 Dual Loop Cascade Control (if fitted)

### 4.1 Principle of Cascade Control

When cascade control is fitted, the Load Loop 3508 senses the temperature of the workload, and the Element Loop 3508 senses the element temperature. Depending on the oven or furnace model, the Load Thermocouple may be in a fixed position, or may be movable. The Element Thermocouple is fixed in a predetermined position near the heating elements. The Load Thermocouple should be placed as near as possible to the work to be heated.

The Load Loop communicates with the Element Loop, calling for heat according to the load temperature and the current program or set point. The Element Loop regulates the heat according to element temperature and the requests from the Load Loop.

The element temperature could, in principle, vary between the furnace or oven maximum and minimum, regardless of the working temperature of the load. In practice, the cascade control system is configured to limit the element temperature to a band around the load temperature, typically of  $\pm 10\%$  of the set-point temperature.

The set point of the load loop, shown at the top of the display, can be adjusted by the operator. The Element Loop, shown at the bottom of the display, should not be adjusted by the operator & will automatically regulate the element temperature to achieve the Load set temperature.

In a three-zone furnace for which the "three zone cascade" option has been ordered the centre zone is a 3508 Dual Loop & separate end zone controls are fitted. The operator sets the Load loop set point on the 3508 centre zone. The end zone controllers work automatically & need no adjustment by the operator.

### 4.2 Operation of Cascade Control

The operator may ignore all the complications of the system, and program the Load Loop according to the standard instructions for that controller. The home display shows the load loop at the top of the display and the Element loop at the bottom. By pressing the page key, separate views of load and element loops will be shown.



Key	
A	Home Display View
B	Load Loop View
C	Element Loop View

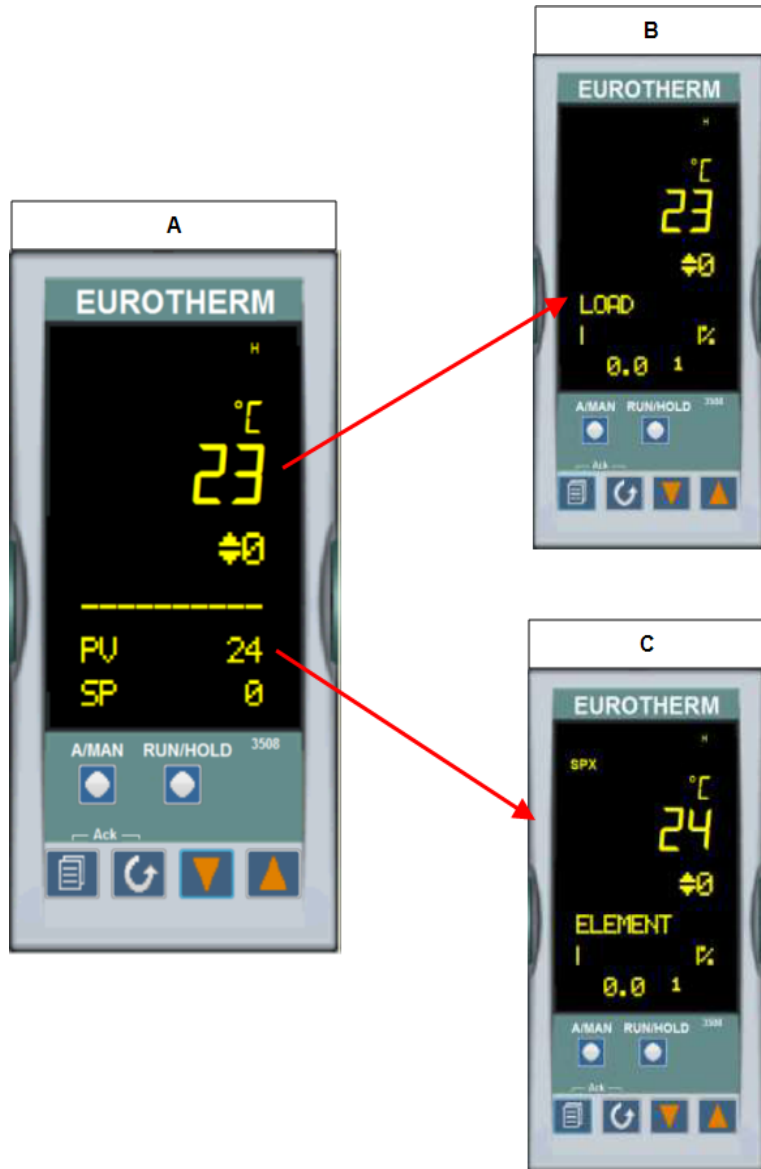

The Element Loop should never be adjusted. Note that the elements usually run at a higher temperature than the load.

Because the details of the customer's cascade application (in particular the nature of the load) are generally not known, the feed forward parameter (FF Trim) is made easily accessible in level 2 (Refer to instrument operating instructions). Its default setting is 2%. If overshoot of the load temperature occurs – often a problem at low temperatures – then FF Trim can be reduced in order to limit the amount of overshoot. However, if FF trim is reduced too much, the load may not reach the desired temperature. If the load does not reach the desired temperature or is slow in the final stages, FF Trim can be increased: a maximum of 10% is suggested.



*Feed Forward View*

When attempting to control at very low temperatures it can become a problem to achieve stable control because of excessive power being supplied during heating. The available power can be limited using the power limit parameter OP.Hi, make a note of the original settings before adjusting. For power settings please refer to the fuse and power section at the back of the manual. If the parameter is normally set to 100%, try initially setting it to 50% to improve stability. Avoid settings below 40% where possible (though some furnaces require low settings for reasons unconnected with cascade control).



*Power Limit View*

### 4.3 Bypassing Cascade Control

This applies where the Control Thermocouple is a removal probe (e.g. in a tube furnace), or where for other reasons it may be required to operate the furnace or oven directly from the Element Loop.

To operate without Cascade Control the load thermocouple has to remain connected at all time; or a link has to be made across the thermocouple input connections.

### 4.4 3508P1 Element Loop (Loop 2)

In these circumstances the Element Controller is configured with the local/remote parameter, accessible in level 2 (Refer to instrument operating instructions).

To switch cascade control on or off. In Level 2, press Scroll until the display shows *L-r*.

Using the up ▲ down ▼ set:

- *SP2* = cascade control on
- *SP1* = cascade control off

The top left hand side of the screen will show *SPX* when *SP2* is enabled. The instrument operates as an independent Programmer/Controller when *L-r* is set to *SP1*. To return to cascade control, change the *L-r* parameter to *SP2*. Also note that cooling at low temperatures takes longer per degree than it does at high temperatures.

### 4.5 Caution



If the Load Thermocouple is removable, leave it in the furnace or oven chamber whenever possible. Operating with the Cascade Control active and with the Load Thermocouple in an unheated position (such as lying on the work bench) may cause the furnace or oven to heat up to its maximum temperature, wasting power and possibly shortening element life.

### 4.6 Over-Temperature Control

Where over-temperature control is fitted, it normally protects against failure of the control system or of a component such as a power control relay. The over-temperature controller must be set at a level higher than the greatest element temperature, typically 15 °C above maximum.

If the working temperature is less than the maximum temperature, then it may be possible to set the over-temperature limit as follows:

$$\text{working temperature} + (\text{maximum temperature} \times \text{FF}/100) + 15 \text{ } ^\circ\text{C}$$

where FF is the Feed Forward percent parameter value (e.g. 10)

Example: for working at 800 °C in a 1200 °C product, the over-temperature limit could be set to  $800+120+15=935$ .

## 5.0 2132 Over-Temperature Controller Description (if fitted)

### 5.1 Description



This over-temperature controller is fitted and supplied ready to use by Carbolite Gero. It is a digital instrument with a latching alarm, requiring no additional panel controls. The controller features easy setting of over-temperature setpoint and reading of current temperature by the over-temperature sensor.

### 5.2 Operation

#### 5.2.1 Controls

Most Carbolite Gero products are fitted with an instrument switch which cuts off power to the controller and other parts of the control circuit.

To operate the controller, power must be supplied to the product and the instrument switch must be on. If a time switch is included in the product circuit, this must be in the 'ON' position.

When an over-temperature condition occurs, the controller cuts the power to a contactor, which in turn cuts power to the heating elements. Power is not restored until the controller is 'reset'.

Some components will operate after the over-temperature feature isolates the power supply e.g. cooling fans will continue to operate, provided that there is a power supply to the product. In some cases the product may not do so, if other options (such as a door switch) are fitted.

### 5.2.2 Operation

When switched on, the controller lights up, goes through a short test routine and then displays the measured temperature or the over-temperature setpoint.

The page key  allows access to parameter lists within the controller.

A single press of the page key  displays the temperature units, normally set to °C; further presses reveal the lists indicated in the navigation diagram.



The scroll key  allows access to the parameters within a list. Some parameters are display-only; others may be altered by the operator.

A single press of the scroll key  in the 'Home' list displays the temperature units; further presses reveal the parameters in the current list indicated in the navigation diagram.

To return to the 'Home' list at any time, press page  and scroll  together, or wait for 45 seconds.

The down  and up  keys are used to alter the setpoint or other parameter values.

### 5.2.3 Over-Temperature Operation

Use down  and up  to alter the over-temperature setpoint. This should normally be set a little above the working temperature (for example 15 °C above). The product is supplied with the over-temperature set at 15 °C above the furnace or oven maximum working temperature.

Press scroll  twice view the present temperature as measured by the over-temperature controller. Press it twice, the first press shows the temperature units (°C).

### 5.2.4 Over-Temperature Alarm

If an over-temperature condition occurs, the OP2 indicator flashes and an alarm message 2FSH also flashes, alternating with the setpoint. Power to the heating elements is disconnected.

### 5.2.5 Resetting the Over-Temperature Alarm

To acknowledge the alarm press scroll  and page  together.

If the alarm is acknowledged while there is still an over-temperature condition, the OP2 indicator stops flashing but continues to glow. The 2FSH alarm continues to flash until the over-temperature condition is cleared (by the temperature falling), when normal operation resumes.

If the alarm is acknowledged when the temperature has dropped (or after the over-temperature setpoint has been raised) so that the over-temperature condition no longer exists, then the furnace or oven immediately resumes normal operation.

### 5.2.6 Sensor Break

The over-temperature cut-out system also operates if the over-temperature control thermocouple breaks or becomes disconnected. The message S.br flashes where the measured temperature is normally displayed.

### 5.3 Audible Alarm

If an audible alarm is supplied for use with the over-temperature controller, it is normally configured to sound on over-temperature condition and to stop sounding when the alarm is acknowledged as given in section 5.2.

Note: the alarm may sound during controller start-up.

### 5.4 Navigation Diagram

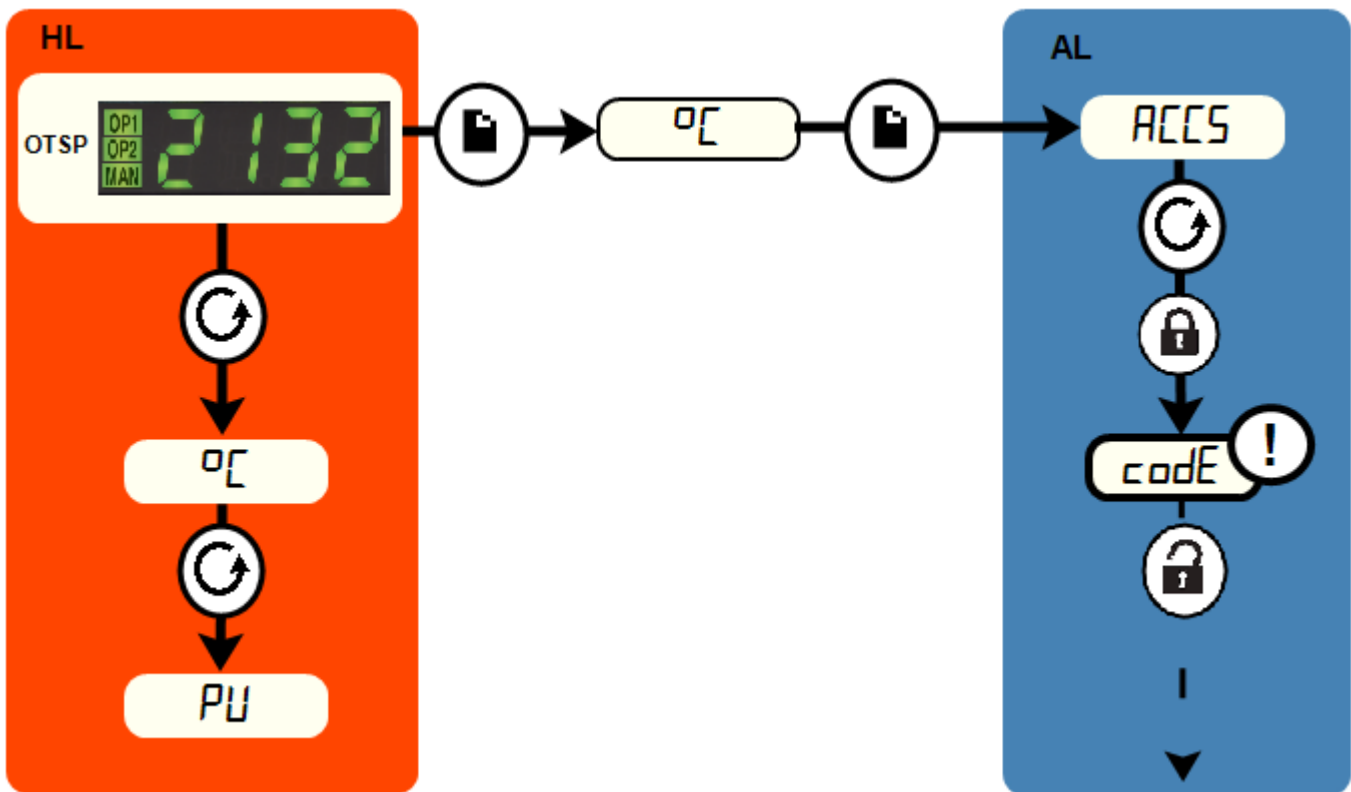

<b>HL</b>	Home List		Page Key	➔	Black = Progress
<b>OTSP</b>	Over-Temperature Setpoint		Scroll Key		Dashed = Through to other options
<b>AL</b>	Access List		For factory access to list and parameters not available to the operator.		

## 6.0 Operation

### 6.1 Operating Cycle

This product is fitted with an instrument switch which cuts off power to the control circuit.

Connect the product to the electrical supply.

Turn on the instrument switch to activate the temperature controllers. The controllers illuminate and go through a short test cycle.

**Over-Temperature option only.** If the digital over-temperature option has not yet been set as required, set and activate it according to the over-temperature controller instructions.

The product will heat up according to the controller setpoint or program, unless a time switch is fitted and switched off.

As the product heats up, the heat light glows steadily at first and then flashes as the product approaches the desired temperature. For more information on temperature control see the controller instructions.

**Over-Temperature option only.** If the over-temperature circuit has tripped, an indicator on the over-temperature controller flashes and the heating elements are isolated. Find and correct the cause before resetting the over-temperature controller according to the instructions supplied.

To turn the product off, set the instrument switch to its off position. The controller display will go blank. If the product is to be left unattended, isolate it from the electrical supply.

### 6.2 General Operating Notes



Heating element life is shortened by overheating. Do not leave the product at high temperature when it is not required. The maximum temperature is shown on the product rating label and in section 12.0 towards the back of this manual.

When heating large objects, in particular poor conductors, avoid shielding the thermocouple from the heating elements. The thermocouple is intended to sense the temperature near the heating elements. However, if a large object is placed in the chamber it may record the average temperature of the object and the elements, this can lead to overheating of the elements. Allow large objects to gain heat at a lower temperature and then reset the controller to a temperature close to the desired maximum, or heat using a slowly controlled ramp rate. For more information refer to the controller instructions.

When heating materials that produce smoke or fumes, the chimney must be correctly fitted and unobstructed. If not, soot will accumulate in the chamber and could possibly cause an electrical breakdown of the heating element. If the furnace is used to heat



materials that emit smoke or fumes, regularly heat it up to maximum temperature for one hour with the chamber empty to burn away the soot.

Materials such as case hardening compounds and other reactive salts may penetrate the furnace chamber lining and attack the wire elements, causing premature failure. Use of a hearth tile may be advisable: please consult the Carbolite Gero technical department.

### 6.3 Use of Probes



Any metal object used to probe into the product chamber while the product is connected to the electrical supply must be earthed. This applies in particular to metal sheathed thermocouples, where the sheaths must be earthed. The refractory material of the chamber lining becomes partly conductive at high temperatures and the electric potential inside the chamber can be at any value between zero and the supply voltage. Unearthed probes can cause serious electric shock.

### 6.4 Atmospheres

When an optional gas inlet is fitted, there is a label near the inlet saying "INERT GAS ONLY". In practice, inert or oxidising gases may be used, but not combustible or toxic gases.

The chamber is not gas tight, the gas usage may be high and the chamber is always likely to contain some air. Residual oxygen of approximately 1% to 2% is to be expected.

### 6.5 Operator Safety



This product incorporates a safety switch which interrupts the heating element circuit when the furnace is opened. This prevents the operator touching a live heating element and also prevents the product from heating up if the furnace is left open. The operation of this switch should be checked periodically.



Depending on use, the surfaces in the working chamber and the chamber load may still be very hot after the appliance is switched off. Touching these surfaces may cause burns. Use suitable personal protective equipment or wait until the appliance cools down to ambient temperature.

Before removing a hot object from the product, make sure there is a safe place to put it down. If necessary use tongs, face masks and heat resistant gloves. Heat resistant clothing and face protection can guard against the effects of radiated heat when the furnace is open.

When the product is opened during operation there is considerable radiated heat. Do not keep any flammable objects near the product, nor objects which could be damaged by radiated heat.

## 6.6 Power Adjustment

The product control system incorporates electronic power limiting. Depending on the model and the destination country the power limit maybe set to 100% or a lower figure. Where appropriate the power limit parameter OP.Hi is accessible to the operator, but it should not generally be altered.

See section 11.0 for details of the power limit settings. DO NOT adjust the power to a level higher than the design level states; this may cause a fuse to blow and could damage the heating elements.

The power limit may be set to a lower limit if the product is to be used at a low temperature only: this may give better control stability. It may be set to zero to permit demonstration of the controls without the heating elements taking power; to resume heating reset it to its standard value.

## 7.0 Maintenance

### 7.1 General Maintenance

Preventive rather than reactive maintenance is recommended. The type and frequency depends on the product use; the following are recommended.



### 7.2 Maintenance Schedule

 CUSTOMER

 QUALIFIED PERSONNEL



**DANGER! ELECTRIC SHOCK.** Risk of fatal injury. Only electrically qualified personnel should attempt these maintenance procedures.

Maintenance Procedure	Method	Frequency				
		Daily	Weekly	Monthly	Bi-Annually	Annually
<b>Safety</b>						
Safety Switch Function	Set a safe temperature above ambient, and open the door to see if the heater light goes out					
Safety Switch Function	Electrical measurement 					
Over-Temperature Safety Circuit (if fitted)	Set an over-temperature setpoint lower than the displayed temperature and check for an over-temperature alarm as detailed in this manual					
Over-Temperature Safety Circuit (if fitted)	Electrical measurement 					
Door Plug	Visual inspection, checking the seal and whether it is free of damage					
Door Plug	Replacement where necessary					
Chimney / Extraction	Check and clean if necessary					
Electrical Safety (external)	Visual check of external cables and plugs					
Electrical Safety (internal)	Physically check all connections and cleaning of the power plate area					
<b>Function</b>						
Temperature Calibration	Tested using certified equipment, frequency dependent on the standard required					
Operational Check	Check that all functions are working normally					

## 7.0 Maintenance

Operational Check	Thorough inspection and report incorporating a test of all functions						6
<b>Performance</b>							
Element Circuit	Electrical measurement 						6
Power Consumption	Measure the current drawn on each phase / circuit						6
Hearth	Visual check for fit and damage						
Cooling Fans (if fitted)	Check whether the cooling fans are working						

### 7.2.1 Cleaning

Soot deposits may form inside the furnace, depending on the process. At appropriate intervals remove these by heating as indicated in the General Operation Notes.



The product's outer surface may be cleaned with a damp cloth. Do not allow water to enter the interior of the case or chamber. Do not clean with organic solvents.

### 7.2.2 Safety Switch

When correctly functioning, the safety switch will isolate all live conductors (live and neutral connections) within the heating element circuit(s) when the product door is opened. The safety switch should be checked regularly to ensure that this occurs.

The safety switch should not fail under normal working conditions, however rough handling, exposure to corrosive materials/ environments, or exceptionally frequent use, could compromise the safety system.

#### **Weekly check:**

The following check can be carried out by a general operator:

- On the temperature controller, set a safe temperature above ambient. The heater lights should illuminate.
- Open the door and check the heater lights. They should no longer be illuminated.

If the heater lights remain illuminated when the door is open, discontinue use and contact Carbolite Gero Service.

#### **Annual check:**

The following checks should be carried out by a qualified electrician, as specified in the "Maintenance Schedule" section of this manual:

- Remove the element access panel and take a voltage measurement from the heating element terminals. Do not attempt to take a reading from the heating element itself as surface oxidation will give an unreliable contact.
- Ensure that power to the heating elements is switched off when the door is opened.

Contact Carbolite Gero Service and discontinue use of the product if it is found that the heating elements are not fully isolated during these checks.

## **7.3 Calibration**

After prolonged use, the controller and/or thermocouple may require recalibration. This is important for processes that require accurate temperature readings or for those that use the product close to its maximum temperature. A quick check using an independent

thermocouple and temperature indicator should be made from time to time to determine whether full calibration is required. Carbolite Gero can supply these items. Depending on the controller fitted, the controller instructions may contain calibration instructions.

#### **7.4 After-Sales Service**

Carbolite Gero Service has a team of Service Engineers who can offer repair, calibration and preventive maintenance of furnace and oven products both at the Carbolite Gero factory and at customers' premises throughout the world. A telephone call or email often enables a fault to be diagnosed and the necessary parts to be despatched.

In all correspondence please quote the serial number and model type given on the rating label of the product. The serial number and model type are also given on the back of this manual when supplied with the product.

Carbolite Gero Service and Carbolite Gero contact information can be found on the back page of this manual.

#### **7.5 Recommended Spare Parts and Spare Parts Kit**

Carbolite Gero can supply individual spare parts or a kit of the items most likely to be required. Ordering a kit in advance can save time in the event of a breakdown.

Each kit consists of one thermocouple, one sheath, one solid state relay, one door insulation piece and a set of elements.

When ordering spare parts please quote the model details and serial number as requested above.

## 8.0 Repairs and Replacements

### 8.1 Safety Warning - Disconnection from Power Supply



Immediately switch the product off in the event of unforeseen circumstances (e.g. large amount of smoke). Allow the product to return to room temperature before inspection.



Always ensure that the product is disconnected from the electrical supply before repair work is carried out.

**Caution:** Double pole/neutral fusing may be used in this product.

### 8.2 Safety Warning - Refractory Fibre Insulation



**Insulation made from High Temperature Insulation Wool Refractory Ceramic Fibre, better known as (Alumina silicate wool - ASW).**

This product contains **alumino silicate wool** products in its thermal insulation. These materials may be in the form of blanket or felt, formed board or shapes, slab or loose fill wool.

Typical use does not result in any significant level of airborne dust from these materials, but much higher levels may be encountered during maintenance or repair.

Whilst there is no evidence of any long term health hazards, it is strongly recommended that safety precautions are taken whenever the materials are handled.

**Exposure to fibre dust may cause respiratory disease.**

**When handling the material, always use approved respiratory protection equipment (RPE-eg. FFP3), eye protection, gloves and long sleeved clothing.**

**Avoid breaking up waste material. Dispose of waste in sealed containers.**

**After handling, rinse exposed skin with water before washing gently with soap (not detergent). Wash work clothing separately.**

Before commencing any major repairs it is recommended to make reference to the European Association representing the High Temperature Insulation Wool industry ([www.ecfia.eu](http://www.ecfia.eu)).

Further information can be provided on request. Alternatively, Carbolite Gero Service can quote for any repairs to be carried out either on site or at the Carbolite Gero factory.

### 8.3 Temperature Controller Replacement

Refer to the controller instructions for more information on how to replace the temperature controller.

## 8.4 Solid-State Relay Replacement



Disconnect the product from the power supply and remove the appropriate cover as given above.

1. Make a note of the wire connections to the solid state relay, then disconnect them.
2. Remove the solid state relay from the base panel or aluminium plate.
3. Replace and reconnect the solid state relay ensuring that the bottom of it has good thermal contact with the base panel or aluminium plate.
4. Replace the access panel.

## 8.5 Thermocouple Replacement



Disconnect the product from the power supply. Remove terminal cover to gain access to the thermocouple connections. Make a note of the thermocouple connections.

Thermocouple cable colour codings are:

Thermocouple leg	Colour
positive (type K)	green
negative	white

Disconnect the thermocouple from its terminal block and withdraw the thermocouple from its sheath by bending the metal tag or releasing the screw to release. It is also advisable to remove the sheath and shake out any broken pieces of thermocouple.

Re-assemble with a new thermocouple, observing the colour coding, ensuring that the thermocouple is not twisted as it is being inserted and that the metal tag is bent back to grip the sheath.

Refit the element access panel.



## 8.6 Element Replacement



**See section 8.2 - wearing a face mask is required.**

The chamber of this type of furnace is formed by winding resistance heating wire on to a refractory muffle former. In the event of failure, the whole "wound muffle" assembly must be replaced.

Disconnect the furnace from the electrical supply and remove the furnace back panel. Pull the chimney out of the top of the furnace.

Make a note of the wiring connections; "Thermocouple Replacement" above which refers to the thermocouple colour coding.

Unfasten the electrical connections to the inner chamber (brick-box) and remove the thermocouple and sheath (see thermocouple replacement instructions). If the connections are secured by hexagonal nuts, two spanners should be used to avoid cracking the porcelain mounting.

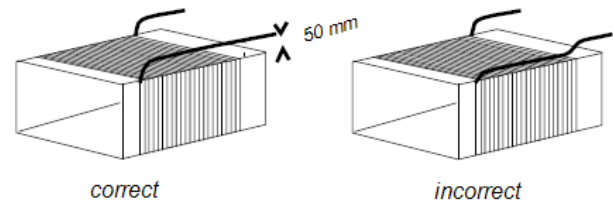

Undo any self-tapping screws and hook bolts necessary to release the brick-box.

Support the front of the brick-box as you withdraw it from the case so it does not fall onto the electrical connections below.

Remove the brick-box lid and top insulating board, noting how it is assembled and observing the position of the heating element wires (or "tails").

Pull the element tails out of the terminal block and remove sufficient insulation to allow access to the heating element. Check and replace damaged insulation.

Fit the new heating element, ensuring that the tails are separated from the element by at least 25 mm (preferably 50 mm) of insulation – see the image above.

Feed the element tails through the terminal blocks and tighten the clamping screws using two spanners as before. Cut off excess element tails.

Complete the fitting of the insulation and refit the lid. Do not use any cement unless supplied by Carbolite Gero, as other types may chemically attack the heating element.

Replace and fasten the brick-box into the furnace case.

Replace the thermocouple and sheath and remake the electrical connections. In porcelain and brass terminal blocks the brass connector should be slightly loose in its porcelain support block to allow for expansion.

Replace the back panel and reconnect the electrical supply.

Switch the furnace ON and heat to 900 °C without interruption and then dwell for 1 hour. Some smoke may be observed during this process, which should be carried out in a well ventilated area.

Check that the furnace is controlling properly to rule out the possibility that previous element failed because of a fault in the control circuit.

## 8.7 Door Plug Replacement



See section 8.2 - wearing a face mask is required.

Open the door and remove the door cover from the plug carrier assembly.

Remove the old door plug by sliding it upwards out of its carrier.

Slide the new plug into the carrier assembly making sure that the plug is the correct way up.

Refit the door cover.

When first heating the furnace after a replacement, ensure that the ventilation is good: emission of some fumes is to be expected.

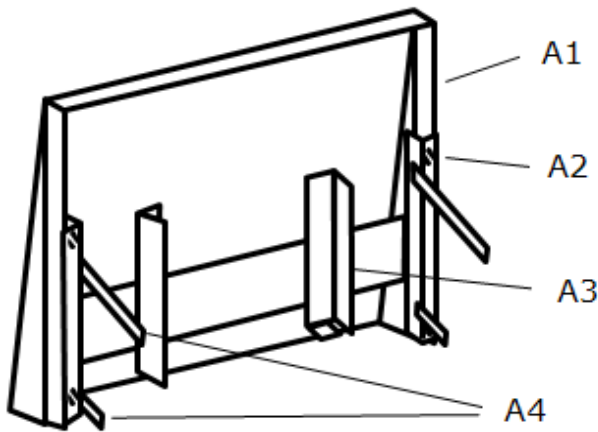

**A**

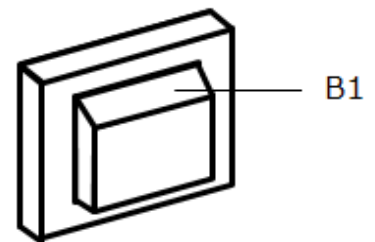

**B**

Key	
A	Door (seen from the back)
A1	Door Cover
A2	Fixing Screws
A3	Door Plug Carrier
A4	Door Link Arms
B	Door Plug
B1	Top

## 8.8 Fuse Replacement

Fuses are marked on the wiring diagram with type codes, e.g. F1, F2. For more information on fuses refer to section 11.0.

*Depending on model and voltage, the different fuse types may or may not be fitted.*

If any fuse has failed, it is advisable for an electrician to check the internal circuits.

Replace any failed fuses with the correct type. For safety reasons do not fit larger capacity fuses without first consulting Carbolite Gero.

The fuses are located at the cable entry point. Remove the back panel or control box back panel to gain access to the fuses.

## 9.0 Fault Analysis

A. Furnace Does Not Heat Up				
1.	The HEAT light is ON	▶	The heating element has failed	▶ Check also that the SSR is working correctly
2.	The HEAT light is OFF	▶	The controller shows a very high temperature or code such as S.br	▶ The thermocouple has broken or has a wiring fault
		▶	The controller shows a low temperature	▶ The door switch(es) (if fitted) may be faulty or need adjustment
				▶ The contactor/relay (if fitted) may be faulty
				▶ The heater switch (if fitted) may be faulty or need adjustment
				▶ The SSR could be failing to switch on due to internal failure, faulty logic wiring from the controller, or faulty controller
		▶	There are no lights glowing on the controller	▶ Check the supply fuses and any fuses in the furnace control compartment
				▶ The controller may be faulty or not receiving a supply due to a faulty switch or a wiring fault.

**B. Product Overheats**

1.	Product only heats up when the instrument switch is ON	▶	The controller shows a very high temperature	▶	The controller is faulty
		▶	The controller shows a low temperature	▶	The thermocouple may be faulty or may have been removed out of the heating chamber
				▶	The thermocouple may be connected the wrong way around
				▶	The controller may be faulty
2.	Product heats up when the instrument switch is OFF	▶	The SSR has failed "ON"	▶	Check for an accidental wiring fault that could have overloaded the SSR

# 10.0 Wiring Diagrams

## 10.1 WA-11-30

Connections below show single phase with indirect safety switch(es).

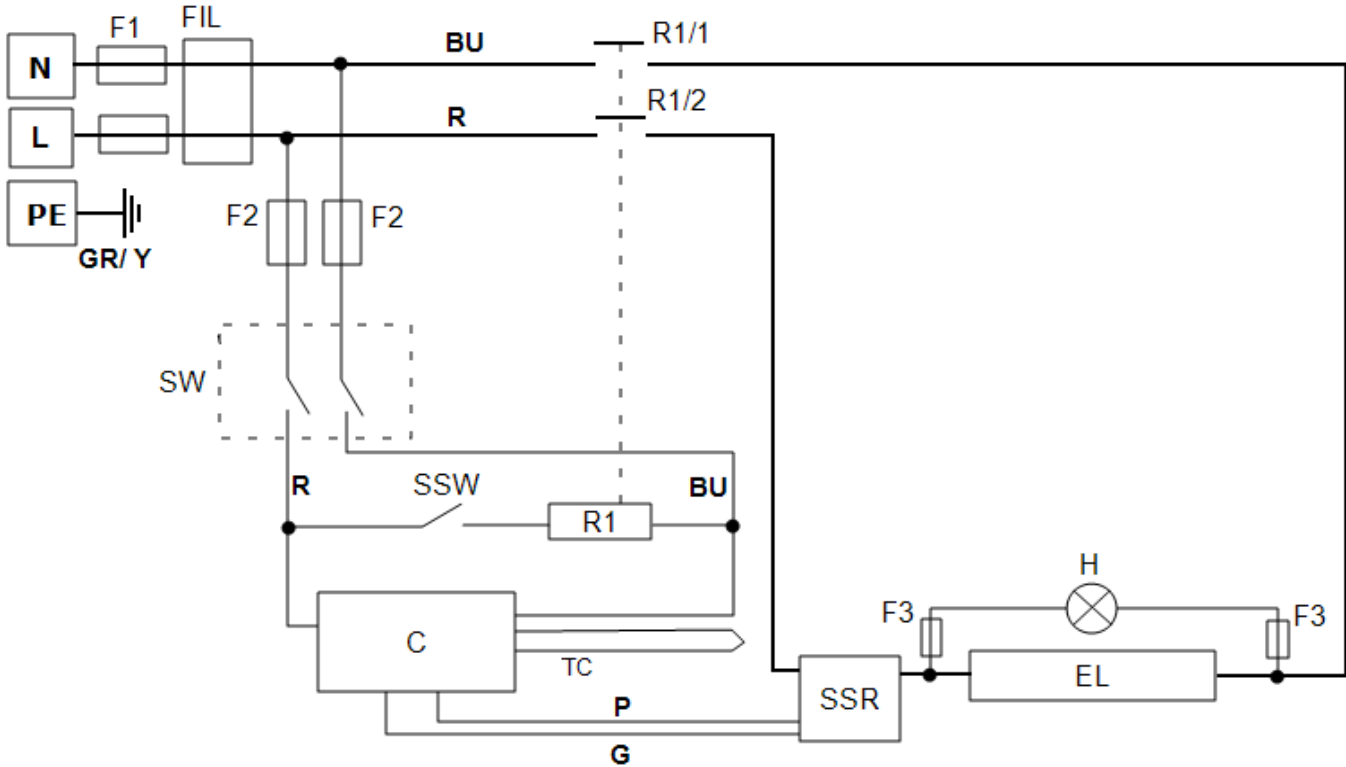

Key	
F1, F2, F3	Fuses
FIL	Filter
R1/1, R1/2	Relay Contactor
R1	Relay
C	Temperature Controller
TC	Control Thermocouple
SSR	Solid State Relay
SSW	Safety Switch
H	Heat Lamp
EL	Element(s)
SW	Instrument Switch(es)
N	Neutral
L	Live
PE	Earth

Cables	
BU	Blue
R	Red
GR/Y	Green + Yellow
G	Grey
P	Pink

**10.2 WA-11-31**

Connections below show single phase with safety switches and over-temperature control.

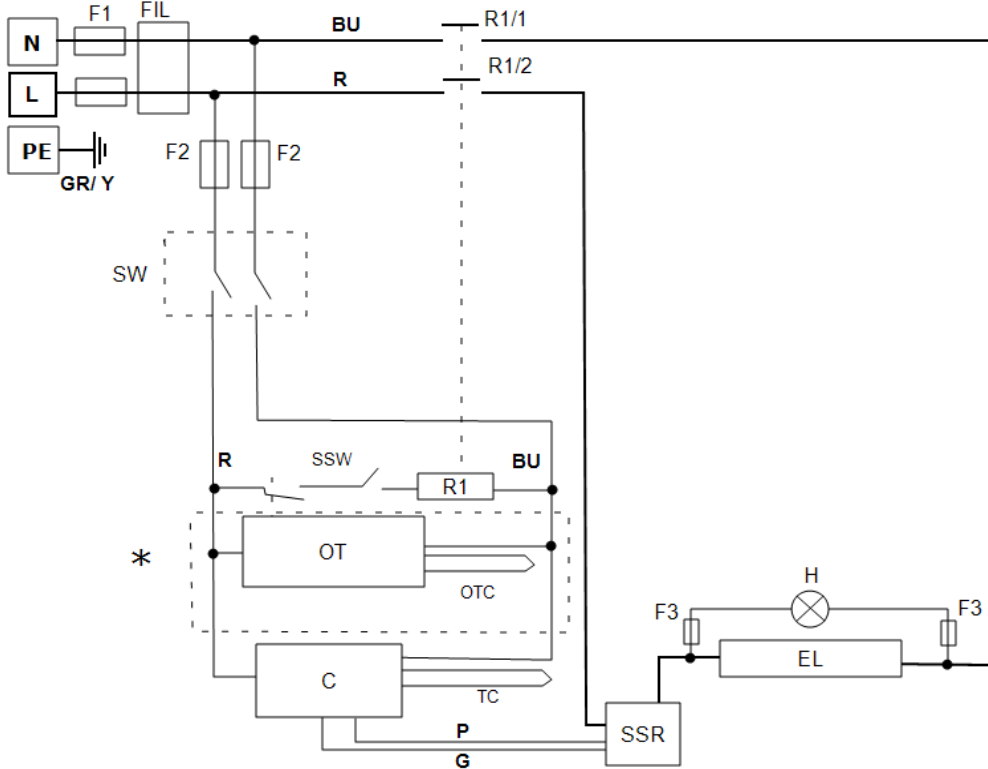

Key	
F1, F2, F3	Fuses
FIL	Filter
R1/1, R1/2	Relay Contactor
R1	Relay
C	Temperature Controller
OT	Over-Temperature Controller
OTC	Over-Temperature Thermocouple
TC	Control Thermocouple
SSR	Solid State Relay
SSW	Safety Switch
H	Heat Lamp
EL	Element(s)
SW	Instrument Switch(es)
N	Neutral
L	Live
PE	Earth
*	If Fitted

Cables	
BU	Blue
R	Red
GR/Y	Green + Yellow
G	Grey
P	Pink



**10.3 WA-22-30**

Connections below show 2-phase +N with indirect safety switches.

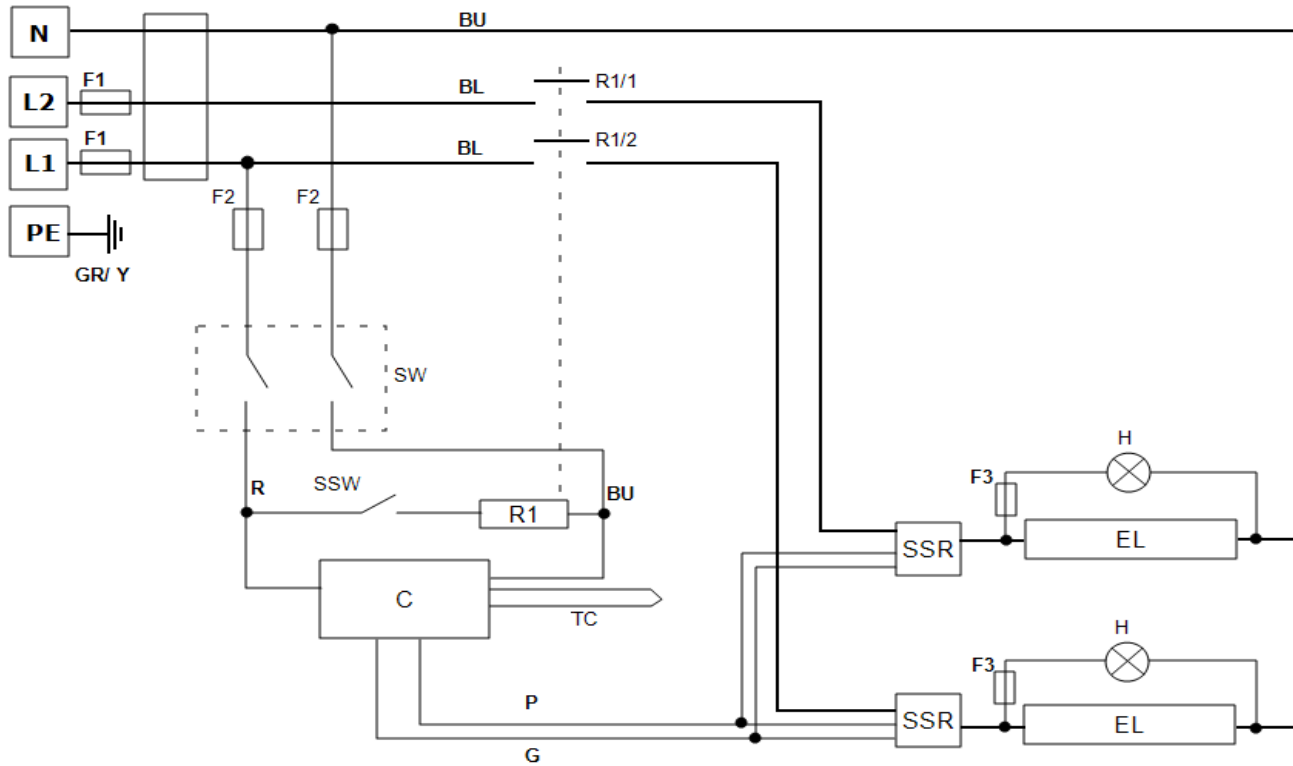

Key	
F1, F2, F3	Fuses
FIL	Filter
R1/1, R1/2	Relay Contactor
R1	Relay
C	Temperature Controller
TC	Control Thermocouple
SSR	Solid State Relay
SSW	Safety Switch
H	Heat Lamp
EL	Element(s)
SW	Instrument Switch(es)
N	Neutral
L1/L2	Live
PE	Earth

Cables	
BU	Blue
R	Red
GR/Y	Green + Yellow
G	Grey
P	Pink

## 11.0 Fuses and Power Settings

### 11.1 Fuses

F1-F3: Refer to the circuit diagrams.

F1	Internal Supply Fuses	Fitted if supply cable fitted. Fitted on board to some types of EMC filter.	GEC Safeclip of the type shown (glass type F up to 16 A) 38 mm x 10 mm type F fitted on EMC filter circuit board(s)
F2	Auxiliary Circuit Fuses	Fitted on board to some types of EMC filter. May be omitted up to 25 Amp/phase supply rating.	2 Amps glass type F On board: 20 mm x 5 mm Other: 32 mm x 6 mm
F3	Heat Light Fuses	May be omitted up to 25 Amp/phase supply rating.	2 Amps glass type F 32 mm x 6 mm
	Customer Fuses	Required if no supply cable fitted. Recommended if cable fitted.	See rating label for current; See table below for fuse rating.

Model	Phases	Volts	Supply Fuse Rating
AAF 11/7	1-phase	110	32 A
AAF 11/7	1-phase	120	40 A
AAF 11/7	1-phase	200-208	20 A
AAF 11/7	1-phase	220-230	16 A
AAF 11/7	1-phase	240	20 A
AAF 11/7	2-phase +N	380-415	10 A per phase

### 11.2 Power Settings

The power limit settings (parameter OP.Hi) for this model are voltage dependant. The figures represent the maximum percentage of time that controlled power is supplied to the elements. Do not attempt to "improve performance" by setting a value higher than the recommended values. To adjust the parameter refer to the "Changing the Maximum Output Power" of the control section of the manual.

Volts	110 V	200 V	208 V	220 V 380 V	230 V 400 V	240 V 415 V	254 V 440 V
Power (%)	100	100	100	100	100	100	89

Please refer to the rating label for product specific information.

## 12.0 Specifications

*Carbolite Gero reserves the right to change the specification without notice.*

Model	Max Temp (°C)	Max Power (kW)	External Size (mm)			Chamber Size (mm)			Net Weight (kg)
			H	W	D	H	W	D	
Ashing Burn-off and Coal and Coke Testing Furnace									
AAF 11/7	1100	4	650	430	740	90	170	445	63

### 12.1 Environment

The models listed in this manual contains electrical parts and should be stored and used in indoor conditions as follows:

Temperature: 5 °C - 40 °C

Relative humidity: Maximum 80 % up to 31 °C decreasing linearly to 50 % at 40 °C



Service Record

Engineer Name	Date	Record of Work

ProductLabel

The products covered in this manual are only a small part of the wide range of ovens, chamber furnaces and tube furnaces manufactured by Carbolite Gero for laboratory and industrial use. For further details of our standard or custom built products please contact us at the address below, or ask your nearest stockist.

For preventive maintenance, repair and calibration of all furnace and oven products, please contact:

**Carbolite Gero Service**

Telephone: + 44 (0) 1433 624242

Fax: +44 (0) 1433 624243

Email: [ServiceUK@carbolite-gero.com](mailto:ServiceUK@carbolite-gero.com)

**Carbolite Gero Ltd,**

Parsons Lane, Hope, Hope Valley,  
S33 6RB, England.

Telephone: + 44 (0) 1433 620011

Fax: + 44 (0) 1433 621198

Email: [Info@carbolite-gero.com](mailto:Info@carbolite-gero.com)

[www.carbolite-gero.com](http://www.carbolite-gero.com)

**CARBOLITE**  
**GERO 30-3000°C**

Copyright © 2019 Carbolite Gero Limited