

Installation, Operation and Maintenance Instructions 1800°C Bottom Loading Furnace - BLF Model: 3 Litres No Controller

BLF 18/3 + No Controller

Contents

This manual is for guidance on the use of the Carbolite Gero product specified on the front cover. This manual should be read thoroughly before unpacking and using the furnace or oven. The model details and serial number are shown on the back of this manual. Use the product for the purpose for which it is intended.

1.0	Symbols and Warnings	4
1.1	Switches and Lights	4
1.2	General Warnings	4
2.0	Installation	5
2.1	Unpacking and Handling	5
2.2	Siting and Setting Up	5
2.3	Tie Wrap Removal Instructions	7
2.4	Fitting the Chimney and Heating Elements	8
2.5	Electrical Connections	9
3.0	Temperature Controller	11
4.0	2132 Over-Temperature Controller Description (if fitted)	12
4.1	Description	12
4.2	Operation	12
4.2.1	Controls	12
4.2.2	Operation	13
4.2.3	Over-Temperature Operation	13
4.2.4	Over-Temperature Alarm	13
4.2.5	Resetting the Over-Temperature Alarm	13
4.2.6	Sensor Break	13
4.3	Audible Alarm	14
4.4	Navigation Diagram	14
5.0	Operation	15
5.1	Operating Cycle	15
5.2	Emergency Stop Button	15
5.3	General Operating Advice	15
5.4	Atmospheres & Corrosive Materials	16
5.5	Operator Safety	17
5.6	Notes on Temperature Control	17
5.7	Insulation Cracking	17
5.8	Thermocouple Warnings	17
5.9	Inverted Crucible Option	18
5.10	Element Protection Tube Option	18

6.0	Maintenance	19
6.1	General Maintenance	19
6.2	Maintenance Schedule	19
6.2.1	Cleaning	21
6.3	Calibration	21
6.4	After-Sales Service	21
6.5	Recommended Spare Parts and Spare Parts Kit	21
6.6	Power Adjustment (Controller)	21
6.7	Power Adjustment (Thyristor)	22
7.0	Repairs and Replacements	23
7.1	Safety Warning - Disconnection from Power Supply	23
7.2	Safety Warning - Refractory Fibre Insulation	23
7.3	Safety Warning - Molybdenum Disilicide Elements	24
7.4	Temperature Controller Replacement	24
7.5	Fuse Replacement	24
7.6	Thermocouple Replacement	24
7.7	Element Protection Tube Option Replacement Procedure	25
7.8	Insulation Replacement	25
7.9	Element Installation and Replacement	26
8.0	Fault Analysis	29
A.	Furnace Does Not Heat Up	29
B.	Product Overheats	30
9.0	Wiring Diagrams	31
9.1	195-1-1013	31
10.0	Fuses and Power Settings	32
10.1	Fuses	32
10.2	Power Settings	32
11.0	Specifications	34
11.1	Environment	34

1.0 Symbols and Warnings

1.1 Switches and Lights



Instrument switch: when the instrument switch is operated the temperature control circuit is energised.



Heat light: the adjacent light glows or flashes to indicate that power is being supplied to the elements.

1.2 General Warnings



DANGER – Electric shock. Read any warning printed next to this symbol.

WARNING: Risk of fatal injury.



DANGER – Hot surface. Read any warning printed next to this symbol.

WARNING: All surfaces of a product may be hot.



DANGER – Read any warning printed next to this symbol.

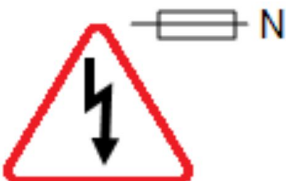

Caution – Double Pole/Neutral Fusing

2.0 Installation

2.1 Unpacking and Handling

When unpacking or moving the product always lift it by its base. Do not use the door or any other protruding parts. The product contains a transformer and is heavy: use two or more people to carry the product.

Some models may alternatively be lifted by fitting lifting bolts to captive threads in the top of the case.

Remove any packing material.



NOTE: This product contains Refractory Ceramic Fibre (also known as Alumino Silicate Wool - ASW). For precautions and advice on handling this material see section 7.2.

2.2 Siting and Setting Up

Place the product on a level surface in a well ventilated area.

Site away from other sources of heat and on a non-flammable surface that is resistant to accidental spillage or hot materials.

The surface on which the equipment is mounted should be stable and not subject to movement or vibrations.

The height of the mounting surface is important to avoid operator strain when loading and unloading samples.

Unless otherwise stated elsewhere in this manual, ensure that there is **at least 150 mm** of free space around the back and sides of the product. Clear space is required above the product to dissipate heat.

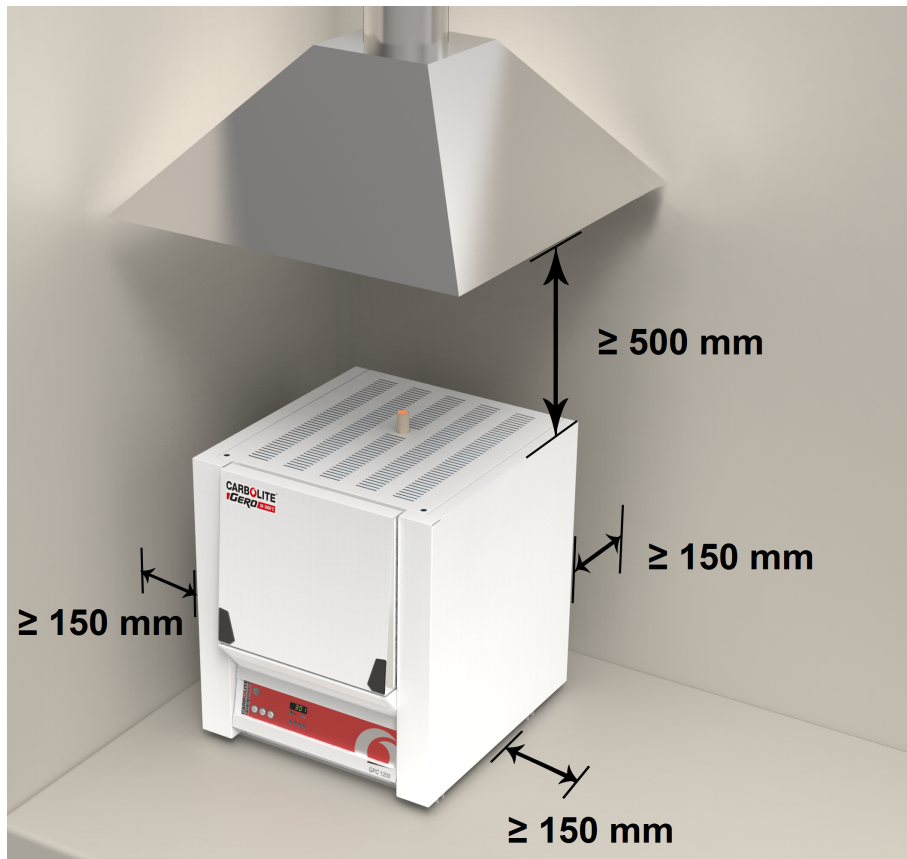

Depending on the application of the product, it may be appropriate to position it under an extraction hood. Ensure the extraction hood is switched on during use.

Ensure that the product is placed in such a way that it can be quickly switched off or disconnected from the electrical supply.



Under no circumstances should any objects be placed on top of the product. Always ensure that any vents on the top of the product are clear of any obstruction. Always ensure all cooling vents and cooling fans (if fitted) are clear of any obstruction.

2.3 Tie Wrap Removal Instructions

The motor powered arm that operates the hearth movement has been fixed in place for transit. Please ensure the plastic tie wrap used to fix the arm is removed before operation.

1. Remove the back panel of the furnace.
2. Locate the tie wrap that has been used to prevent the arm from moving. It is marked with a tag as shown in the photograph below.
3. Cut the tie wrap and discard.
4. Replace the back panel.



2.4 Fitting the Chimney and Heating Elements



Please refer to the Element Installation and Replacement in section 7.0. Wear eye protection when handling the heating elements.

The molybdenum disilicide elements are EXCEPTIONALLY FRAGILE and are packed separately, together with other items shown in the list.

separately packed items	BLF
Elements	6
Element Clamps	6
Elements Clips*	12
Braids*	1 set
Separators	6
* or combined clips and braids may be supplied	

BLF /3 transit clamps

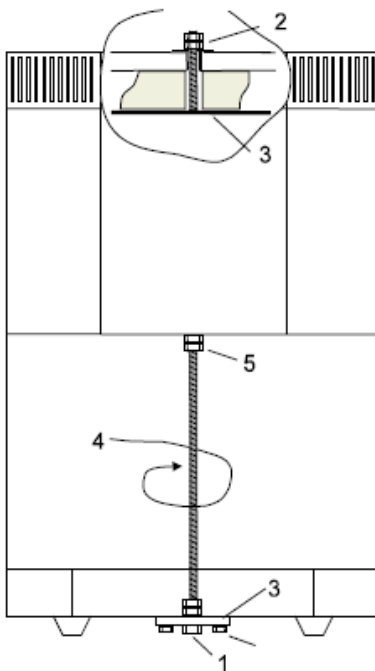

Upper Clamp:

1. Remove lower clamp first
2. Remove two M8 nuts and washers, supporting plate (3) from underneath
3. Remove plate

Lower Clamp:

1. Remove bottom M8 nut
2. Remove two M6 bolts
3. Remove plate
4. Unscrew rod, using spanner on (5) if necessary

Transit Clamps – dependent on model: the example shown here is for the 3 litre models; remove any transit clamps as shown. Fit the ceramic chimney to the hole that exits the top of the chamber. Most models are supplied with an insulation piece to fit around the chimney; fit this insulation.

Remove the complete top access panel using the hidden screw in holes in the top of the panel; loosen the screws two turns and remove the panel.

Fit the heating elements vertically into the chamber. Handle the elements with great care. The installation of these elements is described in section 7.9.

Connect the aluminium braids securely as indicated in the element installation instructions.

2.5 Electrical Connections



Connection by a qualified electrician is recommended.

This product requires a single-phase A.C. supply with earth (ground), which may be Live to Neutral non-reversible (polarised), Live to Neutral reversible (non-polarised), or Live to Live.

Check the product rating label before connection. The supply voltage should agree with the voltage on the label and the supply capacity should be sufficient for the current on the label.

The supply should be fused at the next size equal to, or higher than the current on the label. A table of the most common fuse ratings is also given towards the back of this manual. When the mains cable is factory fitted, internal fuses are also fitted. It is essential that the operator ensures that the product is correctly fused.

Products with a factory fitted supply cable are designed to be wired directly to an isolator or fitted with a line plug.

Products without a factory fitted supply cable require a permanent connection to a fused and isolated supply. The product's electrical access panel should be temporarily removed, and connections made to the internal terminals.

If the product is to be connected by line plug. The plug should be within reach of the operator and should be easy to remove.

When connecting the product to an isolating switch ensure that both conductors (single phase) or on all live conductors (three phase), and should be within reach of the operator.

The supply **MUST** incorporate an earth (ground).

Electrical Connection Details:

Supply	Terminal Label	Cable Colour	Supply Types	
			Live - Neutral	Reversible or Live-Live
1-phase	L	Brown	to live	to either power conductor (For USA 200-240V, connect L1)
	N	Blue	to neutral	to the other power conductor (For USA 200-240V, connect L2)
	PE	Green/ Yellow	to earth (ground)	to earth (ground)

3.0 Temperature Controller

If this product is fitted with a temperature controller, instructions are provided separately.

4.0 2132 Over-Temperature Controller Description (if fitted)

4.1 Description



This over-temperature controller is fitted and supplied ready to use by Carbolite Gero. It is a digital instrument with a latching alarm, requiring no additional panel controls. The controller features easy setting of over-temperature setpoint and reading of current temperature by the over-temperature sensor.

4.2 Operation

4.2.1 Controls

Most Carbolite Gero products are fitted with an instrument switch which cuts off power to the controller and other parts of the control circuit.

To operate the controller, power must be supplied to the product and the instrument switch must be on. If a time switch is included in the product circuit, this must be in the 'ON' position.

When an over-temperature condition occurs, the controller cuts the power to a contactor, which in turn cuts power to the heating elements. Power is not restored until the controller is 'reset'.

Some components will operate after the over-temperature feature isolates the power supply e.g. cooling fans will continue to operate, provided that there is a power supply to the product. In some cases the product may not do so, if other options (such as a door switch) are fitted.

4.2.2 Operation

When switched on, the controller lights up, goes through a short test routine and then displays the measured temperature or the over-temperature setpoint.

The page key  allows access to parameter lists within the controller.

A single press of the page key  displays the temperature units, normally set to °C; further presses reveal the lists indicated in the navigation diagram. See section 4.4.



The scroll key  allows access to the parameters within a list. Some parameters are display-only; others may be altered by the operator.

A single press of the scroll key  in the 'Home' list displays the temperature units; further presses reveal the parameters in the current list indicated in the navigation diagram.

To return to the 'Home' list at any time, press page  and scroll  together, or wait for 45 seconds.

The down  and up  keys are used to alter the setpoint or other parameter values.

4.2.3 Over-Temperature Operation

Use down  and up  to alter the over-temperature setpoint. This should normally be set a little above the working temperature (for example 15 °C above). The product is supplied with the over-temperature set at 15 °C above the furnace or oven maximum working temperature.

Press scroll  twice view the present temperature as measured by the over-temperature controller. Press it twice, the first press shows the temperature units (°C).

4.2.4 Over-Temperature Alarm

If an over-temperature condition occurs, the OP2 indicator flashes and an alarm message 2FSH also flashes, alternating with the setpoint. Power to the heating elements is disconnected.

4.2.5 Resetting the Over-Temperature Alarm

To acknowledge the alarm press scroll  and page  together.

If the alarm is acknowledged while there is still an over-temperature condition, the OP2 indicator stops flashing but continues to glow. The 2FSH alarm continues to flash until the over-temperature condition is cleared (by the temperature falling), when normal operation resumes.

If the alarm is acknowledged when the temperature has dropped (or after the over-temperature setpoint has been raised) so that the over-temperature condition no longer exists, then the furnace or oven immediately resumes normal operation.

4.2.6 Sensor Break

The over-temperature cut-out system also operates if the over-temperature control thermocouple breaks or becomes disconnected. The message S.br flashes where the measured temperature is normally displayed.

4.3 Audible Alarm

If an audible alarm is supplied for use with the over-temperature controller, it is normally configured to sound on over-temperature condition and to stop sounding when the alarm is acknowledged as given in section 4.2.

Note: the alarm may sound during controller start-up.

4.4 Navigation Diagram

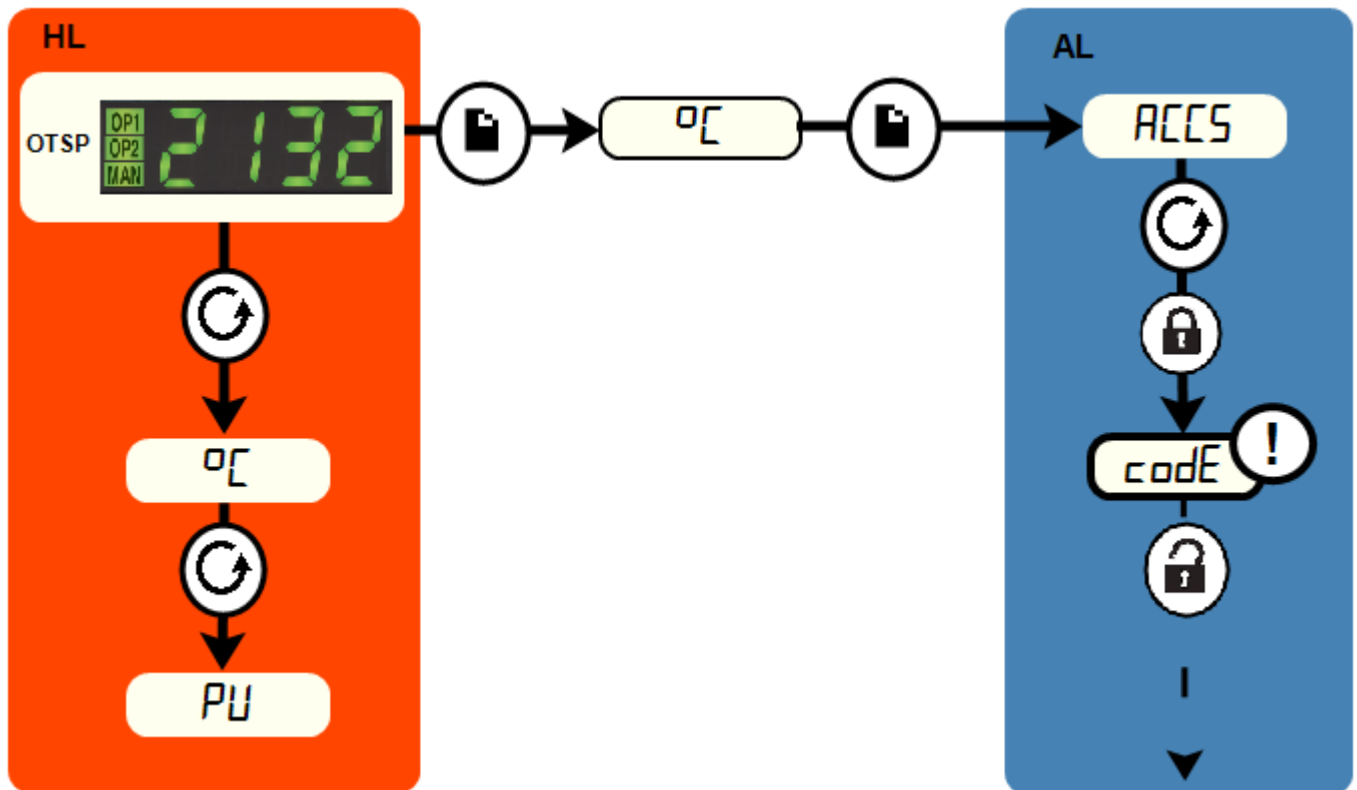

HL	Home List		Page Key	➔	Black = Progress
OTSP	Over-Temperature Setpoint		Scroll Key		Dashed = Through to other options
AL	Access List		For factory access to list and parameters not available to the operator.		

5.0 Operation

5.1 Operating Cycle

This product is fitted with an instrument switch which cuts off power to the control circuit.

Connect the product to the electrical supply.

The cooling fans should automatically operate.

The furnace is fitted with a pair of gates that have a safety switch. The hearth can only be lowered or raised if the gates are closed. The furnace is also fitted with a radiation shield. The hearth can only be raised or lowered if this is in the open position.

Check the hearth control switch for correct operation. The spring return switch stops the hearth in any position, but over-travel is automatically limited. Load the furnace and raise the hearth.

Turn on the instrument switch to activate the temperature controllers. The controllers illuminate and go through a short test cycle.

Set the over-temperature controller to a temperature a little (e.g. 15 °C) above the maximum setpoint of program temperature, according to the instructions supplied.

The product will heat up according to the controller setpoint or program, unless a time switch is fitted and switched off. The heat light glows brightly at first, more dimly as the product temperature approaches a program setpoint.

Over-Temperature option only. If the over-temperature circuit has tripped, an indicator on the over-temperature controller flashes and the heating elements are isolated. Find and correct the cause before resetting the over-temperature controller according to the instructions supplied.

To switch the furnace off, set the instrument switch to off. The case cooling fans remain on and the chamber can be unloaded. Leave the fans on until the product cools to below 300 °C. If the product is to be left off unattended, isolate it from the electrical supply.

5.2 Emergency Stop Button

Pushing the emergency stop button will stop the hearth from moving and prevent the elements from heating.

Once the button has been pushed, twist the emergency stop button to reset.

5.3 General Operating Advice



Heating element life is shortened by overheating. Do not leave the product at high temperature when it is not required. The maximum temperature is shown on the product rating label and in section 11.0 towards the back of this manual.

When heating large objects, in particular poor conductors, avoid shielding the thermocouple from the heating elements. The thermocouple is intended to sense the temperature near the heating elements. However, if a large object is placed in the chamber it may record the average temperature of the object and the elements, this can lead to overheating of the elements. Allow large objects to gain heat at a lower temperature and then reset the controller to a temperature close to the desired maximum, or heat using a slowly controlled ramp rate. For more information refer to the controller instructions.

The product's elements are very susceptible to mechanical shock. Take great care when loading or unloading the chamber. If it is necessary to load or unload work at elevated temperatures, keep the door open for as short a period as possible. The insulation cools quickly and may crack through thermal shock.

For improved insulation and element life it is recommended to heat and cool at a slow ramp rate e.g. 5 °C/minute, and to avoid opening the door at high temperatures.

On first installing the elements and on subsequent element replacement, operate the product at 1500 °C for an hour to create a protective glaze on the element surface.

5.4 Atmospheres & Corrosive Materials

In oxidising atmospheres, metal oxides react with the silica layer on the surface of the elements and may lead to premature failure. Protect the elements from splashes of molten metal and dust when loading the furnace and from fumes developed when melting, especially from fluxes. Also avoid compounds with a high alkali content.

The furnace is designed for use up to its maximum temperature in oxidising atmospheres, but can be operated successfully in neutral or carburising atmospheres. It may be used with nitrogen, argon or helium atmospheres to 1600 °C. Reducing atmospheres are not recommended. Sulphur dioxide is not harmful in low concentrations. However chlorine and fluorine attacks oxidised elements and should be avoided. A harmful gas is produced and collects in poorly ventilated spaces.

The furnace is not recommended for burning off carbonaceous materials. Other Carbolite Gero furnaces are available for this application.

When an optional gas inlet is fitted there is a label near the inlet saying "INERT GAS ONLY".

The chamber is not gas tight, the gas usage may be high and the chamber is always likely to contain some air. Residual oxygen of approximately 1% to 2% is to be expected.

Periodically operate the furnace in air at 1500 °C for an hour to ensure the protective glaze on the elements surface is maintained.

The hearth can be protected from abrasion, if required, by the provision of a secondary plate. This consumable item can either be in lightweight ceramic fibre or in dense, hard-wearing alumina refractory.

5.5 Operator Safety



This product incorporates a safety switch which interrupts the heating element circuit when the furnace is opened. This prevents the operator touching a live heating element and also prevents the product from heating up if the furnace is left open. The operation of this switch should be checked periodically.



Depending on use, the surfaces in the working chamber and the chamber load may still be very hot after the appliance is switched off. Touching these surfaces may cause burns. Use suitable personal protective equipment or wait until the appliance cools down to ambient temperature.

Before removing a hot object from the product, make sure there is a safe place to put it down. If necessary use tongs, face masks and heat resistant gloves. Heat resistant clothing and face protection can guard against the effects of radiated heat when the furnace is open.

When the product is opened during operation there is considerable radiated heat. Do not keep any flammable objects near the product, nor objects which could be damaged by radiated heat.

5.6 Notes on Temperature Control

This product is designed for heating and cooling at controlled rates. The heating and cooling rates can be set in the temperature programmer. The programmer enables the furnace to heat or cool at slower rates as desired and variable "hold" (dwell) periods can be programmed as required.

The programmer is used in conjunction with a phase angle thyristor power controller, which incorporates a current limit potentiometer pre-set by Carbolite Gero, but which will require adjustment in the event of change of supply voltage.

The elements are connected in series across the low voltage output of a transformer housed in the furnace case. Molybdenum disilicide elements do not age, if an element fails it is not necessary to replace the complete set.

5.7 Insulation Cracking

In these furnaces the insulation material is susceptible to surface cracking as a result of high temperature cycling; this is a normal occurrence and such cracking is not detrimental to the performance of the furnace.

5.8 Thermocouple Warnings

(1) The output from 1700-1800 °C thermocouples when used regularly at temperatures greater than 1650 °C can deteriorate and decrease with age faster than if used at temperatures below 1650 °C; this will cause the furnace to operate at temperatures higher than indicated.

Operators are advised to periodically check the thermocouple output, either by a calibration test or by comparing the output with a new reference thermocouple which has been subjected to high temperatures for a minimum length of time.

Failure to check the thermocouple regularly may result in overheating of the work and the furnace, with consequential damage to both.

(2) The thermocouples fitted to these models give very low outputs below approximately 600 °C and do not give accurate readings at low temperatures. They may show a negative temperature when the furnace is started from cold.

This furnace is not intended to operate with a setpoint below 600 °C.

5.9 Inverted Crucible Option

Take special care over safety considerations: ensure that there is a safe surface on which to place the crucible when hot. If the process permits, avoid lowering the hearth when the chamber is hot.

Depending on the height of the work-piece, it may be necessary to hold the crucible up in the chamber when placing the work-piece on the hearth; ensure that appropriate tongs are available before starting.

Clamp Option

This option assists the placing of the crucible over tall work-pieces. The "clamp" is provided in the form of a support shelf which can be fitted to a hinge on the case and a pair of insulated tongs.

With the hearth lowered, place the support shelf on the hinge and swing to the side. Use the tongs to lift the crucible up into the chamber, swing the shelf to the centre and lower the crucible.

Place the work-piece. Reverse the procedure above and carefully lower the crucible over the work-piece. Remove the shelf before raising the hearth.

5.10 Element Protection Tube Option

For application where the material being heated may give off fumes or splash, an inverted crucible can be fitted to protect the elements that is permanently located in the furnace body.

The tubes utilised for element protection within the BLF range of furnaces are fragile and extreme care should be taken when handling them.

6.0 Maintenance

6.1 General Maintenance

Preventive rather than reactive maintenance is recommended. The type and frequency depends on the product use; the following are recommended.













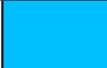

6.2 Maintenance Schedule

 CUSTOMER

 QUALIFIED PERSONNEL



DANGER! ELECTRIC SHOCK. Risk of fatal injury. Only electrically qualified personnel should attempt these maintenance procedures.

Maintenance Procedure	Method	Frequency				
		Daily	Weekly	Monthly	Bi-Annually	Annually
Safety						
Safety Switch Function	Set a safe temperature above ambient, and lower the hearth to see if the heater light goes out					
Safety Switch Function	While lowering or raising the hearth operate the emergency stop button to prove that it functions correctly.					
Safety Switch Function	Check that the hearth will not raise or lower with the cage open.					
Safety Switch Function	Electrical measurement 					
Over-Temperature Safety Circuit (if fitted)	Set an over-temperature setpoint lower than the current displayed temperature and check for an over-temperature alarm as detailed in this manual					
Over-Temperature Safety Circuit (if fitted)	Electrical measurement 					
Hearth	Visual inspection, checking the seal and whether it is free of damage					
Hearth	Replacement where necessary					
Cooling Fans (if fitted)	Check whether the cooling fans are working					
Chimney / Extraction	Check and clean if necessary					
Electrical Safety (external)	Visual check of external cables and plugs					
Electrical Safety (internal)	Physically check all connections and cleaning of the power plate area					

Function						
Temperature Calibration	Tested using certified equipment, frequency dependent on the standard required					
Operational Check	Check that all functions are working normally					
Operational Check	Thorough inspection and report incorporating a test of all functions					
Performance						
Element Circuit	Electrical measurement					
Power Consumption	Measure the current drawn on each phase / circuit					

6.2.1 Cleaning

Soot deposits may form inside the furnace, depending on the process. At appropriate intervals remove these by heating as indicated in the General Operation Notes.



The product's outer surface may be cleaned with a damp cloth. Do not allow water to enter the interior of the case or chamber. Do not clean with organic solvents.

6.3 Calibration

After prolonged use, the controller and/or thermocouple may require recalibration. This is important for processes that require accurate temperature readings or for those that use the product close to its maximum temperature. A quick check using an independent thermocouple and temperature indicator should be made from time to time to determine whether full calibration is required. Carbolite Gero can supply these items.

Depending on the controller fitted, the controller instructions may contain calibration instructions.

6.4 After-Sales Service

Carbolite Gero Service has a team of Service Engineers who can offer repair, calibration and preventive maintenance of furnace and oven products both at the Carbolite Gero factory and at customers' premises throughout the world. A telephone call or email often enables a fault to be diagnosed and the necessary parts to be despatched.

In all correspondence please quote the serial number and model type given on the rating label of the product. The serial number and model type are also given on the back of this manual when supplied with the product.

Carbolite Gero Service and Carbolite Gero contact information can be found on the back page of this manual.

6.5 Recommended Spare Parts and Spare Parts Kit

Carbolite Gero can supply individual spare parts or a kit of the items most likely to be required. Ordering a kit in advance can save time in the event of a breakdown.

Each kit consists of one thermocouple, one sheath, one power thyristor, one door insulation piece and a set of elements, clips and braids, element clamps and insulators. Individual spare parts are also available.

When ordering spare parts please quote the model details as requested above.

6.6 Power Adjustment (Controller)

The product's controller incorporates a power limit parameter OP.Hi, which is usually inaccessible to the operator.

The correct setting for the power limit depends on the supply voltage, table given in section 10.0

6.7 Power Adjustment (Thyristor)

The current-limiting thyristor stacks which control power to the elements are fitted with an adjustable resistor which is factory set to limit the maximum current supplied. In the event of a change of supply voltage, or the fitting of a new thyristor, further adjustment may be required.

The maximum element currents for this model are listed in section 10.0. Please contact Carbolite Gero for further information.

7.0 Repairs and Replacements

7.1 Safety Warning - Disconnection from Power Supply



Immediately switch the product off in the event of unforeseen circumstances (e.g. large amount of smoke). Allow the product to return to room temperature before inspection.



Always ensure that the product is disconnected from the electrical supply before repair work is carried out.

Caution: Double pole/neutral fusing may be used in this product.

7.2 Safety Warning - Refractory Fibre Insulation



Insulation made from High Temperature Insulation Wool Refractory Ceramic Fibre, better known as (Alumina silicate wool - ASW).

This product contains **alumino silicate wool** products in its thermal insulation. These materials may be in the form of blanket or felt, formed board or shapes, slab or loose fill wool.

Typical use does not result in any significant level of airborne dust from these materials, but much higher levels may be encountered during maintenance or repair.

Whilst there is no evidence of any long term health hazards, it is strongly recommended that safety precautions are taken whenever the materials are handled.

Exposure to fibre dust may cause respiratory disease.

When handling the material, always use approved respiratory protection equipment (RPE-eg. FFP3), eye protection, gloves and long sleeved clothing.

Avoid breaking up waste material. Dispose of waste in sealed containers.

After handling, rinse exposed skin with water before washing gently with soap (not detergent). Wash work clothing separately.

Before commencing any major repairs it is recommended to make reference to the European Association representing the High Temperature Insulation Wool industry (www.ecfia.eu).

Further information can be provided on request. Alternatively, Carbolite Gero Service can quote for any repairs to be carried out either on site or at the Carbolite Gero factory.

7.3 Safety Warning - Molybdenum Disilicide Elements



Molybdenum disilicide elements form a glazed surface when heated. Internal stresses can form through heating and cooling which render the glaze fragile. The glaze can sometimes splinter into a shower of sharp particles when handled. Always wear eye protection when handling the elements.

Handle the heating elements with extreme care as they are very fragile. Also, avoid touching the heating surface (the thin part of the element), as the material is susceptible to corrosive damage from skin contact.

7.4 Temperature Controller Replacement

Refer to the controller instructions for more information on how to replace the temperature controller.

7.5 Fuse Replacement

Fuses are marked on the wiring diagram with type codes, e.g. F1, F2. For more information on fuses refer to section 10.0.

Depending on model and voltage, the different fuse types may or may not be fitted.

If any fuse has failed, it is advisable for an electrician to check the internal circuits.

Replace any failed fuses with the correct type. For safety reasons do not fit larger capacity fuses without first consulting Carbolite Gero.

The fuses are located at the cable entry point. Remove the back panel or control box back panel to gain access to the fuses.

7.6 Thermocouple Replacement

Disconnect the product from the electrical supply and remove the product's element access panel.

Make a note of the thermocouple connections. The negative leg of the thermocouple is marked blue. The "compensating" cable for 1700 & 1800 °C thermocouples is plain copper.

Disconnect the thermocouple from its terminal block.

Bend the metal, or release the thermocouple sheath; withdraw the sheath and shake out any fragments of thermocouple.

Re-assemble with a new thermocouple observing the colour coding. Ensure that the thermocouple is not twisted as it is being inserted and that the metal tag is bent back, or the screw inserted, to grip the sheath.

Refit the product's element access panel.

7.7 Element Protection Tube Option Replacement Procedure

Ensure the furnace is cold and isolated from the electrical connection.

On the underside of the front cowl is a stainless steel mesh, which should be removed for access to the underside of the furnace.

You will see three crescent shaped stainless steel brackets which will support the protection tube once in place; these should be removed by loosening the two screws that hold each of them in place. Care should be taken as insulation may fall if unsupported during the removal of the sections.

Once the insulation sections have been removed, pass the tube up through the hole in the bottom of the furnace and locate within the recess of the furnace roof.

Once correctly located, re-fit the insulation sections and the corresponding brackets.

Re-fit the stainless steel mesh guard to the underside of the furnace.

7.8 Insulation Replacement

After any replacement of insulation material, operate the product at 1500 °C to burn off volatile matter. Do this in a well ventilated area.

7.9 Element Installation and Replacement



See section 7.3 - Safety Warning - molybdenum disilicide.



Molybdenum disilicide elements form a glazed surface when heated. Internal stresses can form through heating and cooling which render the glaze fragile. The glaze can sometimes splinter into a shower of sharp particles when handled. Always wear eye protection when handling the elements.

Handle the heating elements with extreme care as they are very fragile. Also, avoid touching the heating surface (the thin part of the element), as the material is susceptible to corrosive damage from skin contact.

Remove the element access cover (see section 2.1).

Remove the aluminium braids and clips using fingers or the clip tool provided, depending on the type of clip (or remove the combined clips and braids, if supplied). Lift out the old element and the insulation block: handle the block with care as it is fragile. Remove the clamps.

Handle the heating elements with extreme care as they are VERY FRAGILE. Also, avoid touching the heating surface (the thin part of the element).

Carefully unpack the elements and insert them into the insulation blocks. Fix the clamps 45 mm (BLF 17/8) or 30 mm (all other models) from the end of the element as shown in the image below.

Insert the new element; refer to the element connection diagram. Single phase models have all the elements connected in series. Reconnect the braids. Ensure that no braids of clips are touching each other or touching any other furnace parts.

After installing new elements operate the furnace at 1500 °C for an hour. This creates a protective glaze on the element surface.

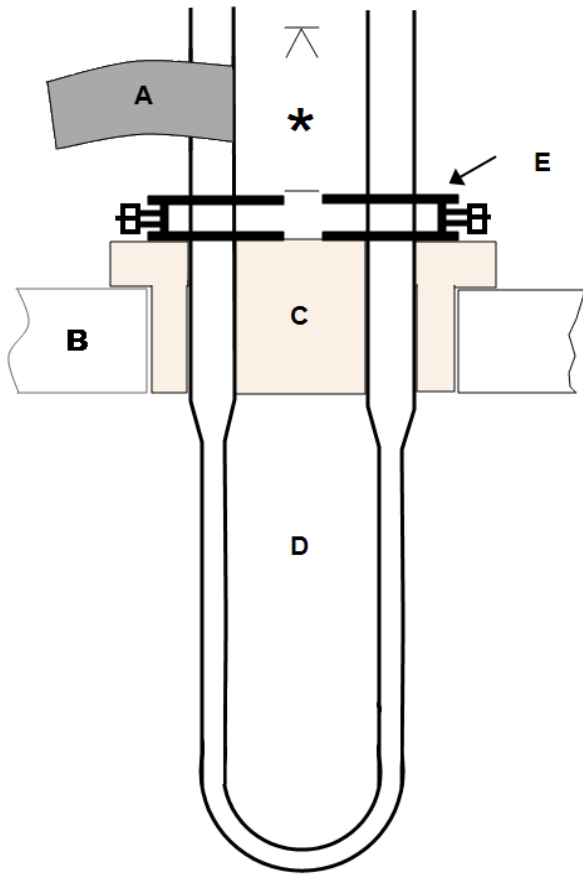

Key	
A	Braid
B	Roof Insulation
C	Element block
D	Element
E	Element Clamp
*	See text



Key	
A	Clip
B	Braid

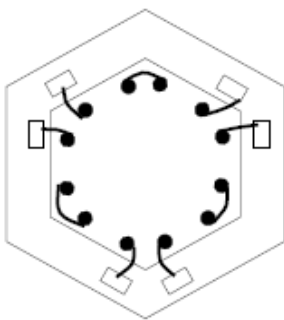

*Element Connections
 (3-phase example)*

Use of Clip Tool

The distance from the top of the element clamp to the top of the element should be 40 mm.

Larger clips require the clip tool, comprising two levers:

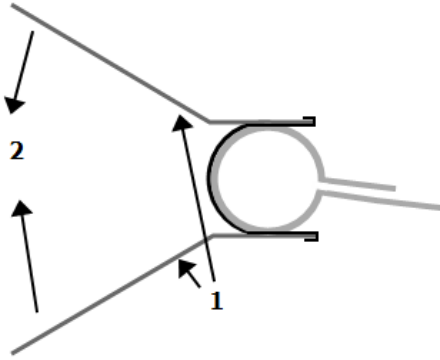

1. Clip tool
2. Apply hand pressure

8.0 Fault Analysis

A. Furnace Does Not Heat Up				
1.	The HEAT light(s) are ON.	▶	An ohm meter applied to the element circuit shows an open circuit.	▶ A heating element has failed.
2.	The HEAT light(s) are OFF.	▶	The controller shows a very high temperature or a code such as S.br.	▶ The thermocouple has broken or has a wiring fault.
		▶	The controller shows a low temperature.	▶ The door switch may be faulty or need adjustment.
				▶ The thyristor fuse may have blown.
				▶ The power thyristor could be failing to switch on due to internal failure, faulty wiring from the controller, or fault controller.
		▶	There are no lights glowing on the controller.	▶ Check the supply fuses and any fuses in the product control compartment.
				▶ The controller may be faulty or not receiving a supply due to a faulty switch or a wiring fault.

B. Product Overheats					
1.	The HEAT light goes OFF with the instrument switch.	▶	The controller shows a very high temperature.	▶	The controller is faulty.
		▶	The controller shows a low temperature.	▶	The thermocouple may have been shorted out or may have been moved out of the furnace.
				▶	The thermocouple may be connected the wrong way around.
				▶	The controller may be faulty.
2.	The HEAT light does not go off with the instrument switch and the fault persists when a 2 A control fuse is removed from its fuse-holder.	▶	The power thyristor has failed "ON".	▶	Check for an accidental wiring fault which could have overloaded the thyristor. <i>Isolate the furnace if this fault persists.</i>

9.0 Wiring Diagrams

9.1 195-1-1013

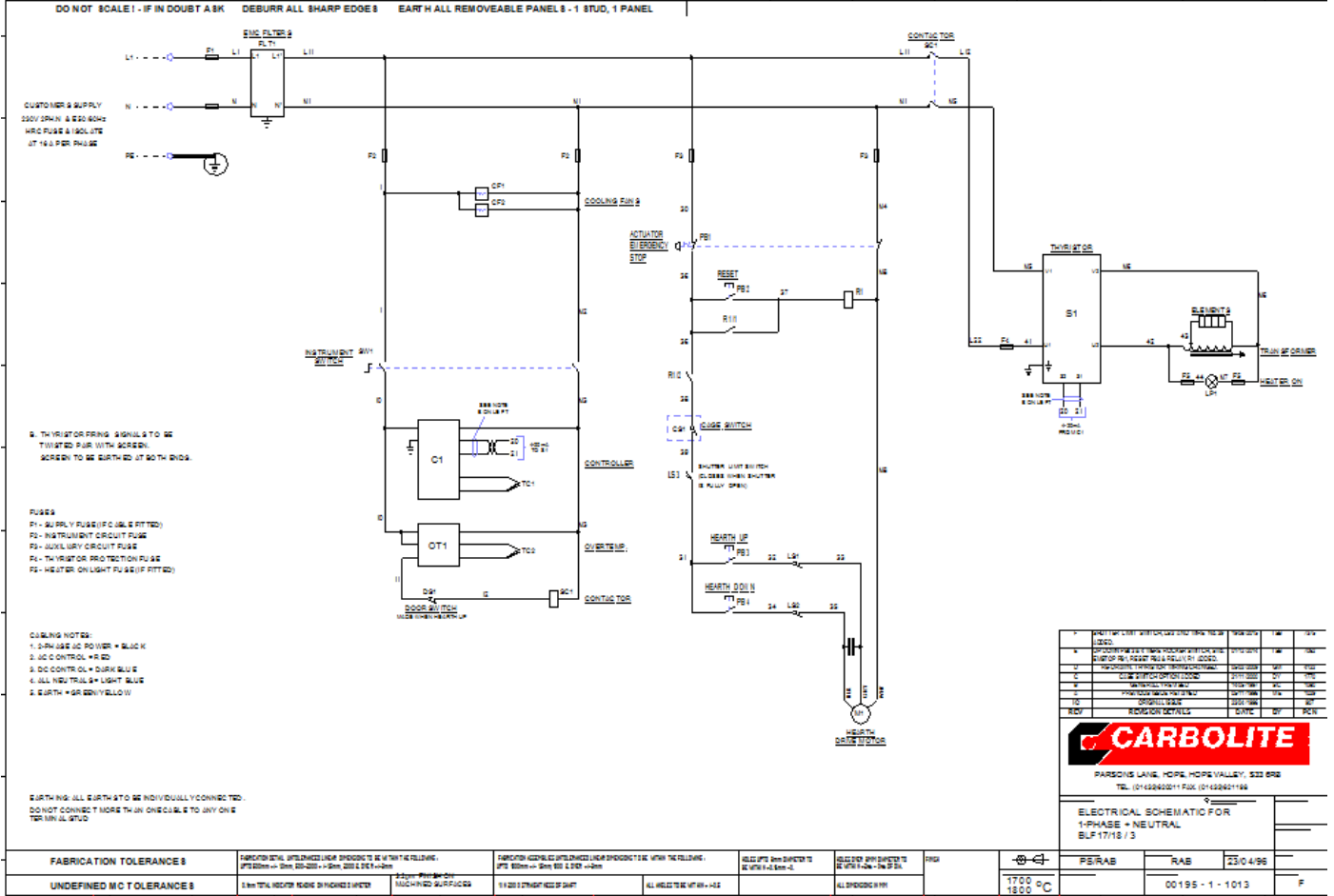

10.0 Fuses and Power Settings

10.1 Fuses

F1 to F3 - Refer to the circuit diagrams.

F1	Internal Supply Fuses	Fitted if supply cable fitted. Fitted on board to some types of EMC filter.	GEC Safeclip of the type shown (glass type F up to 16 A) 38 mm x 10 mm type F fitted on EMC filter circuit board(s)
F2	Auxiliary Circuit Fuses	Fitted on board to some types of EMC filter. May be omitted up to 25 Amp/phase supply rating.	2 Amps glass type F On board: 20 mm x 5 mm Other: 32 mm x 6 mm
F3	Heat Light Fuses	May be omitted up to 25 Amp/phase supply rating.	2 Amps glass type F 32 mm x 6 mm
	Thyristor Fuse		Ferraz Protistor of the rating shown
	Customer Fuses	Required if no supply cable fitted. Recommended if cable fitted.	See rating label for current; See table below for fuse rating.

Model	Phases	Volts	Supply Fuse Rating	Type	Thyristor Fuse Rating	Current Limit (Element Circuit)
BLF 18/3	1-phase	208 V	32 A	NS32	50 A	135 A
BLF 18/3	1-phase	220 V	25 A	NS32	50 A	135 A
BLF 18/3	1-phase	230 V	25 A	NS32	50 A	135 A

10.2 Power Settings

The power limit settings (parameter OP.Hi) for this model are voltage dependant. The figures represent the maximum percentage of time that controlled power is supplied to the elements. Do not attempt to "improve performance" by setting a value higher than the recommended values. To adjust the parameter refer to the "Changing the Maximum Output Power" of the control section of the manual.

The setting for the power limit parameter in the controller (OP.Hi) should be 100% for this product.

Please refer to the rating label for product specific information.

Please refer to the rating label for product specific information.

11.0 Specifications

Carbolite Gero reserves the right to change the specification without notice.

Model	Max Temp (°C)	Max Power (kW)	Chamber Size (mm)		Approx. Capacity (l)	Net Weight (kg)
			Height	Diameter		
Bottom Loading Furnaces heated by Molybdenum Disilicide elements, with electrically operated hearth.						
BLF 18/3	1800	4.8	190	150	3	155

11.1 Environment

The models listed in this manual contains electrical parts and should be stored and used in indoor conditions as follows:

Temperature: 5 °C - 40 °C

Relative humidity: Maximum 80 % up to 31 °C decreasing linearly to 50 % at 40 °C

Service Record

Engineer Name	Date	Record of Work

ProductLabel

The products covered in this manual are only a small part of the wide range of ovens, chamber furnaces and tube furnaces manufactured by Carbolite Gero for laboratory and industrial use. For further details of our standard or custom built products please contact us at the address below, or ask your nearest stockist.

For preventive maintenance, repair and calibration of all furnace and oven products, please contact:

Carbolite Gero Service

Telephone: + 44 (0) 1433 624242

Fax: +44 (0) 1433 624243

Email: ServiceUK@carbolite-gero.com

Carbolite Gero Ltd,

Parsons Lane, Hope, Hope Valley,
S33 6RB, England.

Telephone: + 44 (0) 1433 620011

Fax: + 44 (0) 1433 621198

Email: Info@carbolite-gero.com

www.carbolite-gero.com

CARBOLITE
GERO 30-3000°C

Copyright © 2018 Carbolite Gero Limited