

Installation, Operation and Maintenance Instructions 1200°C G-Range Tube Furnace - GHA Model: 1200mm 3508 Controller

GHA 12/1200 + 3508 Controller

Contents

This manual is for guidance on the use of the Carbolite Gero product specified on the front cover. This manual should be read thoroughly before unpacking and using the furnace or oven. The model details and serial number are shown on the back of this manual. Use the product for the purpose for which it is intended.

1.0	Symbols and Warnings	5
1.1	Switches and Lights	5
1.2	General Warnings	5
2.0	Installation	6
2.1	Unpacking and Handling	6
2.2	Siting and Setting Up	6
2.3	Work Tubes and Fittings	8
2.4	Electrical Connections	10
2.5	Reconfiguring and Adjusting for Voltage	12
3.0	3508 Controller	13
3.1	PID control	13
3.2	3508P1	13
3.3	3508P10	13
3.4	3508P25	13
3.5	Basic Operation	14
3.5.1	Controller Layout	15
3.5.2	Keys	15
3.6	Quick Start Guide	15
3.6.1	Operation as a simple controller	15
3.6.2	Changing the Setpoint	15
3.6.3	Resetting the programmer	16
3.6.4	Understanding User Levels	16
3.7	Setting Up Controller	17
3.7.1	Maximum output power setting	17
3.7.2	Customer ID.	17
3.7.3	Units	18
3.7.4	Language	18
3.8	Programming	18
3.8.1	Programming Notes	18
3.8.2	Holdback	19
3.8.3	Wait Segments	19
3.8.4	Program Cycling	20
3.8.5	Creating a Program	20
3.8.6	Running a Program	21

3.8.7	To pause (hold) a program	22
3.8.8	To stop and reset a program	22
3.8.9	To run a different program (P10 and P25)	22
3.8.10	Program Status	22
3.8.11	Program Hold with Holdback	23
3.8.12	Power Failure Recovery	23
3.8.13	Alarms	23
3.8.14	Program Example 1	24
3.8.15	Program Example 2	26
3.9	Controller Options	28
3.9.1	Digital Communications - RS232	29
3.9.2	Digital Communications - RS485	29
3.9.3	Comms Address	29
3.9.4	Alarm Option	29
3.9.5	Remote Input and Output (Analogue Communications)	30
3.9.6	Program segment output	30
3.10	Temperature Controller Replacement	31
3.11	Controller Navigation Diagrams	31
3.11.1	Operator Level 1 - No Program Running	32
3.11.2	Operator Level 1 - Program Running	33
3.11.3	Supervisor Level 2	34
4.0	3508 Dual Loop Cascade Control (if fitted)	35
4.1	Principle of Cascade Control	35
4.2	Operation of Cascade Control	35
4.3	Bypassing Cascade Control	39
4.4	3508P1 Element Loop (Loop 2)	39
4.5	Caution	39
4.6	Over-Temperature Control	39
5.0	2132 Over-Temperature Controller Description (if fitted)	40
5.1	Description	40
5.2	Operation	40
5.2.1	Controls	40
5.2.2	Operation	41
5.2.3	Over-Temperature Operation	41
5.2.4	Over-Temperature Alarm	41
5.2.5	Resetting the Over-Temperature Alarm	41
5.2.6	Sensor Break	41
5.3	Audible Alarm	42

5.4	Navigation Diagram	42
6.0	Operation	43
6.1	Operating Cycle	43
6.2	General Operating Advice	43
6.3	Operator Safety	43
6.4	Tube Life	44
6.5	Pressure	44
6.6	Gas Tightness	45
6.7	Running at Low Temperatures	45
7.0	Maintenance	46
7.1	General Maintenance	46
7.2	Maintenance Schedule	46
7.2.1	Cleaning	48
7.3	Calibration	48
7.4	After-Sales Service	48
7.5	Recommended Spare Parts and Spare Parts Kit	48
8.0	Repairs and Replacements	49
8.1	Safety Warning - Disconnection from Power Supply	49
8.2	Safety Warning - Refractory Fibre Insulation	49
8.3	Temperature Controller Replacement	49
8.4	Solid-state Relay Replacement	50
8.5	Thermocouple Replacement	50
8.6	Element Replacement	51
8.7	Fuse Replacement	52
9.0	Fault Analysis	53
A.	Furnace Does Not Heat Up	53
B.	Product Overheats	54
10.0	Wiring Diagrams	55
10.1	WA-11-31	55
10.2	WA-U3-31	56
11.0	Fuses and Power Settings	58
11.1	Fuses	58
11.2	Power Settings	59
12.0	Specifications	60
12.1	Environment	60

1.0 Symbols and Warnings

1.1 Switches and Lights



Instrument switch: when the instrument switch is operated the temperature control circuit is energised.



Heat light: the adjacent light glows or flashes to indicate that power is being supplied to the elements.

1.2 General Warnings



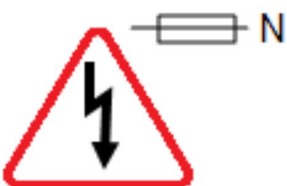
DANGER – Electric shock. Read any warning printed next to this symbol.
WARNING: Risk of fatal injury.



DANGER – Hot surface. Read any warning printed next to this symbol.
WARNING: All surfaces of a product may be hot.



DANGER – Read any warning printed next to this symbol.



Caution – Double Pole/Neutral Fusing

2.0 Installation

2.1 Unpacking and Handling

When unpacking or moving the product always lift it by its base or by both ends of the main body. Never lift it by its work tube or the surrounding insulation. Use two or more people to carry the product and control box. Remove any packing material from inside the product before use.

If an optional or special stand is separately supplied, assemble the product on to it. Some models may be supplied for customer mounting and may require customer preparation of mounting components before installation.



NOTE: This product contains Refractory Ceramic Fibre (also known as Alumino Silicate Wool - ASW). For precautions and advice on handling this material see section 8.2.

2.2 Siting and Setting Up

Place the product on a level surface in a well ventilated area.

Site away from other sources of heat and on a non-flammable surface that is resistant to accidental spillage or hot materials.

The surface on which the equipment is mounted should be stable and not subject to movement or vibrations.

The height of the mounting surface is important to avoid operator strain when loading and unloading samples.

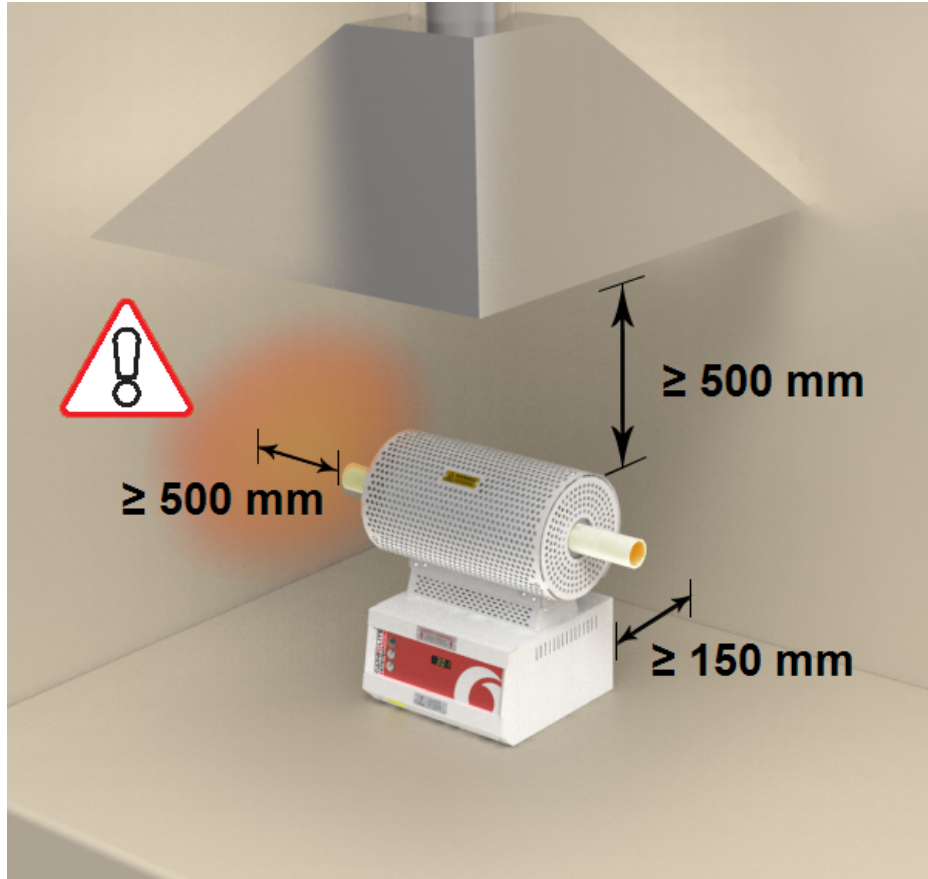
Unless otherwise stated elsewhere in this manual, ensure that there is **at least 150 mm** of free space around the back and sides of the product. Clear space is required above the product to dissipate heat.

Work tubes:



It is recommended that the work tube has either insulation plugs or radiation shields fitted to minimise heat loss from both ends of the work tube. If the work tube has open ends, a significant amount of energy could be radiated from the ends of the work tube. Adjacent surfaces should always be made from a non-flammable material.

Ensure that the ends of the work tube are positioned **at least 500 mm** away from any adjacent surface so that any energy radiated cannot heat an adjacent surface to a dangerous temperature.



Ensure that the product is placed in such a way that it can be quickly switched off or disconnected from the electrical supply.

This horizontal tube product is supplied with the controls in an integral base (or, to order, with the base control panel blanked off and the controls in a separate box). A horizontal tube support kit.

All G-range tube furnaces have "modular" heating elements in which resistance wire is partially embedded in vacuum formed light-weight refractory fibre. The modules are 150 mm long. In all standard models the two end elements (one at each end) are rated at 1170 W maximum, while the other (centre) elements are rated at 780 W.

All models are supplied with a pair of "tube adaptors", which can be made to suit any work tube size up to 170 mm outside diameter. Spare or replacement adaptors can be ordered.

The horizontal models generally require no special setting up. Observe the above paragraph on siting. See section 2.3 for work tube and end adaptor considerations.



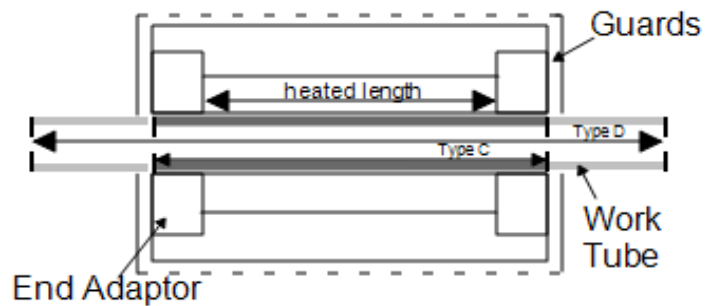
Under no circumstances should any objects be placed on top of the product. Always ensure that any vents on the top of the product are clear of any obstruction. Always ensure all cooling vents and cooling fans (if fitted) are clear of any obstruction.

2.3 Work Tubes and Fittings

Tubes of various diameters and lengths may be fitted.

Type C: minimum length for the product.

Type D: 400 mm longer than C, to allow for the fitting of end seals.



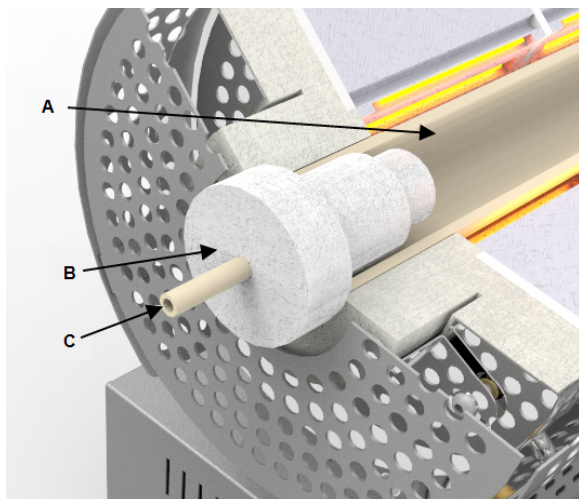
A pair of removable 'end adaptors' form part of the end insulation. These may be blank (no hole) or may have a hole to suit a work tube, depending on the customer order. Additional adaptors may be ordered to suit different work tube sizes. Check that the end adaptors are correct for the tube: if not, seek advice from Carbolite Gero. Small alterations to the hole in the adaptors may be made with a file, but first read the section on ceramic fibre safety 8.2. To insert a work tube it is often convenient to use a long pole (such as a broom handle) to guide it into the far end of the product.

For optimum temperature uniformity, insulating plugs should be placed in the tube ends as shown in fig.1. With a long work tube, the stem of the plug assembly should line up with the end of the tube as in fig.2. Alignment of radiation shields is similar to that of plugs.

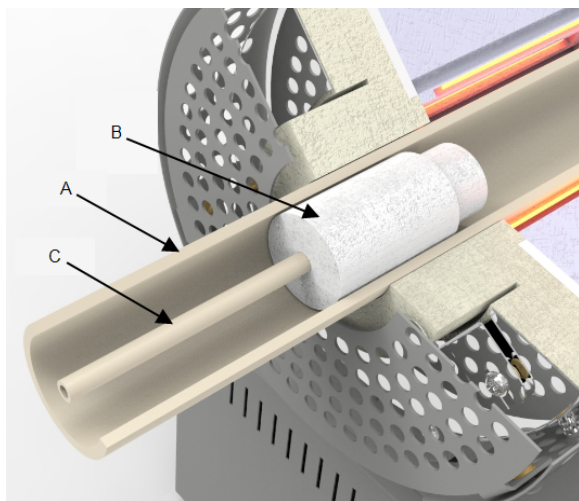
If stainless steel seals with gas inlets are supplied, they are to be fitted as shown in fig.3; the stem of any insulating plug should touch the seal.

Horizontal use: if heavy fittings are to be clamped to the end of an extended work tube they can increase the bending stress at the centre of the tube. Support such fittings in such a way that expansion of the tube is allowed. A horizontal tube support kit can be supplied for this purpose.

If a metal work tube is being used in the product, ensure that it is earthed. See the "Safety Warning" under "Operator Safety".

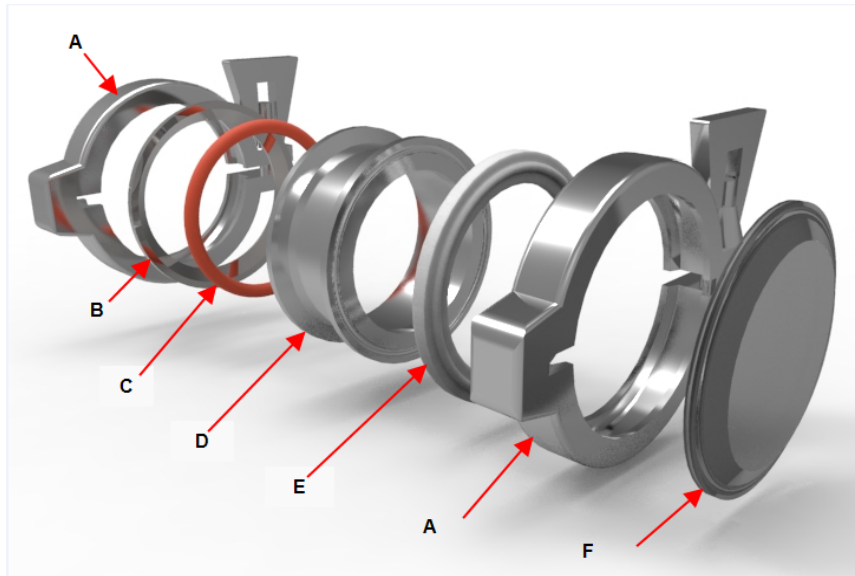


**Fig 1 - Insulating Plug
(standard length tube)**

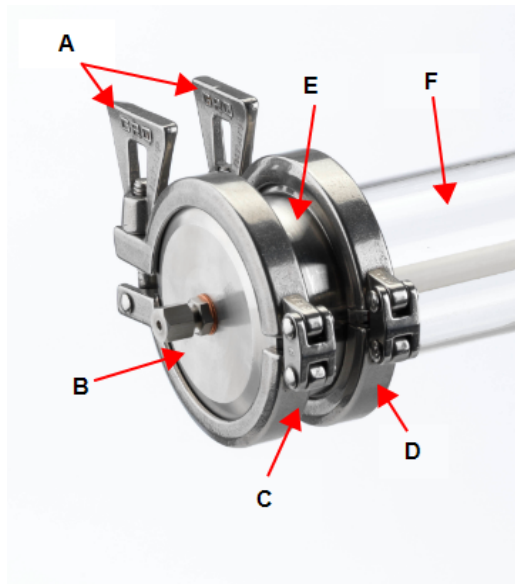


**Fig 2 - Insulating Plug
(long work tube)**

Key	
A	Tube
B	Insulating Plug
C	Stem



Key	
A	Clamp
B	Seal plate
C	'O' Ring seal
D	Seal sleeve
E	Clamp seal
F	End plate



Key	
A	Clamp
B	End plate
C	Clamp seal (between Seal sleeve and Clamp)
D	Seal sleeve
E	Seal plate & 'O' Ring seal (underneath clamp)
F	Tube

Fig 3 'Twin Clamp' End Seal

For assembly details refer to the separate work tube end seal manual.

2.4 Electrical Connections



Connection by a qualified electrician is recommended.

All models covered by this manual may be ordered for single phase A.C. supply, which may be Live to Neutral non-reversible, Live to Neutral reversible or Live to Live.

Check the product rating label before connection. The supply voltage should agree with the voltage on the label and the supply capacity should be sufficient for the current on the label.

The supply should be fused at the next size equal to, or higher than the current on the label. A table of the most common fuse ratings is also given towards the back of this manual. When the mains cable is factory fitted, internal fuses are also fitted. It is essential that the operator ensures that the product is correctly fused.

Products with a factory fitted supply cable are designed to be wired directly to an isolator or fitted with a line plug.

Products without a factory fitted supply cable require a permanent connection to a fused and isolated supply. The product's electrical access panel should be temporarily removed, and connections made to the internal terminals.

If the product is to be connected by line plug. The plug should be within reach of the operator and should be easy to remove.

When connecting the product to an isolating switch ensure that both conductors (single phase) or on all live conductors (three phase), and should be within reach of the operator.

The supply **MUST** incorporate an earth (ground).

Electrical Connection Details:

Supply	Terminal Label	Cable Colour	Supply Types	
			Live - Neutral	Reversible or Live-Live
1-phase	L	Brown	to live	to either power conductor (For USA 200-240V, connect L1)
	N	Blue	to neutral	to the other power conductor (For USA 200-240V, connect L2)
	PE	Green/ Yellow	to earth (ground)	to earth (ground)

2- or 3-phase	L1	Black	to phase 1
	L2	Black	to phase 2
	L3	Black	to phase 3 (except 2-phase)
	N	Light Blue	to neutral (except delta)
	PE	Green/ Yellow	to earth (ground)

2.5 Reconfiguring and Adjusting for Voltage

The standard single-phase models can operate over the voltage range 200 - 240 V. The 2-phase models can operate over the range 380/220 V to 415/240 V. The 3-phase models can operate over the range 380/220 V to 415/240 V.

The product is wired according to the original order and conversion from 1-phase to 2-phase or 1-phase to 3-phase is not possible. To check for voltage setting within the appropriate range, or to change to another setting, follow the instructions in section 11.0.

Special Voltages

The products can be specially made to suit certain special voltages, such as 440/254 or 480/277.

Due to unbalanced phases, the furnaces cannot be made to suit 3-phase without neutral of 380 V or above.

Products made for special voltages are generally not convertible between configurations and voltages.

3.0 3508 Controller

3.1 PID control

This controller uses PID (Proportional Integral Derivative) temperature control. This type of control uses a complex mathematical control system to adjust the heating power and achieve the desired temperature.

3.2 3508P1

The 3508P1 is a digital temperature controller which uses PID algorithm to give excellent temperature control when properly set. This controller can store and operate a single program of up to 20 segments. The 3508P1 can also be used as a simple temperature controller.

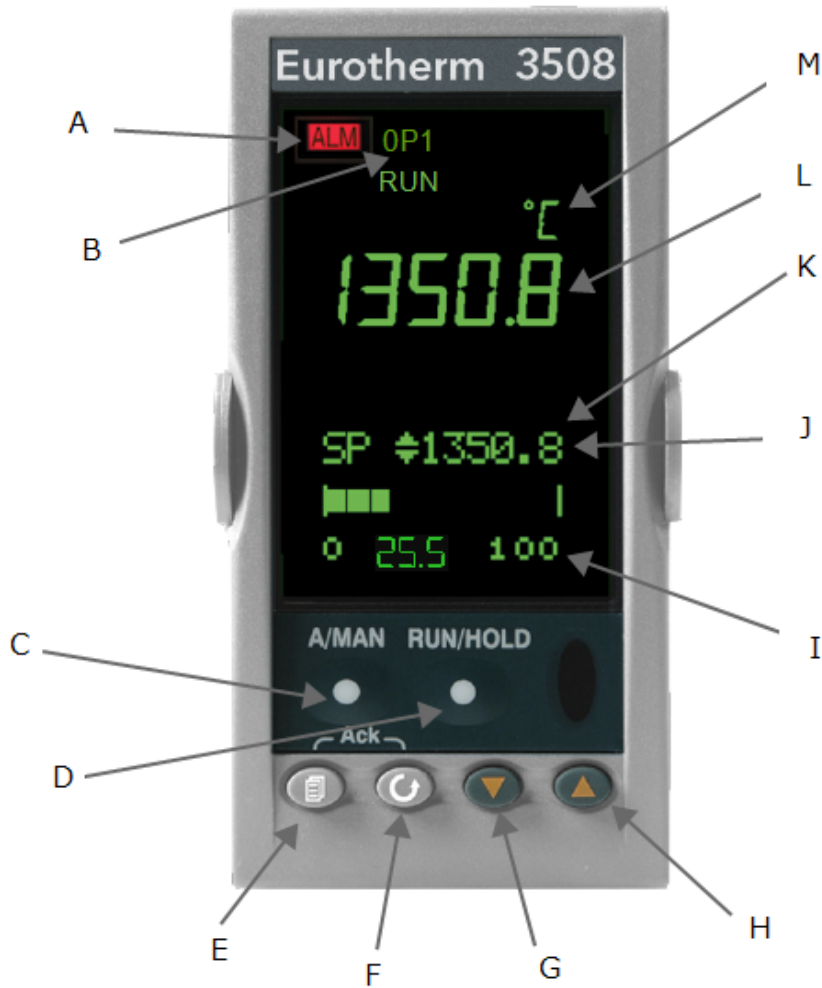
3.3 3508P10

The 3508P10 is a digital controller which uses PID algorithms to give excellent temperature control when properly set. This controller can store 10 programs of up to 50 segments each. Programs can be operated individually or linked by a Call parameter as sub-programs or to form single long programs. The 3508P10 can also be used as a simple temperature controller.

3.4 3508P25

The 3508P25 is a digital temperature controller which uses PID algorithms to give excellent temperature control when properly set. This controller has a maximum of 500 segments or 25 programs; each program has a maximum of 50 segments. For example 3508P25 could store 10 programs with 50 segments or 25 programs with 20 segments. Programs can be operated individually or linked by a Call parameter as sub-programs or to form single long programs. The 3508P25 can also be used as a simple temperature controller.

3.5 Basic Operation









Key	
A	Alarm Indicator
B	Power Output Indicator
C	Not Used
D	Runs, Holds, Resets the current program
E	Page
F	Scroll
G	Down
H	Up
I	Power Output Percentage
J	Program Setpoint Temperature (PSP) when a program is running
K	Setpoint Temperature (SP) when basic controlling

L	Measurement Temperature
M	Measurement Units

3.5.1 Controller Layout

3.5.2 Keys

A/ Man	-	Disabled
RUN/ HOLD	-	Runs, Holds or Resets the current program. Hold down for 3 seconds to Reset.
Page Key		Scrolls through the page headings. Hold down for 3 seconds to access further levels, pass codes are required.
Scroll Key		Scrolls through parameters listed on pages.
Arrow Keys		Adjust parameter values.
Page and Scroll together		Press together to return to the home display or to acknowledge an alarm.
Page and Up together		Press together quickly to scroll back up the page headings.
Scroll and Up together		Press together quickly to scroll back up a parameter list.
Pressing any other combination of keys together has no effect.		

Note: If no keys are pressed for 1 minute, the display returns to Home.



3.6 Quick Start Guide

3.6.1 Operation as a simple controller

When switched on the controller goes through a short test routine and then shows the measured temperature. Below it, the setpoint temperature (SP) and percentage of power output.

The controller will immediately attempt to reach the set temperature and maintain it. This will cause the product to heat as quickly as possible which may not be appropriate where the product contains sensitive ceramic components. For products with ceramic components, e.g. a tube furnaces fitted with a long ceramic work tube, use the ramp rate feature set with a low heating rate such as 5°C per minute (300°C per hour), to prevent damage.

3.6.2 Changing the Setpoint

Press up  or down  to select the required SP. If the SP is higher than the measured temperature, the OP1 indicator will illuminate at the top of the display, indicating that the product is heating.

The controller will immediately attempt to reach the set temperature and maintain it. This will cause the product to heat as quickly as possible which may not be appropriate where the product contains sensitive ceramic components. For products with ceramic components, e.g. a tube furnaces fitted with a long ceramic work tube, use the ramp rate feature set with a low heating rate such as 5°C per minute (300°C per hour), to prevent damage.

3.6.3 Resetting the programmer

To reset the programmer to simple controller mode, press RUN/HOLD for 2 seconds.

Operating the current program

- To avoid unwanted heating at the end of a program, set the SP temperature to zero before operating a program.
- Ensure the programmer is reset to simple controller mode before starting a program by pressing RUN/HOLD for 2 seconds.
- To start the program, press RUN/HOLD twice, RUN will light up on the display.

The displayed Program Setpoint (PSP) follows ramps, dwells and steps as the program runs. The SP temperature of the controller does not apply when a program is operating.

- To pause the program, press RUN/HOLD.
- To stop the program and return to simple controlling (reset), press RUN/HOLD for 2 seconds.

When the program ends, the programmer will either:

- Automatically reset to operation as a simple controller.
- Dwell at the last temperature of the program (with the RUN indicator flashing), until the operator presses RUN/HOLD for 2 seconds to manually reset, or presses RUN/HOLD once to restart the program.
- Turn power to the elements down to zero.





3.6.4 Understanding User Levels

There are two levels in the controller; Level 1(Operator) and Level 2 (Supervisor).

Level 1 (Operator) is for the day-to-day operation of the controller is not protected by a security code. There are 3 pages at this level. Page 1, Customer Identity, can only be altered in level 2. Page 2 shows the current program status. Page 3 is for writing and viewing programs.



Level 2 (Supervisor) requires a security code to enter, but once enable, provides access to additional parameters. A further 4 pages are accessible in this level as follows; Home , Customer identity, Control Output Hi percentage, Units.

To Enter Level 2:

1. Press and hold page  for 3 seconds. The display will show "Access Goto Level 1"
2. Press up  to select level 2. After a short pause the display will show "Access Pass code".
3. Press up  or down  to enter the pass code. Pass is momentarily displayed. After a short pause the display will return to home, the controller is now in level 2.

When Level 2 operations have been completed the supervisor must return to Level 1 manually. It is not necessary to enter a code when going from a higher level to a lower level.




To Return to Level 1:

1. Press and hold page  for 3 seconds. The display will show "Access Goto Level 2."
2. Press down  to go to level 1. After a short pause the display will revert to home, the controller is now in level 1.

3.7 Setting Up Controller

Before using the controller (or during its lifetime) certain parameters may have to be set, depending on specific requirements. To do this the controller must be set to Supervisor Level 2, see "Controller Navigation Diagrams".

3.7.1 Maximum output power setting

Press page  until "Control Output Hi" is displayed. Press up  or down  to adjust the value.




Depending on the product model, the maximum power output setting may be accessible or locked.

For silicon carbide heated products the parameter is accessible to allow compensation for element ageing.



In many models the maximum power output setting depends on the electrical supply voltage, refer to section 11.0.

3.7.2 Customer ID.

A product identity number can be entered if required. This may be used to identify one of many units, for production or quality control systems.

Press page  until "Customer Identity" is displayed. Press up  or down  to select a number.

3.7.3 Units

Press page  until "Units" is displayed. Press up  or down  to select:

C	Celsius
F	Fahrenheit
K	Kelvin

3.7.4 Language

The text on the 3508 Controller can be shown in different languages, this can only be set at the factory and therefore must be specified at the time of placing an order.

3.8 Programming

3.8.1 Programming Notes

Programs can be created in Level 1 or Level 2 of the 3508 Controller.

For the P10 and P25, new programs can be created while the current program is operating.

To avoid unwanted heating at the end of a program, set the controller setpoint temperature to zero before operating a program.

All new unused programs show only 1 segment of type 'End'.

The minimum number of segments for a program is 2. The second being an 'End' type. Ramp-to-setpoint control. To achieve this, create a two segment program. Set the first segment type as 'Rate' or 'Time'. Set the second segment type 'End' type 'Dwell'.

For the P10 and P25, programs can be linked together using a 'Call' segment. However, a lower number program can not be called and a program can not be ended with a call segment.

A program can be ended in four ways:

1. With 'End' segment set to S.OP the power to the elements is turned down to 0%, no matter what the 'Setpoint' temperature is.
2. With 'End' segment set to 'Reset' and the 'Setpoint' temperature turned down to zero, power to the elements will be 0%. To do this set the 'Setpoint' temperature to the minimum possible. For type B thermocouples this will be below zero.
3. With the 'End' segment set to 'Reset'. The controller will try to reach and maintain the 'Setpoint' temperature in place before the program started.
4. With the 'End' segment set to 'Dwell'. The controller will dwell at the 'PSP' of the last segment ("RUN" indicator flashes), until it is reset.

To reduce the number of segments in a program, change the last required segment to an 'End' type.

You will be asked to press  to cancel or  for OK.





To cancel all segments in a program, change the first segment to an 'End' type.

To alter parameters or segments of an operating program, this program must be held or reset. Press RUN/ HOLD to pause the program, or press RUN/ HOLD for 2 seconds to reset.

3.8.2 Holdback

Holdback can be used to prevent the program from operating ahead of the actual heating or cooling.

The holdback value is the amount, in degrees, by which the program setpoint can run ahead of the measured temperature before holdback operates. The value applies to a whole program.





To set the value press page  twice, press scroll  until 'Holdback Value' appears and press up  or down  to set.

Holdback can be used in 'Rate', 'Time' and 'Step' segments.

- For 'Rate' and 'Time' segments holdback will operate during the segment.
- For a 'Step' segment holdback delays continuation to the next segment until the step target is reached.

The 'Holdback Type' can be set as follows:

• Low	Applies to heating only
• High	Applies to cooling only
• Band	Applies to both heating and cooling
• Off	Holdback is switched off

To set the holdback type, press page  twice, then press scroll  until the display shows 'Holdback Type' for each segment and press up  or down  to set.

The default setting for holdback is 'OFF'.

3.8.3 Wait Segments

Wait prevents the program proceeding to the next segment, in a similar way to holdback, until the selected 'Wait-For' parameter has been met. There are 5 'Wait For' parameters. The first 4 only work if there are configured inputs to the controller.

1. PrgIn1 Wait until Input 1 is true
2. PrgIn2 Wait until Input 2 is true
3. PrgIn 1&2 Wait until Inputs 1 AND 2 are true
4. PrgIn 1or2 Wait until Inputs 1 OR 2 is true
5. PVWaitIP Wait until the measured temperature reaches a threshold value before continuing. It can operate in one of 4 ways:
 1. 'Abs Hi' Wait until the measured temperature is greater than or equal to a value 'WaitVal' set for that segment.
 2. 'Abs Lo' Wait until the measured temperature is less than or equal to a value 'WaitVal' set for that segment.
 3. 'Dev Hi' Wait until the measured temperature exceeds a fixed* threshold by an amount 'WaitVal' set for that segment.

4. 'Dev Lo' Wait until the measured temperature drops below a fixed* threshold by an amount 'WaitVal' set for that segment.

* The fixed threshold used by deviation parameters is set in the configuration level of the programmer and if required should be requested when purchasing a product from Carbolite Gero.

3.8.4 Program Cycling

The 'Cycles' parameter sets the number of times the program will operate.

The default setting is 1 cycle.

To change the number of cycles, press page twice, then press scroll until the display shows 'Prog Cycles', then press up to set a finite number of cycles up to 999. Or press down to set cycling to continuous.

3.8.5 Creating a Program

From the home display, press page three times to get to the programming page, the display will show "ProgEdit 1".

Program number

On P10 or P25 models press up or down to select a new program number. The display will show that new programs have only one segment.

Holdback Value

Press scroll until the display shows 'Holdback Value". If required: Press up or down to set a value. This value will be used in any segment where a 'Holdback Type' is set.

Ramp Units

These apply to Rate segments only. Press scroll until the display shows 'Ramp Units'.

Press up or down to select the ramp units of degrees per Hour, Min or Sec.

Number of program cycles




Press scroll until the display shows 'Cycles'. Press up or down to select more than one cycle.

Now create all the segments for your program, finishing with an 'End' segment. When parameters for each segment have been entered the display goes to the next segment number.



Segment Type

Press scroll until the display shows 'Segment Type'. Press up or down to select 'Rate', 'Time', 'Dwell', 'Step', 'Wait', 'GoBack', 'Call' or 'End'.




Holdback Type

Press scroll  until the display shows 'Holdback Type'. If required, press up  or down  to select 'Off', 'Low', 'High' or 'Band'.


Target Setpoint (Visible only for Rate, Time and Step segments)

Press scroll  until the display shows 'Target SP'. Press up  or down  to set a value.




Ramp Rate (Visible only for Rate segments)

Press scroll  until the display shows 'Ramp Rate'. Press up  or down  to set the number of degrees per 'Ramp Unit' as set above.



Duration (Visible only for Time and Dwell segments)

Press scroll  until the display shows 'Duration'. Press up  or down  to set a value.


Wait For (Visible only for Wait segments)

Press scroll  until the display shows 'Wait For'. Press up  or down  to select: PrgIn1, PrgIn2, PrgIn1In2, PrgIn1orIn2, PVWaitIP.

GoBack to segment number (visible only for GoBack segments)

Press scroll  until the display shows 'GoBack Seg'. Press down  to select a segment number to go back to.




GoBack Cycles (visible only for GoBack segments)

Press scroll  until the display shows 'GoBack Cycles'. Press up  or down  to set a value.





Call Cycles (Visible only for call segments)

Press scroll  until the display shows 'Call Cycles'. Press up  or down  to set a value.

End Type (Visible only for End segments)

Press scroll  until the display shows 'End Type'. Press up  or down  to select: 'Reset', 'Dwell' or 'SafeOp'.

3.8.6 Running a Program


The current program can be started from the home display by pressing RUN/HOLD or by pressing page  once, then scroll  once (twice for P10 and P25), then press up  or down  to change the status to 'Run'.

3.8.7 To pause (hold) a program

Press RUN/HOLD

or

Press page  until 'Program Status Reset' appears

Press scroll  until the cursor moves to 'Reset'

Press up  or down  to select 'Hold'


RUN/HLD will be displayed

3.8.8 To stop and reset a program

Press and hold RUN/HOLD

or

Press page  until 'Program Status Reset' appears

Press scroll  until the cursor moves to 'Reset'

Press up  or down  to select 'Reset'

3.8.9 To run a different program (P10 and P25)

To select a program

Press page  until 'Program Status Reset' appears

Press scroll  then up  or down  to select a program number

To operate the program

Press RUN/HOLD

or

Press scroll  until the cursor moves to 'Reset'

Press up  or down  to select 'Run'


Run will be displayed

3.8.10 Program Status


While a program is operating the home display shows 3 values:










- Top: Measured temperature
- Centre: Program Setpoint (PSP)
- Bottom: Power output percentage

To see more detail:

Press page  once to go to the program status page. The top and centre values from the home page remain on the display. The lower half of the screen now shows:

- Current program number (P10 and P25 only)
- Current segment number
- Time remaining for that segment

Further presses of the scroll  key while a program is operating will reveal additional information:

-  Status. This can be changed to 'Hold', 'Reset' or 'Run' by pressing up  or down 
-  Program Setpoint (PSP)
-  Current Segment Type. 'Step' and 'Call' segments are instant, so are only flashed on the screen, unless holdback is operating on that segment.
-  Target Setpoint
-  Segment Rate For 'Rate', 'Time' and 'Step' segments only
-  Cycles left
-  Program Time Left

3.8.11 Program Hold with Holdback

If a holdback value has been set and the program goes into a hold state, the green HLD indicator will flash until the measured temperature catches up.

While in this condition, the program itself is put into hold by pressing the RUN/HLD button, the 'HLD' indicator will stop flashing and remain on with the 'RUN' indicator. When the program is started again by pressing the RUN/HLD button, the 'HLD' indicator will flash again if the measured temperature has not caught up with the program.

Programming note: For P10 and P25 models, other programs can be created or changed whilst the current program is operating.

3.8.12 Power Failure Recovery

If there is a power interruption to the controller during a program, when power is restored the controller pauses the program, then ramps the temperature back up to the current program setpoint (PSP) before continuing the program.

- Power failure during ramp segments: The ramp rate will be that of the current ramp segment.
- Power failure during dwell segments: The ramp rate will be that of the previous ramp segment. If a previous ramp segment does not exist, then the dwell will continue at the current measured temperature.
- Power failure during time-to-target segments: The ramp rate will be that of the current segment. The ramp rate is maintained, but the time remaining is recalculated.

If there is a power interruption while controlling to setpoint, when power is restored the controller automatically calls for maximum power.

3.8.13 Alarms

Alarms are used to alert the operator when a pre-set level has been exceeded or a function error has occurred such as a sensor break. They are indicated by a flashing red

ALM (Alarm) indicator. The alarm may also switch an output – usually a relay to allow external devices to operate when an alarm occurs. Alarms only operate if they have been configured and are dependent on customer requirements.

How to acknowledge an alarm will depend on the type of latching which has been configured. A non-latched alarm will reset itself when the alarm condition is removed. A latched alarm requires acknowledgement with the 'ACK' function before it is reset.









If an alarm has been activated, the red 'ALM' indicator will flash and the text will indicate the type of alarm.

To acknowledge an alarm and cancel the 'ALM' indicator, press and together.

3.8.14 Program Example 1

The following sequence of entries creates and runs the program shown graphically below.

1. Turn the controller SP down to '0' by pressing down .
 2. Press page until 'Prog Segments Used' is displayed. On P10 or P25 models press up or down to select a new program number, (a program with only 1 segment).
 3. Press scroll until 'Holdback Value' is displayed. Default '0' degrees.
 4. Press scroll until 'Ramp Units' is displayed. Press up or down to set to 'Min'
 5. Press scroll until 'Cycles' is displayed. Default '1'
 6. Press scroll until 'Segment 1' is displayed
 7. Press scroll until 'Segment Type' is displayed. Press up or down to select 'Rate'
 8. Press scroll until 'Holdback Type' is displayed. Default 'Off'
 9. Press scroll until 'Target SP' is displayed. Press up or down to set to '400' degrees.
 10. Press scroll until 'Ramp Rate' is displayed. Press up or down to set to '5.0' degrees per minute.
- Repeat steps 6 to 10 for 4 more segments. Set 'Holdback' to the default 'Off'. Enter the following parameters and values:
- Segment Type Dwell Duration '30:00.0' minutes
 Segment Type Step Target SP '600' degrees
 Segment Type Dwell Duration '30:00.0' minutes
 Segment Type Time Target SP '200' degrees, Duration '2:00:0' hours
- Finish the program with an 'End' segment:
11. Press scroll until 'Segment Type' is displayed. Press up or down to select 'End'

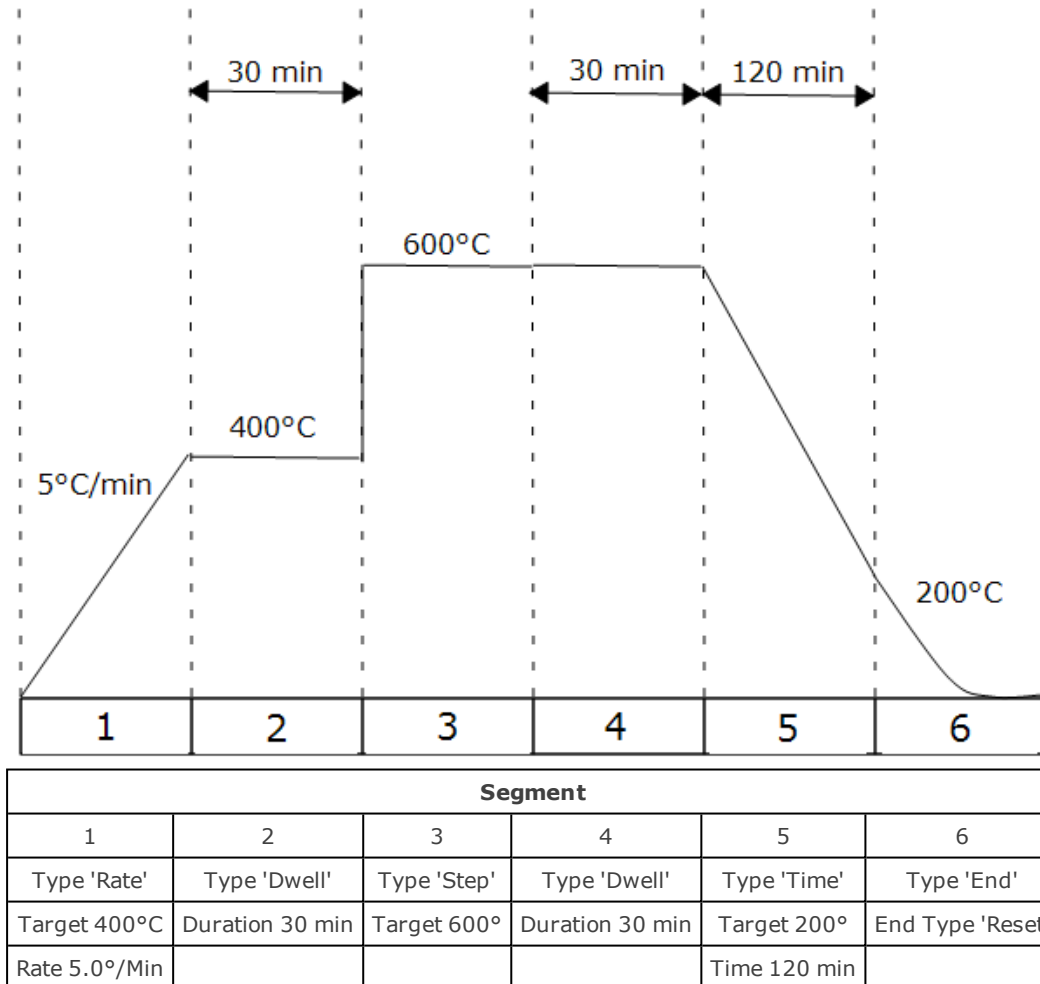
12. Press scroll  until 'End Type' is displayed. Press up  or down  to select 'Reset'
13. Press page  and scroll  together to return to the home display.
To run the program either press RUN/HOLD or:
14. Press page  until 'Program Status' is displayed
15. Press scroll  until the cursor moves to the program status of 'Reset'
16. Press  to select 'Run'.

Time Display Examples

10:05:3 Min/Sec/10th Sec




21:10:05 Hour/Min/Sec













196:10 Hour/Min



3.8.15 Program Example 2

The following sequence of entries creates and runs the program shown graphically below.












1. Turn the 'Setpoint' to '0' by pressing down ▼
2. Press page  until 'Prog Segments Used' is displayed. On P10 and P25 models press up ▲ or down ▼ to select a new program number, (a program with only 1 segment).
3. Press scroll  until 'Holdback Value' is displayed. Press up ▲ or down ▼ to set to '5' degrees
4. Press scroll  until 'Ramp Units' is displayed. Press up ▲ or down ▼ to set to 'Min'

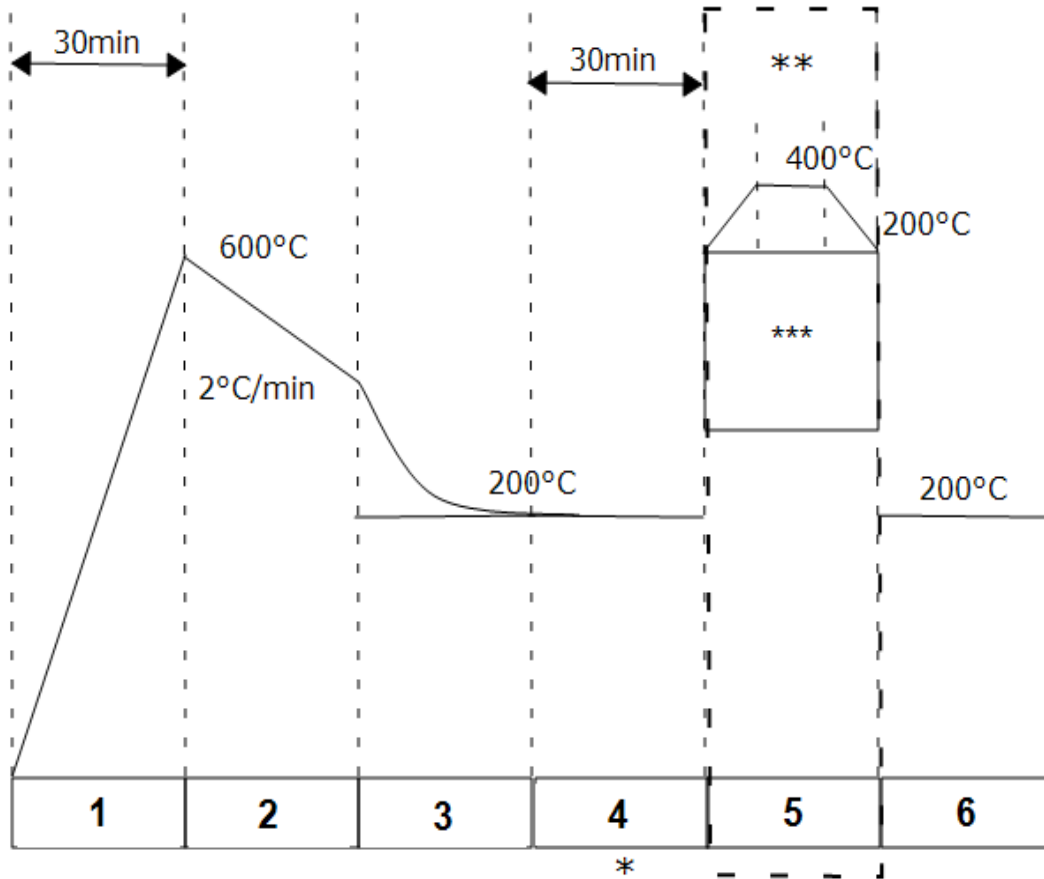
5. Press scroll  until 'Cycles' is displayed. Default '1'
6. Press scroll  until 'Segment 1' is displayed
7. Press scroll  until 'Segment Type' is displayed. Press up  or down  to select 'Time'
8. Press scroll  until 'Holdback Type' is displayed. Default 'Off'
9. Press scroll  until 'Target SP' is displayed. Press up  or down  to set to '600' degrees
10. Press scroll  until 'Duration' is displayed. Press up  or down  to set to '30:00.0' minutes

Repeat steps 6 to 10 for 4 more segments. Enter the following parameters and values:
Note: Call segments are not available on single program models.

Segment Type Rate	Target SP '400' degrees. Ramp Rate '2.0' degrees per minute
Segment Type Step	Target SP '200' degrees
Segment Type Dwell	Holdback 'High'. Duration '30:00.0' minutes
Segment Type Call	Call Prog 'next number'. Call Cycles '2'

Finish the program with an End segment:

11. Press scroll  until 'Segment Type' is displayed. Press up  or down  to select 'End'
 12. Press scroll  until 'End Type' is displayed. Press up  or down  to select 'Dwell'
- Repeat the sequence to create a short program '3' as suggested in the diagram.
13. Press page  and scroll  together to return to the home display
To operate the program either press RUN/HOLD or
 14. Press page  until 'Program Status' is displayed
 15. Press scroll  until the cursor moves to the program status of 'Reset'
 16. Press  to select 'Run'



Segment					
1	2	3	4	5	6
Type 'Time'	Type 'Rate'	Type 'Step'	Type 'Dwell'	Type 'Call'	Type 'End'
Target 600°C	Target 400°C	Target 200°C	Duration 30 min	Call prog 3	End Type 'Dwell'
Duration 30min	Rate 2°C/min		H back type 'High'	Call cycles 2n	
			* Segment 4 'Holdback Value' 5°C	** P10 and P25 only	
				*** Program 3 Example	

3.9 Controller Options

As options can be ordered in a variety of combinations and for a variety of purposes, exact instructions are not given here. The full Eurotherm manual may be required to determine customer parameter settings. To reveal or hide parameters in the controllers it is necessary to go into configuration mode, a security code is needed. Please consult Carbolite Gero.

3.9.1 Digital Communications - RS232

If the RS232 option is supplied, the furnace is fitted with one sub-miniature D-socket connected to the controller comms module. RS232 is suitable for direct connection to a personal computer (PC) using a "straight through" cable as follows (the linked pins at the computer end are recommended but may not be necessary). The cable is usually 9-pin at the furnace end and 9-pin at the computer, but other alternatives are shown in parentheses.

Product end of cable female (25-pin) 9-pin			RS232 Cable: product to PC	Computer end of cable 9-pin (25-pin) male		
Rx	(2)	3	_____	3	(2)	Tx
Tx	(3)	2	_____	2	(3)	Rx
Com	(7)	5	_____	5	(7)	Com
				7,8 1,4,6	(4,5) (6,8,20)	Link together Link together

3.9.2 Digital Communications - RS485

If an RS485 option is supplied, the furnace is fitted with two D-sockets. Connection between products is by "straight" cable as follows:

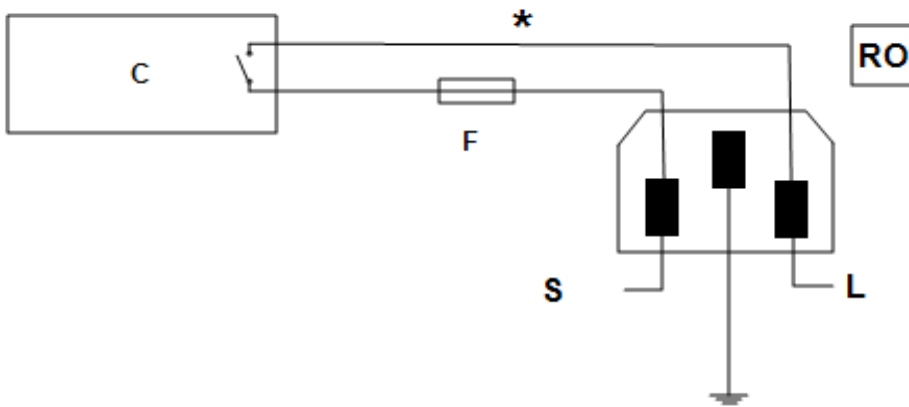
Product end of cable female (25-pin) 9-pin			RS485 Cable: product to PC	Computer end of cable 9-pin (25-pin) female		
-	(2)	3		3	(2)	Tx
+	(3)	2		2	(3)	Rx
Com	(7)	5		5	(7)	Com

3.9.3 Comms Address

Typically the comms address is set to 1, but this can be changed. In the case of RS485 and multiple instruments it is necessary to set different addresses. To change the address value, access the level 2 list. In level 2 press the page key until the COMMS parameter is displayed. Press up ▲ down ▼ to select the address value.

3.9.4 Alarm Option

When an alarm board is fitted, which consists of a relay with voltage free contacts, for operator use, the contacts are taken to a panel plug on the control panel, wired as indicated:



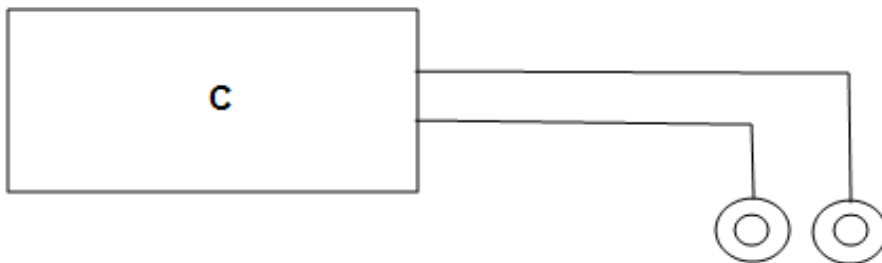
Key	
C	Temperature Controller
F	Fuse (2A)
S	Supply
L	Load
*	Normally open relay contacts
RO	Relay Output 240V 2A MAX

The purpose of the 2 amp fuse is to break the circuit to prevent overloading on the circuit due to high voltage.

The instrument configuration and parameters available to the operator depend on the customer requirements.




3.9.5 Remote Input and Output (Analogue Communications)

When analogue communications are fitted, the contacts are taken to insulated terminal sockets on the control panel.



Key	
C	Controller

Controller configuration depends on customer requirements.

Remote input (when specified) may be switched on and off using the remote setpoint enable parameter in the controller level 2, if this was made available for a particular application. In level 2 press page  until 'REM SP Enable' is displayed, press up  or down  to select SP1 (the normal controller setpoint) or SP2 (the remote input setpoint), 'SPX' will appear in the top left corner of the display.

Remote output does not require switching on and off.

3.9.6 Program segment output

When the customer requirement is for program segment output, an extra parameter is revealed in the PROG list. For each program segment, after the segment type and settings, the parameter EVENT OUTS appears. This has values on and off. If the value is

set to on, then the relay closes during the segment and a small 1 appears in the top left of the screen.

If more than one program segment output is fitted, then there are extra boxes depending on how many event outputs there are.

3.10 Temperature Controller Replacement



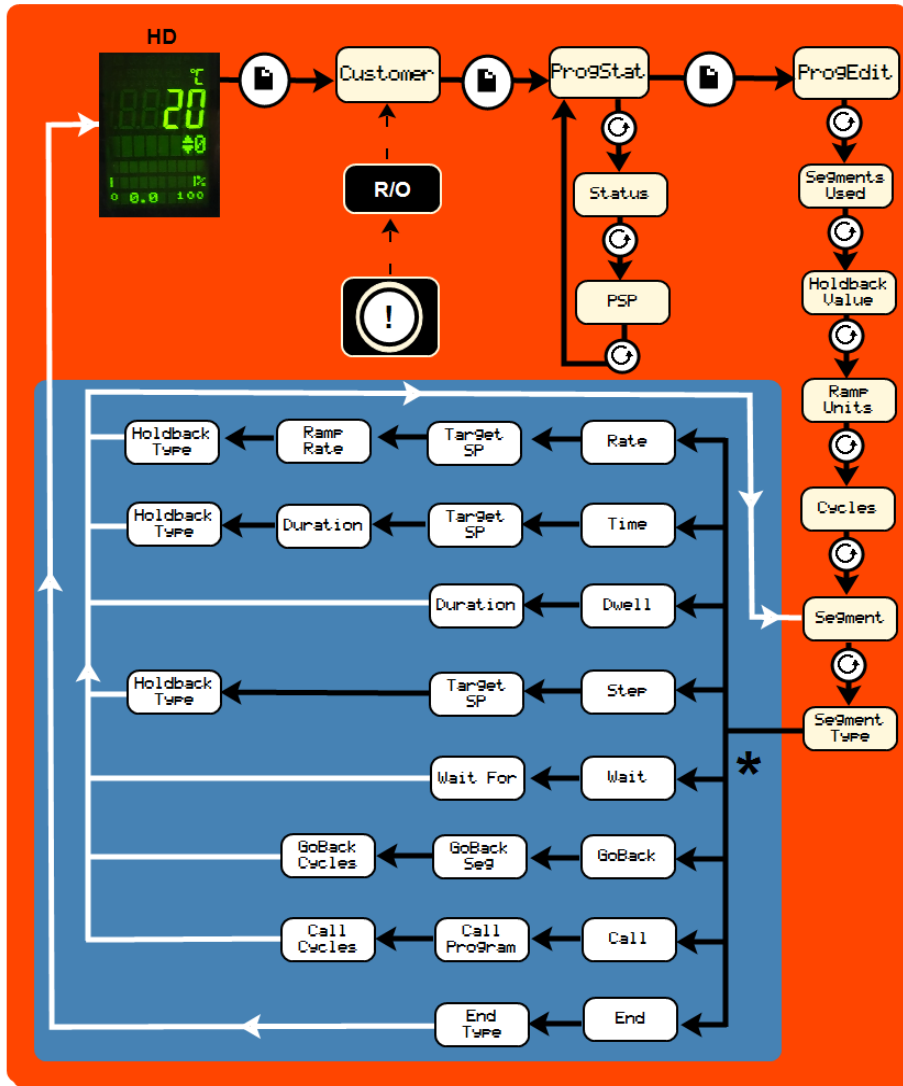
Before handling the controller: wear an anti-static wrist strap or otherwise avoid any possibility of damage to the unit by static electricity. Refer to the detailed instructions supplied with the replacement controller.

Ease apart the two lugs at the side; grip the instrument and withdraw it from its sleeve; push in the replacement.

3.11 Controller Navigation Diagrams

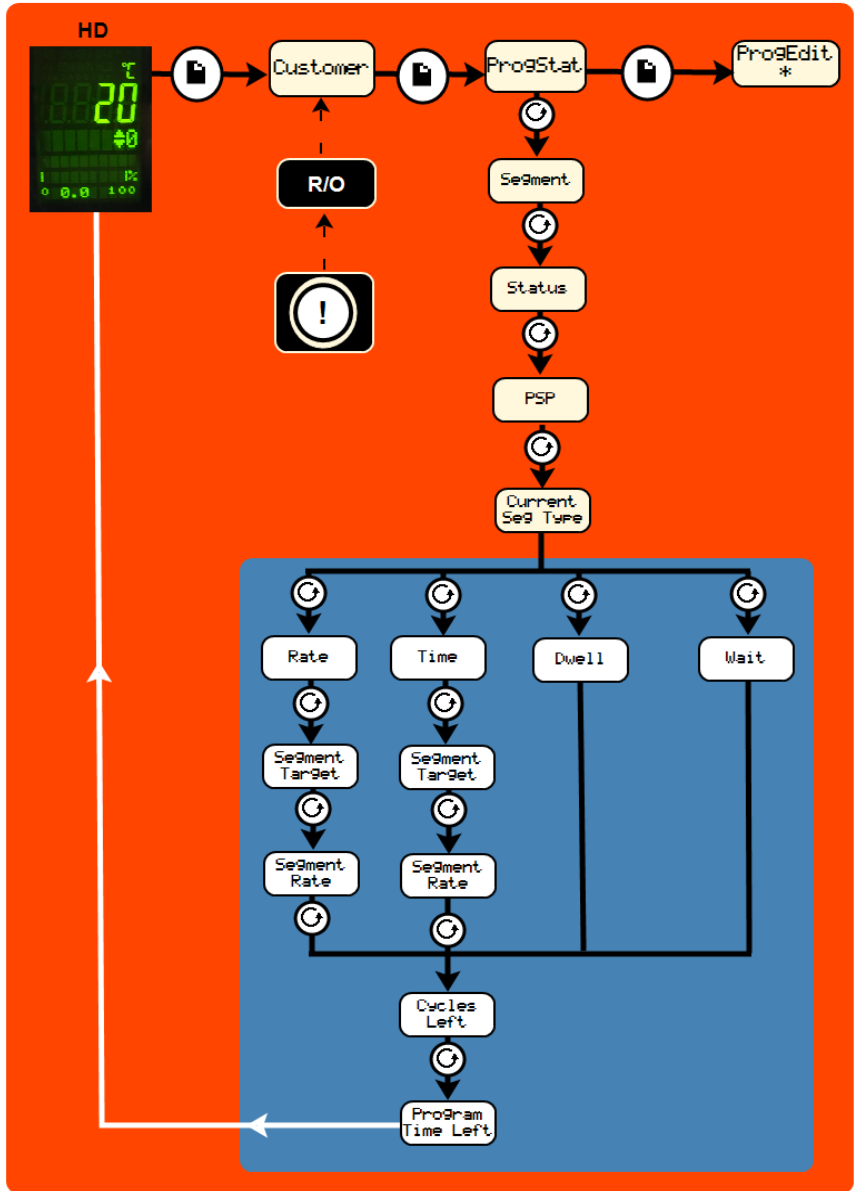
The following diagrams detail how to navigate to the various menu options within the 3508 Controller. At each option, values can be set using the arrow keys.

3.11.1 Operator Level 1 - No Program Running



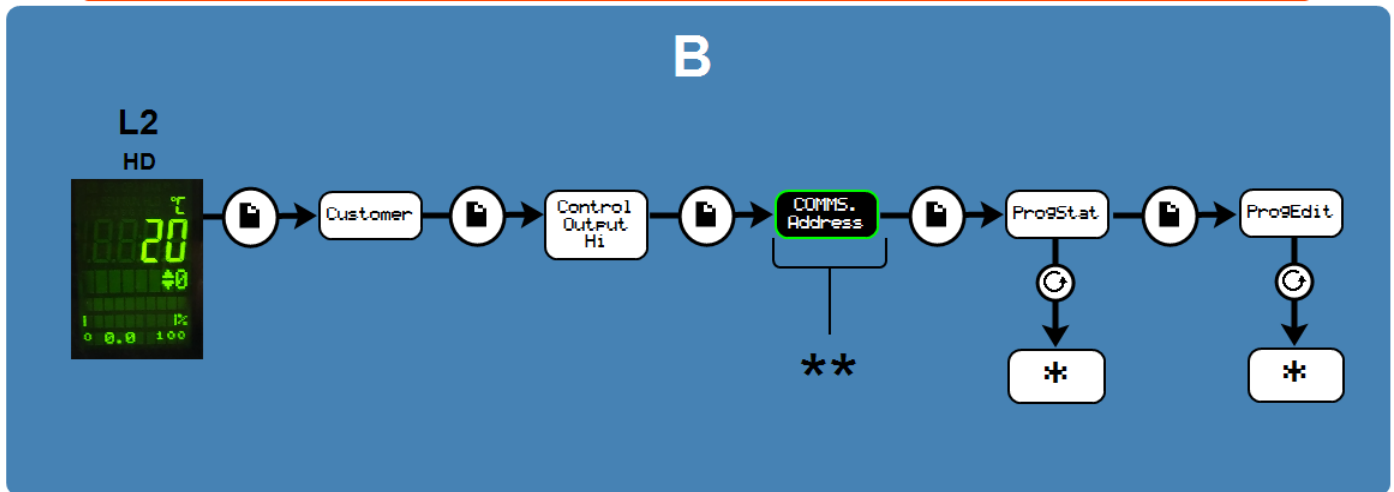
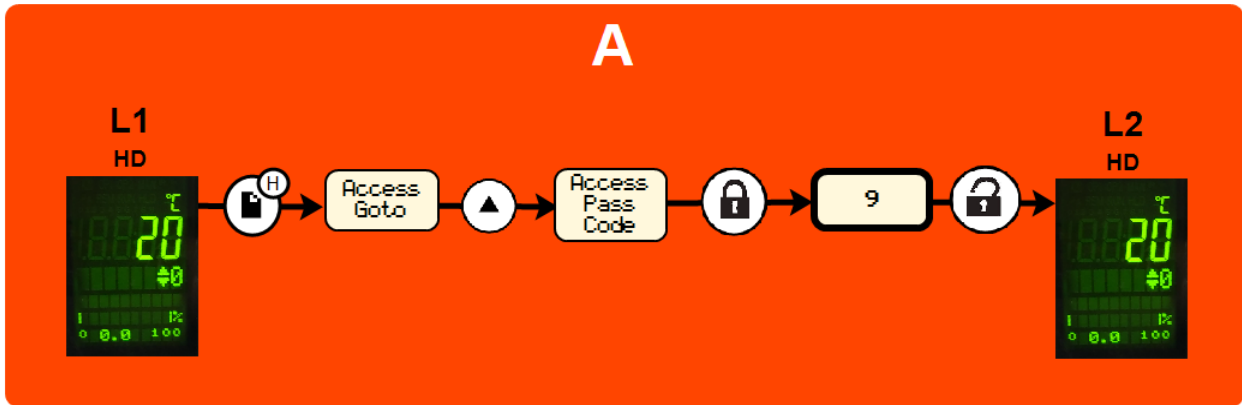
HD	Home Display		Controller identity when using more than one controller
R/O	Read Only		Black = Progress
	Page Key		White = Return
	Scroll Key	*	Visible Parameters depend on the Segment Type

3.11.2 Operator Level 1 - Program Running



HD	Home Display	!	Controller identity when using more than one controller
R/O	Read Only	→	Black = Progress
📄	Page Key	→	White = Return
🔄	Scroll Key	*	See previous diagram: Operator Level 1- No Program Running

3.11.3 Supervisor Level 2



A	To enter Level 2		Scroll Key
B	Level 2		Locked before Pass Code entered
L1	Level 1 Home Display		Unlocked
L2	Level 2 Home Display		Black = Progress
	Page Key		See previous diagram: Operator Level 1- No Program Running
	Hold Page Key for 3 seconds		If configured
	Arrow Key		

4.0 3508 Dual Loop Cascade Control (if fitted)

4.1 Principle of Cascade Control

When cascade control is fitted, the Load Loop 3508 senses the temperature of the workload, and the Element Loop 3508 senses the element temperature. Depending on the oven or furnace model, the Load Thermocouple may be in a fixed position, or may be movable. The Element Thermocouple is fixed in a predetermined position near the heating elements. The Load Thermocouple should be placed as near as possible to the work to be heated.

The Load Loop communicates with the Element Loop, calling for heat according to the load temperature and the current program or set point. The Element Loop regulates the heat according to element temperature and the requests from the Load Loop.

The element temperature could, in principle, vary between the furnace or oven maximum and minimum, regardless of the working temperature of the load. In practice, the cascade control system is configured to limit the element temperature to a band around the load temperature, typically of $\pm 10\%$ of the set-point temperature.

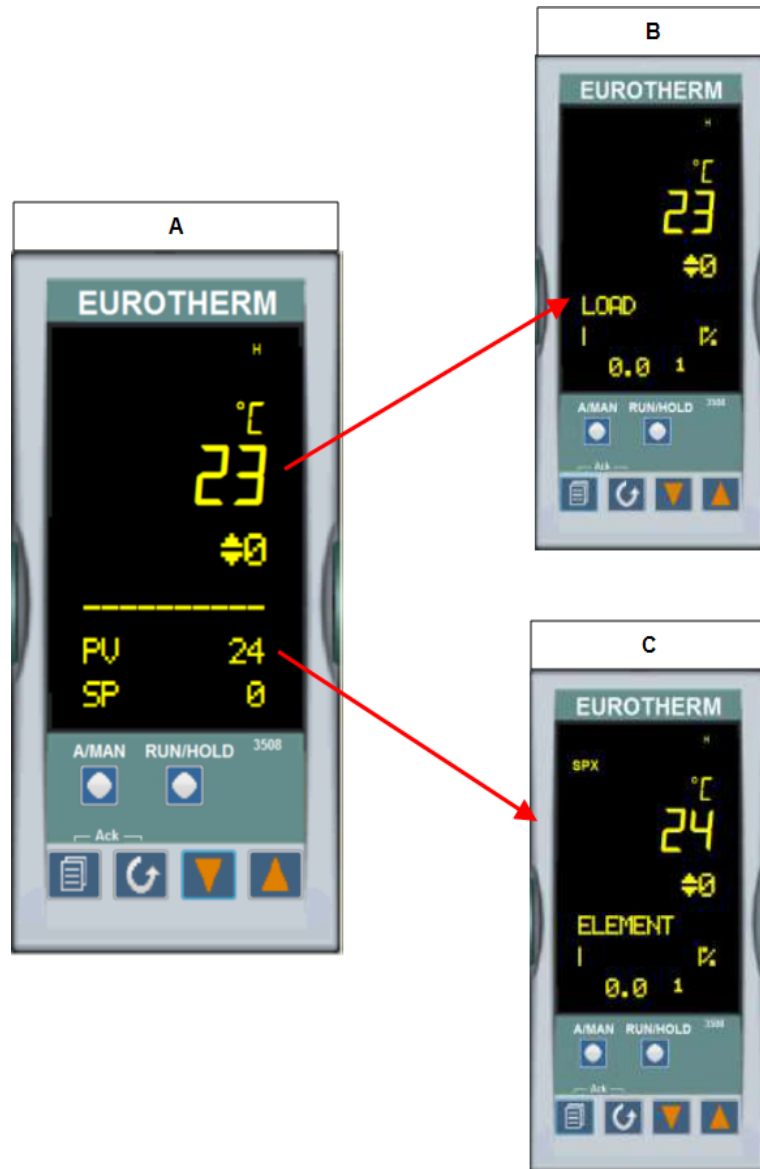
The set point of the load loop, shown at the top of the display, can be adjusted by the operator. The Element Loop, shown at the bottom of the display, should not be adjusted by the operator & will automatically regulate the element temperature to achieve the Load set temperature.

In a three-zone furnace for which the "three zone cascade" option has been ordered the centre zone is a 3508 Dual Loop & separate end zone controls are fitted. The operator sets the Load loop set point on the 3508 centre zone. The end zone controllers work automatically & need no adjustment by the operator.

4.2 Operation of Cascade Control

The operator may ignore all the complications of the system, and program the Load Loop according to the standard instructions for that controller. The home display shows the load loop at the top of the display and the Element loop at the bottom. By pressing the page key, separate views of load and element loops will be shown.

Key	
A	Home Display View
B	Load Loop View
C	Element Loop View



The Element Loop should never be adjusted. Note that the elements usually run at a higher temperature than the load.

Because the details of the customer's cascade application (in particular the nature of the load) are generally not known, the feed forward parameter (FF Trim) is made easily accessible in level 2 (Refer to instrument operating instructions). Its default setting is 2%. If overshoot of the load temperature occurs – often a problem at low temperatures – then FF Trim can be reduced in order to limit the amount of overshoot. However, if FF trim is reduced too much, the load may not reach the desired temperature. If the load does not reach the desired temperature or is slow in the final stages, FF Trim can be increased: a maximum of 10% is suggested.



Feed Forward View

When attempting to control at very low temperatures it can become a problem to achieve stable control because of excessive power being supplied during heating. The available power can be limited using the power limit parameter OP.Hi, make a note of the original settings before adjusting. For power settings please refer to the fuse and power section at the back of the manual. If the parameter is normally set to 100%, try initially setting it to 50% to improve stability. Avoid settings below 40% where possible (though some furnaces require low settings for reasons unconnected with cascade control).



Power Limit View

4.3 Bypassing Cascade Control

This applies where the Control Thermocouple is a removal probe (e.g. in a tube furnace), or where for other reasons it may be required to operate the furnace or oven directly from the Element Loop.

To operate without Cascade Control the load thermocouple has to remain connected at all time; or a link has to be made across the thermocouple input connections.

4.4 3508P1 Element Loop (Loop 2)

In these circumstances the Element Controller is configured with the local/remote parameter, accessible in level 2 (Refer to instrument operating instructions).

To switch cascade control on or off. In Level 2, press Scroll until the display shows L-r.

Using the up ▲ down ▼ set:

- *SP2* = cascade control on
- *SP1* = cascade control off

The top left hand side of the screen will show *SPX* when *SP2* is enabled. The instrument operates as an independent Programmer/Controller when L-r is set to *SP1*. To return to cascade control, change the L-r parameter to *SP2*. Also note that cooling at low temperatures takes longer per degree than it does at high temperatures.

4.5 Caution



If the Load Thermocouple is removable, leave it in the furnace or oven chamber whenever possible. Operating with the Cascade Control active and with the Load Thermocouple in an unheated position (such as lying on the work bench) may cause the furnace or oven to heat up to its maximum temperature, wasting power and possibly shortening element life.

4.6 Over-Temperature Control

Where over-temperature control is fitted, it normally protects against failure of the control system or of a component such as a power control relay. The over-temperature controller must be set at a level higher than the greatest element temperature, typically 15 °C above maximum.

If the working temperature is less than the maximum temperature, then it may be possible to set the over-temperature limit as follows:

$$\text{working temperature} + (\text{maximum temperature} \times \text{FF}/100) + 15 \text{ } ^\circ\text{C}$$

where FF is the Feed Forward percent parameter value (e.g. 10)

Example: for working at 800 °C in a 1200 °C product, the over-temperature limit could be set to $800+120+15=935$.

5.0 2132 Over-Temperature Controller Description (if fitted)

5.1 Description



This over-temperature controller is fitted and supplied ready to use by Carbolite Gero. It is a digital instrument with a latching alarm, requiring no additional panel controls. The controller features easy setting of over-temperature setpoint and reading of current temperature by the over-temperature sensor.

5.2 Operation

5.2.1 Controls

Most Carbolite Gero products are fitted with an instrument switch which cuts off power to the controller and other parts of the control circuit.

To operate the controller, power must be supplied to the product and the instrument switch must be on. If a time switch is included in the product circuit, this must be in the 'ON' position.


When an over-temperature condition occurs, the controller cuts the power to a contactor, which in turn cuts power to the heating elements. Power is not restored until the controller is 'reset'.


Some components will operate after the over-temperature feature isolates the power supply e.g. cooling fans will continue to operate, provided that there is a power supply to the product. In some cases the product may not do so, if other options (such as a door switch) are fitted.


5.2.2 Operation

When switched on, the controller lights up, goes through a short test routine and then displays the measured temperature or the over-temperature setpoint.

The page key  allows access to parameter lists within the controller.

A single press of the page key  displays the temperature units, normally set to °C; further presses reveal the lists indicated in the navigation diagram. See section 5.4.



The scroll key  allows access to the parameters within a list. Some parameters are display-only; others may be altered by the operator.


A single press of the scroll key  in the 'Home' list displays the temperature units; further presses reveal the parameters in the current list indicated in the navigation diagram.

To return to the 'Home' list at any time, press page  and scroll  together, or wait for 45 seconds.

The down  and up  keys are used to alter the setpoint or other parameter values.

5.2.3 Over-Temperature Operation

Use down  and up  to alter the over-temperature setpoint. This should normally be set a little above the working temperature (for example 15 °C above). The product is supplied with the over-temperature set at 15 °C above the furnace or oven maximum working temperature.

Press scroll  twice view the present temperature as measured by the over-temperature controller. Press it twice, the first press shows the temperature units (°C).

5.2.4 Over-Temperature Alarm

If an over-temperature condition occurs, the OP2 indicator flashes and an alarm message 2FSH also flashes, alternating with the setpoint. Power to the heating elements is disconnected.

5.2.5 Resetting the Over-Temperature Alarm

To acknowledge the alarm press scroll  and page  together.

If the alarm is acknowledged while there is still an over-temperature condition, the OP2 indicator stops flashing but continues to glow. The 2FSH alarm continues to flash until the over-temperature condition is cleared (by the temperature falling), when normal operation resumes.

If the alarm is acknowledged when the temperature has dropped (or after the over-temperature setpoint has been raised) so that the over-temperature condition no longer exists, then the furnace or oven immediately resumes normal operation.

5.2.6 Sensor Break

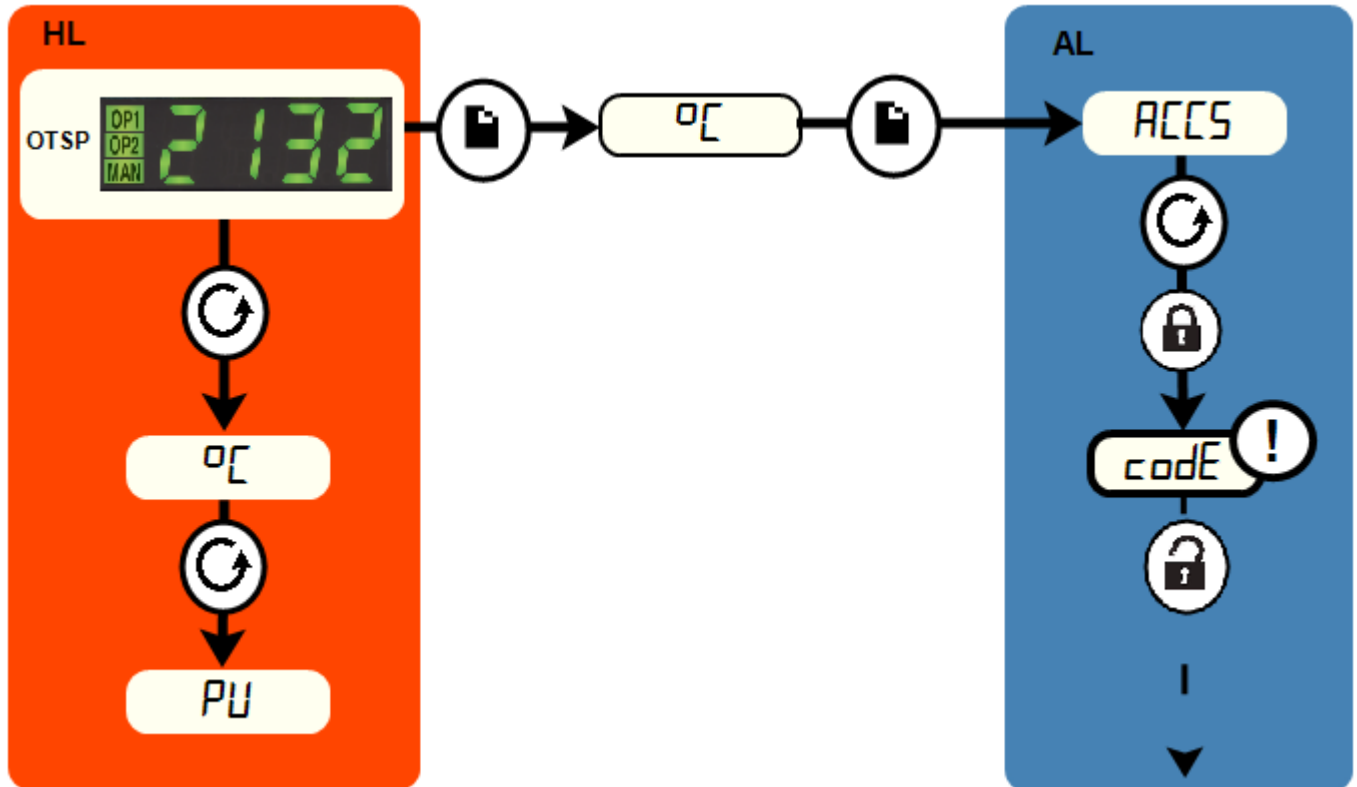
The over-temperature cut-out system also operates if the over-temperature control thermocouple breaks or becomes disconnected. The message S.br flashes where the measured temperature is normally displayed.

5.3 Audible Alarm

If an audible alarm is supplied for use with the over-temperature controller, it is normally configured to sound on over-temperature condition and to stop sounding when the alarm is acknowledged as given in section 5.2.

Note: the alarm may sound during controller start-up.

5.4 Navigation Diagram



HL	Home List		Page Key	➔	Black = Progress
OTSP	Over-Temperature Setpoint		Scroll Key		Dashed = Through to other options
AL	Access List		For factory access to list and parameters not available to the operator.		

6.0 Operation

6.1 Operating Cycle

This product is fitted with an instrument switch which cuts off power to the control circuit.

Connect the product to the electrical supply.

Turn on the instrument switch to activate the temperature controllers. The controllers illuminate and go through a short test cycle.

Over-Temperature option only. If the digital over-temperature option has not yet been set as required, set and activate it according to the over-temperature controller instructions.

Switch on the heater switch, located on the instrument panel. Unless a time switch is fitted and is switched off, the product will start to heat up. The Heat light(s) glow steadily at first and then flash as the product approaches the desired temperature or a program setpoint.

Over-Temperature option only. If the over-temperature circuit has tripped, an indicator on the over-temperature controller flashes and the heating elements are isolated. Find and correct the cause before resetting the over-temperature controller according to the instructions supplied.

To switch off power to the heating elements, use the heater switch. To switch the product off, use both the heater switch and the instrument switch. If the product is to be left switched off and unattended, isolate it from the electrical supply.

6.2 General Operating Advice



Heating element life is shortened by overheating. Do not leave the product at high temperature when it is not required. The maximum temperature is shown on the product rating label and in section 12.0 towards the back of this manual.



Lightweight ceramic fibre insulation can easily be marked by accidental contact. Some fine cracks may develop in the surface of the insulation due to the progressive shrinkage of the insulation materials. Cracks are not usually detrimental to the functioning or the safety of the product.

Clean up any spillages in the insulation, as these can increase the rate of degradation of the insulation material.

6.3 Operator Safety



The ceramic materials used in the product manufacture become electrically conductive to some extent at high temperatures. DO NOT use any conductive tools within the product without isolating it. If a metal work tube is used, it must be earthed (grounded).

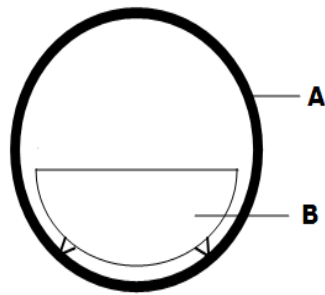


Switch off the heater switch whenever loading or unloading the product. The elements are isolated when the heater switch is OFF. This switch cuts both sides of the circuit via a contactor.

6.4 Tube Life

A ceramic work tube may crack if work pieces are inserted too quickly or at temperatures below 900 °C (when the tube is more brittle). Large work pieces should also be heated slowly to ensure that large temperature differences do not arise.

Poor thermal contact should be encouraged between the work piece and the tube; crucibles or boats should be of low thermal mass and should have feet to reduce the contact with the tube (fig. 4).



Key	
A	Tube
B	Crucible

Fig 4 - Avoidance of thermal contact

Do not set too high a heating or cooling rate. As tubes are susceptible to thermal shock and may break. Tubes which extend beyond the heated part of the furnace are more at risk. A general rule for maximum heating or cooling rate is $400 \div$ internal diameter in mm to give (°C/ min); for 75 mm i/ d tubes this comes to 5 °C per minute. The controller can be set to limit both the heating and cooling rate.

6.5 Pressure

Work tubes are not able to accept high internal pressure. When gas seals or similar fittings are in use, the gas pressure should be restricted to a maximum of 0.2 bar (3 psi). A pressure of approximately half of that should normally be sufficient to achieve the desired flow rate. The operator must ensure that the exhaust path from the tube is not blocked, so that excess pressure does not occur.

A suitably regulated gas supply should always be used.

It is recommended that a pressure relief system should be used to avoid an over pressurisation of the work tube.

Please note: A product should not be heated up if any valves that have been fitted are closed to create a sealed volume. A sealed work tube should not be heated from cold due to the pressure increase caused by the trapped air or gas expanding during the heating process.

6.6 Gas Tightness

Work tubes of IAP material are impervious. Sillimanite may look similar but is porous. Ensure that the correct tube material is in use before connecting and using gases other than inert gases, such as nitrogen.

6.7 Running at Low Temperatures

The power limit may be adjusted to a low level in order to achieve better control when operating the product at a low temperature. Before changing the power limit, record the default settings for possible future use. Refer to the Power Settings section of this manual for default power limits. If the product fails to reach the desired temperature, refer to the Temperature Controller and Fault Analysis sections.

7.0 Maintenance

7.1 General Maintenance

Preventive rather than reactive maintenance is recommended. The type and frequency depends on the product use; the following are recommended.












7.2 Maintenance Schedule


 CUSTOMER

 QUALIFIED PERSONNEL



DANGER! ELECTRIC SHOCK. Risk of fatal injury. Only electrically qualified personnel should attempt these maintenance procedures.

Maintenance Procedure	Method	Frequency				
		Daily	Weekly	Monthly	Bi-Annually	Annually
Safety						
Over-Temperature Safety Circuit (if fitted)	Set an over-temperature setpoint lower than the displayed temperature and check for an over-temperature alarm as detailed in this manual					
Over-Temperature Safety Circuit (if fitted)	Electrical measurement 					
Safety Switch Function (split models only)	Set a safe temperature above ambient, and open the furnace to see if the heater light goes out					
Safety Switch Function (split models only)	Electrical measurement 					
Electrical Safety (external)	Visual check of external cables and plugs					
Electrical Safety (internal)	Physically check all connections and cleaning of the power plate area					
Function						
Temperature Calibration	Tested using certified equipment, frequency dependent on the standard required					
Operational Check	Check that all functions are working normally					
Operational Check	Thorough inspection and report incorporating a test of all functions					
Work Tube Position	Visually check that the tube is central to the heated zone (horizontally / vertically)					
End Plugs / Radiation Shields	Visual check for damage or wear, and cor-					

	rect positioning					
Seals (if fitted)	Check all seals and O-rings and clamps					
Performance						
Element Circuit	Electrical measurement 					6
Power Consumption	Measure the current drawn on each phase / circuit					6
Cooling Fans (if fitted)	Check whether the cooling fans are working					

7.2.1 Cleaning

Soot deposits may form inside the furnace, depending on the process. At appropriate intervals remove these by heating as indicated in the General Operation Notes.



The product's outer surface may be cleaned with a damp cloth. Do not allow water to enter the interior of the case or chamber. Do not clean with organic solvents.

7.3 Calibration

After prolonged use, the controller and/or thermocouple may require recalibration. This is important for processes that require accurate temperature readings or for those that use the product close to its maximum temperature. A quick check using an independent thermocouple and temperature indicator should be made from time to time to determine whether full calibration is required. Carbolite Gero can supply these items.

Depending on the controller fitted, the controller instructions may contain calibration instructions.

7.4 After-Sales Service

Carbolite Gero Service has a team of Service Engineers who can offer repair, calibration and preventive maintenance of furnace and oven products both at the Carbolite Gero factory and at customers' premises throughout the world. A telephone call or email often enables a fault to be diagnosed and the necessary parts to be despatched.

In all correspondence please quote the serial number and model type given on the rating label of the product. The serial number and model type are also given on the back of this manual when supplied with the product.

Carbolite Gero Service and Carbolite Gero contact information can be found on the back page of this manual.

7.5 Recommended Spare Parts and Spare Parts Kit

Carbolite Gero can supply individual spare parts or a kit of the items most likely to be required. Ordering a kit in advance can save time in the event of a breakdown.

Each kit consists of one thermocouple, one solid state relay and a heating element of each wattage (normally 2 elements, but 1 in the case of model -/300).

When ordering spare parts please quote the model details: model type and serial number.

8.0 Repairs and Replacements

8.1 Safety Warning - Disconnection from Power Supply



Immediately switch the product off in the event of unforeseen circumstances (e.g. large amount of smoke). Allow the product to return to room temperature before inspection.



Always ensure that the product is disconnected from the electrical supply before repair work is carried out.

Caution: Double pole/neutral fusing may be used in this product.

8.2 Safety Warning - Refractory Fibre Insulation



Insulation made from High Temperature Insulation Wool Refractory Ceramic Fibre, better known as (Alumina silicate wool - ASW).

This product contains **alumino silicate wool** products in its thermal insulation. These materials may be in the form of blanket or felt, formed board or shapes, slab or loose fill wool.

Typical use does not result in any significant level of airborne dust from these materials, but much higher levels may be encountered during maintenance or repair.

Whilst there is no evidence of any long term health hazards, it is strongly recommended that safety precautions are taken whenever the materials are handled.

Exposure to fibre dust may cause respiratory disease.

When handling the material, always use approved respiratory protection equipment (RPE-eg. FFP3), eye protection, gloves and long sleeved clothing.

Avoid breaking up waste material. Dispose of waste in sealed containers.

After handling, rinse exposed skin with water before washing gently with soap (not detergent). Wash work clothing separately.

Before commencing any major repairs it is recommended to make reference to the European Association representing the High Temperature Insulation Wool industry (www.ecfia.eu).

Further information can be provided on request. Alternatively, Carbolite Gero Service can quote for any repairs to be carried out either on site or at the Carbolite Gero factory.

8.3 Temperature Controller Replacement

Refer to the controller instructions for more information on how to replace the temperature controller.

8.4 Solid-state Relay Replacement



Disconnect the product from the power supply and remove the appropriate cover as given above.

Make a note of the wire connections to the solid state relay and disconnect them.

Remove the solid state relay from the base panel or aluminium plate.

Replace and reconnect the solid state relay ensuring that the bottom of it has good thermal contact with the base panel or aluminium plate.

Replace the access panel.

8.5 Thermocouple Replacement

For vertical models it may be necessary to dismount the furnace from its stand and remove the terminal cover.



Disconnect the product from the power supply. Remove terminal cover to gain access to the thermocouple connections. Make a note of the thermocouple connections.

Thermocouple cable colour codings are:

thermocouple leg	colour
positive (type N)	pink
negative	white

Disconnect the thermocouple from its terminal block.

Carefully withdraw the thermocouple from the product and remove any broken bits of thermocouple.

Bend the new thermocouple carefully to match the shape of the original (working from the terminal end). Should the length differ from that of the original this is usually not important provided that the thermocouple tip is within a work tube diameter's distance from the furnace centre.

Insert the new thermocouple into position, restoring any removed porcelain spacers and ensuring correct polarity.

Re-assemble the furnace.

8.6 Element Replacement



See section 8.2 - wearing a face mask is required.

Disconnect the product from the electrical supply.

Remove all outer guards, meshes and terminal covers from the product body. For a horizontally mounted product remove the product body from its base; to reach the bolts or screws that fix the body to the base, remove the back panel from the base.

Disconnect all electrical leads from the terminal blocks on the product case. Note the colours and positions of the connecting leads to enable correct reassembly. Take care not to crack porcelain terminal blocks - use two spanners where appropriate.

Remove the thermocouple(s).

Lay the product body horizontally with the split in the cylindrical case uppermost. Remove the two metal end-caps from the body. Undo the self-tapping screws that hold the terminal strip to the case join. The case will spring open slightly. Remove the ceramic board disc from one end.

Cut through the outer wrap of blanket insulation. Note how the element tails are connected and disconnect all of them. Lift out the elements through the end of the cylindrical case.

Check the cylindrical case and clean out as appropriate.

Remove any insulation sleeving from the tails of the old element and fit to the replacement element.

Slide in the new element(s). Close up the product again, refitting the terminal strip and the end-caps. Any cut made in the insulation should close up completely: if the insulation appears loose or damaged in any way, please contact the Carbolite Gero Service.

Reverse the rest of the dis-assembly process. Take care to make all connections to the correct terminals. Do not over-tighten the connectors in the porcelain terminal blocks.

Let the product heat up at its maximum rate to 900 °C without interruption and then dwell for 1 hour. Fumes may be emitted: this should be done in an environment with good ventilation.

Note on Elements: The end and centre elements look the same but have different wattages. On standard models the two end elements are 1170 W and all the centre elements are 780 W. Ensure that elements are correctly replaced.

Check that the product is controlling properly to rule out the possibility that the element failed because of a fault in the control system.

If you have any problems with this procedure, please contact the Carbolite Gero Service.

8.7 Fuse Replacement

Fuses are marked on the wiring diagram with type codes, e.g. F1, F2. For more information on fuses refer to section 11.0.

Depending on model and voltage, the different fuse types may or may not be fitted.

If any fuse has failed, it is advisable for an electrician to check the internal circuits.

Replace any failed fuses with the correct type. For safety reasons do not fit larger capacity fuses without first consulting Carbolite Gero.

The fuses are located at the cable entry point. Remove the back panel or control box back panel to gain access to the fuses.

9.0 Fault Analysis

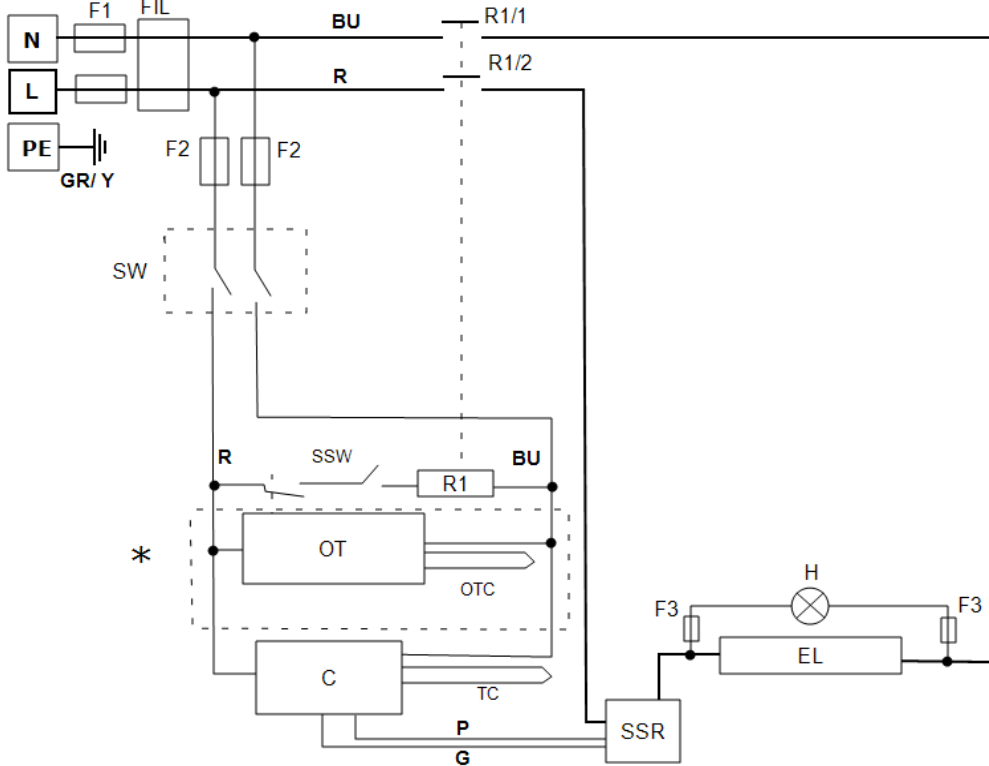
A. Furnace Does Not Heat Up				
1.	The HEAT light is ON	▶	The heating element has failed	▶ Check also that the SSR is working correctly
2.	The HEAT light is OFF	▶	The controller shows a very high temperature or code such as S.br	▶ The thermocouple has broken or has a wiring fault
		▶	The controller shows a low temperature	▶ The door switch(es) (if fitted) may be faulty or need adjustment
				▶ The contactor/relay (if fitted) may be faulty
				▶ The heater switch (if fitted) may be faulty or need adjustment
				▶ The SSR could be failing to switch on due to internal failure, faulty logic wiring from the controller, or faulty controller
		▶	There are no lights glowing on the controller	▶ Check the supply fuses and any fuses in the furnace control compartment
				▶ The controller may be faulty or not receiving a supply due to a faulty switch or a wiring fault.

B. Product Overheats					
1.	Product only heats up when the instrument switch is ON	▶	The controller shows a very high temperature	▶	The controller is faulty
		▶	The controller shows a low temperature	▶	The thermocouple may be faulty or may have been removed out of the heating chamber
				▶	The thermocouple may be connected the wrong way around
				▶	The controller may be faulty
2.	Product heats up when the instrument switch is OFF	▶	The SSR has failed "ON"	▶	Check for an accidental wiring fault that could have overloaded the SSR

10.0 Wiring Diagrams

10.1 WA-11-31

Connections below show single phase with safety switches and over-temperature control.

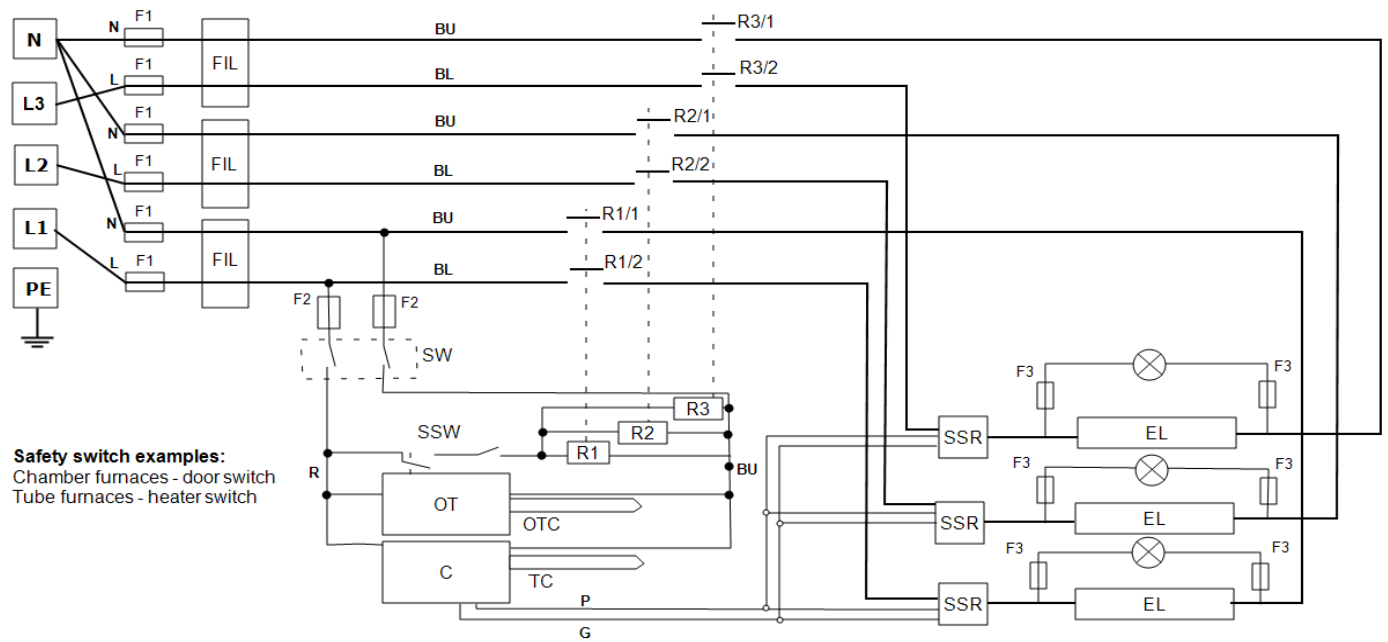


Key	
F1, F2, F3	Fuses
FIL	Filter
R1/1, R1/2	Relay Contactor
R1	Relay
C	Temperature Controller
OT	Over-Temperature Controller
OTC	Over-Temperature Thermocouple
TC	Control Thermocouple
SSR	Solid State Relay
SSW	Safety Switch
H	Heat Lamp
EL	Element(s)
SW	Instrument Switch(es)
N	Neutral
L	Live
PE	Earth
*	If Fitted

Cables	
BU	Blue
R	Red
GR/Y	Green + Yellow
G	Grey
P	Pink

10.2 WA-U3-31

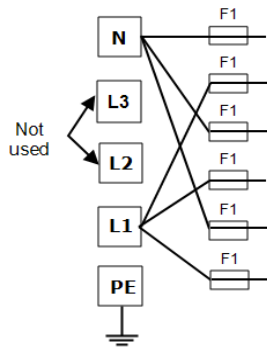
Connections below show 3-phase +N with safety switches and over-temperature control.



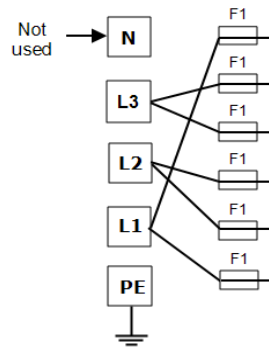
Safety switch examples:
Chamber furnaces - door switch
Tube furnaces - heater switch

See below for other configurations

Single Phase Connections



Delta Connections



Key	
F1, F2, F3	Fuses
FIL	Filter (if fitted)
C	Controller
TC	Control Thermocouple
OT	Over-Temperature Controller
OTC	Over-Temperature Thermocouple
R1, R2, R3	Relay
R1/1, R1/2, R2/1, R2/2, R3/1, R3/2	Relay contactor
SW	Instrument Switch(es)
SSW	Safety Switch
EL	Element
SSR	Solid State Relay
N	Neutral
L1, L2, L3	Live
PE	Earth

Cables	
BU	Blue
R	Red
BL	Black
GR/Y	Green + Yellow
G	Grey
P	Pink

Products with this wiring arrangement may be converted between the following supply voltages (please refer to the table within section 11.0 for compatible phases with the product):

- 3-phase + neutral in the range 380/220 V - 415/240 V
- 3-phase delta in the range 220 V - 240 V
- Single phase in the range 220 V - 240 V
- *208 V model: can be converted between 208 V delta and 208 V 1-phase*

Please contact Carbolite Gero Service for details.

11.0 Fuses and Power Settings

11.1 Fuses

F1 - F2: Refer to the circuit diagrams.

F1	Internal Supply Fuses	Fitted if supply cable fitted. Fitted on board to some types of EMC filter.	GEC Safeclip of the type shown (glass type F up to 16 A) 38 mm x 10 mm type F fitted on EMC filter circuit board(s)
----	-----------------------	--	--

F2	Auxiliary Circuit Fuses	Fitted on board to some types of EMC filter. May be omitted up to 25 Amp/phase supply rating.	2 Amps glass type F On board: 20 mm x 5 mm Other: 32 mm x 6 mm
----	-------------------------	--	--

	Customer Fuses	Required if no supply cable fitted. Recommended if cable fitted.	See rating label for current; See table below for fuse rating.
--	----------------	---	---

Model	Phases	Volts	Supply Fuse Rating (Amps) F1
GHA 12/1200	1-phase	200-208	12 A
GHA 12/1200	1-phase	220-240	12 A
GHA 12/1200	3-phase +N	380-415	12 A

11.2 Power Settings

The power limit settings (OP.Hi) for this model is as follows. The figures represent the maximum percentage of time that controlled power is supplied to the elements. Do not attempt to "improve performance" by setting a value higher than the one from the table. To adjust the parameter refer to the "Changing the Maximum Output Power" of the control section of the manual.

All standard models covered by this manual are fitted with elements designed for use over the range of voltages 200 V-240 V; the power limit parameter is set according to the table below.

200 V	208 V	220 V	230 V	240 V	380 V	400 V	415 V	440 V	480 V
100	100	89	82	75	90	97	75	67	56

Please refer to the rating label for product specific information.

12.0 Specifications

Carbolite Gero reserves the right to change the specification without notice.

All models have cylindrical elements with wire formed in the surface of the insulation material.

All models can accept work tubes up to a maximum outside diameter of 170 mm.

All models have a maximum operating temperature of 1200 °C (1100°C continuous).

Model	Max Temp (°C)	Max Power (kW)	Minimum Work Tube Length (mm)	Heated Length (mm)	Type C Work Tube	Type D Work Tube
Horizontal single-zone tube furnaces.						
GHA 12/1200	1200	7.0	1400	1200	1500	1800

12.1 Environment

The models listed in this manual contains electrical parts and should be stored and used in indoor conditions as follows:

Temperature: 5 °C - 40 °C

Relative humidity: Maximum 80 % up to 31 °C decreasing linearly to 50 % at 40 °C

Service Record

Engineer Name	Date	Record of Work

ProductLabel

The products covered in this manual are only a small part of the wide range of ovens, chamber furnaces and tube furnaces manufactured by Carbolite Gero for laboratory and industrial use. For further details of our standard or custom built products please contact us at the address below, or ask your nearest stockist.

For preventive maintenance, repair and calibration of all furnace and oven products, please contact:

Carbolite Gero Service

Telephone: + 44 (0) 1433 624242

Fax: +44 (0) 1433 624243

Email: ServiceUK@carbolite-gero.com

Carbolite Gero Ltd,

Parsons Lane, Hope, Hope Valley,
S33 6RB, England.

Telephone: + 44 (0) 1433 620011

Fax: + 44 (0) 1433 621198

Email: Info@carbolite-gero.com

www.carbolite-gero.com

CARBOLITE
GERO 30-3000°C

Copyright © 2018 Carbolite Gero Limited