

Tyreflex Couplings



RENOLD
Superior Coupling Technology

www.renold.com

RENOLD

Strength through Service

Renold Gears has been manufacturing high quality, high specification gear units for over 100 years and has always been at the leading edge of gear technology with innovative products and power transmission solutions.

Interchangeability

Many of the products from Renold Gears are dimensionally interchangeable with other manufacturers gear units, allowing a trouble free replacement of gearboxes, in most cases upgrading the capacity through state of the art technology and materials.

Custom Made

Renold Gears is unique in it's ability to offer custom made products designed to meet customers exacting requirements without compromise on availability and cost. From complete package solutions to individual precision replacement gears, all can be tailor made to meet specific applicational requirements.

Available

The most popular ranges of gearboxes are available from local distribution stock, backed up by extensive stocks from our manufacturing plant in the UK.

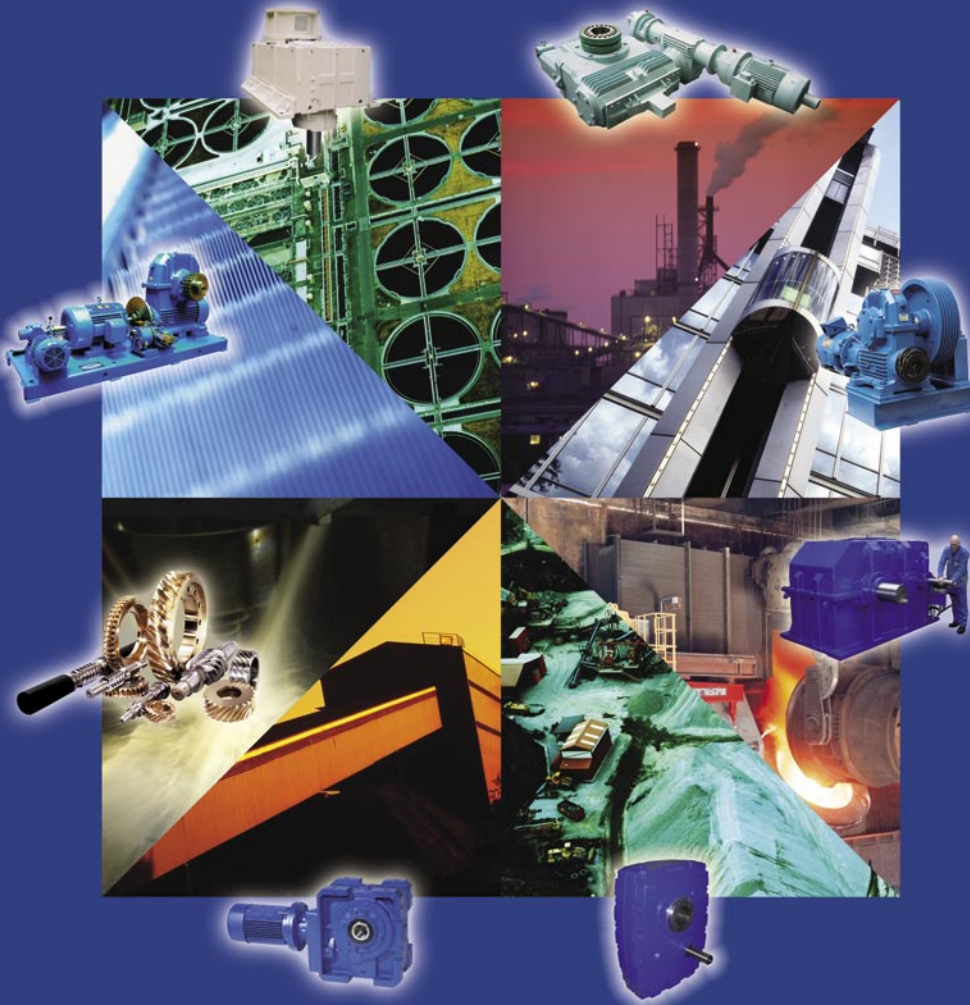

RENOLD

Superior Gear Technology

www.renold.com

Contents

	<i>Page No</i>
Renold Gears	inside front cover
The Renold Collection	02
Coupling Selection Guide	04
Load Classification by Application	05
Service Factors and Selection	06
Key and Keyway Dimensions	07
Tyreflex	08
Renold Chain	inside back cover

The **RENOLD** Collection

Spiderflex Coupling



Max power / 100 rpm (kW)	33 kW
Max weight	63 kg
Max shaft size	115 mm
Max speed (rpm)	7,700 rpm
Max outer diameter	275 mm
Max torque (Nm)	3,150 Nm

www.renold.com **RENOLD**
Superior Coupling Technology

SpiderJaw Coupling



Max power / 100 rpm (kW)	45 kW
Max weight	84 kg
Max shaft size	115 mm
Max speed (rpm)	31,000 rpm
Max outer diameter	305 mm
Max torque (Nm)	4,308 Nm

www.renold.com **RENOLD**
Superior Coupling Technology

SpiderWrap Coupling



Max power / 100 rpm (kW)	45 kW
Max weight	84 kg
Max shaft size	115 mm
Max speed (rpm)	9,000 rpm
Max outer diameter	323 mm
Max torque (Nm)	4,308 Nm

www.renold.com **RENOLD**
Superior Coupling Technology

Pinflex Coupling



Max power / 100 rpm (kW)	340 kW
Max weight	423 kg
Max shaft size	260 mm
Max speed (rpm)	6,800 rpm
Max outer diameter	490 mm
Max torque (Nm)	32,500 Nm

www.renold.com **RENOLD**
Superior Coupling Technology

Crownpin Coupling



Max power / 100 rpm (kW)	2,607 kW
Max weight	2,250 kg
Max shaft size	300 mm
Max speed (rpm)	6,210 rpm
Max outer diameter	1,220 mm
Max torque (Nm)	249,400 Nm

www.renold.com **RENOLD**
Superior Coupling Technology

Tyreflex Coupling



Max power / 100 rpm (kW)	66 kW
Max weight	49 kg
Max shaft size	150 mm
Max speed (rpm)	4,500 rpm
Max outer diameter	470 mm
Max torque (Nm)	6,270 Nm

www.renold.com **RENOLD**
Superior Coupling Technology

Discflex Coupling



Max power / 100 rpm (kW)	45 kW
Max weight	67 kg
Max shaft size	110 mm
Max speed (rpm)	2,900 rpm
Max outer diameter	324 mm
Max torque (Nm)	4,298 Nm

www.renold.com **RENOLD**
Superior Coupling Technology

Chainflex Coupling



Max power / 100 rpm (kW)	90 kW
Max weight	85 kg
Max shaft size	140 mm
Max speed (rpm)	3,500 rpm
Max outer diameter	357 mm
Max torque (Nm)	8,595 Nm

www.renold.com **RENOLD**
Superior Coupling Technology

The **RENOLD** Collection

Rigid Coupling



Max power / 100 rpm (kW)	1,640 kW
Max weight	501 kg
Max shaft size	290 mm
Max speed (rpm)	7,100 rpm
Max outer diameter	527 mm
Max torque (Nm)	156,620 Nm

www.renold.com **RENOLD**
Superior Coupling Technology

Renoldflex



Max power / 100 rpm (kW)	482 kW
Max weight	N/A
Max shaft size	180 mm
Max speed (rpm)	1,200 rpm
Max outer diameter	345 mm
Max torque (Nm)	46,000 Nm

www.renold.com **RENOLD**
Superior Coupling Technology

A Series Gear Coupling



Max power / 100 rpm (kW)	1,640 kW
Max weight	443 kg
Max shaft size	260 mm
Max speed (rpm)	7,100 rpm
Max outer diameter	527 mm
Max torque (Nm)	156,620 Nm

www.renold.com **RENOLD**
Superior Coupling Technology

D Series Gear Coupling



Max power / 100 rpm (kW)	2,209 kW
Max weight	374 kg
Max shaft size	197 mm
Max speed (rpm)	N/A
Max outer diameter	518 mm
Max torque (Nm)	211,000 Nm

www.renold.com **RENOLD**
Superior Coupling Technology

Croft MB Gear Coupling



Max power / 100 rpm (kW)	565 kW
Max weight	560 kg
Max shaft size	220 mm
Max speed (rpm)	3,730 rpm
Max outer diameter	930 mm
Max torque (Nm)	54,000 Nm

www.renold.com **RENOLD**
Superior Coupling Technology

Hydrastart Coupling



Max power / 100 rpm (kW)	39.1 kW
Max weight	207 kg
Max shaft size	127 mm
Max speed (rpm)	3,500 rpm
Max outer diameter	751 mm
Max torque (Nm)	N/A

www.renold.com **RENOLD**
Superior Coupling Technology

Hydrastart Drop-in Coupling



Max power / 100 rpm (kW)	39.1 kW
Max weight	N/A
Max shaft size	110 mm
Max speed (rpm)	2,500 rpm
Max outer diameter	751 mm
Max torque (Nm)	N/A

www.renold.com **RENOLD**
Superior Coupling Technology

Coupling Selection Guide

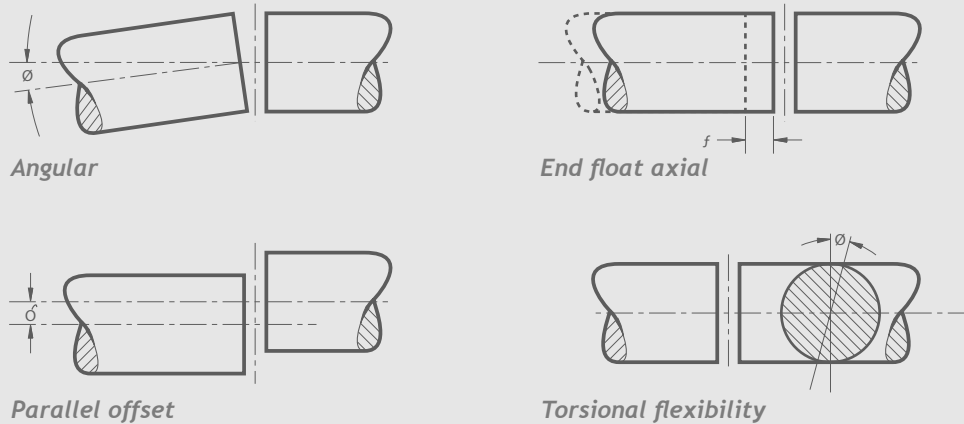

Flexible Couplings should be used to accommodate any combination of misalignment conditions described below.

At installation all couplings should be aligned as near to perfect as possible.

1. Angular

Angular misalignment is present when the shaft axes are inclined one to the other. Its magnitude can be measured at the coupling faces.

2. Parallel Offset

Parallel misalignment is present when the axes of the driving and driven shafts are parallel but laterally displaced.

3. End float (axial)

End float is the ability to accommodate a relative axial displacement of the connected shafts; achieved by sliding members or flexing of resilient components.

4. Torsional flexibility

Torsional flexibility is a design feature necessary to permit shock and impulsive loadings to be suitably dampened. It is achieved by the provision of a flexible medium such as rubber, springs, etc., between the two halves of the coupling.

Selection

In order to select the correct type and size of coupling, the following basic information should be known:

Power to be transmitted

- Normal.
- Maximum.
- Whether continuous or intermittent.

Characteristics of the drive

- Type of prime mover and associated equipment.
- Degree of impulsiveness of driven load.

Speed in revolutions per minute

- At which normal power is transmitted.
- At which maximum power is transmitted.
- Maximum speed.

Dimensions of shafts to be connected

- Actual diameter.
- Length of shaft extension.
- Full keyway particulars.

Selection

When the input drive is not steady (i.e. not from an electric motor), and/or the driven load is impulsive, the actual power is multiplied by a Service Factor from the Table 2 (page 13).

Selection Procedure

- Nominal power in kW to be transmitted = K .
- Select appropriate load classification from Table 1, denoted as either S, M or H.
- From Table 2, establish Service Factor(s) to be applied, taking into account hours of operation/day and prime mover = fD .
- From Table 3 select factor for the required frequency of starts/hr = fS .
- Selection Power $K_s = K \times fD \times fS$
- Equivalent power at 100 RPM = $\frac{K_s \times 100}{\text{RPM}}$
- Check that coupling selected will accept the required shaft diameters. Should shaft diameter exceed maximum permissible, then re-select using next larger size of coupling.

Load Classification by Application

Table 1

Agitators		Dry dock cranes		Planer feed chains	M	Presses	M
Pure liquids	S	Main hoist	(2)	Planer floor chains	M	Pulp machine reel	M
Liquids and solids	M	Auxiliary hoist	(2)	Planer tilting hoist	M	Stock chest	M
Liquids - variable density	M	Boom, luffing	(2)	Re-saw merry-go-round conveyor	M	Suction roll	M
Blowers		Rotating, swing or slew	(3)	Roll cases	H	Washers and thickeners	M
Centrifugal	S	Tracking, drive wheels	(4)	Slab conveyor	H	Winders	M
Lobe	M	Elevators		Small waste conveyor-belt	S	Printing presses	*
Vane	S	Bucket - uniform load	S	Small waste conveyor-chain	M	Pullers	
Brewing and distilling		Bucket - heavy load	M	Sorting table	M	Barge haul	H
Bottling machinery	S	Bucket - continuous	S	Tipple hoist conveyor	M	Pumps	
Brew kettles - continuous duty	S	Centrifugal discharge	S	Tipple hoist drive	M	Centrifugal	S
Cookers - continuous duty	S	Escalators	S	Transfer conveyors	M	Proportioning	M
Mash tubs - continuous duty	S	Freight	M	Transfer rolls	M	Reciprocating	
Scale hopper - frequent starts	M	Gravity discharge	S	Tray drive	M	single acting: 3 or more cylinders	M
Can filling machines	S	Man lifts	*	Trimmer feed	M	double acting: 2 or more cylinders	M
Cane knives (1)	M	Passenger	*	Waste conveyor	M	single acting: 1 or 2 cylinders	*
Car dumpers	H	Extruders (plastic)		Machine tools		double acting: single cylinder	*
Car pullers	M	Film	S	Bending roll	M	Rotary - gear type	S
Clarifiers	S	Sheet	S	Punch press - gear driven	H	Rotary - lobe, vane	S
Classifiers	M	Coating	S	Notching press - belt drive	*	Rubber and plastics industries	
Clay working machinery		Rods	S	Plate planners	H	Crackers (1)	H
Brick press	H	Tubing	S	Tapping machine	H	Laboratory equipment	M
Briquette machine	H	Blow moulders	M	Other machine tools		Mixed mills (1)	H
Clay working machinery	M	Pre-plasticiers	M	Main drives	M	Refiners (1)	M
Pug mill	M	Fans		Auxiliary drives	S	Rubber calenders (1)	M
Compressors		Centrifugal	S	Metal mills		Rubber mill, 2 on line (1)	M
Centrifugal	S	Cooling towers		Drawn bench carriage and main drive	M	Rubber mill, 3 on line (1)	S
Lobe	M	Induced draft	*	Pinch, dryer and scrubber rolls, reversing	*	Sheeter (1)	M
Reciprocating - multi-cylinder	M	Forced draft	*	Slitters	M	Tyre building machines	*
Reciprocating - single cylinder	H	Induced draft	M	Table conveyors nonreversing group drives	M	Tyre and tube press openers	*
Conveyors - uniformly loaded or fed		Large, mine etc.	M	Individual drives	H	Tubers and strainers (1)	M
Apron	S	Large, industrial	M	Reversing	*	Warming mills (1)	M
Assembly	S	Light, small diameter	S	Wire drawing and flattening machine	M	Sand muller	M
Belt	S	Feeders		Wire winding machine	M	Screens	
Bucket	S	Apron	M	Mills, rotary type		Air washing	S
Chain	S	Belt	M	Ball (1)	M	Rotary, stone or gravel	M
Flight	S	Disc	S	Cement kilns (1)	M	Travelling water intake	S
Oven	S	Reciprocating	H	Dryers and coolers (1)	M	Sewage disposal equipment	
Screw	S	Screw	M	Kilns other than cement	M	Bar screens	S
Conveyors - heavy duty not uniformly fed		Food industry		Pebble (1)	M	Chemical feeders	S
Apron	M	Beef slicer	M	Rod, plain & wedge bar (1)	M	Collectors	S
Assembly	M	Cereal cooker	S	Tumbling barrels	H	Dewatering screws	M
Belt	M	Dough mixer	M	Mixers		Scum breakers	M
Bucket	M	Meat grinder	M	Concrete mixers continuous	M	Slow or rapid mixers	M
Chain	M	Generators - not welding	S	Concrete mixers intermittent	M	Thickeners	M
Flight	M	Hammer mills	H	Constant density	S	Vacuum filters	M
Live roll	*	Hoists		Variable density	M	Slab pushers	M
Oven	M	Heavy duty	H	Oil industry		Steering gear	*
Reciprocating	H	Medium duty	M	Chillers	M	Stokers	S
Screw	M	Skip hoist	M	Oil well pumping	*	Sugar industry	
Shaker	H	Laundry		Paraffin filter press	M	Cane knives (1)	M
Crane Drives - not dry dock		Washers - reversing	M	Rotary kilns	M	Crushers (1)	M
Main hoists	S	Tumblers	M	Paper mills		Mills (1)	M
Bridge travel	*	Line shafts		Agitators (mixers)	M	Textile industry	
Trolley travel	*	Driving processing equipment	M	Barker - auxiliaries hydraulic	M	Batchers	M
Crushers		Light	S	Barker - mechanical	H	Calenders	M
Ore	H	Other line shafts	S	Barking drum	H	Cards	M
Stone	H	Lumber industry		Beater and pulper	M	Dry cans	M
Sugar (1)	M	Barkers, hydraulic, mechanical	M	Bleacher	S	Dryers	M
Dredges		Burner conveyor	M	Calenders	M	Dyeing machinery	M
Cable reels	M	Chain saw and drag saw	H	Calenders - super	H	Looms	M
Conveyors	M	Chain transfer	H	Converting machine except cutters, platers	M	Mangles	M
Cutter head drives	H	Craneway transfer	H	Conveyors	S	Nappers	M
Jig drives	H	De-barking drum	H	Couch	M	Pads	M
Manoeuvring winches	M	Edger feed	M	Cutters, platers	H	Range drives	*
Pumps	M	Gang feed	M	Cylinders	M	Slashers	M
Screen drive	H	Green chain	M	Dryers	M	Soapers	M
Stackers	M	Live rolls	H	Fell stretcher	M	Spinners	M
Utility winches	M	Log deck	H	Fell whipper	H	Tenter frames	M
		Log haul - incline	H	Jordans	M	Washers	M
		Log haul - well type	H	Log haul	H	Winders	M
		Log turning device	H			Windlass	*
		Main log conveyor	H				
		Off bearing rolls	M				

Key

S = Steady
M = Medium Impulsive
H = Highly Impulsive
* = Refer to Renold

(1) = Select on 24 hours per day service factor only.
(2) = Use service factor of 1.00 for any duration of service.
(3) = Use service factor of 1.25 for any duration of service.
(4) = Use service factor of 1.50 for any duration of service.

Note

Machinery characteristics and service factors listed in this catalogue are a guide only. Some applications (e.g. constant power) may require special considerations. Please consult Renold.

Service Factors and Selection

Table 2 Service Factor (f_D)

Prime mover (Drive input)	Driven machinery characteristics			
	Duration service hours/day	Steady load	Medium impulsive	Highly impulsive
Electric, air & hydraulic Motors or steam turbine (Steady input)	Intermittent - 3hrs/day max	0.90	1.00	1.50
	3 - 10	1.00	1.25	1.75
	over 10	1.25	1.50	2.00
Multi-cylinder I.C. engine (Medium impulsive input)	Intermittent - 3hrs/day max	1.00	1.25	1.75
	3 - 10	1.25	1.50	2.00
	over 10	1.50	1.75	2.25
Single-cylinder I.C. engine (Highly impulsive input)	Intermittent - 3hrs/day max	1.25	1.50	2.00
	3 - 10	1.50	1.75	2.25
	over 10	1.75	2.00	2.50

Table 3 Factor for Starts/Hour(f_S)

No of starts per hour	0-1	1-30	30-60	60-
Factor	1,0	1,2	1,3	1,5

Example of Selection

Coupling is required to transmit 7.5kW at 1440 RPM to connect an electric motor to a gear box driving a chain conveyor running for 18 hours/day and starting 15 times/hour. Shaft diameters /55mm respectively.

$$K = 7.5kW$$

From Table 1 Load Classification = M (medium impulsive)

From Table 2 Service Factor $f_D = 1.5$

From Table 3 $f_S = 1.2$

Therefore selection kW is:-

$$\begin{aligned} K_s &= K \times f_D \times f_S \\ &= 7.5 \times 1.5 \times 1.2 \\ &= 13.5 \text{ kW} \end{aligned}$$

$$\begin{aligned} \text{Equivalent power at 100 RPM} &= \frac{K_s \times 100}{\text{RPM}} \\ &= \frac{13.5 \times 100}{1440} \\ &= 0.9375kW @ 100RPM \end{aligned}$$

From page 17 selection is RSC110 (644911)
(maximum bore 55 mm).

Key Stress

1. Permissible key stress = 70N/mm²
2. Nominal torque $T_{KM} = K \times 9550 / \text{RPM Nm}$
3. Force at key $F = T_{KM} / r$
4. Shaft Rad r. metres
5. Key area $A = J \times \text{HUB length mm}$
(Obtain from relevant catalogue page).
6. Key stress $f_k = F/A \text{ N/mm}^2$
7. If resultant stress is less than 70 N/mm² key stress is acceptable.
If resultant f_k is greater than 70, consider either two keyways or extending hub length.

8. Example:

$$T_{KM} = 7.5 \times 9550/1440 = 49.7Nm$$

$$r = 55/2 = 27.5mm \div 1000 = 0.0275m$$

$$F = 49.7/0.0275 = 1741N$$

$$A = 16 \times 45 = 720mm^2$$

$$f_k = 1741/720 = \text{N/mm}^2$$

Selection is therefore good.

For operation above 80% of the declared maximum coupling speed it is recommended that the coupling is dynamically balanced.



WARNING

It is the responsibility of the system designer to ensure that the application of the coupling does not endanger the other constituent components in the system. Service factors given are an initial selection guide.



WARNING

Rotating equipment must be provided with a suitable guard before operating or injury may result.

Key and Keyway Dimensions

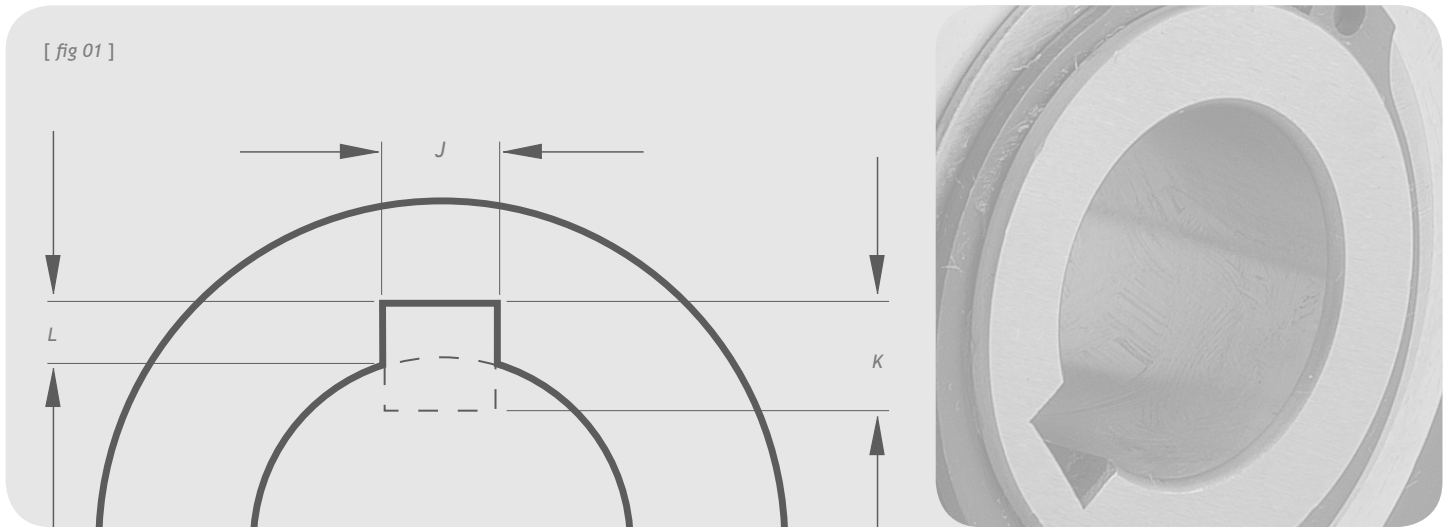

Metric (mm)

Keyways comply with BS4235: Part 1: 1972

Shaft dia.		Key & keyway		
Over	Incl.	J	K	L
6	8	2	2	1.0
8	10	3	3	1.4
10	12	4	4	1.8
12	17	5	5	2.3
17	22	6	6	2.8
22	30	8	7	3.3
30	38	10	8	3.3
38	44	12	8	3.3
44	50	14	9	3.8
50	58	16	10	4.3
58	65	18	11	4.4
65	75	20	12	4.9
75	85	22	14	5.4
85	95	25	14	5.4
95	110	28	16	6.4
110	130	32	18	7.4
130	150	36	20	8.4
150	170	40	22	9.4
170	200	45	25	10.4
200	230	50	28	11.4

Imperial (inches)

Keyways comply with BS46: Part 1: 1958

Shaft dia.		Key & keyway		
Over	Incl.	J	K	L
0.25	0.05	0.125	0.125	0.060
0.50	0.75	0.187	0.187	0.088
0.75	1.00	0.250	0.250	0.115
1.00	1.25	0.312	0.250	0.112
1.25	1.50	0.375	0.250	0.108
1.50	1.75	0.437	0.312	0.135
1.75	2.00	0.500	0.312	0.131
2.00	2.50	0.625	0.437	0.185
2.50	3.00	0.750	0.500	0.209
3.00	3.50	0.875	0.625	0.264
3.50	4.00	1.000	0.750	0.318
4.00	5.00	1.250	0.875	0.366
5.00	6.00	1.500	1.000	0.412

Keyway dimensions [fig 01]

Parallel keyways are supplied unless customer states otherwise.

Tyreflex



A range of highly flexible couplings offering excellent misalignment capacity and suitable to absorb both shock loads and vibrations.

Coupling capacity

- Maximum power @ 100RPM: 65.8 kW
- Maximum torque: 6270 Nm

Features and benefits

- High misalignment capabilities - high flexibility.
- Shock absorbing - extending machine life.
- Maintenance free - minimum number of wearing parts.
- Fire retardant, anti-static elements available for use in a flameproof environment.
- Interchangeability means no re-engineering.

- Pump spacer option for easy pump maintenance.
- Taper bush bores available for ease of replacement.
- Easy replacement of tyre element without any need to move hubs axially on driven or driving shafts.

Standard range comprises

- Shaft to Shaft
- Pump Spacer Type

Applications

- Compressors
- Generator Sets
- Pumps

- Roller Table Drives
- General Industrial Applications

Construction details

Steel or S.G. Iron Half Bodies

Rubber Tyres:

Temp Range -50°C to +50°C

Chloroprene Tyres:

Temp Range -15°C to +70°C



Can be certified for use in potentially explosive atmospheres containing gas or dust, according to ATEX directive 94/9/EC.

The couplings are classified for equipment group II, categories 2 and 3.

Contact Renold for further details.

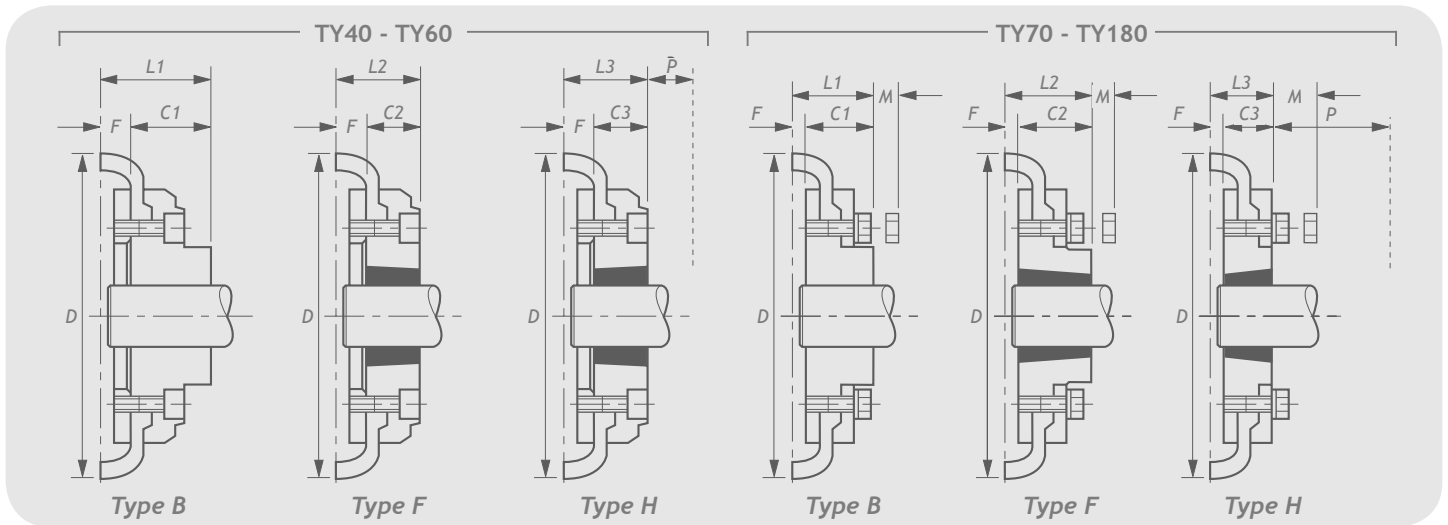

Coupling size	Power /100rpm kW	Torque nominal Nm	Speed max rpm	Type B		Type F		Type H		Max misalignment		End float mm	Torsional stiffness Nm° at 20°C		
				Bore		Bush size	Bore		Bush size	Bore				Parallel Offset mm	Angular deg
				Max	Min		Max	Min		Max	Min				
TY40 ##	0.26	25	4500	30	12	TB1008	25	9	TB1008	25	9	1.1	4	±1.3	6
TY50 ##	0.69	66	4500	38	15	TB1210	32	11	TB1210	32	11	1.3	4	±1.7	12.5
TY60 ##	1.33	127	4000	45	18	TB1610	42	14	TB1610	42	14	1.6	4	±2.0	32
TY70 ##	2.62	250	3600	50	22	TB2012	50	14	TB1610	42	14	1.9	4	±2.3	60
TY80 ##	3.93	375	3100	60	25	TB2517	60	16	TB2012	50	14	2.1	4	±2.6	63
TY90 ##	5.24	500	3000	70	28	TB2517	60	16	TB2517	60	16	2.4	4	±3.0	91
TY100 ##	7.07	675	2600	80	32	TB3020	75	25	TB2517	60	16	2.6	4	±3.3	126
TY110 ##	9.2	875	2300	95	30	TB3020	75	25	TB3020	75	25	2.9	4	±3.7	178
TY120 ##	13.9	1300	2050	110	38	TB3525	100	35	TB3020	75	25	3.2	4	±4.0	296
TY140 ##	24.3	2320	1800	130	75	TB3525	100	35	TB3525	100	35	3.7	4	±4.6	470
TY160 ##	39.4	3770	1600	140	85	TB4030	100	40	TB4030	100	40	4.2	4	±5.3	776
TY180 ##	65.8	6270	1500	150	85	TB4535	125	55	TB4535	125	55	4.8	4	±6.0	1370

Coupling size	Dimensions										Type B mass* kg	Type F mass* kg	Type H mass* kg
	C1 mm	C2 mm	C3 mm	D mm	F mm	L1 mm	L2 mm	L3 mm	M mm	P mm			
TY40 ##	22	22	22	104	11	33.5	33.5	33.5	N/A	29	1.05	1.05	1.05
TY50 ##	32	25	25	133	12.5	45	38	38	N/A	38	1.5	1.5	1.5
TY60 ##	38	25	25	165	16.5	55	42	42	N/A	38	2.35	2.35	2.35
TY70 ##	35	32	25	187	11.5	47	44	42	13	38	3.45	3.45	3.45
TY80 ##	42	45	32	211	12.5	55	58	45	16	42	5	5	5
TY90 ##	49	45	45	235	13.5	63	59	59	16	48	7.25	7.25	7.25
TY100 ##	56	51	45	254	13.5	70	65	59	16	48	10	10	10
TY110 ##	63	51	51	279	12.5	76	63.5	63.5	16	55	12.5	11.7	11.7
TY120 ##	70	65	51	314	14.5	84.5	78.5	65.5	16	67	16.9	16.5	15.9
TY140 ##	94	65	65	359	16	110.5	81	81	17	67	22.2	22.3	22.3
TY160 ##	102	77	77	402	15	117	92	92	19	80	35.8	33.5	32.5
TY180 ##	114	89	89	470	23	137	112	112	19	89	49.1	42.2	42.2

NOTE: M is distance by which clamping screws need to be withdrawn to release tyres.

P is wrench clearance for taper bush screws when large end is outboard Type H.

*Mass is for single hub assembly and half tyre.

Tyreflex

Ordering code

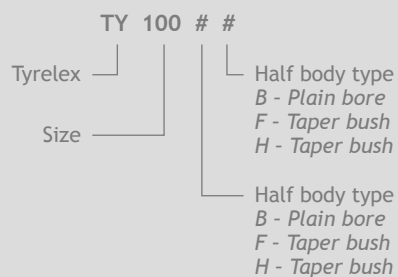

Component Spares

Coupling size	Tyre flexible element		Half body unbored Type B		Half body taper bored Type F		Half body taper bored Type H	
	Catalogue no	Product no	Catalogue no	Product no	Catalogue no	Product no	Catalogue no	Product no
TY40 # #	TY40	7131104/1	TY40 B	7131104/HB02	TY40 F	7131104/HB77	TY40 H	7131104/HB88
TY50 # #	TY50	7131105/1	TY50 B	7131105/HB02	TY50 F	7131105/HB77	TY50 H	7131105/HB88
TY60 # #	TY60	7131106/1	TY60 B	7131106/HB02	TY60 F	7131106/HB77	TY60 H	7131106/HB88
TY70 # #	TY70	7132107/1	TY70 B	7132107/HB02	TY70 F	713107/HB77	TY70 H	7132107/HB88
TY80 # #	TY80	7132108/1	TY80 B	7132108/HB02	TY80 F	7132108/HB77	TY80 H	7132108/HB88
TY90 # #	TY90	7132109/1	TY90 B	7132109/HB02	TY90 F	7132109/HB77	TY90 H	7132109/HB88
TY100 # #	TY100	7132110/1	TY100 B	7132110/HB02	TY100 F	7132110/HB77	TY100 H	7132110/HB88
TY110 # #	TY110	7132111/1	TY110 B	7132111/HB02	TY110 F	7132111/HB77	TY110 H	7132111/HB88
TY120 # #	TY120	7132112/1	TY120 B	7132112/HB02	TY120 F	7132112/HB77	TY120 H	7132112/HB88
TY140 # #	TY140	7132114/1	TY140 B	7132114/HB02	TY140 F	7132114/HB77	TY140 H	7132114/HB88
TY160 # #	TY160	7132116/1	TY160 B	7132116/HB02	TY160 F	7132116/HB77	TY160 H	7132116/HB88
TY180 # #	TY180	7132118/1	TY180 B	7132118/HB02	TY180 F	7132118/HB77	TY180 H	7132118/HB88

The best range of solution chain products available anywhere



RENOLD **Synergy**™

- High performance
- Superior wear life
- Outstanding fatigue resistance



RENOLD **Syno**™

- Maintenance free
- Self-lubricating chain
- Food industry-approved lubricant



RENOLD

- Best premium chain
- Leading performance
- Solid bush / solid roller / end softened pin



Hydro-Service™

- Superior corrosion resistant coating
- Alternative choice to stainless steel chain
- Will not chip or peel
- Hexavalent chrome-free



Steel Pin Bush Roller Chain

- Manufactured to international stds
- Full range of pitch alternatives
- Breaking loads 13 to 900 kN as std
- Attachments to suit varied applications

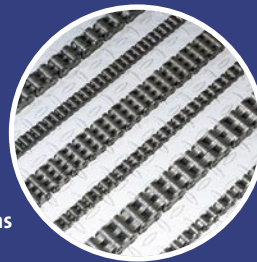

Leaf Chain

- Comprehensive ranges used worldwide for safety critical lifting applications
- 100 years experience in developing and maintaining lifting chain



Steel Knuckle Chain

- Heavy duty, detachable elevator chains
- Integral K type attachments
- Breaking loads from 642kN to 1724kN
- Sealed joint to extend chain life

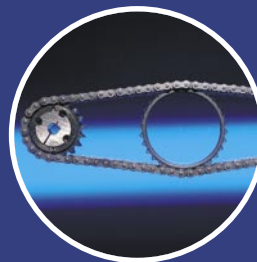

Roll-Ring™

- Revolutionary chain tensioner
- Installed in seconds and self adjusting
- Maintenance free
- Also acts as noise damper



Customised Engineering Chain

- Wide range to suit specialised applications using high specification materials and treatment processes
- Designed in close collaboration with customer



Smartlink™

- Load monitoring technology
- Technical reports & data logging

RENOLD
Superior Chain Technology

UK

Renold Clutches & Couplings
Cardiff
Tel + 44 (0) 29 20792737
Fax + 44 (0) 29 20791360
couplings@cc.renold.com

Renold Hi-Tec Couplings
Halifax
Tel + 44 (0) 1422 255000
Fax + 44 (0) 1422 320273
couplings@hi-tec.renold.com

Renold Gears
Milnrow
Tel + 44 (0) 1706 751000
Fax + 44 (0) 1706 751001
gears.sales@renold.com

USA

Renold Ajax
Westfield, New York State
Tel +1 716 326 3121
Fax + 1 716 326 8229
ainfo@renoldajax.com

WEB

www.renold.com

E-MAIL

enquiry@renold.com

For you nearest Renold dedicated specialist or distributor please visit the Renold website - www.renold.com or contact Renold UK

Whilst all reasonable care in compiling the information contained in this brochure is taken, no responsibility is accepted for printing errors. All information contained in this brochure is subject to change after the date of publication.