



Maintenance guide

for your Liniar products





Congratulations

on your brand new Liniar installation.

Whether you've purchased Liniar windows, doors, bi-folds, patio doors, French doors or a full conservatory, this guide will help you to keep your Liniar products looking, and working, their best for many years to come.

We've included performance, accreditation and warranty details, together with a variety of useful tips and information to help you follow the correct operating procedures and carry out simple maintenance.

Please spend some time to familiarise yourself with the contents to ensure you enjoy your Liniar installation and get the best from your investment. It is important you follow the guidance

in this manual to ensure warranties are maintained.

In the unlikely event of any difficulties, please contact your installer in the first instance, who will be pleased to help you.

Your Liniar installers details can be found on the back of this guide.

As Liniar has a policy of continuous improvement in products, methods and materials, changes in specification may be made from time to time without prior notice.

Note: Liniar products are technically engineered and require specialist parts and experience to install. Never attempt any repairs to a Liniar product yourself as this may invalidate your warranty – always contact your installer in the first instance.



Quality assured

The Liniar products you have purchased have been subjected to extensive testing during their design and build, with the company's UK-based PVCu extrusion facility accredited with ISO 9001:2000 for quality systems.

Accredited

In addition, Liniar products have attained the following industry accreditation:

- BS EN 12608:2003 (formerly BS7413) Unplasticized polyvinylchloride (PVCu) profiles for the fabrication of windows and doors.
- PAS 24 – Enhanced security performance for door assemblies.
- BBA accreditation for white casement and tilt & turn windows
- Secured by Design status for windows and doors
- Tested to the requirements of BS7412 – Plastics windows made from unplasticized polyvinylchloride (PVCu) extruded hollow profiles.





Contents

Cleaning	6
General Maintenance	8
Condensation	10
Ventilation	11
Heating	11
Circulation	11
Security	12
Glazing	13

Operation and Maintenance

Open out windows	14
Tilt & turn	16
Window restrictors	18
Residential doors	20
French/double doors	22
Patio doors	23
Bi-fold doors	24
Dos and Don'ts	26

Cleaning

Your Liniar products require a minimal amount of care in order to give you trouble-free operation and remain in optimum condition for many years to come.

The following information will show you the most effective to clean your Liniar windows, doors and roofs.

Standard PVCu frames

- Wash frames with a soap and water solution (dilute washing up liquid is fine) every four months to avoid the build-up of grime and atmospheric deposits.
- For stubborn stains, use a non-abrasive PVCu liquid cleaner. Use sparingly and buff to shine.
- Avoid solvent-based cleaners and take care not to disturb any sealants.

Coloured foiled PVCu frames

- Only use a soap and water solution to clean woodgrained or foiled windows.
- Never use cleaning fluid or solvent-based cleaners.
- Minor scratches can be repaired using a matching RAL touch-up pen

Glazed units

- Remove all hand jewellery prior to cleaning to avoid scratching.
- Remove any heavy external grime with a soap and water solution first.
- Use any proprietary household cleaner, applying with a soft cloth and buffing to a shine.
- Glass fitted with Georgian bars may be cleaned in exactly the same way.

Leaded glass

- If leaded strips are bonded to the glazed unit, take extra care as excessive pressure may dislodge the lead from the glass surface.
- Use a soft cloth with warm soapy water, applied with moderate pressure.
- Note that external lead will oxidise. This is a natural phenomenon and cannot be avoided.

Conservatory or porch roofs

Never try to walk on a conservatory roof – always use crawl boards to spread the load if you should need to access the roof.

Never lean ladders against PVCu frames, gutters or glass as this may result in damage.

Keep all gutters and outlets clear of leaves and other debris to maintain efficient operation.

Self cleaning glass

- Do not use abrasive or solvent-based cleaners on the external glazing surface as the self-cleaning properties may be affected.
- Use a soft cloth with warm soapy water and buff to a shine.
- A proprietary household cleaner may be used on the inside of the glass.

Polycarbonate

- Clean in a similar manner to PVCu frames, removing grime and atmospheric deposits every four months to avoid build-up.



General maintenance

Lubrication

All moving parts require periodic lubrication, and your Liniar windows and doors are no exception.

- For hardware and opening mechanisms, use light machine oil (for example, 3-in-1 or WD-40).

Drainage

All Liniar glazed products are designed with an in-built drainage system, comprising of slots within the lower thresholds that allow any water ingress to flow on the outside. To ensure an efficient system, these slots must remain unblocked.

Periodically remove dirt, clean drain holes and check the drainage operation by flushing through with water.

Handles and hardware

When installed, your hardware is protected with clear lacquer. Over time and through normal wear and tear, the lacquer may peel or become tarnished. Your installer cannot accept any responsibility for this as it is a natural occurrence.

You can refurbish the hardware in the following way:

- Take care to protect the PVCu surfaces from chemicals using masking tape and paper.
- Remove old lacquer with nail polish remover or paint stripper.
- Clean and polish the hardware with a suitable metal polish.
- Carefully re-lacquer using a good quality clear lacquer.

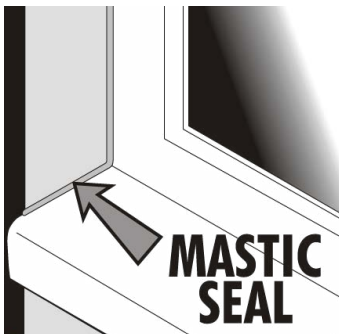

Mastic seal

The mastic seal is the waterproof seal found around your doors and windows.

Please note that some discolouration of the seal is a natural occurrence and cannot be avoided.



Condensation

Water vapour is naturally present in the atmosphere.

In the home, this natural water content is increased by normal day to day living – for example, activity that generates steam such as cooking, bathing, laundering, boiling a kettle and even breathing.

The water vapour remains undetectable while floating in warm air – but upon contact with cold surfaces such as windows, mirrors and tiles, condensation occurs as the vapour turns into water droplets.

Traditional house construction allowed the escape of this water vapour through natural ventilation, including open flues of coal fires, air bricks and ill-fitting

windows and doors – however the drive to conserve energy and reduce heating costs has led to the sealing of homes, resulting in trapped water vapour and increased problems of condensation.

With Liniar's highly energy efficient windows and doors, condensation can even form on the outside face of a double glazed unit, due to the outside surface being much colder than the inside – this is perfectly normal and nothing to worry about.



Ventilation

Provide ventilation in your home wherever possible by:

- Opening a window (please bear security in mind when leaving open an easily accessible window)
- Fitting a ventilation or extraction unit in the kitchen and bathroom
- Fitting wall vents to provide air flow.

Heating

Maintain some heat in the house during cold weather and marginally increase the temperature in areas where condensation is a particular problem.

If possible, fit radiators under windows to maintain the temperature of the inside pane of your double glazing.

An electric dehumidifier can help in problem areas by extracting excess vapour from the air.

Ventilation

Water vapour will easily drift from its originating point due to the convection currents in your home. To avoid this:

- Keep internal doors to kitchen and bathroom areas closed and draught-sealed where possible.
- Ensure bedrooms are ventilated at night to provide air movement. If doors must be closed, install a ventilation grille in or above the door.
- To ensure air flow in the vicinity of windows, curtains should be a minimum of 150mm (6") away from the window, with suitable gaps at the top and bottom.



Security

Your Linear windows, doors and roof have been specifically designed to include a number of security features to protect your home and family against intrusion.

Remember: prevention is better than cure.

We recommend the following sensible security precautions should also be taken:

- Never leave a window or door open when your home is unattended.
- Lock all windows whenever they are in the closed position and remove all keys.
- To provide adequate means of escape in an emergency, locate keys adjacent to the window but out of external view.
- When leaving the house unattended at night, ensure door handles are fully lifted and that the keys are turned, in order to throw and lock all deadbolts and shootbolts for full security.



Glazing information

Glass imperfections

All double and triple glazed units are susceptible to a degree of surface damage during the manufacturing process. Certain imperfections in the glass cannot be avoided, even in the most carefully controlled production environment.

Such blemishes and imperfections are therefore beyond our control, but are considered acceptable by even the most rigorous industry standards – we would like to draw your attention to the following extract from an industry-accepted standard in relation to glass:

1. Transparent glass used in the manufacture of double glazed units is identical to that used in traditional single glazing and will therefore have a similar level of quality.
2. Both panes of the double glazed unit shall be viewed from the room side, standing at a distance of two metres (6'6") in natural daylight and not in direct sunlight. The area to be viewed is the normal vision area, with the exception of a 50mm (2") wide band around the perimeter of the unit.
3. Flat transparent glass shall be deemed acceptable if the

following phenomena are neither obtrusive nor bunched:

- Totally enclosed seeds
 - Bubbles or blisters
 - Hairlines or blobs
 - Fine scratched, not more than 25mm (1") long
 - Minute embedded particles.
4. Obtrusiveness of blemishes shall be judged by looking through the glass and not at it, under normal lighting conditions as described in point 2.

Other glazing information

Your installer has used only the highest quality float glass available, whether laminated, toughened or annealed, which conforms to the requirements of BS 6262.

Double [and triple?] glazed units produced to BS 7513 conform to the highest manufacturing standards and the most uncompromising quality control and inspection routines.

Patterned glass originates in very large sheets and due to spacing repetition, centralisation of any design in a specific window cannot be guaranteed.

Operation and maintenance

Pages 14-24 will show you how to care for your Liniar products.

Open out windows

Liniar's windows may be opened outwards to any angle, and are fitted with friction hinges that hold it in any desired position when open.

The locking mechanism fitted to the opening edge of the window engages with slotted 'keeps' fitted to the outer frame. The secondary slot within the keep enables the window to provide a 'night vent' position, with the window only slightly open whilst providing ventilation.

NB: Accessible windows should not be kept in the 'night vent' position when the house is unoccupied.

To open, turn the key if fitted, then push the button in the centre and whilst pressed, turn the handle through 90° to unlock the handle. To close, simply turn the handle back the other way until it engages with the lock. Once closed, turn the key to lock the window and remove it to keep somewhere safe nearby.



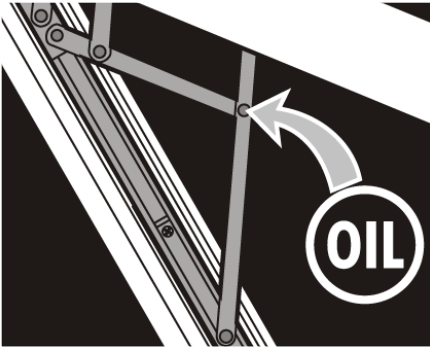

Maintenance

Friction hinges

To attain optimum performance the scissor mechanism of the friction hinges will require periodic lubrication. The pivots, sliding shoe and tracts should be kept free of dirt and debris.

Lubrication - as required

Oil all pivot points (one drop per pivot is sufficient) and wipe away excess.

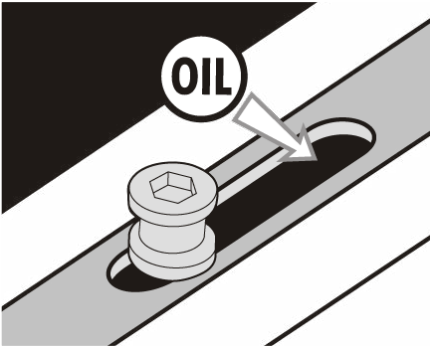

Espagnolette - locking mechanism

Lubricate - as required.

Keep the sliding mechanism free of dirt and lubricate each slot with light machine oil.

Keeps

Lubricate the slots of the keeps with petroleum jelly as required.

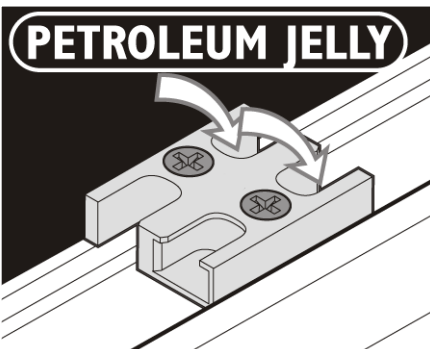

Handles - (espagnolette locking)

Clean and lightly oil moving parts.

Tilt & Turn windows

Liniar's versatile tilt and turn windows are fitted with 'tilt before turn' (TBT) handles for safety reasons – ensuring the window cannot be easily opened by children. This style of window is capable of two modes of operation:

- Tilt mode for ventilation
- Turn mode for cleaning and emergency exits

As the name suggests, the tilt mode must be performed prior to turning the window – however these windows may also be supplied in 'tilt before turn' mode where the sequence is reversed.

If you are in any doubt as to the sequence of operation for your windows, please contact your installer.

NB: The window must always be fully closed before changing the handle's position.

To operate the window, the handle should be in one of three positions: Closed, Tilt or Turn

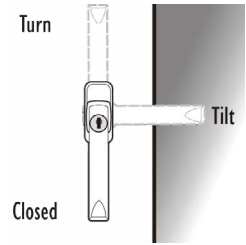

If fitted, turn the key to unlock the window.

To select Tilt mode, rotate the handle through 90° from downwards to horizontal, and pull the window inwards towards you. The bottom of the window will remain hinged to the frame, while the top tilts inwards to allow ventilation. When the key is removed, it is not possible to open the window fully.

To select Turn mode, close the window and rotate the handle through another 90° until it points upwards, then pull the window inwards. The side will now remain hinged to the frame while the window will open inwards to any desired position.



(SWITCH BARRIER)

DO NOT TOUCH

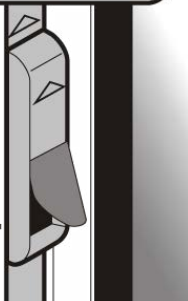

Maintenance

The switch barrier projecting from the locking mechanism, adjacent to the handle, is a safety device. It ensures that only one mode ('tilt' or 'turn') can be selected at any one time, by securing the handle into the selected mode, while the window is open.

Avoid pressing the switch barrier as this action releases the handle and could allow it to be inadvertently rotated to the alternative mode, resulting in the window disengaging from its gear.

Always firmly close the window before changing the handle position.



TBT locking mechanism

Keep sliding mechanism free of dirt as lubricate each slot with light machine oil as required.

Keeps

Lubricate the faces of the keeps with petroleum jelly as required.

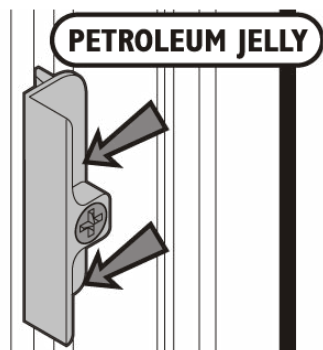

Handles

Clean and lightly oil moving parts.

Window restrictors

If fitted, the restrictor limits the opening of the window to control ventilation.

The restrictor may be disengaged to allow the window to be fully opened.

There are two main types of restrictor, the standard casement restrictor and the security restrictor.

Standard casement restrictor opening instructions

To open - restricted

Operate handle and open window. The restrictor arm will limit opening.

To open - fully

Once opened to the restricted position, close the window slightly and manually release the restrictor by lining up the slot opening with the striker post. While holding the latch, open fully.

To close

Close the window in the normal manner. The restrictor will automatically re-engage.



Security restrictor operating instructions

A special key is supplied to provide adjustment for the swinging arm and to enable the unit to be locked.

To open - restricted

Select required mode and open the window. The restrictor arm will limit opening.

To open - fully

Close window. While holding down control button, re-open the window. Release button as soon as window has cleared the frame.

To lock restrictor

Insert special key at the back of the unit and rotate clockwise half a turn.

Note: to provide adequate means of escape in the event of an emergency, we recommend that the keys to all windows are located adjacent to the window, but out of external view.

To adjust swinging arm

Insert the key into the socket at the side of the unit and rotate clockwise to tighten swinging arm or anti-clockwise to loosen.

Note: in the unlikely event that adjustment is needed, only a small movement (1/4 turn) will be required.

To close

Close the window in the normal manner. The restrictor will automatically re-engage.

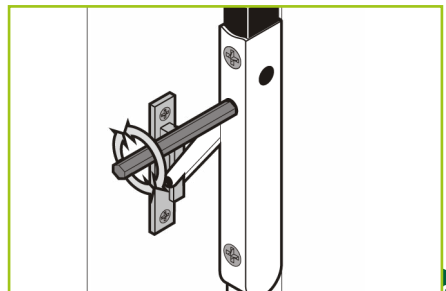
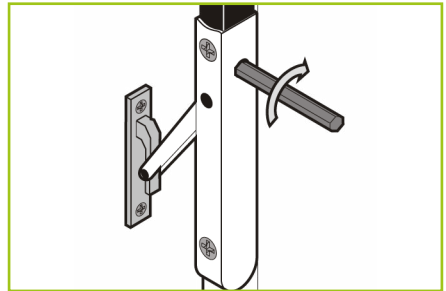
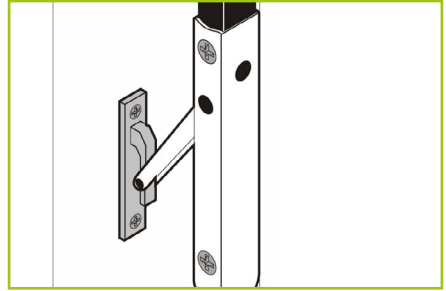

Liniar Residential Doors

Liniar PVCu doors are available in a variety of styles and operations.

Doors may be fitted with level/pad handles that limit outside opening by use of a key, or twin hookbolts and a single deadbolt combination with latch a lock.

In addition, up to 4 rollers may be present.

All locking points engage in keeps fitted to the jamb.

The top and bottom deadbolts, hookbolts and rollers (if fitted) are engaged by lifting the handle.

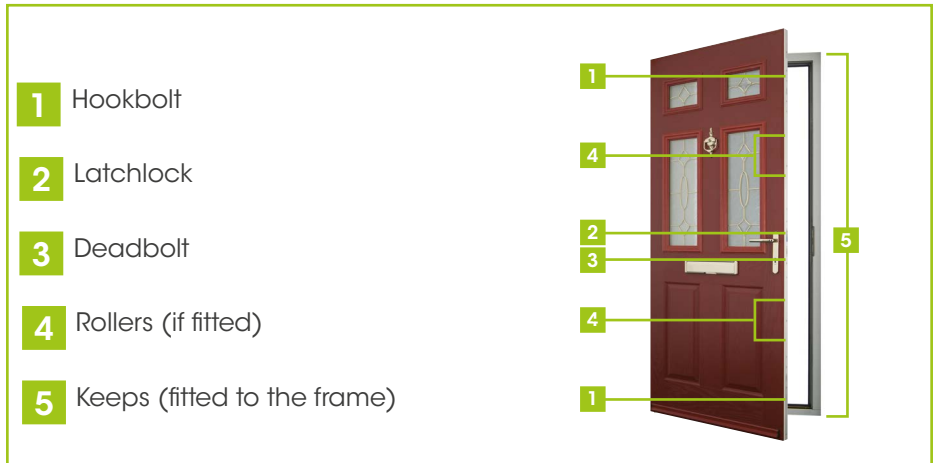

To lock

1. Close the door - catch engaged
2. Lift the handle or pad to engage the top and bottom deadbolts/hookbolts/rollers.
3. Insert key and turn to engage centre deadbolt and fully lock.

If the key will not turn, lift the handle or pad to maximum.

To unlock

1. Insert the key and turn to unlock
2. Press handle or pad down to disengage top and bottom deadbolts/hookbolts/rollers
3. With level handle, door will open
4. With pad handle, continue to turn key to open.

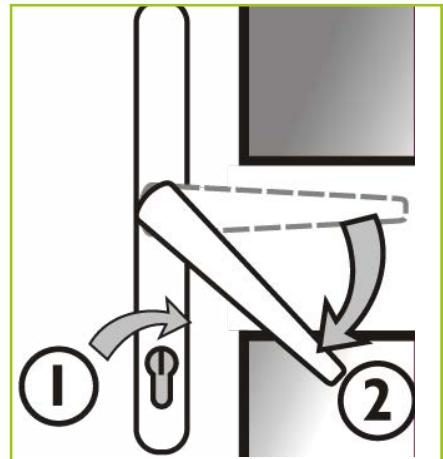
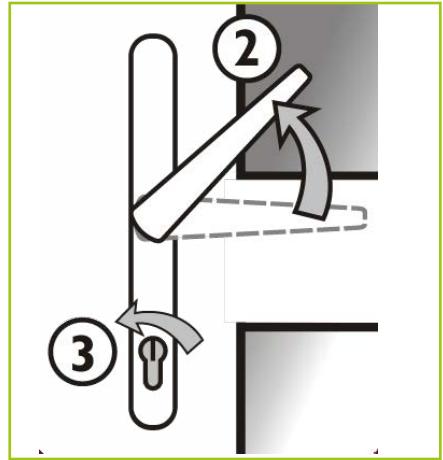

Maintenance

Lubricate the locking mechanism, handles and hinges if required but DO NOT add additional lubricant to the lock cylinder as this is packed with special grease.

To unlock

Clean and lightly oil external moving parts.

Locking mechanism

With door open, lubricate the deadbolts/hookbolts/rollers and latchlock with light machine oil.

Hinges

Clean and lightly oil hinge pins. If external, lubricate every 6 months.

French or double doors

Dependent upon the locking mechanism fitted to your door, there are three slave door locking options:

- Full slave locking (a handle-operated shootbolt that operates in the same way as the master door)
- Flushbolts (hand operated flushbolts fitted to the top and bottom of the slave door)
- Fingerbolts (hand operated fingerbolts fitted to the top and bottom of the slave door).

All Liniar double doors are fitted with high security multi-point locks.

Always open the master door first to avoid spraining the lock. Your installer should have shown you which door is the master, but it is usually the one with the full handle and lock. To lock the door after use, turn the handle upwards to engage the multi-point locks and then turn the key.

NB: If fingerbolts are fitted, ensure they are returned to their original positions when the slave door is open.



Maintenance

- Ensure frames are free of dirt by cleaning with soap and water
- Check drainage holes and remove any blockages
- Lubricate pivot point with light machine oil
- Minor scratches can be repaired using a matching RAL touch-up pen
- Check for obstructions, signs of wear and ensure fixing screws are secure.



Patio doors

Liniar patio doors are fitted with its patented integral high security ModLok™ locking mechanism, featuring a multi-point locking system and shoot-bolts with integral reinforcement, together with bespoke Liniar leaf-embossed handle.

To open, move the lock upwards, take hold of the handle and slide the door open.

To close and lock, simply slide the door into place and click the lock into the downward position.



Maintenance

- Ensure frames and tracks are free of dirt by cleaning with soap and water
- Check drainage holes and remove any blockages
- Lubricate pivot point with light machine oil
- Minor scratches can be repaired using a matching RAL touch-up pen
- Check for obstructions, signs of wear and ensure fixing screws

Bi-fold doors

Liniar's range of bi-folding doors is available in configurations from 2 to 7 panes, opening in or out. Your bi-fold will either be a Standard or ModLok bi-fold – the difference can be seen in the end panel of the door, as shown to the right.

If your bi-fold is a Standard model, you must be sure to open the master door first – if you try to open the slave door, you are at risk of spraining the lock.



If your bi-fold is a ModLok™ model, you will be unable to open the slave door first – the master door handle is the only one that can be opened first.

Opening operation

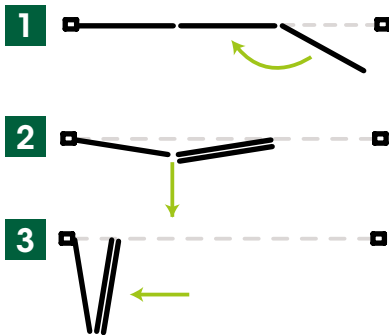

Before step 2, the door must be fully engaged with magnets.

Closing operation

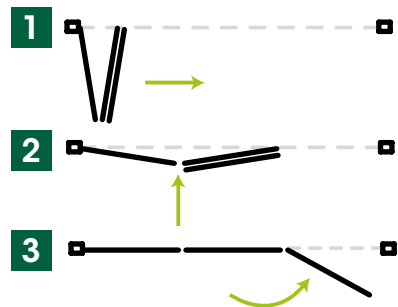

Before step 2, locking mechanism must be fully engaged.

Maintenance

- Rolling mechanisms carrying the doors panels are fitted with sealed stainless steel bearing and require no lubrication.
- Ensure top and bottom tracks are kept free from debris, which may impair the function.
- Door locking mechanisms should be cleaned and any moving parts lubricated with a light machine oil and least once a year and more frequently where appropriate.



Dos & Don'ts

The following section indicates simple best practice 'dos and don'ts' to ensure continual optimum performance of your windows and doors.

Do

- ✓ Clean the glass regularly with a good quality liquid spray glass cleaner
- ✓ Frequently wash down the PVCu profiles with warm soapy water and wipe dry
- ✓ Only use cleaning materials which do not impair anti-corrosion properties of the surface coatings
- ✓ Use cream cleaner for isolated stubborn stains on white PVCu only. Apply with a damp cloth using minimal pressure
- ✓ Ensure drainage slots are unblocked and free from dirt and debris
- ✓ Keep all tracks clear of dust and debris in order to reduce wear and tear on sliding parts
- ✓ Check all fire escapes hardware annually for a wear and tear and a consistent fit
- ✓ Ensure conservatory gutters and their outlets are kept clear of leaves and debris to ensure unobstructed flow
- ✓ All moving mechanical parts are lubricated - hinges, locks and keep plates will benefit from a small application of light oil at least once a year
- ✓ Replace damaged or worn parts with original Linar parts.

Do Not

- ✗ Use any type of bleach, solvent (e.g. white spirit, methylated spirits, nail varnish remover) or adhesives
- ✗ Use abrasives or brass cleaner on furniture: handles, door knockers, letter plates
- ✗ Use glass cleaner on the PVCu profile
- ✗ Use a ladder when cleaning your conservatory roof, always use a crawler board to evenly distribute your weight
- ✗ Use abrasive paste or cream cleaners on any PVCu profile
- ✗ Use high pressure or steam cleaners
- ✗ Use any abrasive papers, such as sandpaper
- ✗ Use excessive loads on the windows and doors
- ✗ Lean ladders against conservatory guttering
- ✗ Paint or try to remove paint
- ✗ Use any unspecified tools
- ✗ Use abrasive or solvent-based cleaners on self-cleaning glass.



Guaranteed

Liniar profiles are manufactured using tried and tested formulations from approved suppliers and will not warp, split or discolour for 10 years* from date of installation.

The guarantee is issued in association with our raw material suppliers and based on proven technology for UV stabilised products.

Further details, weathering data and full conditions can be supplied on request.

All products are to be installed to Liniar recommendations.



* Liniar Bi-fold doors are guaranteed for 5 years from date of installation.

7 great reasons to choose Liniar

Innovative - the only entirely new PVCu window and door profile system to be developed in the last 10 years

Energy efficient - designed from scratch to achieve the pinnacle of thermal performance and retain more heat in your property

Safe and secure - engineered with built-in security features and approved by independent testing facilities

British made - frames are extruded in our state-of-the-art factory in the heart of Derbyshire

Lead free - all Liniar profiles are extruded using materials that are 100% lead free

Quality assured - backed with ISO 9001 accreditation for your peace of mind

Guaranteed - all Liniar frames are guaranteed to not warp, split or discolour for a minimum of 10 years



Your Liniar stockist is:

Liniar
Flamstead House
Denby Hall Business Park
Denby
Derbyshire DE5 8JX

Tel: +44 (0)1332 883900
Fax: +44 (0)1332 883901
Email: sales@liniar.co.uk

www.liniar.co.uk

