



simple
solutions



EA
Earth Anchors Ltd

15 Campbell Road, Croydon,
Surrey CR0 2SQ, United Kingdom.
Tel: 020 8684 9601
Fax: 020 8684 2230
www.earth-anchors.com

litter bins	2	●
Wheelistat	9	●
planters	10	●
Healthguard® dog waste bins	12	●
seats & benches	16	●
tables	24	●
commemorative seating options	29	●
commemorative angled plate	31	●
stainless steel	32	●
Rootfast® anchorage system	36	●

Earth Anchors furniture for parks and streets is used extensively by local authorities and private developments throughout the UK.

We understand your need for furniture that offers value for money, usability, low maintenance and long life.

All products are designed to incorporate our patented **Rootfast®** anchoring system, giving benefits of rapid and cost effective installation.

Your needs drive the development of our products and range.

A current price list and installation instructions can be downloaded from our website: earth-anchors.com



litter bins



simple
solutions





litter bins



Beau & Belle ●

- 42 litres capacity
- all steel construction
- liner: heavy gauge steel, zinc coated & polyester powder coated
- cage: galvanised or colour coated finish
- Fastlock security
- **Rootfast®** anchorage or bolt down



litter bins



Bensham ●

- 82 & 145 litres capacity
- all steel construction
- liner: heavy gauge steel, zinc coated & polyester powder coated
- cage: galvanised or colour coated finish
- Fastlock security
- available with locking lid (82 litre only)
- **Rootfast®** anchorage or bolt down



optional steel lid

Big Ben ●

- 82 litres capacity
- all steel construction
- liner: heavy gauge steel, zinc coated & polyester powder coated
- cage: galvanised or colour coated finish
- Fastlock security
- available with locking lid
- **Rootfast®** anchorage or bolt down



optional name or logo can be supplied



Ranger ●

- 107 litres capacity
- all steel construction
- heavy gauge steel, zinc coated & polyester powder coated
- slam-shut door
- Fastlock security
- available in stainless steel, see page 35
- **Rootfast®** anchorage or bolt down



litter bins



Sentinel (lidded)

- 107 litres capacity
- all steel construction
- lidded or open top
- liner: heavy gauge steel, zinc coated & polyester powder coated
- slam-shut door
- Fastlock security
- **Rootfast**® anchorage or bolt down



Sentinel (open top)



litter bins



Warden

- 82 litres capacity
- pressure treated half round timbers on galvanised steel frame
- galvanised lift-out steel liner
- cast aluminium "LITTER" sign
- Fastlock security
- **Rootfast**® anchorage or bolt down



Rustic

- 90 litres capacity
- pressure treated half round timbers on brown coated steel frame
- galvanised lift-out steel liner
- cast aluminium "LITTER" sign
- Fastlock security
- **Rootfast**® anchorage or bolt down



litter bins



optional sealed lid



optional rigid liner



Civic

- 35 litres capacity
- rotational moulded plastic
- open top or sealed lid
- colours: **body** - red or grey
sealed lid - black or red
open lid - green or black
- range of fixings as HGN35, see page 14

OPTIONS

- NEAT-A-SAC stretch liners in heavy duty (70 microns) plastic
- liner, in rigid black polythene with internal handles
- wide range of fixings including **Rootfast®** anchorage

Forest-Saver

- 90 litres capacity
- Forest-Saver cladding
- colour coated cage
- Fastlock security
- **Rootfast®** anchorage or bolt down

*Forest-Saver recycled material:

- does not require staining or painting
- never rots
- is graffiti resistant
- does not fade or discolour



dual bin and cigarette bin



optional NEAT-A-SACS



Healthguard® dual bin stations

- litter and dog waste
- combination of 45 and 66 litres capacity
- pedal option
- **Rootfast®** anchorage



inner container



Cigarette bin

- stainless steel construction
- large 6 litre capacity
- contemporary design
- locked, galvanised inner container
- wall mounted supplied with fixing bolts
- post mounting fittings and posts available



Wheelistat



Wheelistat ●

- prevents theft and misuse of wheeled bins
- adjustable to fit bins of up to 360 litres
- limits opening of lid to prevent dumping of large items
- simple, easy to use Fastlock mechanism to release bin from post
- **Rootfast®** anchored post or hard surface fittings



Earth Anchors

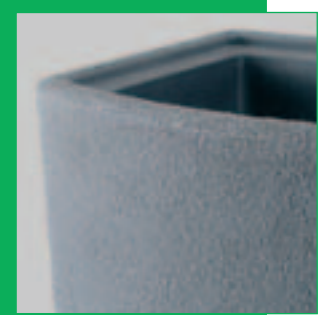

self watering planter

simple solutions





self watering planter



onyx

planter ●

- units are watertight for internal use
- overall dimension: length 1000mm
width 600mm
height 550mm
- self watering from integral 95 litre reservoir allowing good circulation to plant roots
- rugged UV resistant recyclable polyethylene
- colours: - onyx or white granite
- slots in base to allow forklifting of the planters
- can be used individually or together to suit your particular scheme



integral reservoir



white granite

Earth Anchors



simple
solutions



Healthguard® dog-waste bins



Healthguard® dog-waste bins



HGN45

Dog waste bins really work.

That is the opinion of most local authorities and others who install them. Healthguard® dog waste bins are used extensively throughout the UK and have been for nearly 20 years. The Healthguard® range of bins has been developed to satisfy the needs of buyers and users of dog bins.

HGN steel bin

- 45 or 66 litres capacity
- bin: constructed from heavy gauge, zinc coated steel and polyester powder coated
- post: steel, galvanised
- simple sack operation prevents raw waste contamination and speeds cleaning
- bag retainer keeps liner bag neatly inside
- dog logo as shown
- standard colours red and green, other colours available
- wide range of fixing options including **Rootfast®** anchorage
- HGN45 - 45 litres capacity
- HGN66 - 66 litres capacity



Fastlock security



HGN66



Healthguard® dog-waste bins

HGN options and specifications

35 litre

- HGN35 for mounting onto your existing post
- HGN35LC for mounting on lamp-post with access hatch
- HGN35W wall mounting with expanding bolts (included)
- HGN35R railing mounting
- HGN35B supplied with post for bolting to hard surfaces
- HGN35C supplied with post for setting into concrete
- HGN35A supplied with **Rootfast®** anchored post
- HGN35PA bin and fitting for fixing to HGN45/66 post

45 litre

- HGN45A **Rootfast®** anchored, post mounted bin with or without pedal operation
- HGN45B for bolting to concrete with or without pedal operation
- HGN45C for setting into concrete with or without pedal operation
- HGN45W wall mounting bin
- HGN45R railing mounting bin
- HGN45P post mounting bin for 60, 76 and 89mm (post dia)
- HGN45LC lighting column mounting bin

66 litre

- HGN66A **Rootfast®** anchored, post mounted bin with or without pedal operation
- HGN66B for bolting to concrete with or without pedal operation
- HGN66C for setting into concrete with or without pedal operation
- HGN66W wall mounting bin
- HGN66R railing mounting bin
- HGN66P post mounting bin for 60, 76 and 89mm (post dia)
- HGN66LC lighting column mounting bin

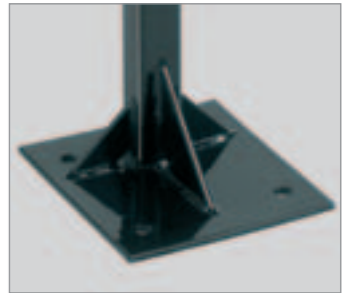

bolt down post and colour coating



HGN-ISP integral sign post and sign



bag lock / chute operation



bin colour options
customised signs to quotation



pedal operation of lid

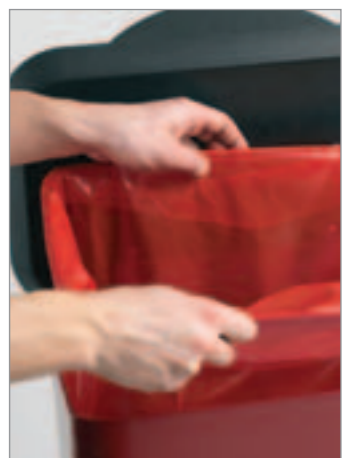

NEAT-A-SAC stretch liners



Healthguard® dog-waste bins



NEAT-A-SAC stretch liners



HGN35 compact bin

- 35 litres capacity
- rotational moulded plastic
- sealed lid
- colours: **body** - red or grey
lid - black or red
- wide range of fittings for post, lighting column, wall or railing mountings
- posts: **Rootfast**® anchored, bolt down or setting into concrete

OPTIONS

- NEAT-A-SAC stretch liners
- liner, in rigid black polythene with internal handles
- stainless steel banding



HGN35LC with adjustable brackets to avoid hatch

Earth Anchors



seats & benches

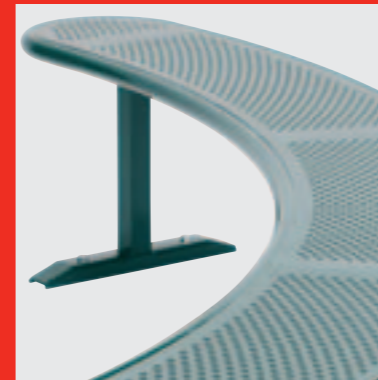

simple
solutions





seats & benches

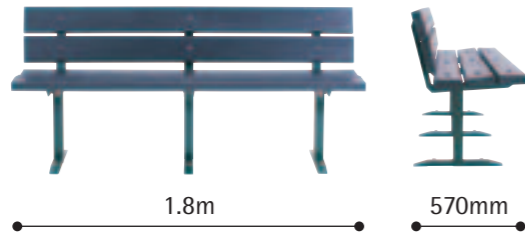

Forest-Saver seat ●

- 5 *Forest-Saver boards
- 3 steel support frames
- anti-vandal fittings
- galvanised or colour coated frames
- optional armrests, 2No or 4No

- **Rootfast®** anchorage or bolt down



Evergreen seat ●

- 5 *Forest-Saver boards
- heavy duty cast iron frames with arms
- steel centre support
- anti-vandal fittings
- colour coated
- optional additional armrests, 2No

- **Rootfast®** anchorage or bolt down

- *Forest-Saver recycled material:
- does not require staining or painting
 - never rots
 - is graffiti resistant
 - does not fade or discolour



seats & benches

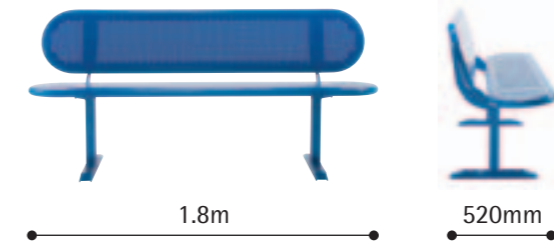

Ranger seat ●

- all steel construction - (also available in stainless steel, see page 34)
- combats vandalism including arson
- polyester powder coated, available in a wide range of colours
- anti-vandal fittings
- optional armrests, 2No

- **Rootfast®** anchorage or bolt down

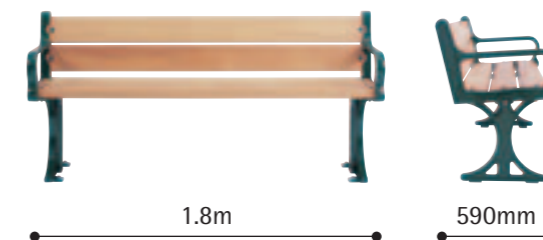

Centenary seat ●

- 5 large section iroko hardwood boards
- heavy duty cast iron frames with arms
- anti-vandal fittings
- colour coated
- optional armrests, 2No

- **Rootfast®** anchorage or bolt down



seats & benches



Easy Riser seat ●

- easy for the elderly and infirm to use
- steel seat and armrest supports
- iroko hardwood boards and arm pads
- galvanised or colour coated frames
- choice of lengths - 2 metre with 4 arms & 2.4 metre with 5 arms

- **Rootfast®** anchorage or bolt down



Frigate seat ●

- steel support frames
- iroko hardwood boards
- galvanised or colour coated frames
- available in 2 or 2.4 metre lengths
- optional armrests, 2No, 3No or 4No

- **Rootfast®** anchorage or bolt down



seats & benches

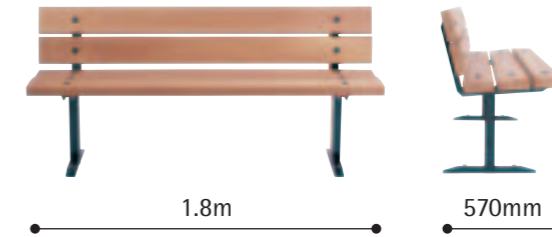

Parklane seat ●

- 5 large section iroko hardwood boards
- steel support frames
- galvanised or colour coated frames
- optional armrests, 2No or 3No

- **Rootfast®** anchorage or bolt down

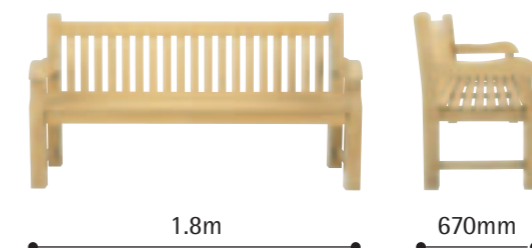

Meridian seat ●

- traditional timber seat design
- teak construction throughout
- heavy duty sections

- **Rootfast®** anchorage or bolt down



seats & benches

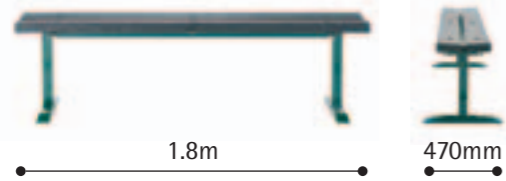

Forest-Saver bench ●

- *Forest-Saver boards
- steel frames
- full length board support
- anti-vandal fittings
- galvanised or colour coated frames
- **Rootfast®** anchorage or bolt down



Evergreen bench ●

- *Forest-Saver boards
- heavy duty cast iron frames
- full length board support
- anti-vandal fittings
- colour coated
- **Rootfast®** anchorage or bolt down

- *Forest-Saver recycled material:
- does not require staining or painting
 - never rots
 - is graffiti resistant
 - does not fade or discolour



seats & benches

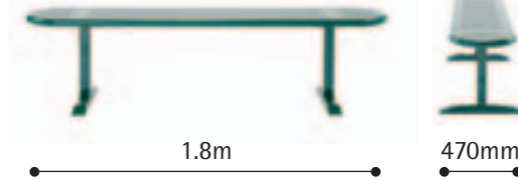

Ranger bench ●

- all steel construction - (also available in stainless steel, see page 34)
- highly vandal resistant
- polyester powder coated, available in a wide range of colours
- anti-vandal fittings
- **Rootfast®** anchorage or bolt down

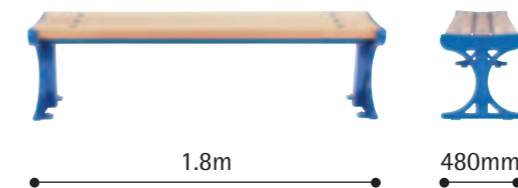

Centenary bench ●

- large section iroko hardwood boards
- heavy duty cast iron frames
- anti-vandal fittings
- colour coated
- **Rootfast®** anchorage or bolt down



seats & benches



Ranger curved bench

- attractive curved form
- 3 metre length
- all steel construction
- highly vandal resistant
- polyester powder coated, available in a wide range of colours
- anti-vandal fittings
- **Rootfast®** anchorage or bolt down

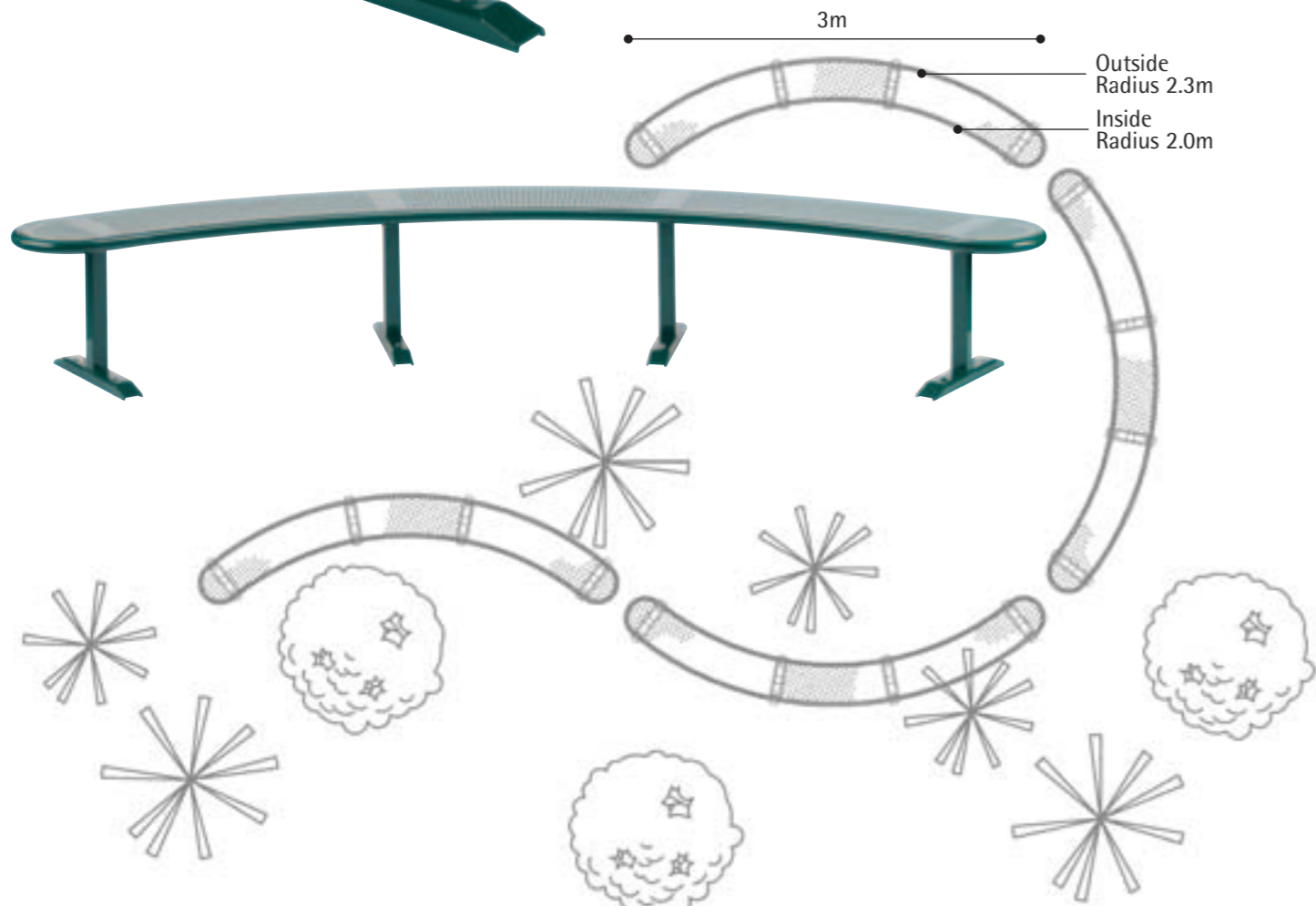

Earth Anchors



simple solutions



tables

tables



Forest-Saver picnic table with backrests

Forest-Saver picnic table, backless type



Forest-Saver picnic table

- *Forest-Saver boards
- steel frames
- full length board support
- galvanised or colour coated frames
- anti-vandal fittings
- 1.8 metres long
- **Rootfast®** anchorage or bolt down

*Forest-Saver recycled material:

- does not require staining or painting
- never rots
- is graffiti resistant
- does not fade or discolour



Mobility picnic table

- extended table end to allow wheelchair users full access
- available with backrests or without (as shown)
- **Rootfast®** anchorage or bolt down

tables

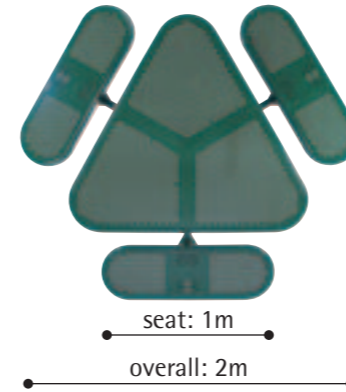

Ranger Tri-Table

- easy access
- all steel construction - (also available in stainless steel, see page 33)
- polyester powder coated, available in a wide range of colours
- anti-vandal fittings
- weight - 97kgs
- **Rootfast®** anchorage or bolt down



Mobility Ranger Tri-Table

- special seat pan allows wheelchair users full access to the table
- can be supplied with any combination of standard or special seat pans
- **Rootfast®** anchorage or bolt down



Forest-Saver Tri-Table, backless

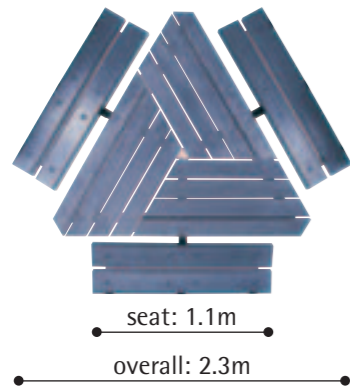

Forest-Saver Tri-Table

- *Forest-Saver boards
- steel support frames
- galvanised or colour coated frames
- anti-vandal fittings
- **Rootfast®** anchorage or bolt down



Shearnut anti-vandal fittings



Forest-Saver Tri-Table with backrests

- *Forest-Saver recycled material:
- does not require staining or painting
 - never rots
 - is graffiti resistant
 - does not fade or discolour



timber Tri-Table, backless

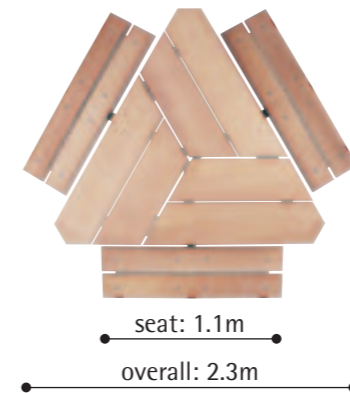

Timber Tri-Table

- large section iroko hardwood boards
- steel support frames
- galvanised or colour coated frames
- **Rootfast®** anchorage or bolt down



timber Tri-Table with backrests



commemorative seating options



standard sizes	
Plaque size	No. of characters
6" x 2" (152 x 51mm)	50
7" x 2" (178 x 51mm)	50
8" x 2 1/2" (203 x 63.5mm)	60
9" x 2 1/2" (229 x 63.5mm)	75
11" x 2 1/2" (279 x 63.5mm)	90
13" x 2 1/2" (330 x 63.5mm)	100

cast bronze plaques

The table left is a guide to standard sizes

- supplied recessed into seat boards
- excellent corrosion resistance and durability
- available for all Forest-Saver and timber seats and tables

Cast plaques and engraved brass plates supplied in a wide range of sizes

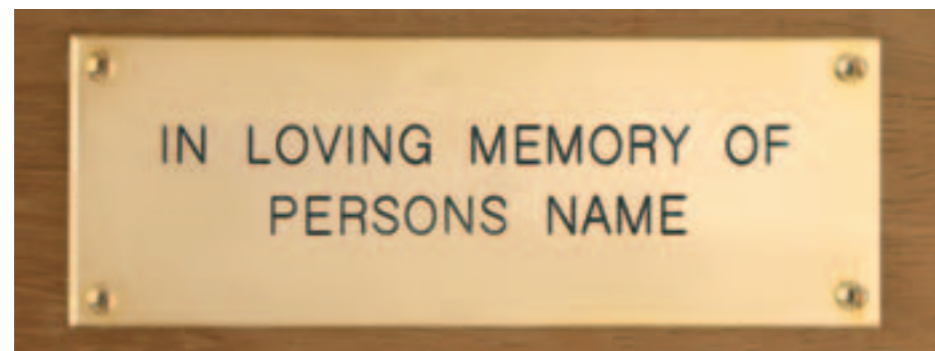

engraved brass plates

- supplied fitted to seat boards
- standard size - 6 x 2 inches with up to 50 characters
- black letters
- available for all seats and tables



commemorative seating options



engraved seat boards

- available for Forest-Saver and timber seats and tables
- upper and lower case characters
- Helvetica font
- standard character height 25mm





commemorative angled plate

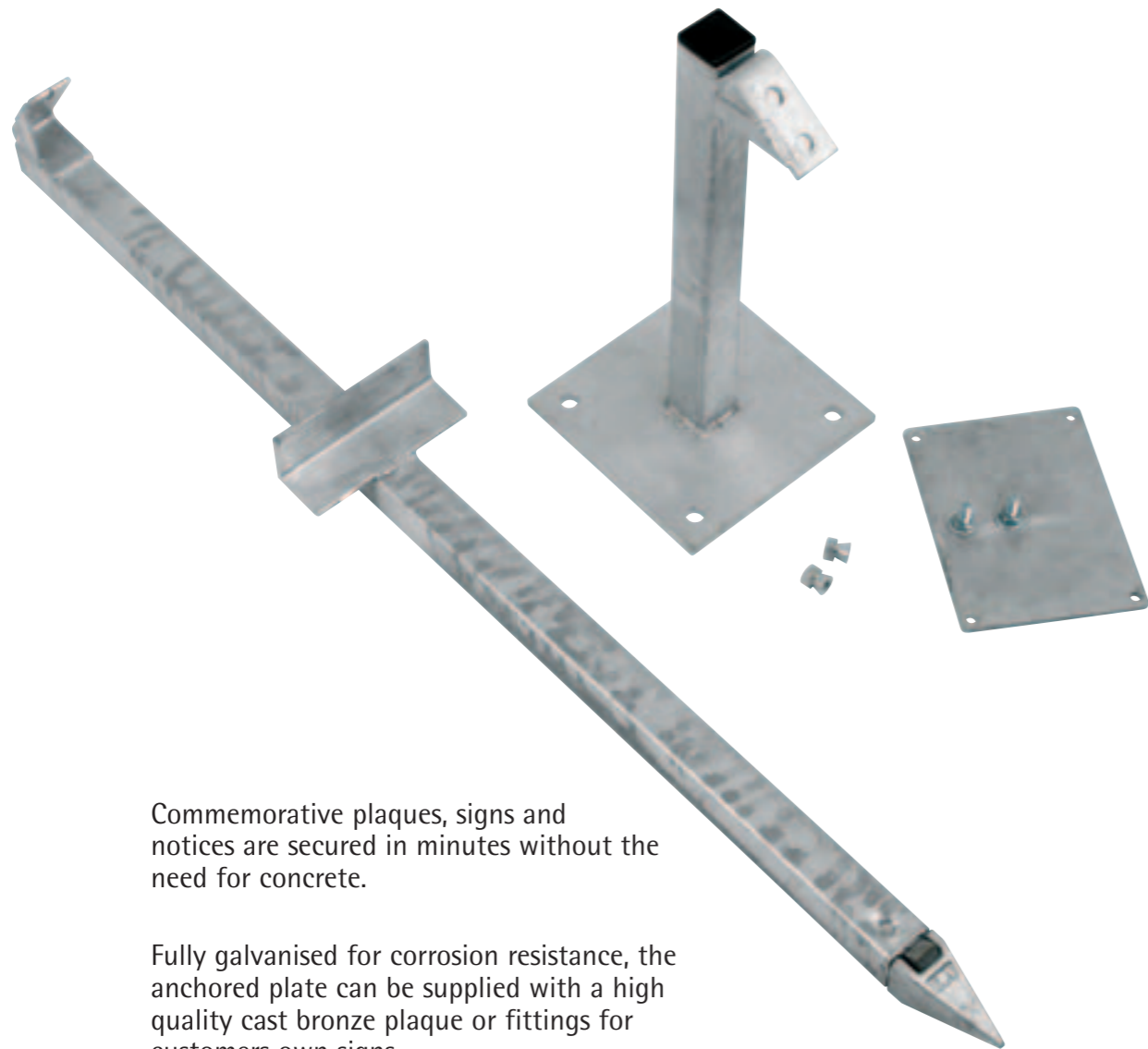

Commemorative plaques, signs and notices are secured in minutes without the need for concrete.

Fully galvanised for corrosion resistance, the anchored plate can be supplied with a high quality cast bronze plaque or fittings for customers own signs.



cast bronze angled plate

- galvanised finish
- tamperproof fittings
- installed in minutes
- optional 8 x 6 inch cast bronze plaque with high definition finish
- other sign types and sizes to quotation
- 440mm above ground height
- **Rootfast®** anchored into soft ground or bolt down fixing for concrete

Earth Anchors



stainless steel

simple solutions





stainless steel

Stainless steel is an ideal material for external furniture. It is attractive, tough, durable and will never rust. Graffiti can be removed without damaging the furniture and even the effects of arson can usually be removed without damage. The overall life cost of stainless steel furniture can be lower than alternative materials.

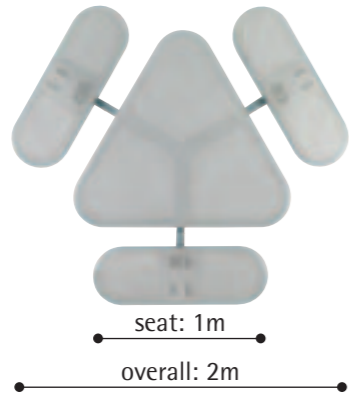

Ranger Tri-Table ●

- easy access
- stainless steel seat pans and table top, galvanised support frames
- anti-vandal fittings
- weight - 97kgs
- **Rootfast®** anchorage or bolt down



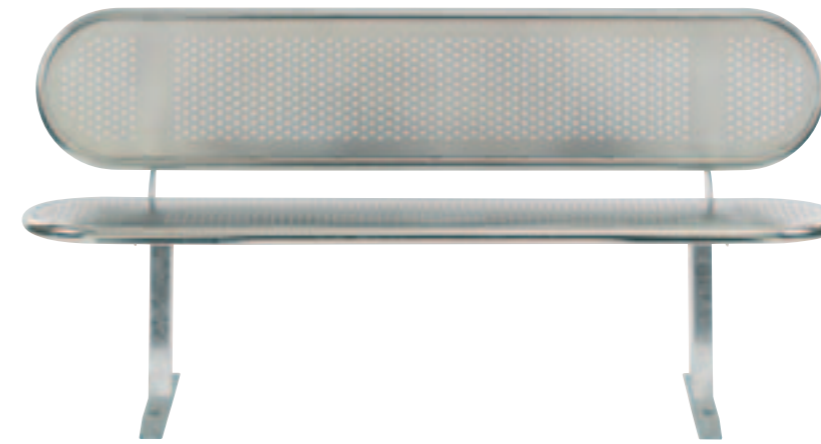

stainless steel

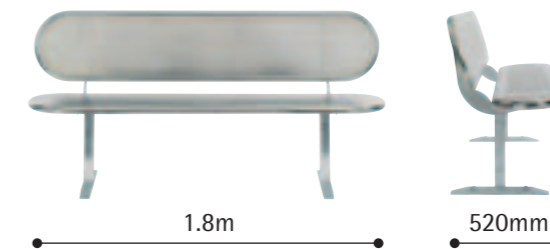

Ranger seat ●

- combats vandalism including arson
- stainless steel seat pan and back, galvanised supports
- anti-vandal fittings
- **Rootfast®** anchorage or bolt down



Ranger bench ●

- highly vandal resistant
- stainless steel seat pan, galvanised supports
- anti-vandal fittings
- **Rootfast®** anchorage or bolt down

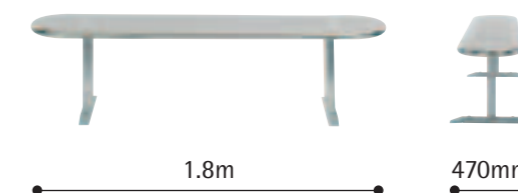



stainless steel



Ranger 100 bin ●

- 107 litres capacity
- stainless steel construction, galvanised liner
- Fastlock security
- **Rootfast®** anchorage, bolt down or freestanding



Cigarette bin ●

- large 6 litre capacity
- stainless steel construction
- locked steel inner liner
- easy to empty
- wall or post mounting
- optional posts



Earth Anchors



simple solutions

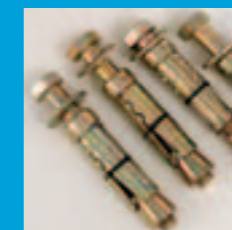

Rootfast® anchorage system

Rootfast® anchored posts

Rootfast® anchored posts are the easy way to install permanent posts using simple tools and eliminating the need for digging and concreting.

Anchor sign post

- Rootfast® anchored
- installed using simple tools
- no digging or concreting required
- galvanised finish
- available in 1.2m, 1.6m and 2m above ground height
- screen printed signs and fittings available

Ref.	Section	Above ground height
AP44 - 2000	40 x 40	1.2m
AP44 - 2500	40 x 40	1.6m
AP44 - 3000	40 x 40	2.0m
AP50 - 2000	40 diameter	1.2m
AP50 - 2500	40 diameter	1.6m
AP50 - 3000	40 diameter	2.0m
ABP - 1200	76 diameter	1.2m
ABP - 1600	76 diameter	1.6m
ABP - 2000	76 diameter	2.0m

Rootfast® anchorage system

Boundary posts

- For demarcation of cricket pitches and other areas.
- easily installed with simple tools and a hammer
- galvanised finish on all components
- reflective cable and clamps available separately
- removable post with locking ring
- Rootfast® anchored socket and locking ring

Lifebuoy station

- complete station consists of post, SOLAS approved lifebuoy and line
- wall or railing mountings available
- 24" or 30" SOLAS lifebuoys

OPTIONAL

- triangular warning sign

Rootfast® anchorage system



All Earth Anchors furniture can be permanently secured into soft or unmade ground using our patented Rootfast® anchoring system.

The anchor is installed using a set of reusable tools. You avoid the expense and hassle of digging holes and making concrete. The furniture is secured and ready for immediate use.

- quick and easy installation into soft ground
- cost effective
- permanent fixing
- immediate security and use
- ideal for use in areas where access is restricted
- avoids digging, concrete and removal of excavated material

Installation instructions for most products can be downloaded from our website: earth-anchors.com

a typical Rootfast® bin installation ●

Rootfast® anchorage system



a typical Rootfast® seat installation ●

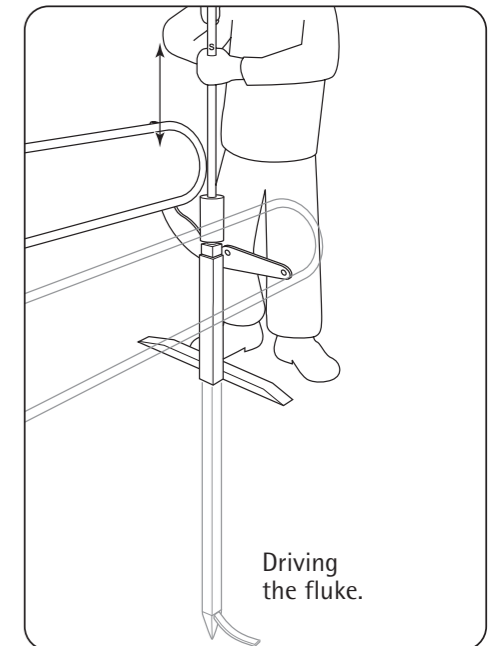
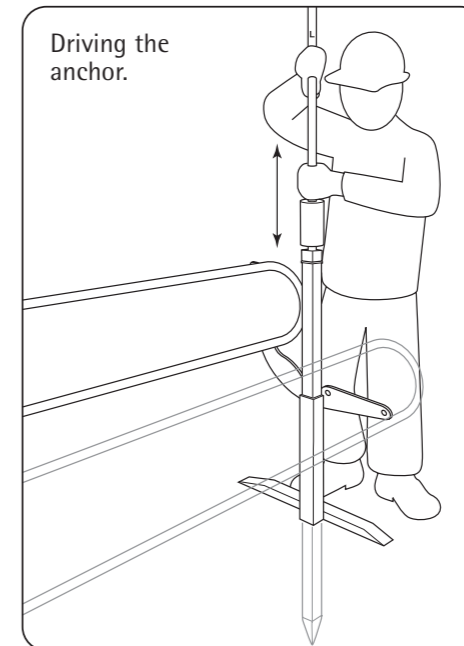
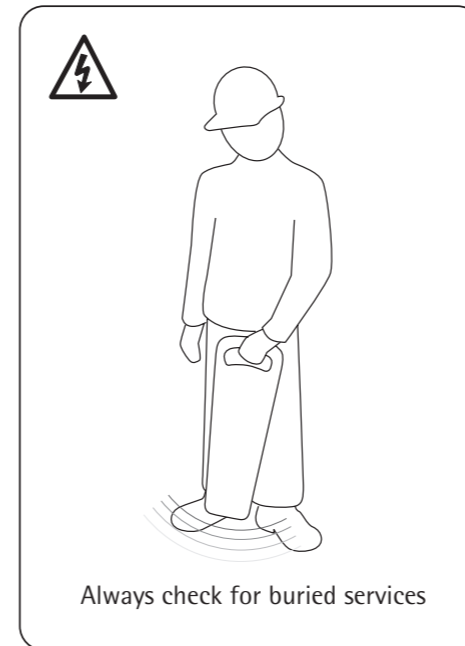
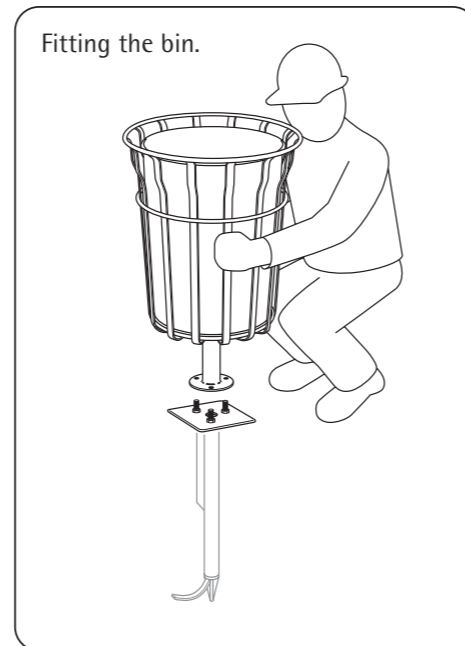
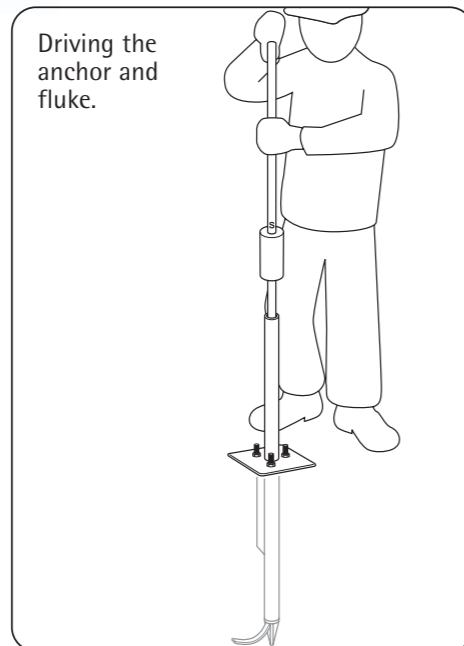
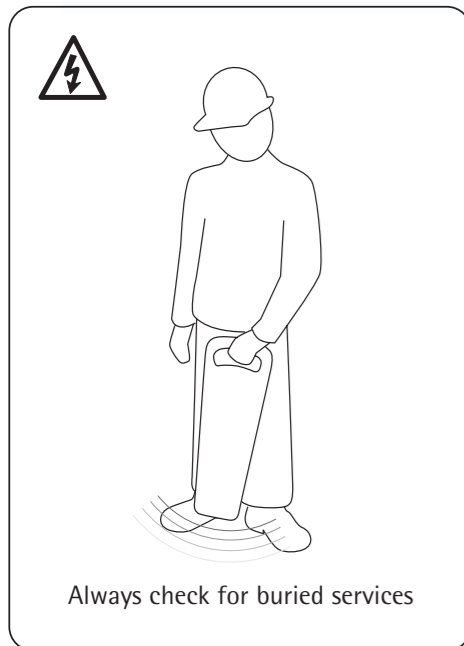

Rootfast® anchorage system



EA101



EA102



timber furniture kit for soft surfaces

- protect your timber furniture from thieves and vandals
- quick and easy installation
- avoid the mess of mixing concrete
- anchor driven 500mm below ground
- suitable for all outdoor timber furniture
- supplied with standard and tamper-proof screws

EA101 kit consists of 2No anchors, 2No brackets and 8No screws.

EA102 kit consists of above plus reusable installation tools.



bolt down kit for hard surfaces

EA103 kit consists of 2No expanding bolts, 2No brackets and 8No screws.

Rootfast® anchorage system

Rootfast® anchors and fittings

anchor ref	A1	A2	A3	A4	A5	A6	A7	A8
section (mm)	25 dia.	25 dia.	50 dia.	40x40	40x40	40x40	40x40	50x30
length (mm)	500	750	620	620	620	620	1040	1060
anchor weight (kg)	0.65	0.85	6.80	3.20	3.80	3.30	4.70	10.50
installation tool ref	T1	T2	T3	T4	T4	T4	T5	T6

- F1 heading
- F2 top strap
- F3 horizontal socket
- F4 vertical socket
- F5 seat socket
- F6 flange
- F7 'U' bolt
- F8 'J' bolt