

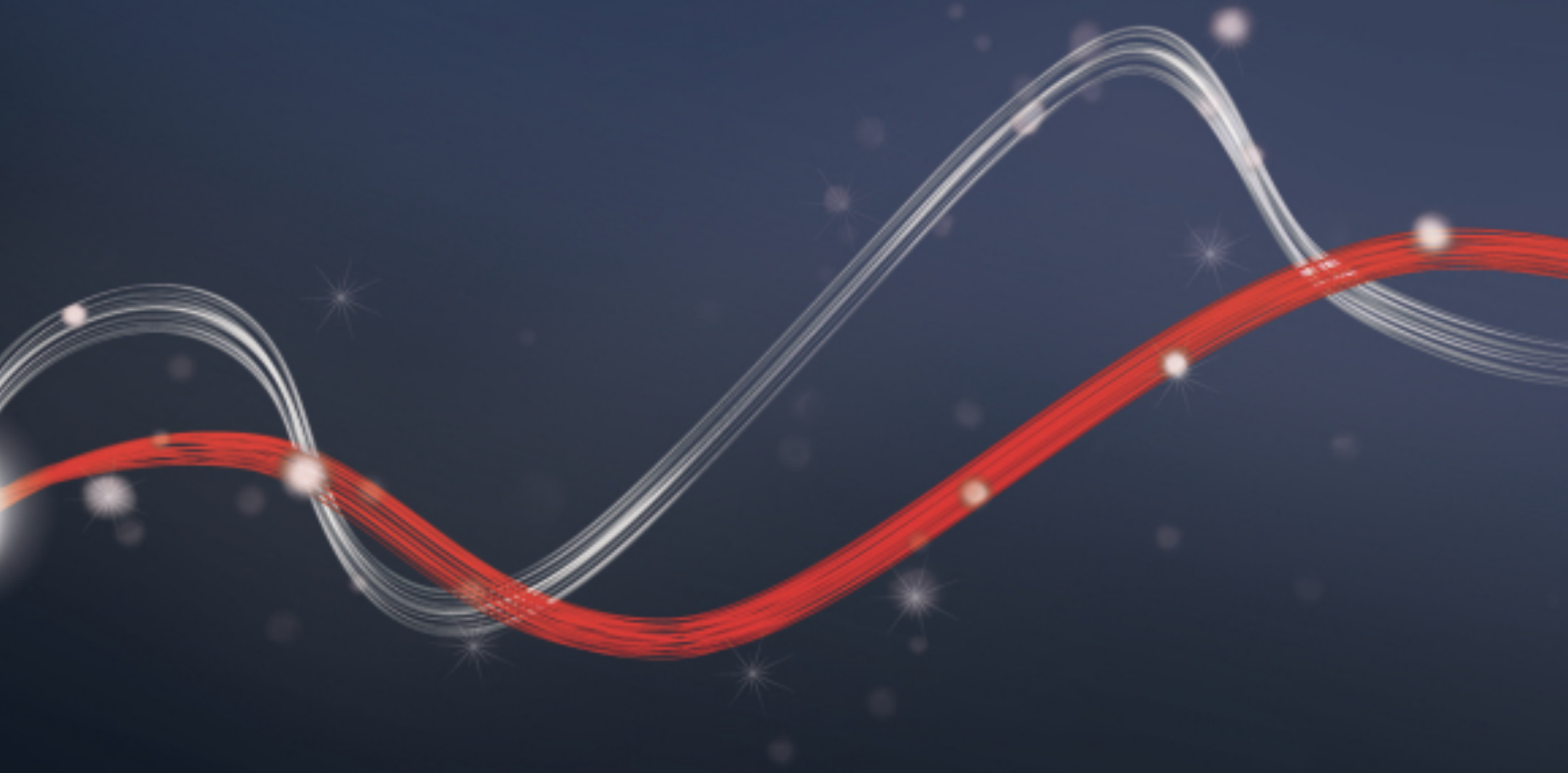

Be ahead



PILLAR B



• Product

• TECHNICAL FEATURES

• ACCESSORIES

• DISCOVER U-LINK



Anti-terrorist hydraulic bollard with incorporated hydraulic control unit. Suitable for protecting sensitive sites, thanks to the special “SD” version, which keeps the shaft raised in case of a power failure and with public installations where, in the standard version, the shaft lowers automatically with no power.

PILLAR B | | |

Code	Name	Description
P970092 00001	PILLAR B 275/600.6C L	HYDRAULIC bollard 230 V . . 600 mm with LED light cap and with adhesive strip H: 100 mm approved. The shaft lowers automatically in case of a power failure. . Hydraulic bollard 230 V, shaft height 600 mm and diameter 275. LED light cap and H adhesive strip: 100 mm approved. The shaft automatically lowers in case of a power failure. RAL 7015 painted steel version.
P970092 00002	PILLAR B 275/600.6C LI	HYDRAULIC bollard 230 V . . 600 mm with LED light cap and with adhesive strip H: 100 mm approved. The shaft lowers automatically in case of a power failure. . Hydraulic bollard 230 V, shaft height 600 mm and diameter 275. LED light cap and H adhesive strip: 100 mm approved. The shaft automatically lowers in case of a power failure. Stainless steel version.
P970092 00003	PILLAR B 275/600.6C L SD	HYDRAULIC bollard 230 V . . 600 mm with LED light cap and with adhesive strip H: 100 mm approved. The shaft stays raised in case of no power. . Hydraulic bollard 230 V, shaft height 600 mm and diameter 275. LED light cap and H adhesive strip: 100 mm approved. The shaft stays raised in case of a power failure. RAL 7015 painted steel version.
P970092 00004	PILLAR B 275/600.6C LI SD	HYDRAULIC bollard 230 V . . 600 mm with LED light cap and with adhesive strip H: 100 mm approved. The shaft stays raised in case of no power. . Hydraulic bollard 230 V, shaft height 600 mm and diameter 275. LED light cap and H adhesive strip: 100 mm approved. The shaft stays raised in case of a power failure. Stainless steel version.

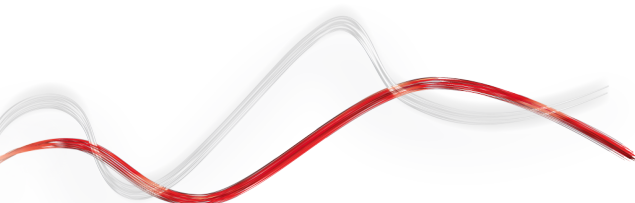

• Product

• TECHNICAL FEATURES

• ACCESSORIES

• DISCOVER U-LINK

PILLAR B

Code	Name	Description
P970093 00001	PILLAR B 275/800.6C L	HYDRAULIC bollard 230 V. . 800 mm. with LED light cap and with adhesive strip H: 100 mm approved. The shaft lowers automatically in case of a power failure. . Hydraulic bollard 230 V, shaft height 800 mm and diameter 275. LED light cap and H adhesive strip: 100 mm approved. The shaft automatically lowers in case of a power failure. RAL 7015 painted steel version.
P970093 00002	PILLAR B 275/800.6C LI	HYDRAULIC bollard 230 V. . 800 mm. with LED light cap and with adhesive strip H: 100 mm approved. The shaft lowers automatically in case of a power failure. . Hydraulic bollard 230 V, shaft height 800 mm and diameter 275. LED light cap and H adhesive strip: 100 mm approved. The shaft automatically lowers in case of a power failure. Stainless steel version.
P970093 00003	PILLAR B 275/800.6C L SD	HYDRAULIC bollard 230 V. . 800 mm. with LED light cap and with adhesive strip H: 100 mm approved. The shaft stays raised in case of a power failure. . Hydraulic bollard 230 V, shaft height 800 mm and diameter 275. LED light cap and H adhesive strip: 100 mm approved. The shaft stays raised in case of a power failure. RAL 7015 painted steel version.
P970093 00004	PILLAR B 275/800.6C LI SD	HYDRAULIC bollard 230 V. . 800 mm. with LED light cap and with adhesive strip H: 100 mm approved. The shaft stays raised in case of a power failure. . Hydraulic bollard 230 V, shaft height 800 mm and diameter 275. LED light cap and H adhesive strip: 100 mm approved. The shaft stays raised in case of a power failure. Stainless steel version.

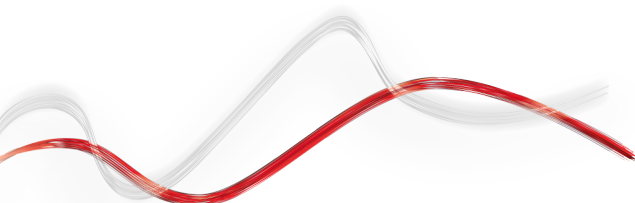

· Product

· TECHNICAL FEATURES

· ACCESSORIES

· DISCOVER U-LINK

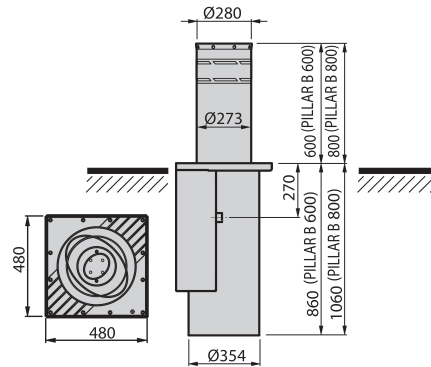

	PILLAR B 275/600.6C L	PILLAR B 275/600.6C LI	PILLAR B 275/600.6C L SD	PILLAR B 275/600.6C LI SD	PILLAR B 275/800.6C L	PILLAR B 275/800.6C LI	PILLAR B 275/800.6C L SD	PILLAR B 275/800.6C LI SD
Voltage	230 V							
Rod height	600 mm				800 mm			
Rod diameter	275							
Opening or closing time	5 sec.				6.5 sec.			
Operator type	hydraulic bollards							
Control unit	PERSEO CBD 230.P SD							
Type of limit switch	reed magnetic sensor							
Impact resistance	20000 J							
Break-in proof	250000 J							
Manual cycle	reversible in the absence of voltage	release key			reversible in the absence of voltage		release key	
Frequency of use	3000 Op/gg							
Environmental conditions	from -40 °C to 60 °C							
Protection rating	IP67							

· Product

· TECHNICAL FEATURES

· ACCESSORIES

· DISCOVER U-LINK

	Code	Name		Description
	D113812 00002	PERSEO CBE 230.P SD		Control unit with U-Link, receiver and incorporated heating circuit (to -40°C) for electro-mechanical and hydraulic bollards. Can manage up to 4 bollards at the same time (or up to 2 Xpass 1200)
	P800102	PILLAR ALARM		Magnetic anti-theft kit for PILLAR B hydraulic bollards. To be requested when ordering
	P800040	TPF		Foundation and anchor plate for TPF totem
	P800039	TL		Traffic lights and top covering for totem
	P800037	TBA		Bottom element for TBA totem. Top covering not included.
	P800038	TSU		Top element for TSU totem. Top covering not included.
	D113705	ACOUSTIC DETECTOR		Adjustable acoustic detector for sirens ACOUSTIC DETECTOR
	D113800	AXXEDO Q.BO SA		"All in one" stand-alone digital button panel with 125 kHz proximity reader and ambient light sensor. multitone buzzer. stores 400 different codes. integrated outputs Stand-alone keypad with 125 KHz proximity reader and two relays for the control of a gate and a courtesy light
	P121025	Q.BO PAD		Vandalproof outdoor digital button panel. Metal structure and s/steel buttons. Compatible with WIEGAND protocol, it ensures maximum system safety as it does not directly control gate opening.
	P121024	Q.BO TOUCH		Wireless digital touchpad with 433MHz rolling code operation. Manages up to 10 channels and 100 codes.
	P121022	Q.BO KEY WM		Key selector for outdoor use with double contact.
	P121023	Q.BO KEY WM AV		Vandalproof key selector with double contact, for outdoor use. Metal structure. Vandalproof key selector with metal structure.
	P111526	DESME A15		Pair of self-aligning photocells. Range 30 m. Power supply 24 V ac/dc. Pair of self-aligning photocells. Range 30 m. Power supply 24 V ac/dc.
	P111527	DESME A15 O		Pair of photocells adjustable 40 ° horizontally and 10 ° vertically. IR signal synchronised to prevent any risk of blinding. Range 30 m. Power supply 24 V ac/dc.
	P111538	ACV30		Vandal-proof protection for AKTA photocells

· Product

· TECHNICAL FEATURES

· ACCESSORIES

· DISCOVER U-LINK

	Code	Name		Description
	P111536	AKTA A30		Pair of photocells adjustable 180 ° horizontally and 20 ° vertically. Range 30 m. Power supply 24 V ac/dc.
	P111399	IT23		Connection interface for CELLULA RFL in accordance with EN12453 Standard
	P903004	CC50		Pair of aluminium posts for CELLULA 50 and CELLULA RFL photocells
	P111391	CELLULA RFL		Reflective photocell for external application (range 12 m) Power supply 24V ac/dc (requires S RFLP P111409)
	P903014	CM RFL		CELLULA RFL wall mounting support
	P111409	S RFLP		Reflector and support for wall mounting and mounting on CC post for CELLULA RFL
	P903013	CC RFL		CELLULA RFL and S RFLP mounting support on CC posts
	P111274	RME 1 BT		24Vac single channel metal object detector with installation base
	P111001 00003	RME 2		230Vac dual channel metal object detector Supplied with RME 2 installation base
	D110926 00001	SPIRA 2X1		Magnetic loop 2 x 1 m
	P903018	PHP		Pair of aluminium posts for THEA/DESME series photocells Height 522 mm
	P903026	PHP3		Pair of aluminium columns for Q.bo series selectors. Height 1038 mm
	P903019	PHP2		Pair of double aluminium posts for THEA/DESME series photocells. Height 1038 mm
	P903027	PHP4		Pair of aluminum columns of different heights, for Q.bo series selectors and DESME and THEA series photocells. Column for selector: height 1038 mm, column for photocells: height 552mm
	P903025	PHP ADA		Pair of adapters for the installation of AKTA photocells on PHP posts

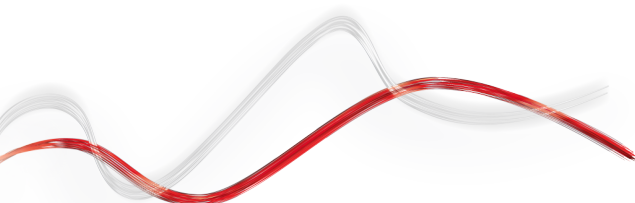









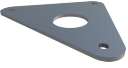





· Product

· TECHNICAL FEATURES

· ACCESSORIES

· DISCOVER U-LINK

	Code	Name	Description
	P903020	APL 	Pair of foundation plates for PHP posts
	D113256	COMPASS 485	Interface control unit for connection with a maximum of 2 compass slim . Number of cards managed: up to 6000 in stand alone .
	D110912	COMPASS - ISOCARD	ISO standard proximity badge
	D110914	COMPASS - RING	Key-ring transponder for access control
	D113704	COMPASS SLIM	Reader head with ip55 protection rating.
	D111904	MITTO B RCB02 R1	Transmitter with 2 channels. Range 50/100 m. Power supply 12 V with 1 battery type 23 A
	N999542	MITTO B RCB02 R3	Transmitter channels. Range . Power supply with 1 battery type 23 A. Pack of 100pcs numbered for block memorisation. Transmitter 2 channels. Range 50/100 m. Power supply 12 V with 1 battery type 23 A. Pack of 100pcs numbered for block memorisation.
	D111906	MITTO B RCB04 R1	Transmitter with 4 channels. Range 50/100 m. Power supply 12 V with 1 battery type 23 A
	N999543	MITTO B RCB04 R3	Transmitter channels. Range . Power supply with 1 battery type 23 A. Pack of 100pcs numbered for block memorisation. Transmitter 4 channels. Range 50/100 m. Power supply 12 V with 1 battery type 23 A. Pack of 100pcs numbered for block memorisation.
	D111888	KLEIO B RCA02 R1	Transmitter with 2 channels. Range 50/100 m. Power supply 12 V with 1 battery type 23 A
	D111890	KLEIO B RCA04 R1	Transmitter with 4 channels. Range 50/100 m. Power supply 12 V with 1 battery type 23 A
	D111905	MITTO B RCB02 R2 REPLAY	Copyable transmitter 2 channels. Range 50/100 m. Power supply 12 V with 1 battery type 23 A
	D111907	MITTO B RCB04 R2 REPLAY	Copyable transmitter 4 channels. Range 50/100 m. Power supply 12 V with 1 battery type 23 A
	D111945	MITTO B RCB04 R1 VINEYARD 	Transmitter 4 channels. Range 50/100 m. Power supply 12 V with 1 battery type 23 A. Colour: Vineyard Red

· Product

· TECHNICAL FEATURES

· ACCESSORIES

· DISCOVER U-LINK

	Code	Name	Description
	D111947	MITTO B RCB04 R1 CLEAR ICE new	Transmitter 4 channels. Range 50/100 m. Power supply 12 V with 1 battery type 23 A. Colour: Clear Ice White
	D111946	MITTO B RCB04 R1 SUNRISE new	Transmitter 4 channels. Range 50/100 m. Power supply 12 V with 1 battery type 23 A. Colour: Sunrise Yellow
	P121016	RB	4-channel wall-mounted radio control with rolling code
	D113674 00001	CLONIX 2E	CLONIX 2E 433 MHZ dual channel external receiver with rolling code (to be used if there is no CLONIX receiver in the system)
	D113718 00002	CLONIX 4 RTE	External 4-channel 433 MHz rolling code receiver. Power relay outputs (16A 230v)
	D113807 00002	CLONIX 2E AC U-LINK 230 new	433MHz 2ch external receiver 433Mhz external receiver with 2 outputs with NO contact. Compatible with U-LINK protocol (with 3 connection slots). Power supply 230V, 2048-position memory
	D113808 00003	CLONIX UNI AC U-LINK 230V new	433MHz 3ch external receiver U-LINK 433Mhz external receiver with 3 outputs: 2 with NO contact and one NO/NC configurable. Compatible with U-LINK protocol (with 3 connection slots). Power supply 230V, 2048-position memory
	D113670 00002	RTD 2048	Four-channel rolling code receiver with 2048 codes and built-in programming display. 230Vac power supply, radio command block programming
	D113746 00003	GSM RECEIVER	GSM receiver. Enables the operation of an automation system with a free phone call
	D113748 00002	RADIUS B LTA 230 R1	Flashing light with incorporated antenna for motors with power supply 230 V.
	P123025	B 00 R02	Wall mounting for B LTA series flashing beacons
	P123026	B 00 R01	Metal guard for B LTA
	D111713 00001	MOP	Accessory for adding an output channel to RTD
	D831081	CMS	Sign



PILLAR B



· Product

· TECHNICAL FEATURES

· **ACCESSORIES**

· DISCOVER U-LINK

	Code	Name	Description
	D121458	TRAFFIC LIGHT	Traffic lights with two red/green lights

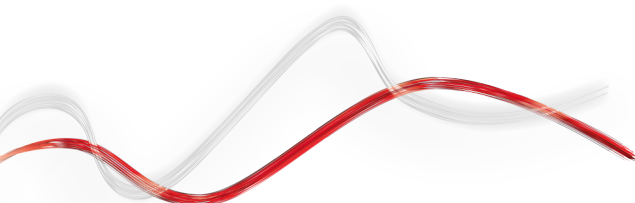

· Product

· TECHNICAL FEATURES

· ACCESSORIES

· DISCOVER U-LINK

What is U-Link?

The innovative technology that gives you new power

An exclusive Bft innovation: U-Link (Universal Link) is an exclusive Bft platform that allows the creation of technological ecosystems. In Home Automation Access, it allows communication with all the home access automation devices of any brand. So you save time and can control everything with ease, without any worries.

It is intuitive

Easy to install and use

It is scalable

Allows an unlimited number of devices to be added

It is flexible

Allows the creation of groups of interconnected products

It is practical

Works with or without a web connection

It is functional

Parameters can be controlled remotely via dedicated applications

· Product

· TECHNICAL FEATURES

· ACCESSORIES

· DISCOVER U-LINK

All in one scheme: discover this amazing technology

A unique platform **allowing the creation of technological ecosystems** offering a wide range of solutions for different sectors.

Thanks to the B-Eba cards and the Clonix U-Link receiver, this proprietary platform featured by Bft products adapts to any protocol and access automation product (even BFT, non-native U-Link or non-BFT products), and is used in various sectors. Each device thus becomes smart and can be interconnected with other systems, thanks to a language that becomes universal.

U-Base 2



Software to install and easily and comfortably carry out maintenance and identify any malfunction of U-link compatible operators.

U-SDK



U-SDK is the innovative application that can make Bft automation systems compatible and easily integrated with a BMS network for the supervision of buildings.



Magistro

An innovative and easy to install system for easily managing all home automation systems.



U-Control

U-Control is the application that helps the quick and easy integration of BFT automation systems in large building management systems.



Blue-Entry

Technology abreast of the times and attentive to daily needs: thanks to the use of U-link the house gate can now be opened with just your smartphone.



Clonix U-Link

Allows the connection of non-native U-Link products or non-Bft products to U-Link systems.

Bft operators, non-native U-Link products or a product belonging to other brands: can they be connected to U-Link? Yes, thanks to the Clonix receivers. Accessories that know no limits.

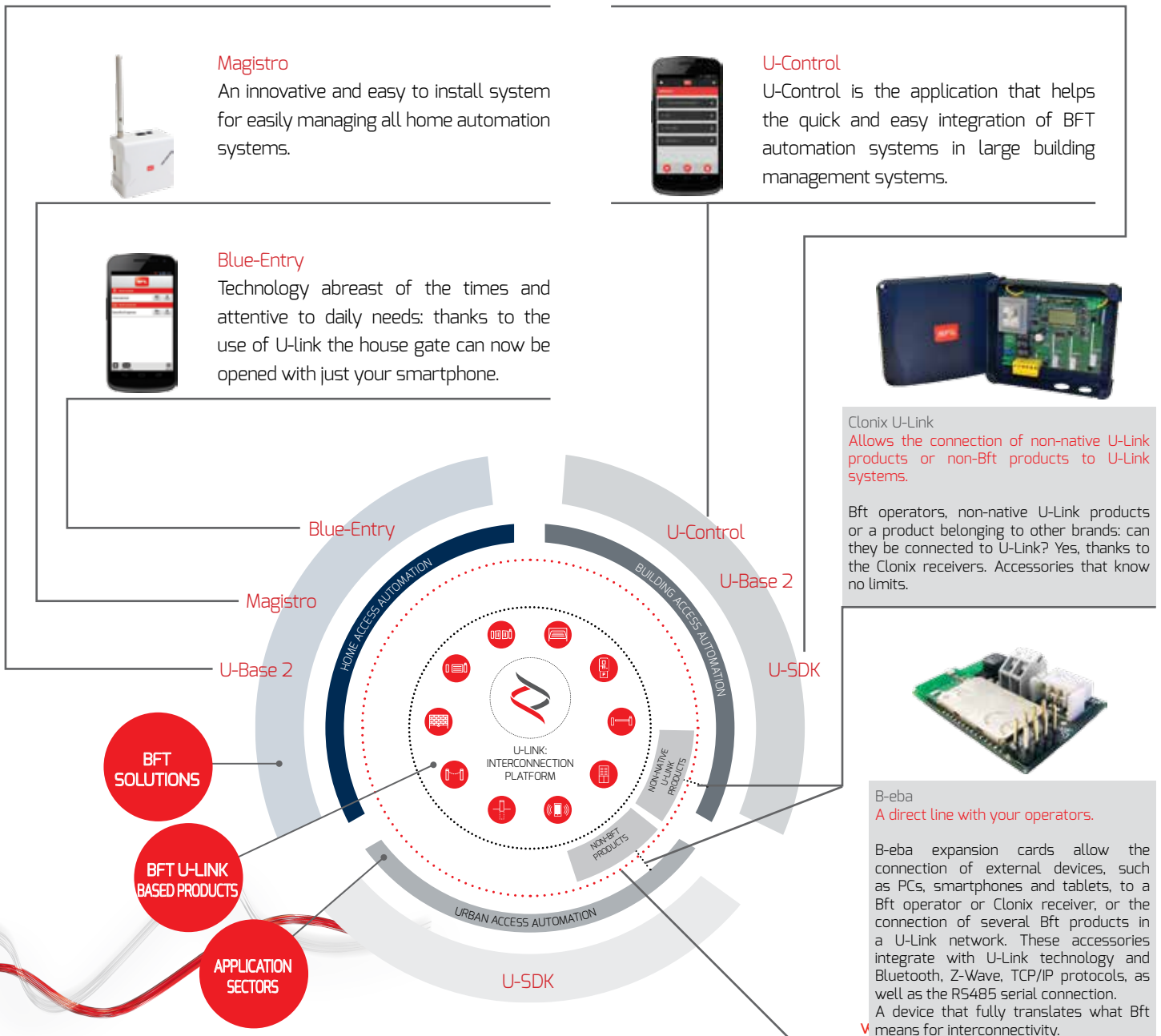

B-Eba

A direct line with your operators.

B-Eba expansion cards allow the connection of external devices, such as PCs, smartphones and tablets, to a Bft operator or Clonix receiver, or the connection of several Bft products in a U-Link network. These accessories integrate with U-Link technology and Bluetooth, Z-Wave, TCP/IP protocols, as well as the RS485 serial connection.

A device that fully translates what Bft means for interconnectivity.



INFORMATION REGARDING THE PROTECTION OF THE INDUSTRIAL AND INTELLECTUAL PROPERTY RIGHTS OF BFT. BFT S.p.A. protects its industrial property by depositing trademarks, patents, models and designs. The intellectual property of BFT S.p.A. is protected by copyright law. BFT S.p.A. also protects its know-how by taking measures to protect the technical and commercial information inherent in its company and products. All the products in this catalogue are ORIGINAL BFT MODELS and only BFT S.p.A is authorised to produce them and market them anywhere in the world. All the commercial names in this catalogue are owned by BFT S.p.A., and only BFT S.p.A. is authorised to use them in relation to the corresponding merchandise category. FALSIFIERS WILL BE PROCEEDED AGAINST IN ACCORDANCE WITH BOTH CIVIL AND CRIMINAL LAW. THESE CONDITIONS NOT ONLY GUARANTEE THE INTELLECTUAL PROPERTY RIGHTS OF BFT, BUT ALSO PROTECT CUSTOMERS BY GUARANTEEING THAT THE PRODUCTS THEY ARE PURCHASING ARE ORIGINAL BFT PRODUCTS RESULTING FROM STUDIES AND DESIGNS WITHIN THE BFT COMPANY.