

# INFORMATION SIGNS

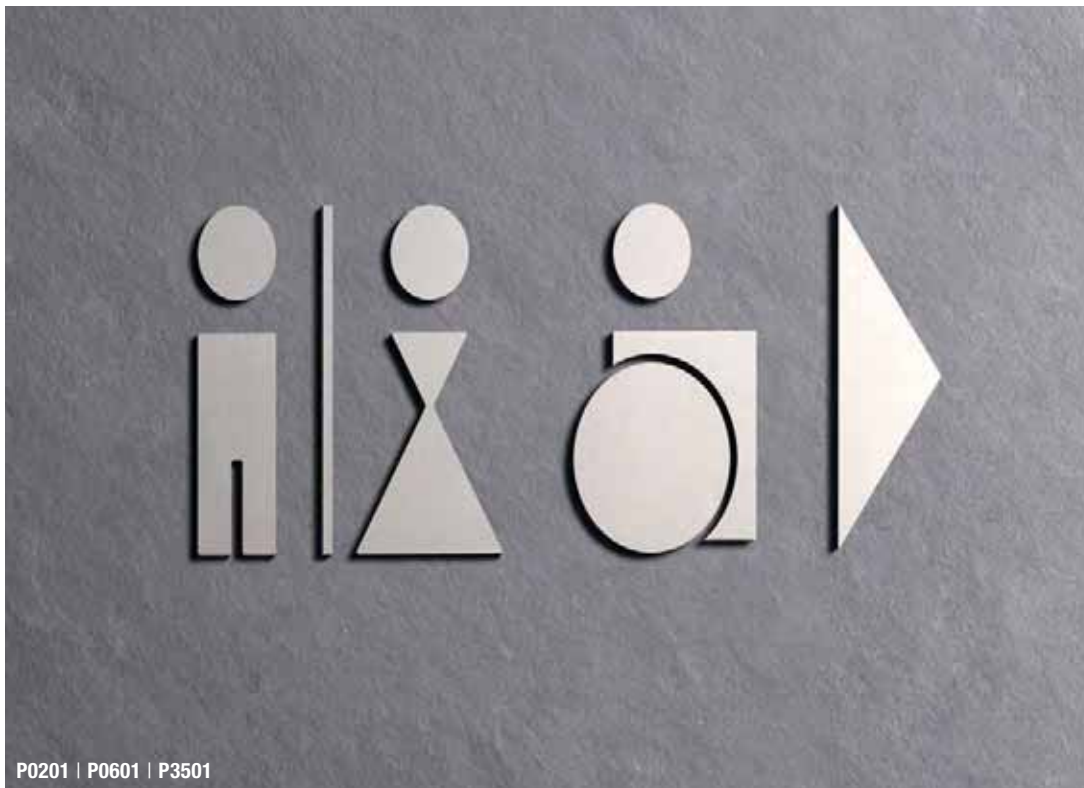



P0201 | P0601 | P3501



product  
design  
award

1998

iF Product Design Award 1998  
International Forum Design, Hannover



Good Design Award 1999  
JIDPO/G-Mark, Japan



reddot design award  
winner 2000

reddot design award 2000  
Design-Zentrum Nordrhein-Westfalen

Design: Andreas Winkler

## PICTOGRAMS

Stainless steel, vertically matt brushed, lasered and finely machined. Self-adhesive, strong adhesion (Pure acrylate), material thickness 2 mm, dimensions in H x W. Design: Andreas Winkler / Thorsten Wohner



P0101 – 110 x 95 mm



P0201 – 110 x 119 mm



P0301 –  
110 x 30 mm



P0401 –  
110 x 55 mm



P0501 – 110 x 70 mm



P0601 – 110 x 70 mm



P0701 – 95 x 93 mm



P0801 – 95 x 108 mm



P0901 – 95 x 30 mm



P1001 – 95 x 51 mm



P1101 – 80 x 80 mm



P2501 – 103 x 103 mm



P2601 – 118 x 80 mm



P2701 – 105 x 134 mm

Available in custom sizes

Appropriate captions  
like H, D, WC, see p. 13

With regard to theft protection in  
public areas, we recommend  
attachment using hot glue or  
silicone.

Brushed on one side.

# PICTOGRAMS

Stainless steel, vertically matt brushed, lasered and finely machined. Self-adhesive, strongly adhesive (pure acrylate), material thickness 2 mm, dimensions in H x W. Design: Andreas Winkler / Thorsten Wohner



**P2001** – 150x35 mm



**P2101** – 150x55 mm



**P2201** – 55x50 mm



**P1301** – 110x65 mm



**P1401** – 110x69 mm



**P1901** – 44x90 mm



**P1701** –  
95x60 mm



**P1801** –  
95x75 mm



**P2301** –  
135x45 mm



**P2401** –  
135x55 mm



**P2901** –  
125x125 mm



**P3001** –  
67x100 mm



**P3701** –  
92x85 mm



**P3201** – 79x117 mm

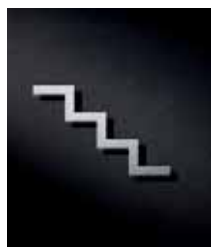

**P3101** – 79x117 mm

Ideal for combining with other pictograms



**P4101** – 112x91 mm



**P3801** – 110x96 mm



**P3301** – 94x130 mm



**P3401** – 84x150 mm



**P3501**  
110x30 mm

Ideal for combination  
with other pictograms.



**P3501** rotated  
110x30 mm

Also available as:

**PPF25** – Arrow 25x9 mm

**PPF40** – Arrow 40x14 mm

**PPF70** – Arrow 70x25 mm

Available in  
custom sizes.

Suitable  
captions like  
H, D, WC,  
see p. 13

With regard to  
theft protection in  
public areas,  
we recommend  
attachment using  
hot glue or silicone.  
oder Siliikon  
Brushed on one side.

## PICTOGRAMS EXAMPLE COMBINATIONS





## PICTOGRAMS | INDIVIDUAL PRODUCTION

PHOS pictograms have received three international design awards. We offer a complete pictogram series with clear and unambiguous statements. On request, we design and manufacture individual symbols as well as individual dimensions and material thicknesses. All pictograms are processed by hand. Stainless steel, vertically matt brushed, lasered and finely machined. Self-adhesive, strongly adhesive (pure acrylate).

Regarding theft protection in public areas we recommend fixing with hot glue or silicone. Brushed on one side.

Classic pictograms of the public area:



Individual pictograms - design and production according to template or draft:





## PICTOGRAMS | SOFT EDGE FRAME

### EXTENSION ARTICLE FOR PICTOGRAMS

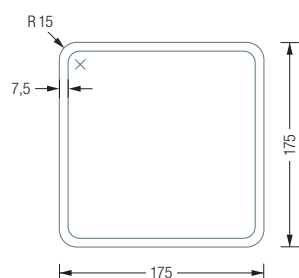

#### PR175X175

Square frame for pictograms in soft-edge design with rounded corners. Height x Width: 175 x 175mm. Stainless steel, vertically matt brushed, lasered and finely machined. Self-adhesive, strongly adhesive (pure acrylate), material thickness 2 mm.

Also available as:

**PR175X250** – rectangular frame with soft edge design, height x width: 175 x 250 mm.

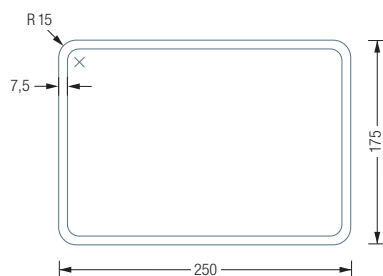

The frames are universal additional elements and can be used in combination with all pictograms.

With regard to theft protection in public areas, we recommend attachment using hot glue or silicone.

Brushed on one side.



PS0203

## PICTOGRAM SIGNS

Stainless steel, vertically matt brushed, lasered and finely machined. Self-adhesive, strongly adhesive (pure acrylate), material thickness 2 mm, height x width: 160 x 160 mm. Design: Andreas Winkler / Thorsten Wohner. For optional mounting options and background film, see p. 18.

Custom sizes available.  
 Matching signs with WC lettering and directional arrows see p. 10  
 With regard to theft protection in public areas, we recommend attachment using hot glue or silicone.  
 Brushed on one side.



PS0301



PS0401



PS0101



PS0201



PS0701



PS0801



PS0901



PS1001



PS0501



PS0601



PS2501



PS2601



PS2701



PS4002

Height x width: 100x100 mm

# PICTOGRAM SIGNS

Stainless steel, vertically matt brushed, lasered and finely machined. Self-adhesive, strongly adhesive (pure acrylate), material thickness 2 mm, height x width: 160 x 160 mm. Design: Andreas Winkler / Thorsten Wohner For optional mounting options and background film, see p. 18.

Available in custom sizes.

With regard to theft protection in public areas, we recommend attachment using hot glue or silicone.

Brushed on one side.



PS1101



PS1301



PS1401



PS1501



PS1601



PS1901



PS1701



PS1801



PS2001



PS2101



PS2201



PS3801



PS3701



PS2301



PS2401



PS3901



PS2901



PS3001



PS3301



PS3401



PS3201

Ideal for combining with other pictograms.

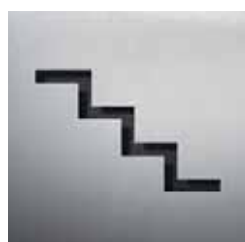

PS3101

Ideal for combining with other pictograms.



PS3501

Ideal for combining with other pictograms.

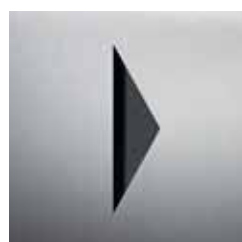

PS3501 – TURNED



PS4101

# PICTOGRAM SIGNS

Stainless steel, vertically matt brushed, lasered and finely machined. Self-adhesive, strongly adhesive (pure acrylate), material thickness 2 mm. For optional mounting options and background film, see p. 18.



**PS0302** – 160 x 160 mm



**PS0303** – 160 x 160 mm



**PS0402** – 160 x 160 mm



**PS0403** – 160 x 160 mm

Custom sizes available.

Appropriate signs  
WC lettering and directional  
arrows see p. 10

With regard to theft protection  
in public areas, we recommend  
attachment using hot glue or  
silicone.

Brushed on one side.



**PS0502** – 160 x 160 mm



**PS0602** – 160 x 160 mm



**PS0202** – 160 x 235 mm



**PS0203** – 160 x 235 mm

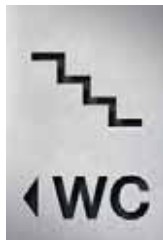

**PS3105** –  
235 x 160 mm



**PS3204** –  
235 x 160 mm



**PS0504** –  
235 x 160 mm



**PS0604** –  
235 x 160 mm



**PS0206** –  
235 x 160 mm



**PS0207** –  
235 x 160 mm



**PS0210** – 160 x 320 mm



**PS0211** – 160 x 320 mm



**PS0217** – 160 x 320 mm



**PS0214** – 160 x 320 mm



**PS0219** –  
320 x 160 mm



**PS0220** –  
320 x 160 mm



**PS0213** – 160 x 320 mm



**PS0212** – 160 x 320 mm





## PICTOGRAM SIGNS | INDIVIDUAL PRODUCTION

In addition to our pictograms, our pictogram signs are among our most successful elements. On request, we design and manufacture individual symbols as well as individual dimensions and material thicknesses. Stainless steel, vertically matt brushed, lasered and finely machined. Self-adhesive, strongly adhesive (pure acrylate). Material thickness 2 mm.

As an option, we offer several attachment variants for our pictogram signs. It can be mounted "floating" on the wall with a wall attachment, or with spacers as a "flag" perpendicular to the wall or down from the ceiling - see p. 17. Both sides of all free-hanging signs are sanded to the same surface quality.

Classic pictogram signs of the public area:



With regard to theft protection in public areas, we recommend attachment using hot glue or silicone.

Individual pictogram signs - design and production according to template or draft:





BS0104 | FLAG ASSEMBLY BFFDM

## CAPTION | SIGNS

Stainless steel, vertically matt brushed, lasered and finely machined. Self-adhesive, strongly adhesive (pure acrylate), material thickness 2 mm, font: Helvetica Neue LT Medium. Size in H x W.

For optional mounting options and background film, see p. 18.

Custom sizes available.

Use of individual fonts according to specifications.

With regard to theft protection in public areas, we recommend attachment using hot glue or silicone.

Brushed on one side.



BS0101 – 160x160 mm



BS0103 – 160x235 mm



BS0104 – 160x235 mm



BS0105 – 160x235 mm



BS0106 – 160x235 mm



BS0201 – 160x160 mm

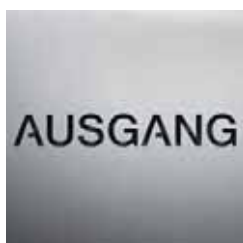

BS0301 – 160x160 mm



BS0401 – 160x160 mm



BS0802 –  
100x100 mm

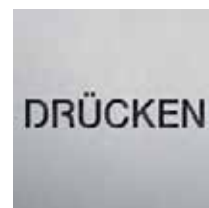

BS0902 –  
100x100 mm



BS0501 – 160x160 mm



BS0601 – 160x160 mm



BS0701 – 160x160 mm

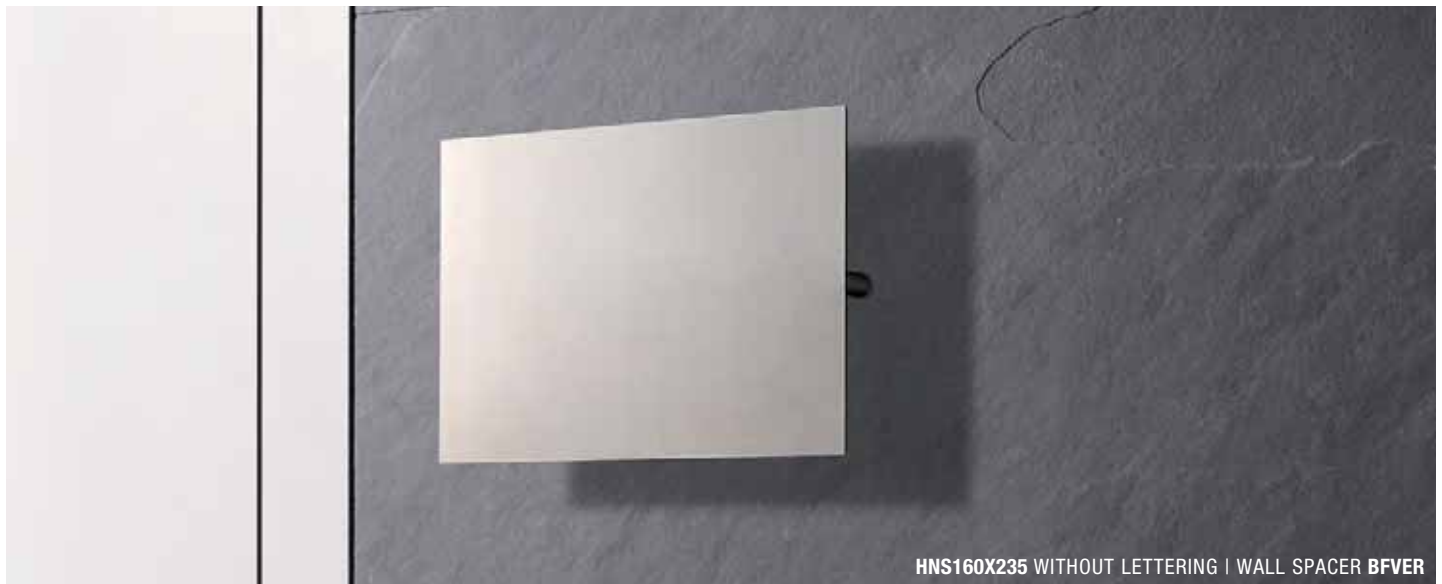

HNS160X235 WITHOUT LETTERING | WALL SPACER BFVER

Custom sizes available.

Use of individual fonts according to specifications.

With regard to theft protection in public areas, we recommend attachment using hot glue or silicone.

Brushed on one side.

## LABELS CUSTOM SIGNS

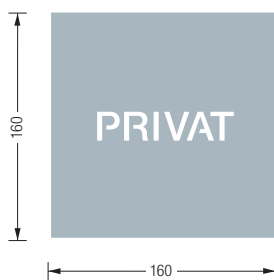

### HWS160X160

Lettering plate with individual lettering. Solid stainless steel, vertically matt brushed, lasered and finely machined. Self-adhesive, strongly adhesive (pure acrylate). Plate with a material thickness of 2 mm with custom lettering. Height x Width: 160 x 160mm. For optional mounting options and background film, see p. 18.

Also available as:

### HWS160X235 – Height x Width: 160 x 235 mm.

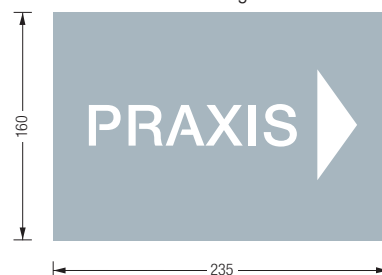



Optional version, please specify when ordering.

For optional mounting options and background foil, see p. 18

Custom sizes available.

With regard to theft protection in public areas, we recommend attachment using hot glue or silicone.

Brushed on one side.

## SIGNS | SOFT EDGE DESIGN

### APSED160X160

Optional version (surcharge item): Pictogram sign or information sign in a square soft-edge design with rounded corners. Height x Width: 160 x 160mm. Stainless steel, vertically matt brushed, lasered and finely machined.

Self-adhesive, strongly adhesive (pure acrylate), material thickness 2 mm

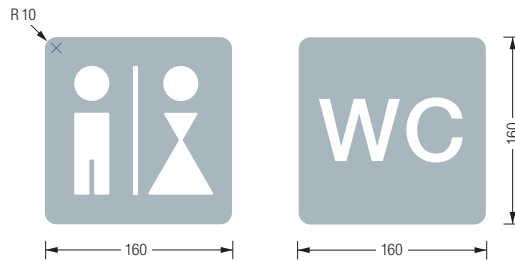

Also available as:

**APSED160X235** – in rectangular soft-edge design, height x width: 160 x 235 mm.

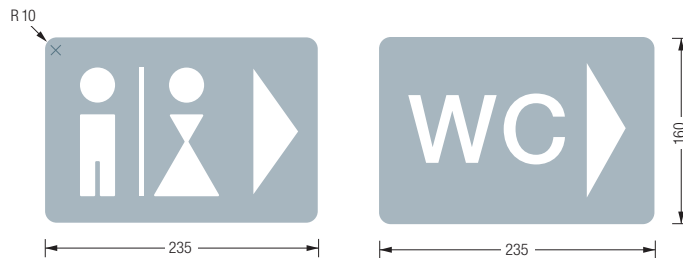



## LABELS

Custom sizes available.

Font Helvetica Neue Medium – Use of individual fonts according to specifications.

With regard to theft protection in public areas, we recommend attachment using hot glue or silicone.

Brushed on one side.



### FONT-25

Cap height 25 mm. Solid stainless steel, vertically matt brushed, lasered. Self-adhesive, strongly adhesive (pure acrylate), material thickness 2 mm. Ideal for combining with pictograms, see p. 2 f.

Also available as::

**FONT-35** – Cap height 35 mm.

**FONT-40** – Cap height 40 mm.

**FONT-60** – Cap height 60 mm.

**FONT-100** – Cap height 100 mm.

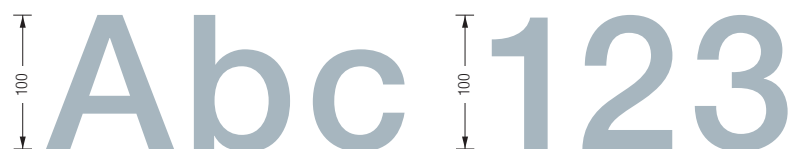





## HOUSE NUMBERS

### HN140

Height 140mm. Solid stainless steel, vertically matt brushed, lasered. Self-adhesive, strongly adhesive (pure acrylate), material thickness 4 mm. For optional mounting options, see p. 17.

Also available as:

**HN160** – Height 160 mm.

**HN200** – Height 200 mm.

140  
123 Abc

160  
123 Abc

200  
123 Abc

Custom sizes available.

Font Helvetica Neue Medium – Use of individual fonts according to specifications.

With regard to theft protection in public areas, we recommend attachment using hot glue or silicone.

Brushed on one side.



Custom sizes available Font

Helvetica Neue Medium  
– Use of individual fonts  
according to specifications

With regard to theft protection in  
public areas, we recommend  
attachment using hot glue or  
silicone.

Brushed on one side.

## HOUSE NUMBERS | SIGNS

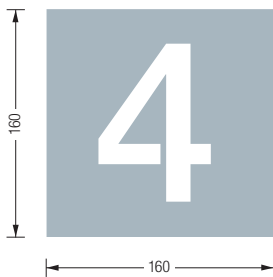

### HNS160X160

House number sign, height x width: 160 x 160 mm. Solid stainless steel, vertically matt brushed, lasered and finely machined. Self-adhesive, strong adhesion (pure acrylate). Sign in material thickness 2 mm with customized lettering. For optional mounting options and background film, see p. 18.

Also available as:

**HNS160X235** – Height x Width: 160 x 235 mm.

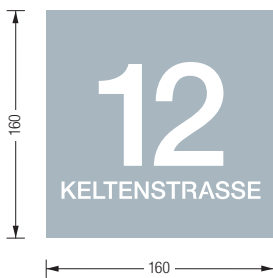



Including mounting material

Signs and inscriptions are equipped according to the desired fastening variant.

## MOUNTING VARIANTS SIGNS AND LABELS

### BFSS

Wall mounting set consisting of two strikers and M5 threaded sleeves attached to the rear. For direct mounting of signs and free-standing signs. Including, optionally usable wall spacers\*, Ø12 mm, length 12 mm. Solid stainless steel, hand-polished.

Installation example house number plate:

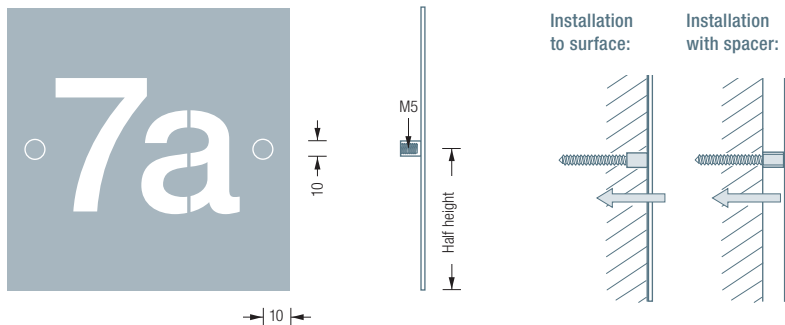

BFSS INSTALLATION TO SURFACE | HN140



BFSS MOUNTED WITH SPACER | HN140

### BFVER

Bracket set consisting of two wall mounts Ø 12 mm, length 25 mm. For concealed mounting of signs and free-standing signs via M6 thread. Rear screw connection possible. Cap height of 10 cm required for letters and numbers. Solid stainless steel, hand-polished.

Installation example house number plate:

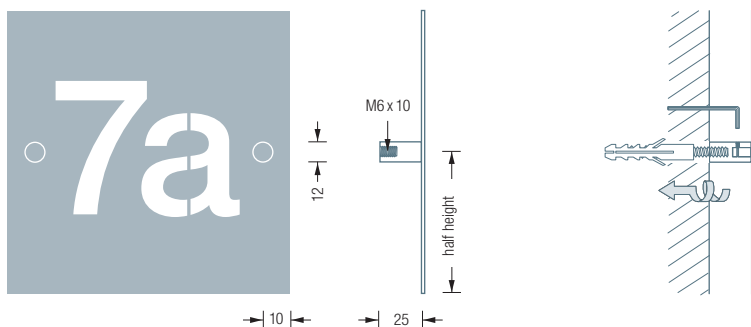

BFVER SCREWED WITH WALL SPACING | HN140

\* Material: PE (polyethylene), matt black.  
High chemical resistance, good sliding properties.

# MOUNTING VARIANTS

## SIGNS AND INSCRIPTION

### BFFDM – FLAG / CEILING MOUNTED

Sign holder set consisting of two spacers. Installation by clamping the pictogram/label. Solid stainless steel, hand-polished.

Including  
Mounting Material

Flag installation example WC sign:

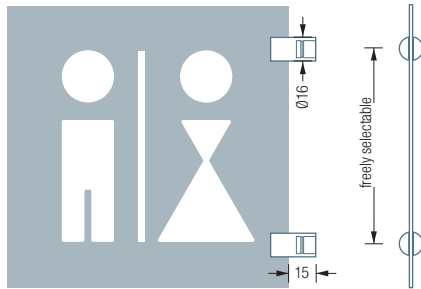

Flag mounting:

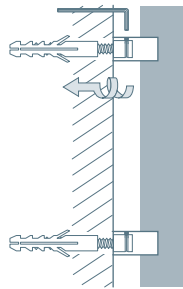

Ceiling mounting example toilet sign:

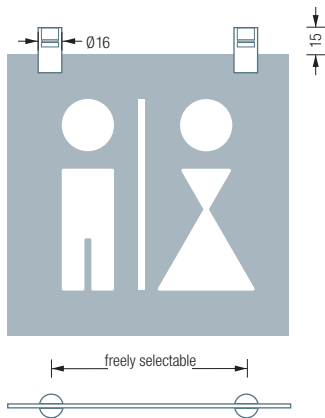

Ceiling mounting:

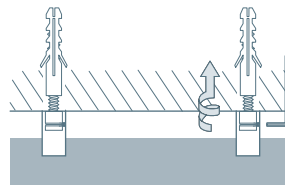

BFFDM FLAG ASSEMBLY | KFS

BFFDM CEILING MOUNTING | KFS

### APPBS

Optional variant of pictogram / lettering signs made of stainless steel matt brushed on both sides. Recommended when attaching the signs for two-sided visibility.

### KFS

Background plastic film, matt black, to be glued on the back on pictogram / label plates. Weatherproof and colourfast. Already attached at the factory.





CLOAKROOM SOLUTIONS LTD  
info@cloakroomsolutions.co.uk  
020 3011 1014  
cloakroomsolutions.co.uk