

# SHOE RACKS



PHOS 1

**CLOAKROOM**  
SOLUTIONS



Also available with oak wood shelf, see page 23.

Optionally, the shoe racks can be equipped with floor castors, see page 33.

## SHOE RACK

High-quality shoe racks made of stainless steel, satin finished. Individually positionable shelves (where the top shelf is a fixed element). With height-adjustable feet to compensate for uneven floors. The clear, timeless and reserved design can be combined with any interior and is a long-lasting companion. In combination with the PHOS wardrobes, there are many design options. Available in various standard heights and widths.

Shoe racks with two levels, total height 30 cm.  
Lower level can be positioned individually.

<b>SR600-2</b>	Overall width 62 cm.	<b>SR900-2</b>	Overall width 92 cm.
<b>SR700-2</b>	Overall width 72 cm.	<b>SR1000-2</b>	Overall width 102 cm.
<b>SR800-2</b>	Overall width 82 cm.		

Shoe racks with three levels, total height 50 cm.  
Middle and lower levels can be positioned individually

<b>SR300-3</b>	Overall width 32 cm.	<b>SR700-3</b>	Overall width 72 cm.
<b>SR400-3</b>	Overall width 42 cm.	<b>SR800-3</b>	Overall width 82 cm.
<b>SR500-3</b>	Overall width 52 cm.	<b>SR900-3</b>	Overall width 92 cm.
<b>SR600-3</b>	Overall width 62 cm.	<b>SR1000-3</b>	Overall width 102 cm.

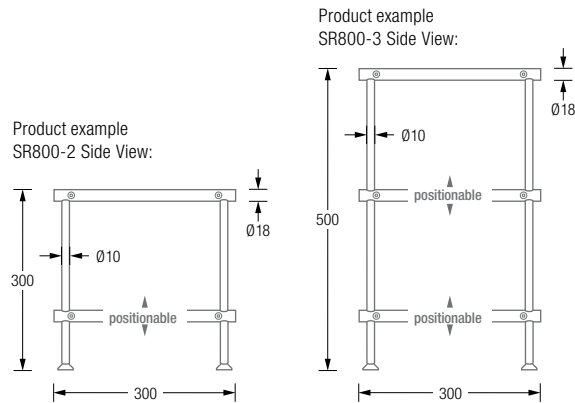

Product example SR800-2 / -3 Plan View:

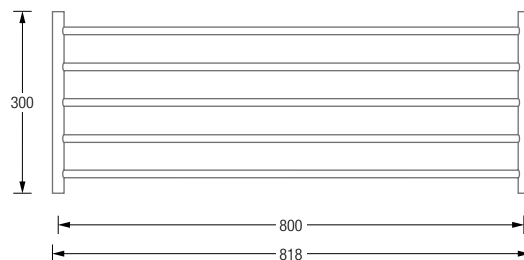



Custom sizes available.

Also available with oak wood shelf, see page 25.

Optionally, the shoe racks can be equipped with floor castors, see page 33.

## SHOE RACK

High-quality shoe racks made of stainless steel, satin finished. Individually positionable shelves (where the top shelf is a fixed element). With height-adjustable feet to compensate for uneven floors. The clear, timeless and reserved design can be combined with any interior and is a long-lasting companion.

In combination with the PHOS wardrobes, there are many design options. Available in various standard heights and widths. From a width of more than one meter, an intermediate carrier is integrated.

Shoe racks with two levels, total height 30 cm. Lower Level can be positioned individually.

**SR1200-2** Overall width 122 cm.

**SR1400-2** Overall width 142 cm.

Shoe racks with three levels, total height 50 cm. Middle and lower levels can be positioned individually.

**SR1200-3** Overall width 122 cm.

**SR1400-3** Overall width 142 cm.

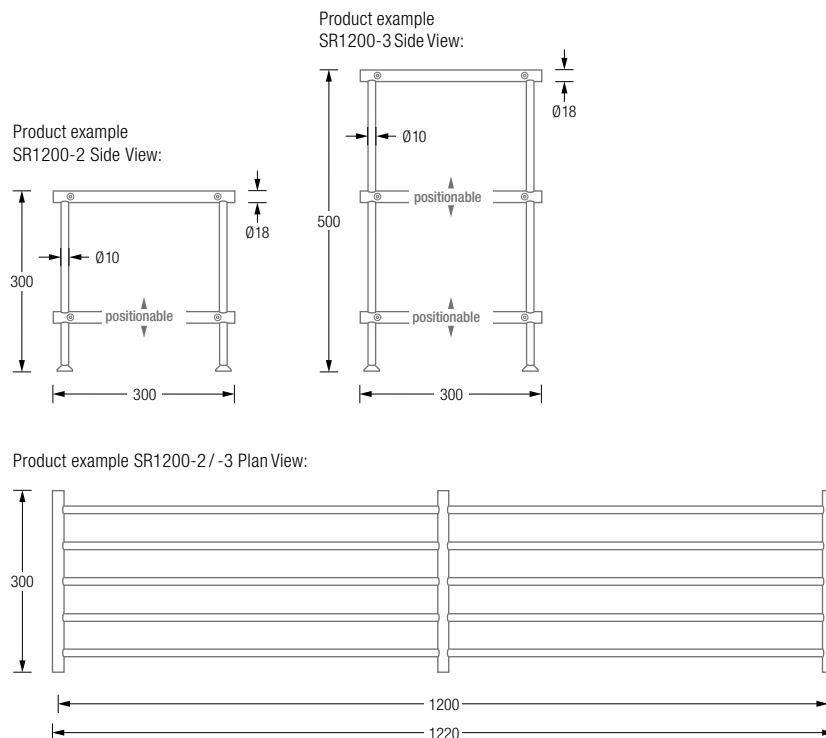



## SHOE RACK

High-quality shoe racks made of stainless steel, satin finished. Individually positionable shelves (where the top shelf is a fixed element). With height-adjustable feet to compensate for uneven floors. The clear, timeless and reserved design can be combined with any interior and is a long-lasting companion.

In combination with the PHOS wardrobes, there are many design options. Available in various standard heights and widths.

Shoe racks with four levels, total height 70 cm. Three lower levels can be positioned individually.

<b>SR300-4</b>	Overall width 32 cm.
<b>SR400-4</b>	Overall width 42 cm.
<b>SR500-4</b>	Overall width 52 cm.
<b>SR600-4</b>	Overall width 62 cm.
<b>SR700-4</b>	Overall width 72 cm.
<b>SR800-4</b>	Overall width 82 cm.
<b>SR900-4</b>	Overall width 92 cm.
<b>SR1000-4</b>	Overall width 102 cm.

Shoe racks with five levels, total height 90 cm. Four lower levels can be positioned individually.

<b>SR300-5</b>	Overall width 32 cm.
<b>SR400-5</b>	Overall width 42 cm.
<b>SR500-5</b>	Overall width 52 cm.
<b>SR600-5</b>	Overall width 62 cm.
<b>SR700-5</b>	Overall width 72 cm.
<b>SR800-5</b>	Overall width 82 cm.
<b>SR900-5</b>	Overall width 92 cm.
<b>SR1000-5</b>	Overall width 102 cm.

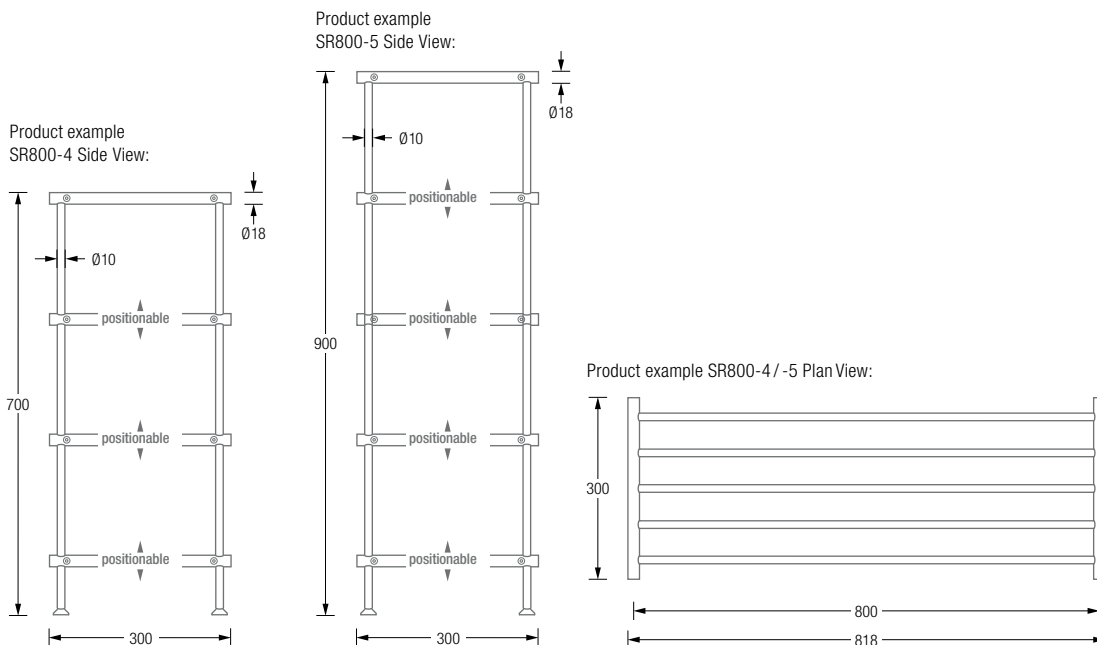







# SHOE RACK

High-quality shoe racks made of stainless steel, satin finished. Individually positionable shelves (where the top shelf is a fixed element). With height-adjustable feet to compensate for uneven floors. The clear, timeless and reserved design can be combined with any interior and is a long-lasting companion. In combination with the PHOS wardrobes, there are many design options. Available in various standard heights and widths. From a width of more than one meter, an intermediate carrier is integrated.

Shoe racks with four levels, total height 70 cm.  
Three lower levels can be positioned individually.

- SR1200-4** Overall width 122 cm.  
**SR1400-4** Overall width 142 cm.

Shoe racks with five levels, total height 90 cm.  
Four lower levels can be positioned individually.

- SR1200-5** Overall width 122 cm.  
**SR1400-5** Overall width 142 cm.

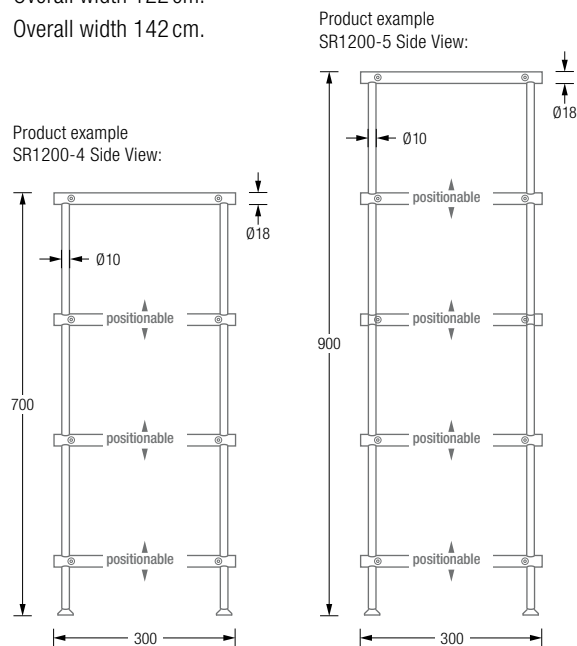

Product example SR1200-4 / -5 Plan View:

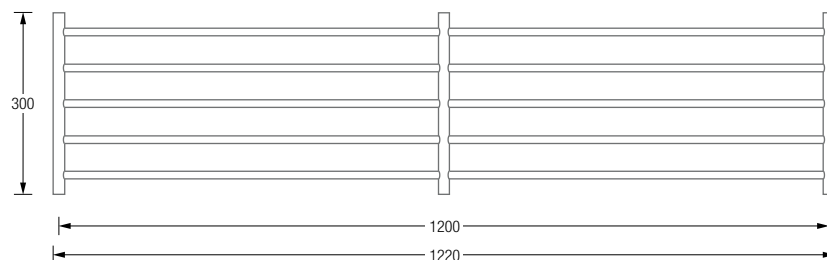







SR700-2W

Custom sizes available.

## SHOE RACK FOR WALL MOUNTING

Shoe racks made of silky matt polished stainless steel for wall mounting. Simple and timeless in design, the rock-solid shoe racks are also used in narrow corridors or entrance areas as a reliable helper and can be ideally combined with our wall wardrobes. With two levels. Simple assembly, with four attachment points for stable wall screwing. Available in different widths.

- SR600-2W** Overall width 62 cm.
- SR700-2W** Overall width 72 cm.
- SR800-2W** Overall width 82 cm.
- SR900-2W** Overall width 92 cm.
- SR1000-2W** Overall width 102 cm.

Product example SR800-2W Side View:

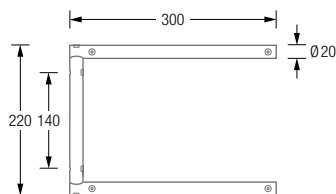

Product example SR800-2W Plan View:

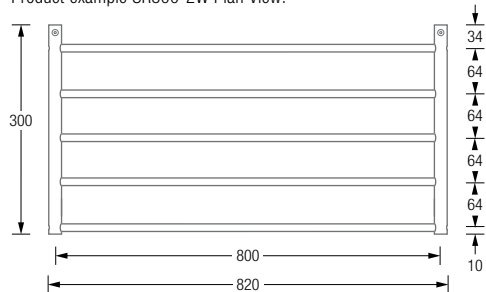





SR1400-2W

## SHOE RACK FOR WALL MOUNTING

Shoe racks made of silky matt polished stainless steel for wall mounting. Simple and timeless in design, the rock-solid shoe racks are also used in narrow corridors or entrance areas as a reliable helper and can be ideally combined with our wall wardrobes. With two levels. Simple assembly, with six attachment points for stable wall screwing. Available in different widths. From a width of more than one meter an intermediate carrier is integrated.

**SR1200-2W**  
**SR1400-2W**

Overall width 122 cm.

Overall width 142 cm.

Product example SR1200-2W Side View:

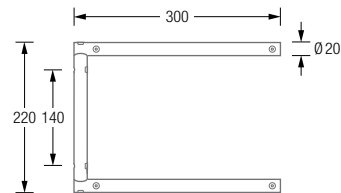

Product example SR1200-2W Plan View:

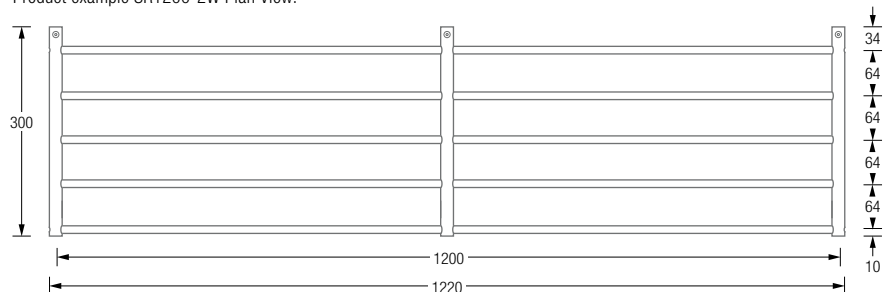





Custom sizes available.

Mounting with mounting sleeves, rosettes and Hilti fasteners\*:

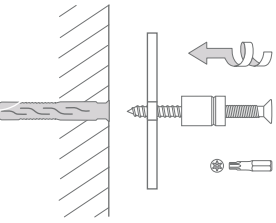

## SHOE RACK FOR WALL MOUNTING

Shoe racks made of satin finished stainless steel for wall mounting. Simple and timeless in design, the rock-solid shoe racks are also used in narrow corridors or entrance areas as a reliable helper and can be ideally combined with our wall wardrobes. Easy to assemble, with four attachment points for stable wall screwing.

Available in different widths.

- SR600-1W** Overall width 65,5 cm.
- SR700-1W** Overall width 75,5 cm.
- SR800-1W** Overall width 85,5 cm.
- SR900-1W** Overall width 95,5 cm.
- SR1000-1W** Overall width 105,5 cm.

Product example SR800-1W Side View:

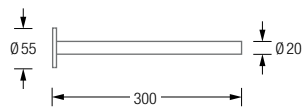

Product example SR800-1W Plan View:

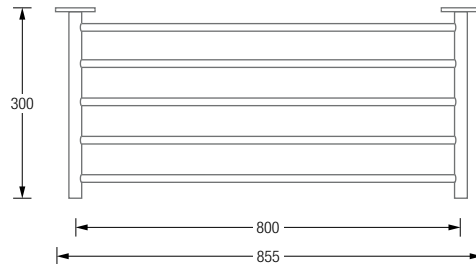

\*Stainless steel countersunk screw d 7 x 60 mm with frame dowel 10 mm (HRD-CR 10 x 60).





SR1400-1W

Custom sizes available.

## SHOE RACK FOR WALL MOUNTING

Shoe racks made of satin finished stainless steel for wall mounting. Simple and timeless in design, the rock-solid shoe racks are also used in narrow corridors or entrance areas as a reliable helper and can be ideally combined with our wall wardrobes. Easy assembly, with six attachment points for a stable wall screw connection. Available in different widths. From a width of more than one meter, an intermediate carrier is integrated.

**SR1200-1W**  
**SR1400-1W**

Overall width 125,5 cm.

Overall width 145,5 cm.

Product example SR1200-1W Side View:

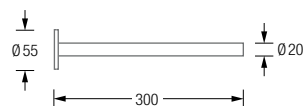

Product example SR1200-1W Plan View:

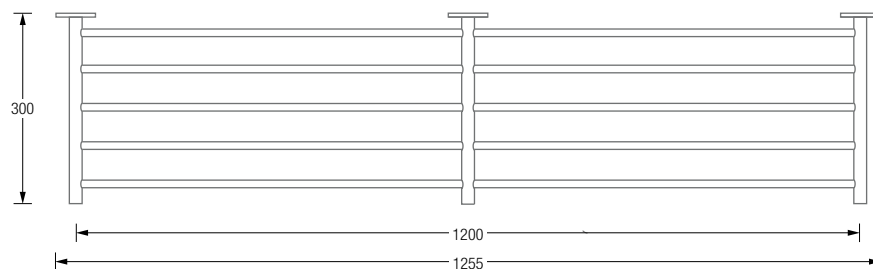





SR800-1

Custom sizes available.

## SHOE RACK

Elegant and durable shoe racks made of stainless steel, hand-polished to a silky matt finish. With adjustable feet for a secure stand. Available in many sizes.

From a width of more than one meter, an intermediate carrier is integrated.

Shoe racks with one field  
and four feet.

Shoe racks with two  
sections and six feet.

**SR600-1**

Overall width 62 cm.

**SR1200-1**

Overall width 122 cm.

**SR700-1**

Overall width 72 cm.

**SR1400-1**

Overall width 142 cm.

**SR800-1**

Overall width 82 cm.

**SR900-1**

Overall width 92 cm.

**SR1000-1**

Overall width 102 cm.

Product example SR800-1 Side View:

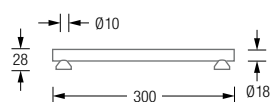

Product example SR800-1 Plan View:

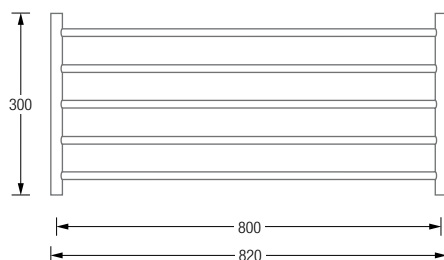

Product example SR1200-1 Plan View:

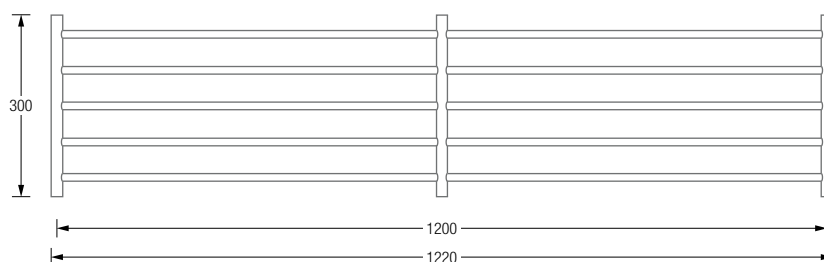



Individual woods on request.

Optionally, the shoe benches can be equipped with castors, see page 33.

# SHOE BENCHES WITH OAK WOOD SEATS

The combination with a seat made of solid oak wood that has been oiled twice gives our solid shoe benches an additional function as a seat or shelf. The seat height is 50 cm. With shelves that can be individually positioned (stainless steel with a satin-matt finish, hand-polished) and height-adjustable feet to compensate for uneven floors. The classic and simple design can be combined with any interior and is a long-lasting companion. In combination with the PHOS wardrobes, there are many design options. Available in various standard widths.

- SB600-2-Oak** With two levels, overall width 65 cm.
- SB800-2-Oak** With two levels, overall width 85 cm.
- SB1000-2-Oak** With two levels, overall width 105 cm.

- SB300-3-Oak** With three levels, overall width 35 cm.
- SB400-3-Oak** With three levels, overall width 45 cm.
- SB500-3-Oak** With three levels, overall width 55 cm.
- SB600-3-Oak** With three levels, overall width 65 cm.
- SB800-3-Oak** With three levels, overall width 85 cm.
- SB1000-3-Oak** With three levels, overall width 105 cm.

Product example  
SB800-2-Oak Side View:

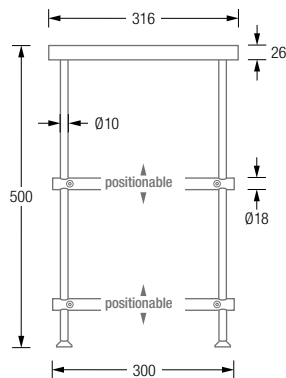

Product example  
SB800-3-Oak Side View:

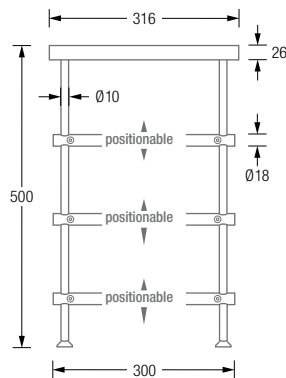

Product example SB800-2-Oak / -3-Oak Plan View:

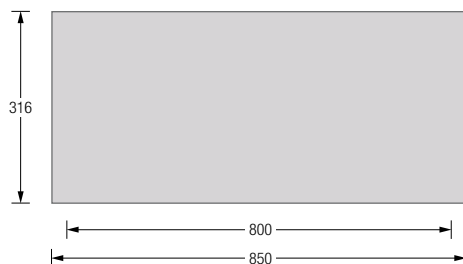





Custom sizes available.

Individual woods on request.

Optionally, the shoe benches can be equipped with castors, see page 33.

## SHOE BENCHES WITH OAK WOOD SEATS

The combination with a seat made of solid oak wood that has been oiled twice gives our solid shoe benches an additional function as a seat or shelf. The seat height is 50 cm. With individually positionable shelves (solid stainless steel, hand-polished with a silky matt finish) and height-adjustable feet to compensate for uneven floors. The classic and simple design can be combined with any interior and is a long-lasting companion. In combination with the PHOS wardrobes, there are many design options. Available in various standard widths. From a width of more than one meter, an intermediate carrier is integrated.

**SB1200-2-Oak** With two levels, overall width 125 cm.

**SB1400-2-Oak** With two levels, overall width 145 cm.

**SB1200-3-Oak** With three levels, overall width 125 cm.

**SB1400-3-Oak** With three levels, overall width 145 cm.

Product example  
SB1200-2-Oak Side View:

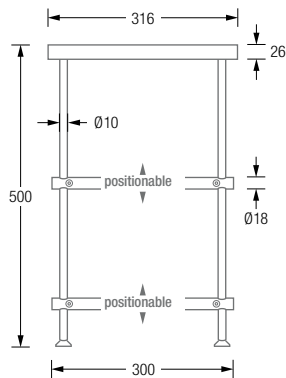

Product example  
SB1200-3-Oak Side View:

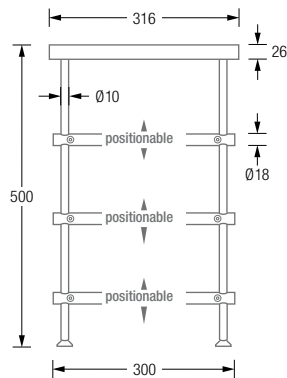

Product example SB1200-2-Oak / -3-Oak Plan View:

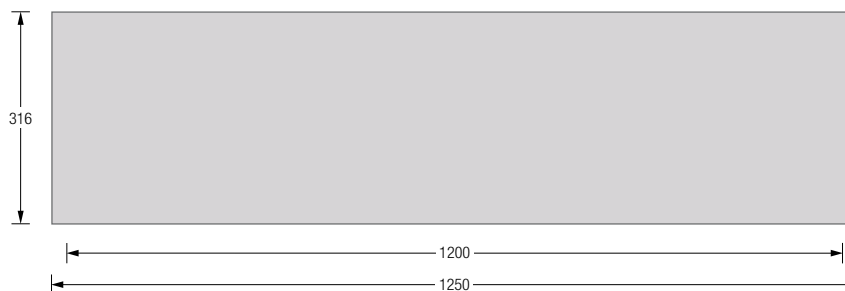





Custom sizes available.

Individual woods on request.

Optionally, the sideboards can be equipped with floor castors, see page 33.

## SIDEBOARDS WITH SHELF MADE OF OAK WOOD

Simple and elegant storage. The upper level made of solid oak wood that has been oiled twice offers additional storage space. Individually positionable shelves made of stainless steel with a satin finish. With four height-adjustable feet to compensate for uneven floors. Available in different heights and widths.

Sideboards with four levels,  
total height 70 cm.

**SBS300-4-Oak**  
**SBS400-4-Oak**  
**SBS500-4-Oak**  
**SBS600-4-Oak**  
**SBS800-4-Oak**  
**SBS1000-4-Oak**

Overall width 35 cm.  
Overall width 45 cm.  
Overall width 55 cm.  
Overall width 65 cm.  
Overall width 85 cm.  
Overall width 105 cm.

**SBS300-5-Oak**  
**SBS400-5-Oak**  
**SBS500-5-Oak**  
**SBS600-5-Oak**  
**SBS800-5-Oak**  
**SBS1000-5-Oak**

Sideboards with five levels,  
total height 85 cm.

Overall width 35 cm.  
Overall width 45 cm.  
Overall width 55 cm.  
Overall width 65 cm.  
Overall width 85 cm.  
Overall width 105 cm.

Product example  
SBS800-4-Oak Side View:

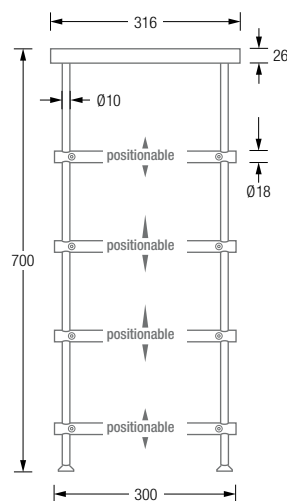

Product example  
SBS800-5-Oak Side View:

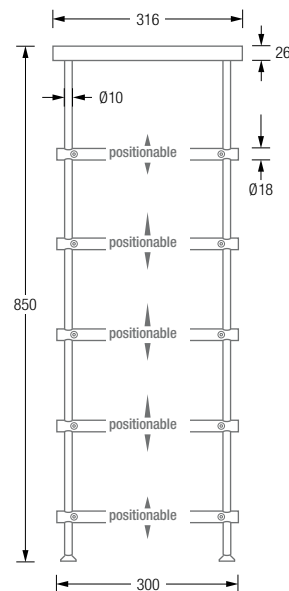

Product example SBS800-4-Oak / -5-Oak Plan View:

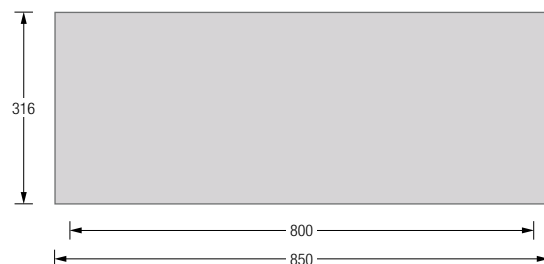





Custom sizes available.

Individual woods on request.

Optionally, the sideboards can be equipped with floor castors, see page 33..

## SIDEBOARDS WITH SHELF MADE OF OAK WOOD

Simple and elegant storage. The upper level made of solid oak wood that has been oiled twice offers additional storage space. Individually positionable shelves made of stainless steel with a satin finish. With four height-adjustable feet to compensate for uneven floors. Available in different heights and widths. From a width of more than one meter, an intermediate carrier is integrated.

Sideboards with four levels,  
Total height 70 cm.

**SBS1200-4-Oak** Overall width 125 cm.  
**SBS1400-4-Oak** Overall width 145 cm.

Sideboards mit fünf Ebenen,  
Gesamthöhe 85 cm.

**SBS1200-5-Oak** Overall width 125 cm.  
**SBS1400-5-Oak** Overall width 145 cm.

Product example  
SBS1200-4-Oak Side View:

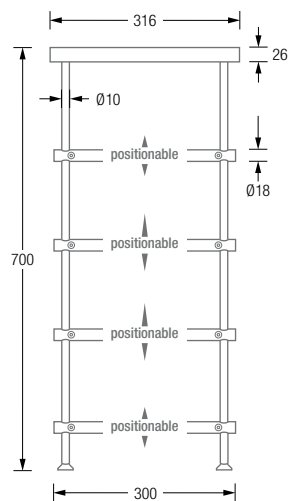

Product example  
SBS1200-5-Oak Side View:

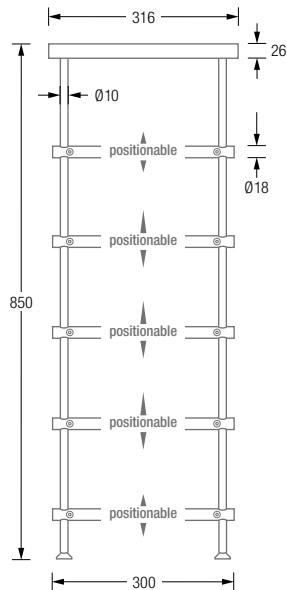

Product example SBS1200-4-Oak / -5-Oak Plan View:

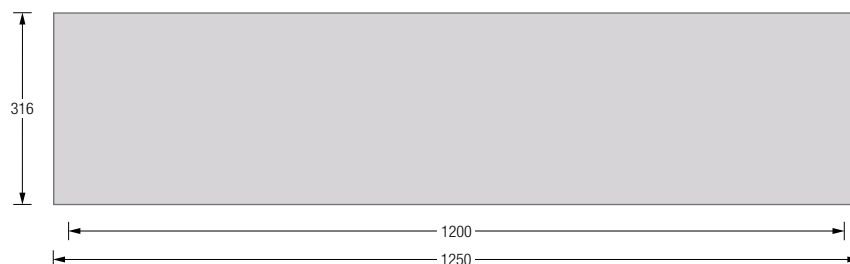



SR-ROLLER WITH BREAK



SR-ROLLER WITHOUT BREAK



SR-ROLLER-Set4



## FLOOR CASTORS / SWIVEL CASTORS

Solid, high-quality double swivel castors (rotatable through 360°) made of wear-resistant polyamide. Very good running behavior and low driving noise. The castors will replace the feet mounted (with M6 thread) - this results in an increase of 4.5 cm. Load capacity of 50kg/roller.

**SR-ROLLER-Set4**

Packaging unit: four floor castors, two of which have brakes.

**SR-ROLLER-Set6**

Packaging unit: six castors, three of which have brakes.

Floor castor without brake:

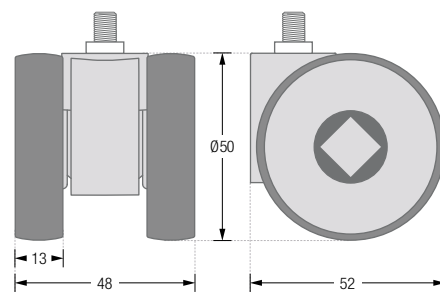

Floor castor with brake:

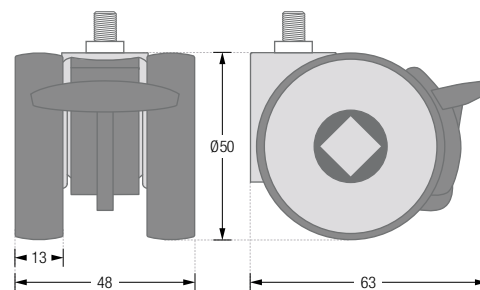



CLOAKROOM SOLUTIONS LTD  
info@cloakroomsolutions.co.uk  
020 3011 1014  
cloakroomsolutions.co.uk