

WALL RACKS



CLOAKROOM
SOLUTIONS

WALL RACK G13-1000
COAT HANGER KB2
SHOE RACK SR800-2

CLOAKROOMSOLUTIONS.CO.UK



Including mounting material.

- Optional hook HK12 see page 33.
- Optional hanging element T3H see page 34.
- Coat hanger see page 35 ff.

Assembly with cylinder head screws:

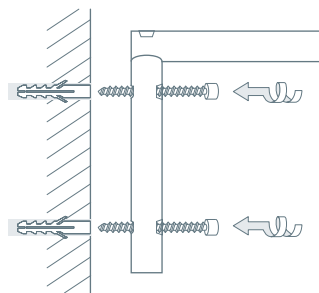

WALL RACK G13

Wall wardrobes G13 with solid wall mounting. With a clothes rail \varnothing 12 mm, solid stainless steel, hand-ground to a satin finish. From a width of more than one meter, an intermediate carrier is integrated.

AVAILABLE PRODUCTS:

G13-500	Overall width 52cm.	G13-900	Overall width 92 cm.
G13-600	Overall width 62cm.	G13-1000	Overall width 102 cm.
G13-700	Overall width 72 cm.	G13-1200	With intermediate support, overall width 122 cm.
G13-800	Overall width 82 cm.	G13-1400	With intermediate support, overall width 142 cm.

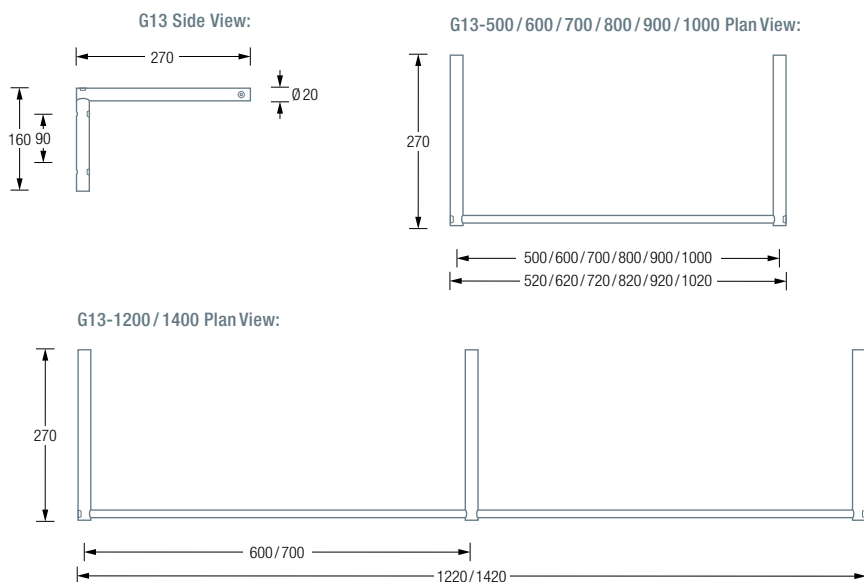



WALL RACK G13 WITH GLASS SHELF

Wall wardrobe G13 with solid wall mounting and 6 mm ESG glass shelf (Toughened safety glass, underside satined). With a clothes rail \varnothing 12 mm. Solid stainless steel, hand-polished to a satin finish. From a width of more than one meter, an intermediate carrier is integrated.

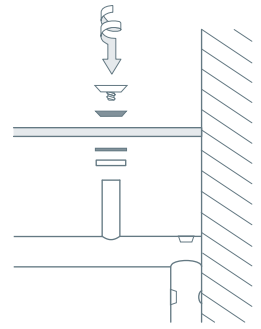

AVAILABLE PRODUCTS:

G13-500G	Overall width 55 cm.	G13-900G	Overall width 95 cm.
G13-600G	Overall width 65 cm.	G13-1000G	Overall width 105 cm.
G13-700G	Overall width 75 cm.	G13-1200G	With intermediate support, overall width 125 cm.
G13-800G	Overall width 85 cm.	G13-1400G	With intermediate support, overall width 145 cm.

WITH WOODEN SHELF

Wall-mounted coat racks G13 with solid wall mounting and 19 mm solid oak shelf, natural, oiled twice. With a clothes rail \varnothing 12 mm. Solid stainless steel, hand-polished to a satin finish. From a width of more than one meter, an intermediate carrier is integrated.

AVAILABLE PRODUCTS:

G13-500-Oak	Overall width 55 cm.	G13-900-Oak	Overall width 95 cm.
G13-600-Oak	Overall width 65 cm.	G13-1000-Oak	Overall width 105 cm.
G13-700-Oak	Overall width 75 cm.	G13-1200-Oak	With intermediate support, overall width 125 cm.
G13-800-Oak	Overall width 85 cm.	G13-1400-Oak	With intermediate support, overall width 145 cm.

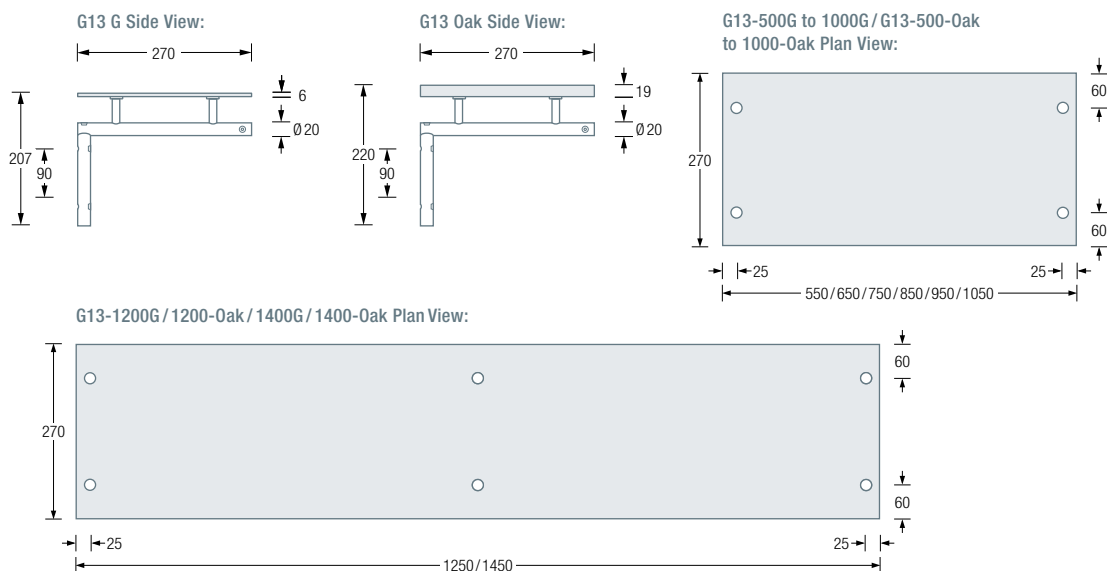

WALL RACK G15-1200
COAT HANGER KB1
HOOK HK12

CLOAKROOMSOLUTIONS.CO.UK

Coat Hanger KB2 see page 38.
Including mounting material.



Coat hanger KB1 see page 36.

Hook HK12 see page 33.

Including mounting material.

Individual widths available.

Coat Hanger KB2 see page 38.

Including mounting material.

Assembly with cylinder head screws:

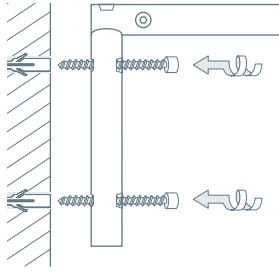

WALL RACK G15

Wall-mounted wardrobes G15 with solid wall mounting. With four crossbars \varnothing 12 mm. Solid stainless steel, hand-polished to a satin finish. From a width of more than one meter, an intermediate carrier is integrated.

AVAILABLE PRODUCTS:

G15-500	Overall width 52 cm.	G15-900	Overall width 92 cm.
G15-600	Overall width 62 cm.	G15-1000	Overall width 102 cm.
G15-700	Overall width 72 cm.	G15-1200	With intermediate support, overall width 122 cm.
G15-800	Overall width 82 cm.	G15-1400	With intermediate support, overall width 142 cm.

G15 Side View:

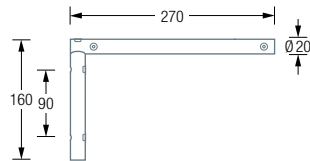

G15-500 / 600 / 700 / 800 / 900 / 1000 Plan View:

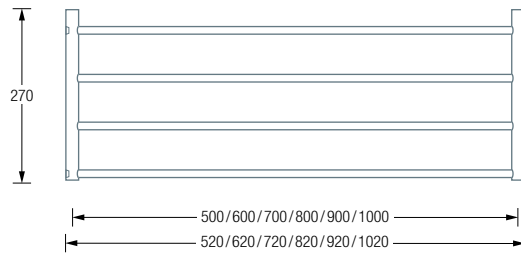

G15-1200 / 1400 Plan View:

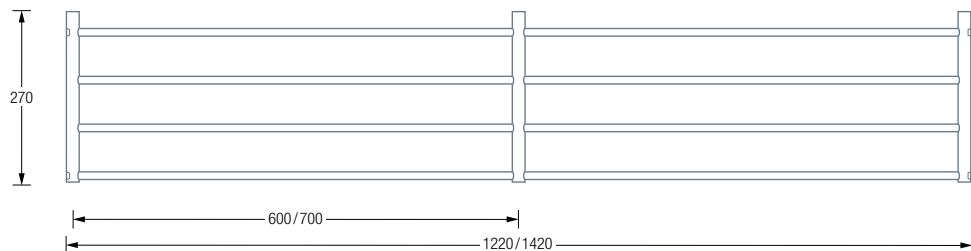

WALL RACK G15-1000G
COAT HANGER KB1
HOOK HK12
SHOE RACK RASR800-3

CLOAKROOMSOLUTIONS.CO.UK



Custom sizes available.
Including mounting material.
Glass shelf in clear glass on request.

Coat Hanger KB1 see page 36.
Hook HK12 see page 33.

WALL RACK G15 WITH GLASS SHELF

Wall wardrobes G15 with solid wall mounting and 6 mm ESG glass shelf (Toughened safety glass, underside satined). With four crossbars \varnothing 12 mm. Solid stainless steel, hand-polished to a satin finish. From a width of more than one meter, an intermediate carrier is integrated.

AVAILABLE PRODUCTS:

G15-500G	Overall width 55 cm.	G15-900G	Overall width 95 cm.
G15-600G	Overall width 65 cm.	G15-1000G	Overall width 105 cm.
G15-700G	Overall width 75 cm.	G15-1200G	With intermediate support, overall width 125 cm.
G15-800G	Overall width 85 cm.	G15-1400G	With intermediate support, overall width 145 cm.

Assembly of wooden shelf:

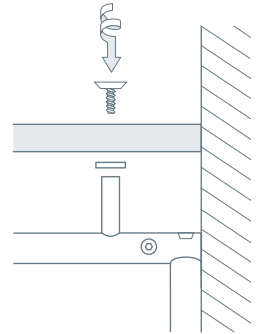

WITH WOODEN SHELF

Wall wardrobes G15 with solid wall mounting and 19 mm Solid oak shelf, natural, oiled twice. With four crossbars \varnothing 12 mm. Solid stainless steel, hand-polished to a satin finish.

AVAILABLE PRODUCTS:

G15-500-Oak	Overall width 55 cm.	G15-900-Oak	Overall width 95 cm.
G15-600-Oak	Overall width 65 cm.	G15-1000-Oak	Overall width 105 cm.
G15-700-Oak	Overall width 75 cm.	G15-1200-Oak	With intermediate support, overall width 125 cm.
G15-800-Oak	Overall width 85 cm.	G15-1400-Oak	With intermediate support, overall width 145 cm.

G15 G Side View:

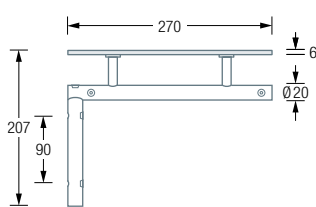

G15 Oak Side View:

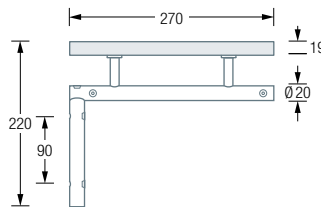

G15-500G to 1000G / G15-500-Oak to 1000-Oak Plan View:



G15-1200G / 1200-Oak / 1400G / 1400-Oak Plan View:

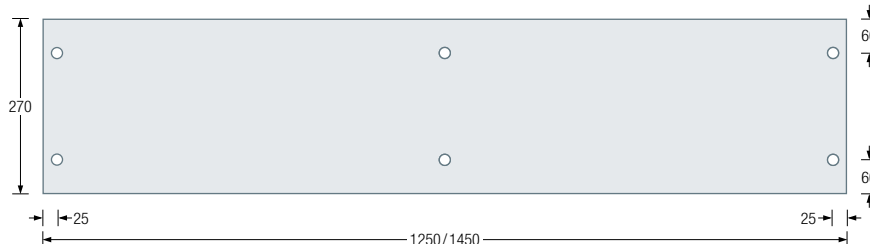

Coat Hanger KB2 see page 38.
Including mounting material.



Assembly with cylinder head screws:

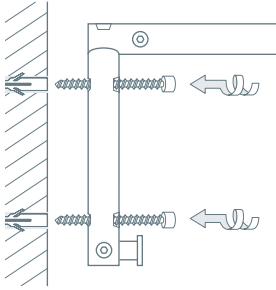

Coat Hanger KB2 see page 38.
Including mounting material.

WALL RACK G17

Wall-mounted wardrobes G17 with solid wall mounting. With four cross bars $\varnothing 12$ mm and a coat hook bar. Solid stainless steel, hand-polished to a satin finish. From a width of more than one meter, an intermediate carrier is integrated.

AVAILABLE PRODUCTS:

- G17-500** Overall width 52 cm, with five coat hooks.
- G17-600** Overall width 62 cm, with five coat hooks.
- G17-700** Overall width 72 cm, with five coat hooks.
- G17-800** Overall width 82 cm, with five coat hooks.
- G17-900** Overall width 92 cm, with six coat hooks.
- G17-1000** Overall width 102 cm, with six coat hooks.

- G17-1200** With intermediate support, overall width 122 cm, with ten coat hooks.
- G17-1400** With intermediate support, overall width 142 cm, with ten coat hooks.

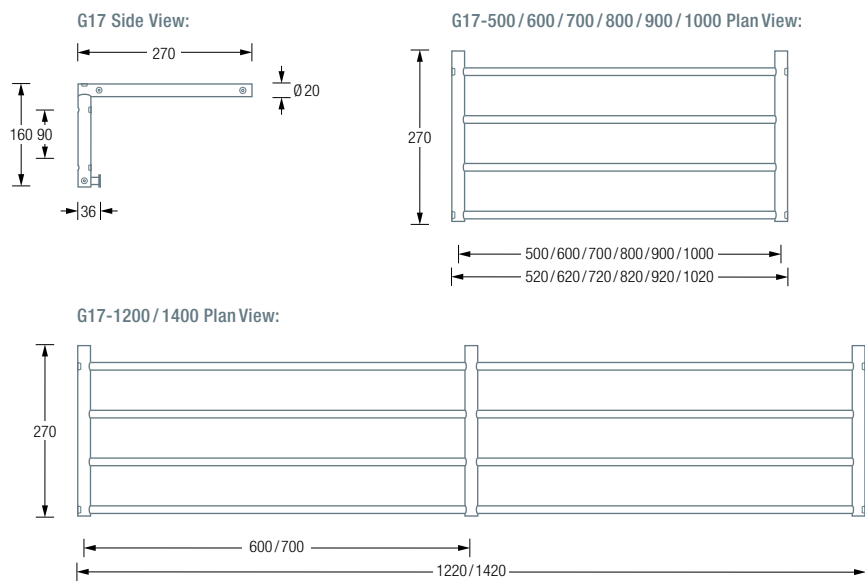

WALL RACK G17-1000-Oak
COAT HANGER KB1
SHOE RACK SB800-2-Oak

CLOAKROOMSOLUTIONS.CO.UK



WALL RACK G17 WITH GLASS SHELF

Wall wardrobe G17 with solid wall mounting and 6 mm ESG glass shelf (toughened safety glass, underside satined). With four cross bars \varnothing 12 mm and a coat hook bar. Solid stainless steel, hand-polished to a satin finish. From a width of more than one meter, an intermediate carrier is integrated.

AVAILABLE PRODUCTS:

G17-500G	Overall width 55 cm, with five coat hooks.
G17-600G	Overall width 65 cm, with five coat hooks.
G17-700G	Overall width 75 cm, with five coat hooks.
G17-800G	Overall width 85 cm, with five coat hooks.
G17-900G	Overall width 95 cm, with six coat hooks.
G17-1000G	Overall width 105 cm, with six coat hooks.
G17-1200G	With intermediate support, overall width 125 cm, with ten coat hooks.
G17-1400G	With intermediate support, overall width 145 cm, with ten coat hooks.

WITH WOODEN SHELF

Wall-mounted wardrobes G17 with solid wall mounting and 19 mm solid oak shelf, natural, oiled twice. With four cross bars \varnothing 12 mm and a coat hook bar. Solid stainless steel, hand-polished to a satin finish. From a width of more than one meter, an intermediate carrier is integrated.

AVAILABLE PRODUCTS:

G17-500-Eiche	Overall width 55 cm, with five coat hooks.
G17-600-Eiche	Overall width 65 cm, with five coat hooks.
G17-700-Eiche	Overall width 75 cm, with five coat hooks.
G17-800-Eiche	Overall width 85 cm, with five coat hooks.
G17-900-Eiche	Overall width 95 cm, with six coat hooks.
G17-1000-Eiche	Overall width 105 cm, with six coat hooks.
G17-1200-Eiche	With intermediate support, overall width 125 cm, with ten coat hooks.
G17-1400-Eiche	With intermediate support, overall width 145 cm, with ten coat hooks.

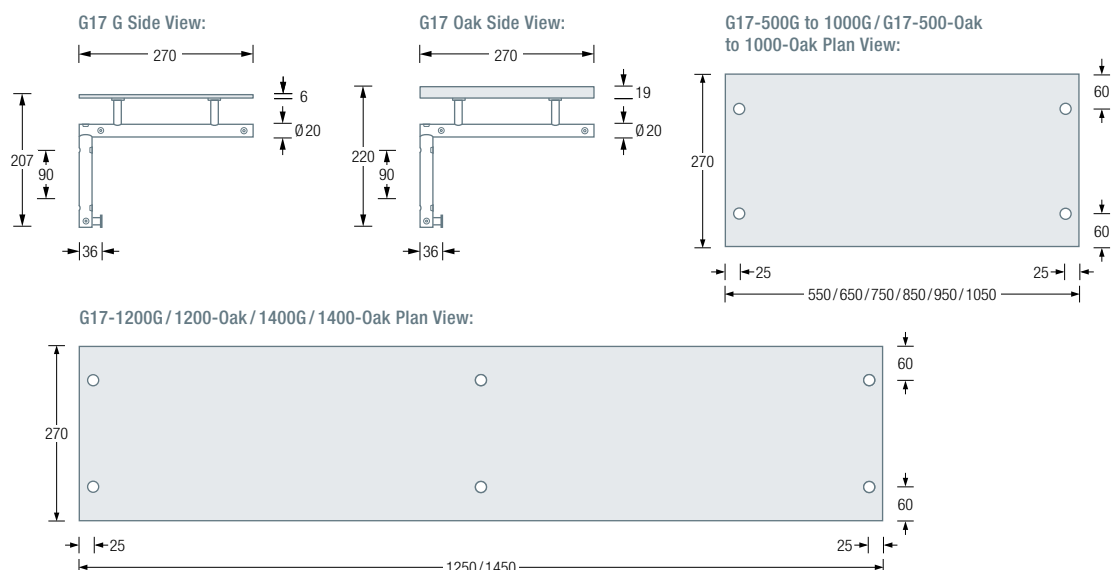



WALL RACK G18-1000G
COAT HANGER KB1
HOOK HK12 AND HK16
SHOE RACK SR800-2W

WALL RACK **G18-800** COAT
HANGER **KB1**
HOOK **HK16**

CLOAKROOMSOLUTIONS.CO.UK

Coat Hanger **KB2** see page **38**.
Including mounting material.



Coat hanger KB1 see page 36.

Hook HK16 see page 33.

Including mounting material.

Individual widths available.

Coat Hanger KB2 see page 38.

Including mounting material.

Assembly with cylinder head screws:

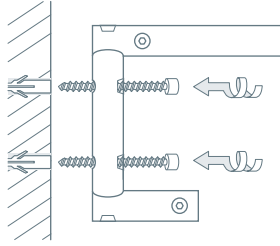

WALL RACK G18

Wall wardrobes G18 with solid wall mounting. With four upper crossbars \varnothing 12 mm and one lower clothes rail \varnothing 16 mm. Solid stainless steel, hand-polished to a satin finish. From a width of more than one meter, an intermediate carrier is integrated.

AVAILABLE PRODUCTS:

G18-500	Overall width 52 cm.
G18-600	Overall width 62 cm.
G18-700	Overall width 72 cm.
G18-800	Overall width 82 cm.
G18-900	Overall width 92 cm.
G18-1000	Overall width 102 cm.
G18-1200	With intermediate support, overall width 122 cm.
G18-1400	With intermediate support, overall width 142 cm.

G18-500 / 600 / 700 / 800 / 900 / 1000 Plan View:

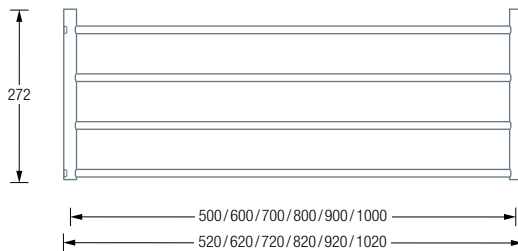

G18 Side View:

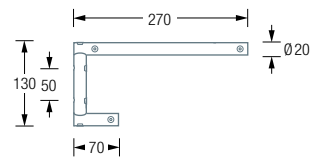

G18-1200 / 1400 Plan View:

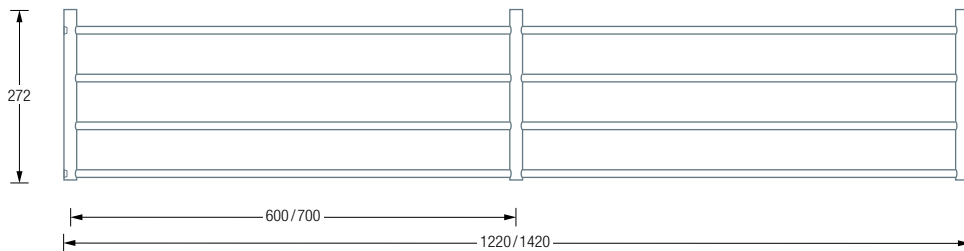

WALL RACK G18-1200-Oak

COAT HANGER KB1

HOOK HK12

CLOAKROOMSOLUTIONS.CO.UK

Coat Hanger KB2 see page 38.
Including mounting material.



Hook HK12 see page 33.
Coat Hanger KB1 see page 36.

Including mounting material.
Individual widths available.

Assembly of wooden shelf:

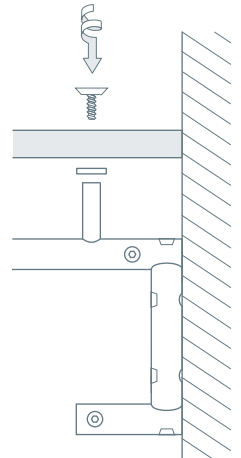

WALL RACK G18 WITH GLASS SHELF

Wall wardrobes G18 with solid wall mounting and 6 mm ESG glass shelf (single-pane safety glass, underside satined). With four upper crossbars \varnothing 12 mm and one lower clothes rail \varnothing 16 mm. Solid stainless steel, hand-polished to a satin finish. From a width of more than one meter, an intermediate carrier is integrated.

AVAILABLE PRODUCTS:

G18-500G	Overall width 55 cm.	G18-900G	Overall width 95 cm.
G18-600G	Overall width 65 cm.	G18-1000G	Overall width 105 cm.
G18-700G	Overall width 75 cm.	G18-1200G	With intermediate support, overall width 125 cm.
G18-800G	Overall width 85 cm.	G18-1400G	With intermediate support, overall width 145 cm.

WITH WOODEN SHELF

Wall-mounted coat racks G18 with solid wall mounting and 19 mm solid oak shelf, natural, oiled twice. With four upper crossbars \varnothing 12 mm and one lower clothes rail \varnothing 16 mm. Solid stainless steel, hand-polished to a satin finish. From a width of more than one meter, an intermediate carrier is integrated.

AVAILABLE PRODUCTS:

G18-500-Eiche	Overall width 55 cm.	G18-900-Eiche	Overall width 95 cm.
G18-600-Eiche	Overall width 65 cm.	G18-1000-Eiche	Overall width 105 cm.
G18-700-Eiche	Overall width 75 cm.	G18-1200-Eiche	With intermediate support, overall width 125 cm.
G18-800-Eiche	Overall width 85 cm.	G18-1400-Eiche	With intermediate support, overall width 145 cm.

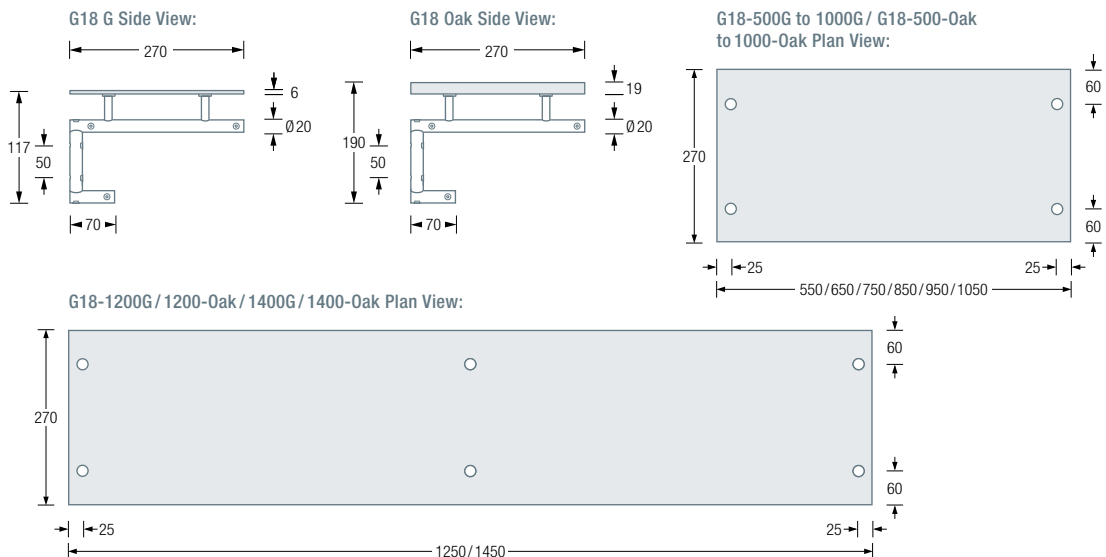





WALL RACK GU1

Wall-mounted wardrobe GU1 bent from one piece, with U-shaped clothes rail \varnothing 12 mm with solid wall mounting and diagonal wall suspensions. Solid stainless steel, hand-polished to a satin finish. From a width of more than one meter, an additional wall suspension is integrated..

AVAILABLE PRODUCTS:

- GU1-500** With two wall suspensions, overall width 52 cm.
- GU1-600** With two wall suspensions, overall width 62 cm.
- GU1-700** With two wall suspensions, overall width 72 cm.
- GU1-800** With two wall suspensions, overall width 82 cm.
- GU1-900** With two wall suspensions, overall width 92 cm.
- GU1-1000** With two wall suspensions, overall width 102 cm.

- GU1-1200** With three wall suspensions, overall width 122 cm.
- GU1-1400** With three wall suspensions, overall width 142 cm.
- GU1-1600** With three wall suspensions, overall width 162 cm.

Coat Hanger KB1 see page 36.

Including mounting material.

Available in individual widths

Planning information on the ceiling height with diagonal wall bracing: The required height of the wall attachment point at 45°, including space for installation, corresponds approximately to the overhang of the wall wardrobe.

Mounting with mounting sleeve and wall bracket STF:

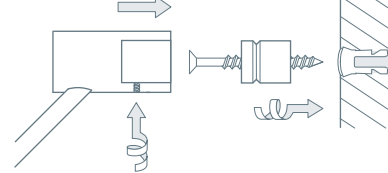

Installation with wall bracket WL12K:

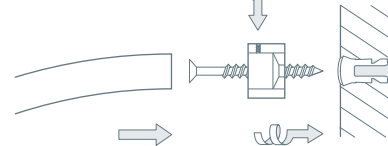

GU1-500 / 600 / 700 / 800 / 900 / 1000 Plan View:

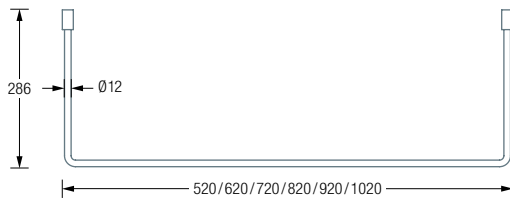

GU1 Side View:

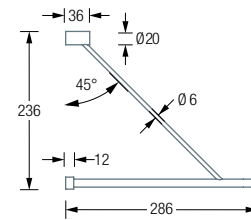

GU1-1200 / 1400 / 1600 Plan View:

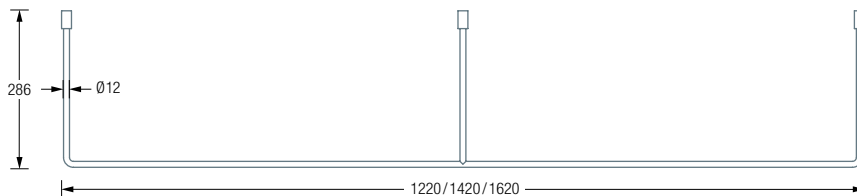



Coat Hanger KB1 see page 36.

Custom sizes available.

Including mounting material.

CLOAKROOMSOLUTIONS.CO.UK

Coat Hanger KB2 see page 38.

Including mounting material.



Optional Hanging element T3H see page 34.

WALL RACK G4

Wall-mounted coat racks G4 with solid attachment using hat rosettes and Hilti attachment material*. With a clothes rail \varnothing 12 mm, solid stainless steel, hand-polished to a satin finish. From a width of more than one meter, an intermediate support is integrated.

AVAILABLE PRODUCTS:

G4-500	Overall width 54 cm.	G4-900	Overall width 94 cm.
G4-600	Overall width 64 cm.	G4-1000	Overall width 104 cm.
G4-700	Overall width 74 cm.	G4-1200	With intermediate support, overall width 124 cm.
G4-800	Overall width 84 cm.	G4-1400	With intermediate support, overall width 144 cm.

G4-500 / 600 / 700 / 800 / 900 / 1000 Plan View:

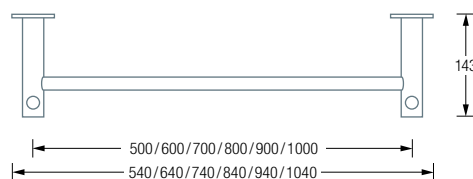

G4 Side View:

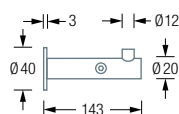

G4-1200 / 1400 Plan View:

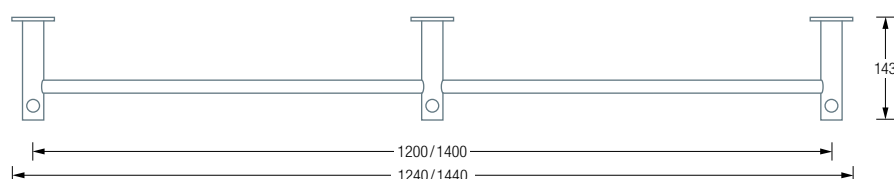

Installation with Hilti countersunk screw HRD-CR 10 x 60 and rosette R40H:

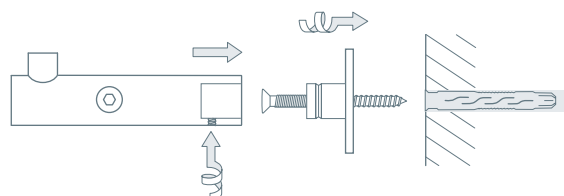

*Stainless steel countersunk screw d 7 x 60 mm with frame dowel 10 mm (HRD-CR 10 x 60).



Customising available.

Including mounting material.
Glass shelf in clear glass on request.

Assembly of glass shelf:

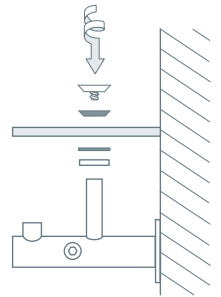

WALL RACK G4 WITH GLASS SHELF

Wall coat racks G4 with solid attachment using hat rosettes and Hilti attachment material*. With 6 mm ESG glass shelf (toughened safety glass, underside satined). With a clothes rail \varnothing 12 mm, stainless steel solid, silky-matt hand sanded. From a width of more than one meter, an intermediate carrier is integrated.

AVAILABLE PRODUCTS:

G4-500G	Overall width 55 cm.	G4-900G	Overall width 95 cm.
G4-600G	Overall width 65 cm.	G4-1000G	Overall width 105 cm.
G4-700G	Overall width 75 cm.	G4-1200G	With intermediate support, overall width 125 cm.
G4-800G	Overall width 85 cm.	G4-1400G	With intermediate support, overall width 145 cm.

WITH WOODEN SHELF

Wall coat racks G4 with solid attachment using hat rosettes and Hilti attachment material*. With 19 mm solid oak shelf, natural, oiled twice. With a clothes rail \varnothing 12 mm, solid stainless steel, hand-polished to a satin finish. From a width of more than one meter, an intermediate carrier is integrated.

AVAILABLE PRODUCTS:

G4-500-Oak	Overall width 55 cm.	G4-900-Oak	Overall width 95 cm.
G4-600-Oak	Overall width 65 cm.	G4-1000-Oak	Overall width 105 cm.
G4-700-Oak	Overall width 75 cm.	G4-1200-Oak	With intermediate support, overall width 125 cm.
G4-800-Oak	Overall width 85 cm.	G4-1400-Oak	With intermediate support, overall width 145 cm.

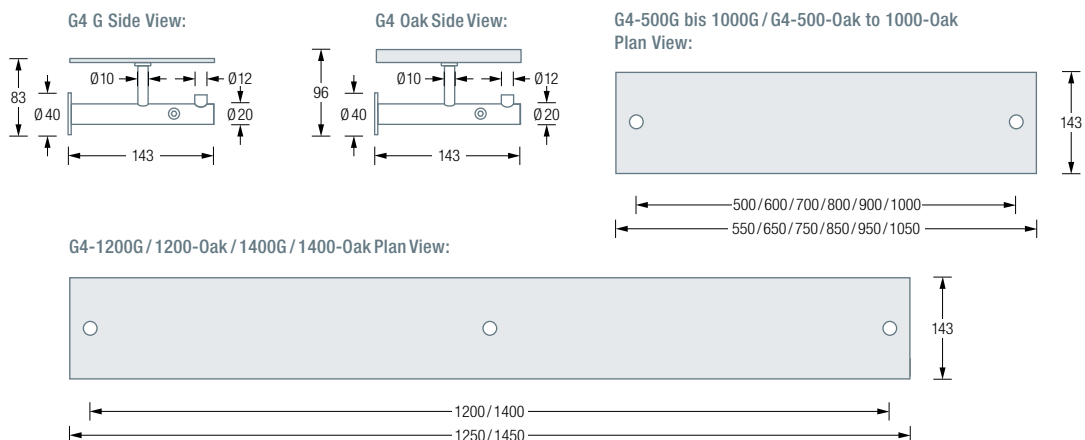

*Stainless steel countersunk screw d 7 x 60 mm with frame dowel 10 mm (HRD-CR 10 x 60).



CURVED WALL RACK SEMI CIRCLE

Semi-circular wall-mounted coat racks with solid wall attachment and diagonal wall suspension. With clothes rail \varnothing 12 mm, Solid stainless steel, hand-polished to a satin finish.

AVAILABLE PRODUCTS:

G300HW Radius 30 cm, Overall width 61,8 cm, Depth 31 cm, Height 26,9 cm.

G400HW Radius 40 cm, Overall width 81,8 cm, Depth 41 cm, Height 36,9 cm.

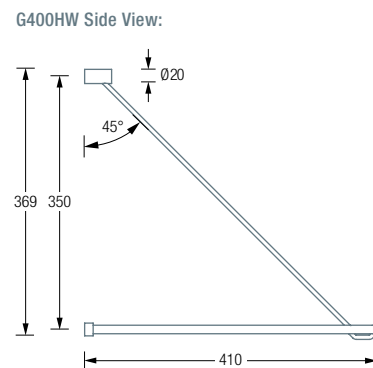
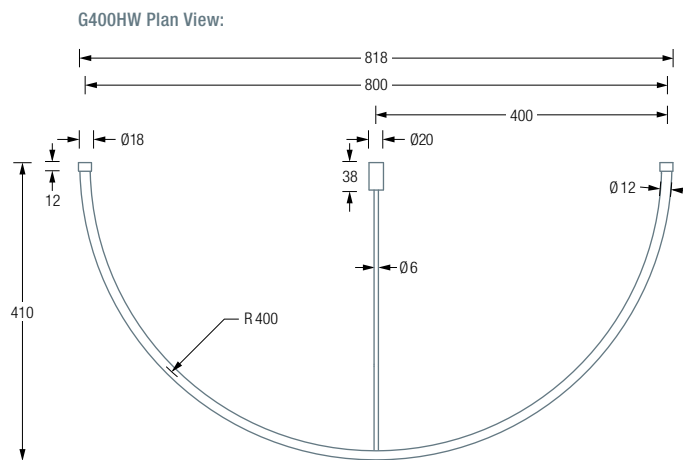
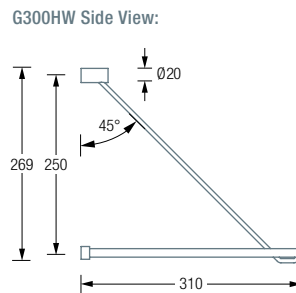
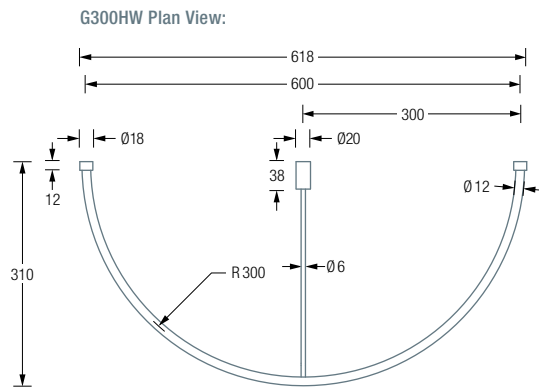
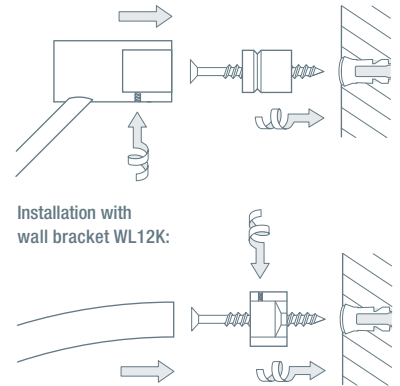





Custom sizes available.

Including mounting material.

Coat Hanger KB1 see page 36.

Hanging Element T3H see page 34.

CURVED WALL RACK CLOSE TO THE WALL

- G45** Curved coat rack with solid attachment and diagonal wall suspension. With clothes rail \varnothing 12 mm. Width 91.8 cm, depth 24.5 cm, height 20.4 cm. Solid stainless steel, hand-polished to a satin finish.

G45 Plan View:

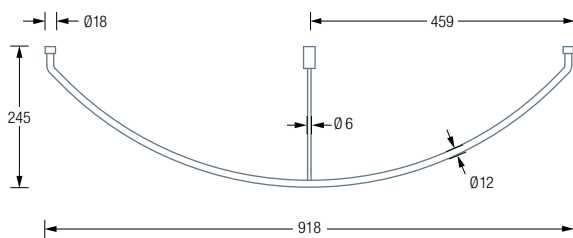

G45 Side View

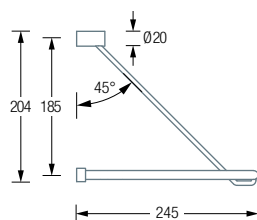

Mounting with mounting sleeve and wall bracket STF:

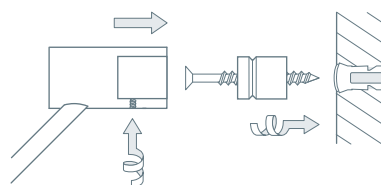

Installation with wall bracket WL12K:

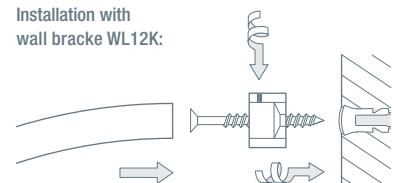

CORNER WALL RACK **G400VW**
COAT HANGER **KB1**

CLOAKROOMSOLUTIONS.CO.UK

Coat Hanger KB2 see page **38**.
Including mounting material.



G300VW | KB1

Custom
Sizes Available.
Including mounting
material for wall fixing.
Coat Hanger KB1
see page 36.
Please allow sufficient
ceiling clearance.



CORNER CURVED WALL RACK QUARTER CIRCLE WITH WALL SUSPENSION

Quarter-circle corner wardrobes with solid wall mounting and diagonal wall suspension. With clothes rail \varnothing 12 mm. Solid stainless steel, hand-polished to a satin finish.

AVAILABLE PRODUCTS:

G300VW	Radius 30 cm, Depth 31,3 cm, Height 25,9 cm.
G400VW	Radius 40 cm, Depth 41,3 cm, Height 36 cm.
G500VW	Radius 50 cm, Depth 51,3 cm, Height 46 cm.

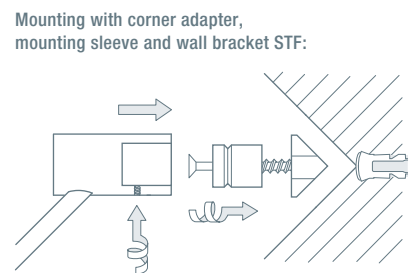
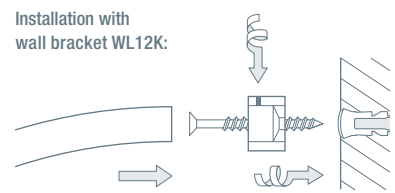

G300VW Side View:

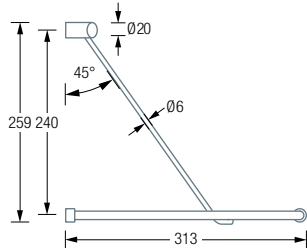

G300VW Plan View:

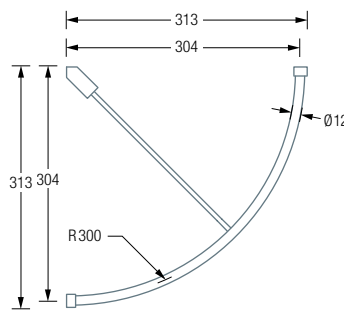

G500VW Side View:

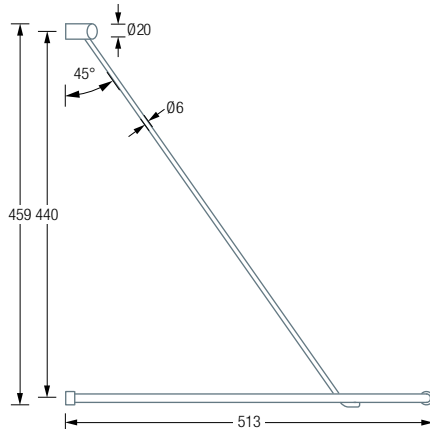

G500VW Plan View:

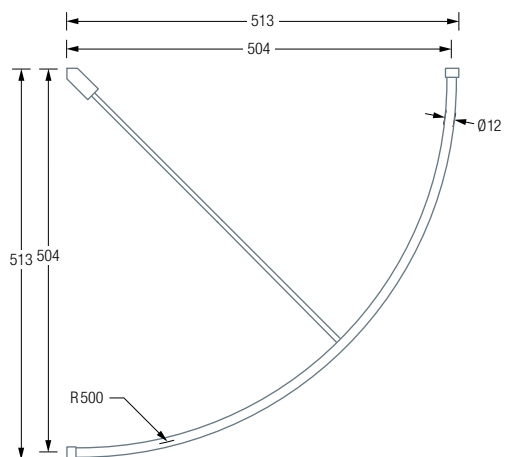

Coat Hanger KB2 see page 38.
Including mounting material.



FOLDING COAT RACK KLR600



FOLDING WALL RACK

Folding coat racks Sant'Anselmo with four coat rails \varnothing 12 mm and two additional lower coat hooks. Solid screw connection with oval rosettes. Foldable to save space if required, ideal for hallways or small rooms.

AVAILABLE PRODUCTS:

- KLR600** Overall width 63,4 cm.
- KLR700** Overall width 73,4 cm.
- KLR800** Overall width 83,4 cm.
- KLR900** Overall width 93,4 cm.

KLR600 / 700 / 800 / 900 Front View Unfolded:

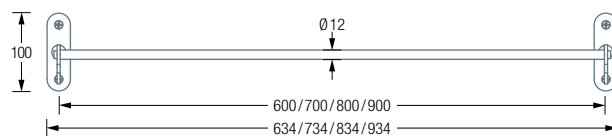

KLR600 / 700 / 800 / 900
Side View Unfolded:

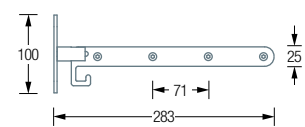

KLR600 / 700 / 800 / 900 Front View Folded:

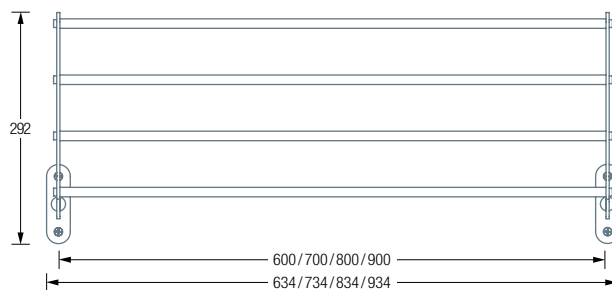

KLR600 / 700 / 800 / 900
Side View Folded:

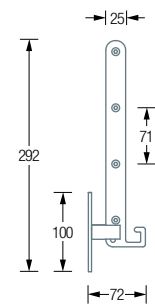

Installation with oval rosette:

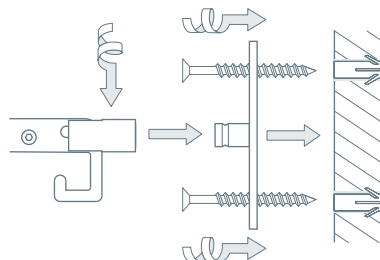



WALL RACK ACCESSORIES

COAT HOOK

Coat hook for threading and fixing on clothes rails. Includes black protective cap*. Solid stainless steel, hand-polished ring element.

AVAILABLE PRODUCTS:

- HK12** For stainless steel bars $\varnothing 12$ mm.
HK16 For stainless steel bars $\varnothing 16$ mm.
HK18 For stainless steel bars $\varnothing 18$ mm.
HK20 For stainless steel bars $\varnothing 20$ mm.

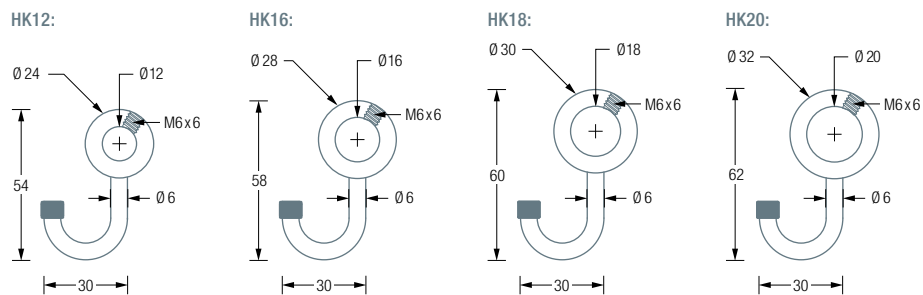

- HKS** S-hook for stainless steel rods up to $\varnothing 20$ mm.
HKC C-hook for stainless steel rods up to $\varnothing 18$ mm.

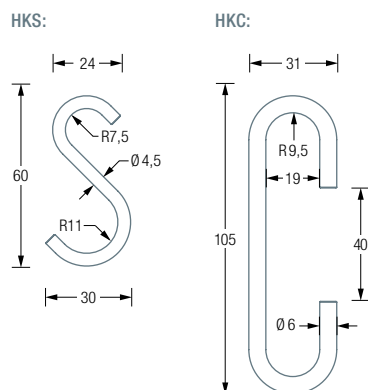

*Material: PE (polyethylene), matt black. High chemical resistance, good sliding properties.

T3F



T3H



WALL RACK ACCESSORIES

HANGING ELEMENTS

Take 3 hanging elements with three coat hooks that can be rotated 360°, for clothes rails \varnothing 12 mm. Solid stainless steel, hand-polished to a satin finish. Also available in custom lengths.

AVAILABLE PRODUCTS:

- T3H** Take 3 hanging element for hanging.
T3F Take 3F hanging element for theft-proof threading and optional fixing.

T3H Side View:

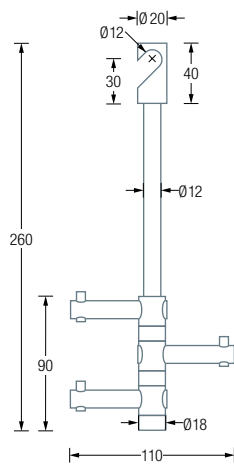

T3F Side View:

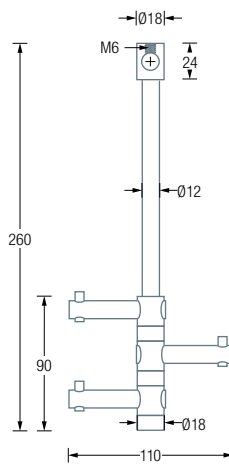

COAT HANGER KB1



KB1H



KB1G

35 PHOS

COAT HANGER

Coat hanger with a concealed 360° rotating mechanism and an elegant connection detail with no visible screw connection. Stainless steel, solid material \varnothing 10 mm, brushed silky matt.

AVAILABLE PRODUCTS:

KB1 Coat hanger.

KB1H Coat and trouser hanger.

KB1G Coat hanger for public areas with a closed eye (anti-theft).

KB1HG Coat and trouser hangers for public areas with a closed eye (anti-theft protection).

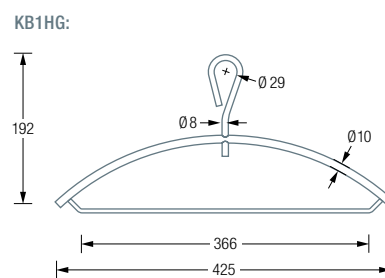
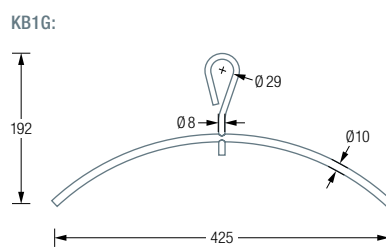
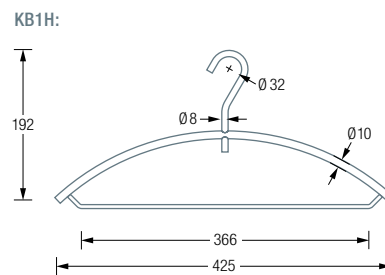
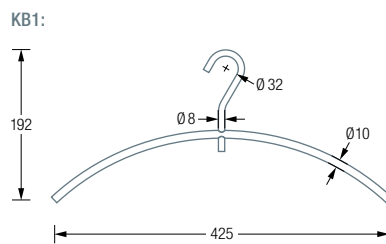

Coat Hanger KB2 see page 38.
Including mounting material.



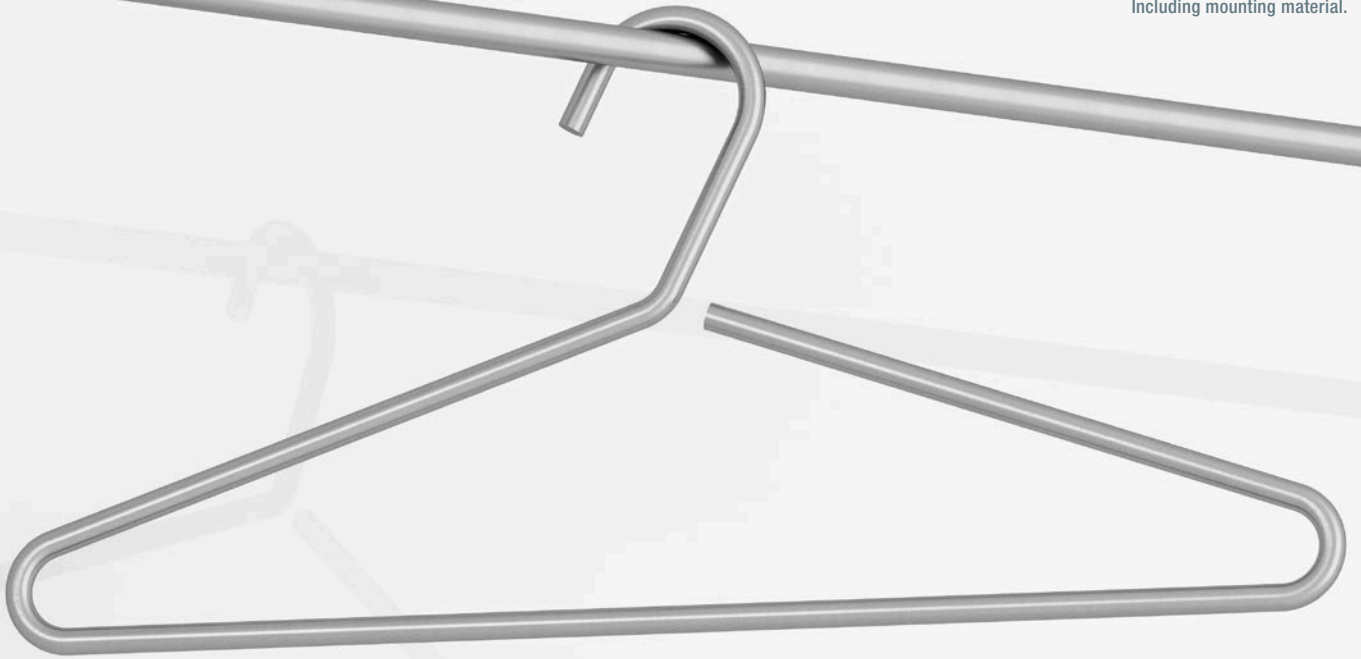

KB2

COAT HANGER

KB2 Coat and trouser hanger bent from one piece.
Stainless steel, solid material \varnothing 8 mm, brushed silky matt.

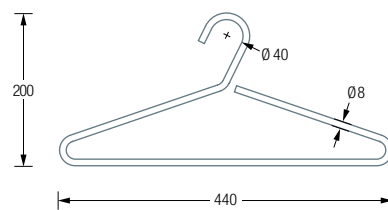



CLOAKROOM SOLUTIONS LTD
info@cloakroomsolutions.co.uk
020 3011 1014
cloakroomsolutions.co.uk