



PLAY QUEST

Est 1991

A life of play...

www.playquest.co.uk

The Company first started trading in 1990 as “Playquest”, it was then incorporated as “Podium Properties Ltd” in 1994 but continued to trade under the name “Playquest”.

A name change to “Playquest Adventure Play Ltd” occurred in 1998, to reflect the shift in focus towards the Children’s Playground business.

Playquest Adventure Play Ltd is today a well-established, financially sound and respected company, offering a full range of products and services to operators of children’s playgrounds.

The products and services offered by Playquest Adventure Play Ltd include:

Nationwide fully-trained sales managers that will assist you through all aspects of planning your play area. They will advise on the best location, type of equipment and safer surfacing for your individual play area project.

Playground design - both from our standard range and bespoke, unique designs where required.

A wide range of play equipment - Play Equipment, Outdoor Gym Equipment, Thermo-Plastic Playground Markings, Garden Furniture, etc.

Supply and installation of all types of Safer Surfacing - Wetpour, PlayBond, Grass Mats, Woodchip, etc.

Groundworks and installation by fully trained installation teams - who are CRB checked and have CSCS accreditation.

Post-installation service, safety certificates and operator guidelines where required. A comprehensive replacement parts service. Annual maintenance service including - New parts where required, adjustments of fixings where needed, a full inspection report and safety certificate.

The company is proud to support environmental objectives by using timber taken only from sustainable sources, and offering a range of play equipment manufactured from virtually maintenance-free recycled plastic.

Our very large existing customer base will happily testify to the quality of the company’s products and services, delivered over many years.

Our customers consider the company ideally suited and particularly successful when installing all types of play equipment, where it is important that the whole process is handled with efficiency and professional care. We install on time and leave everything as it should be left.

We work to high professional standards, through written procedures and operate a meaningful health and safety regime.

We are also accredited members of **Constructionline, CHAS, Acclaim, RoSPA, and API** - giving you peace of mind that you have chosen the right company to assist you in creating your ideal play area.

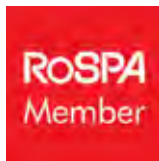

CONTENT

01	PLAYHOUSES PLATFORMS & ACTIVITY CENTRES	1 - 6
02	FUN & FITNESS TRAIL	7 - 12
03	FITNESS ITEMS	13 - 16
04	THEMED PLAY	17 - 20
05	CLIMBING FRAMES	21 - 24
06	PLAY FRAMES	25 - 28
07	SWINGS & RUNWAYS	29 - 32
08	GYM EQUIPMENT	33 - 34
09	SENSORY ITEMS	35 - 36
10	INTERACTIVE PANELS	37 - 38
11	ACTIVITY NETS / CONE CLIMBERS & ROUNDABOUTS	39 - 40
12	SWING ROCKERS & RIDERS/ SEE SAWS	41 - 42
13	SHELTERS	43 - 44
14	RECYCLED PLASTIC	45 - 46
15	FENCING & ANCILLARY	47 - 48
16	SURFACING	49 - 50

Size = actual size of equipment

CFH = Critical Fall Height for surfacing requirements.

Space = The overall minimum area required including free space around the equipment.

The equipment can be modified to suit in some cases.

Contact us

PlayQuest Adventure Play Ltd
Bethania Chapel, Main Road
Ffynnongroew
Flintshire CH8 9SW

Tel: 01745 561117
Fax: 01745 561091
Web: www.playquest.co.uk



From the Single Playhouse right through to the Platform Play 1, our range of Playhouses, Platforms and Activity Centres is suited to users of all ages - from young children to adults - as they combine the imaginative fun of playhouses, along with physical activities such as slides, ramps, and scramble nets - and upper-body strength challenges like Overhead Ladder Bars, Russian Rings, Gym Rings, etc.

Most of the items within this range are available with 600mm; 1m; or 1.2m height platforms - these options allow the unit to be installed onto a suitable grass surface without the need for additional safer surfacing. Some units are also available with a 1.5m - 2m platform with additional safer surfacing required.

Note that where slides are fitted, our large fibreglass Bumpy slide can be fitted onto these items - if the platform height is over 1.2m. Stainless steel slides are also available for these units (additional cost may apply).

Additional features can be added to the items within this range, including ramps, interactive game panels, nets, additional slides, almost anything (within reason!). Most of these products can also be adapted for users with special needs.

Most of these units can be manufactured from either timber or recycled plastic. Some of these products can be adapted for a younger age group, such as nursery or primary age children, with lower platform heights, easier access if required, brightly coloured interactive panels and play tunnels.

"To the builders, thank you for building our new playground, you have been such a pleasure, thank you." - Pupils of Grange Park Primary School."



Item #1111
Playcentre 1

Size: 4.6m x 3.6m
CFH: 0.6m - 1.2m
Space: 8m x 7m
Age: 3-7

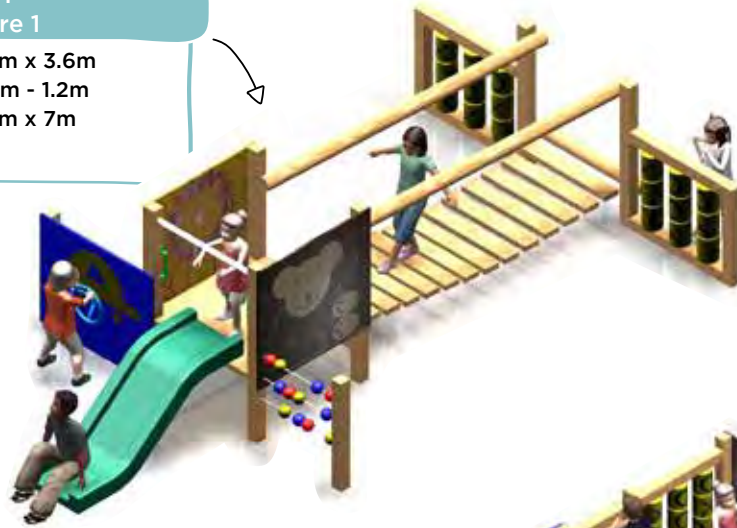

Item #1121
Playcentre 2

Size: 6.9m x 2.7m
CFH: 0.6m - 1.2m
Space: 9m x 5m
Age: 3-7



Item #1131
Playcentre 3

Size: 6m x 5.8m
CFH: 0.6m - 1.2m
Space: 8m x 8m
Age: 3-7

Item #0080
Small Playhouse

Size: 1.2m x 1.2m
Space: 2m x 2m
Age: 3-11



Item #1151
1 Tower Activity Centre

Size: 4.5m x 4m
CFH: 0.6m - 1.5m
Space: 7m x 7m
Age: 3-11



Item #1171
2 Tower Activity Centre

Size: 9m x 4.6m
CFH: 0.6m - 1.5m
Space: 12m x 8m
Age: 3-11



Item #1181
3 Tower Activity Centre

Size: 7.5m x 6m
CFH: 0.6m - 1.5m
Space: 11m x 9m
Age: 3-11



Item #0300
4 Tower Activity Centre

Size: 9m x 6.5m
CFH: 0.6m - 1.5m
Space: 12m x 10m
Age: 3-11





Item #0221
PlayVille 2

Size: 9.5m x 5.5m
CFH: 0.6m - 1.5m
Space: 13m x 9m
Age: 3-11



Item #0291
Twin House Activity Centre

Size: 10m x 7m
CFH: 0.6m - 1.2m
Space: 13m x 10m
Age: 3-11

Item #0201
The Explorer

Size: 4.6m x 2.2m
CFH: 0.6m - 1.2m
Space: 8m x 8m
Age: 3-11





Item #1251
The Shanty

Size: 4m x 3m
CFH: 0.6m - 1.5m
Space: 7m x 6m
Age: 5-11

Item #1191
Toddler Town

Size: 4.6m x 2.2m
CFH: 0.6m - 1.2m
Space: 8m x 5m
Age: 3-7



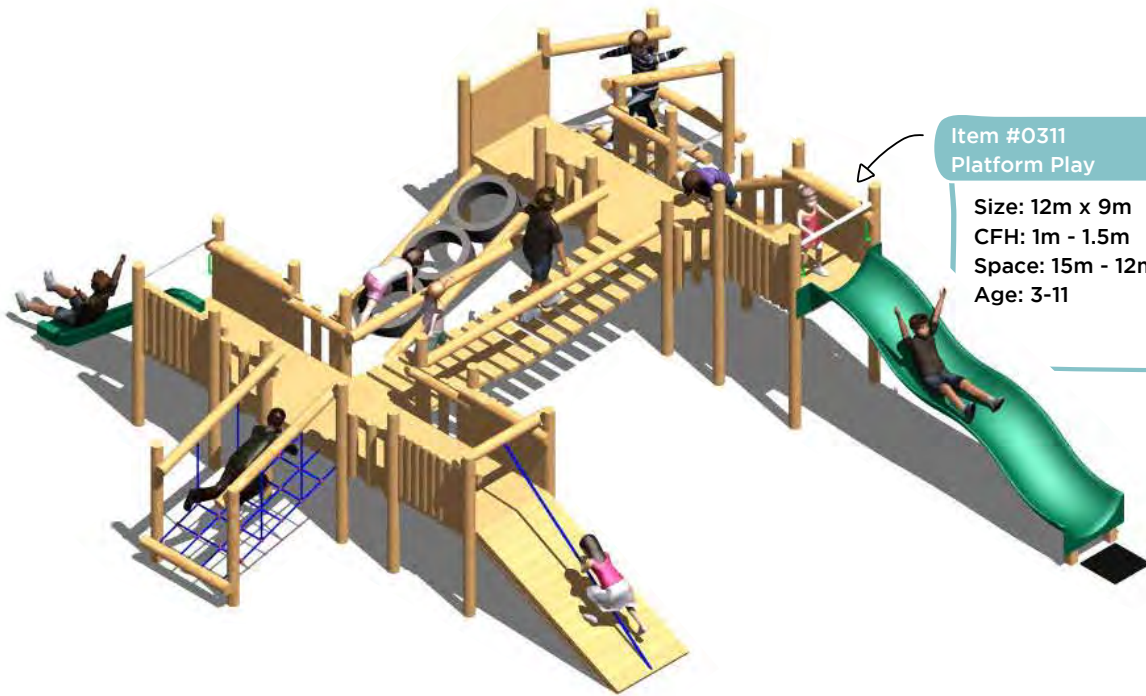

More designs on our website - www.playquest.co.uk



Fun Trail items are brilliant at assisting in the development of the users co-ordination, balance and agility. From easy to navigate items such as the Balance Beam to the harder items to negotiate such as the Traverse Wall, fun trails provide countless hours of stimulating fun and activities for users of all ages.

Fun trail items can be combined to make a unique, exciting adventure trail for both children and adults. In most instances, the objective of a trim-trail is for the user to progress from one item to the next in a circuit or trail, mainly without touching the ground. The user will quickly identify this objective, rise to this challenge, and take on the trim trail with a sense of adventure which sparks their imaginations as they play!

As well as a range of 'standard' fun trails, we also offer a 'mix & match' option - so you can create your unique trim trail using any number of our individual trail items. Since we started in 1991, we have installed

countless numbers of adventure trails - small to large - in schools, caravan parks, open parks, public houses, etc. All have proved to be very popular with the people using them.

Quite often, most of our standard trim trails can be installed in just one or two days, which means minimal disruption to the play area.

Please note that if you wish to maximise the use of your trim trail equipment all year round, it would be advisable to install some playground surfacing around the trail equipment.

"Just a quick email to say how impressed we are with your company and the contractors we have on site, fantastic job so far.... we are more than delighted with the work and their conduct. I'd definitely recommend your company on to potential customers any time."
Mrs Alison Boulton - Grange Park Primary School."



Item #0671
Budget Trail 1

Size: 11.2m x 9m
CFH: 0.6m
Space: 13.2m x 11m
Age: 3-adult



Item #0672
Budget Trail 2

Size: 10.8m x 4.3m
CFH: 0.6m
Space: 12.8m x 6.3m
Age: 3-adult



Item #0673
Budget Trail 3

Size: 8.7m x 8.7m
CFH: 0.6m
Space: 10.7m x 10.7m
Age: 3-adult

Item #0630
Fun Trail 1

Size: 10.5m x 9.7m
CFH: 0.6m
Space: 12.5m x 11.7m
Age: 3-adult

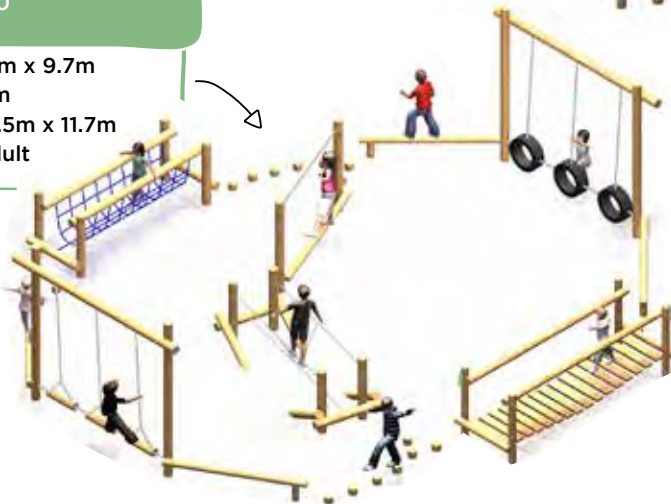

Item #0640
Fun Trail 2

Size: 10.5m x 10m
CFH: 0.6m
Space: 12.5m x 12m
Age: 3-adult

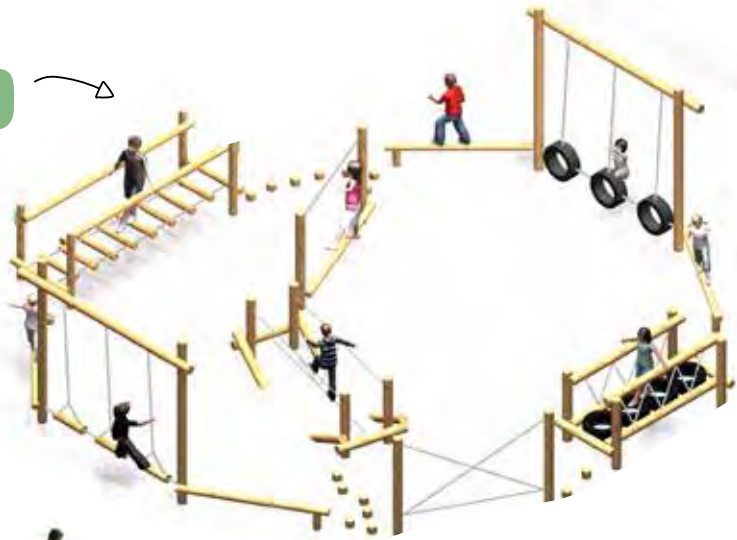

Item #0661
Mini Trail 1

Size: 9.5m x 1m
CFH: 0.6m
Space: 12m x 3m
Age: 3-adult

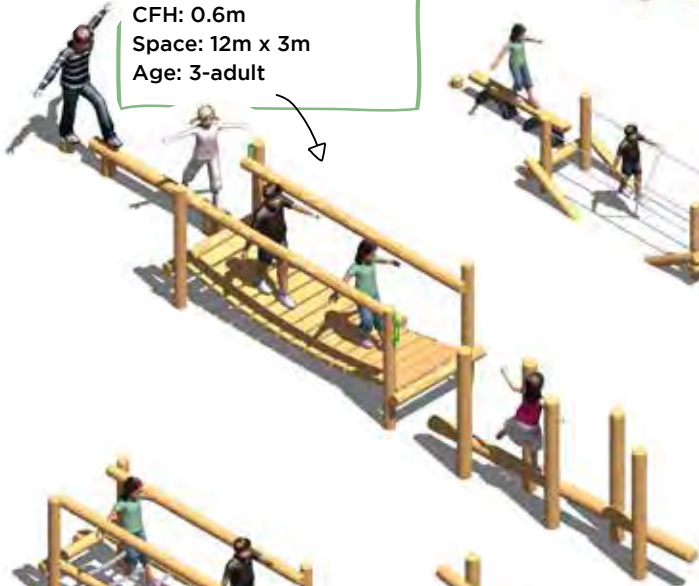

Item #0662
Mini Trail 2

Size: 15.5m x 1.5m
CFH: 0.6m
Space: 18m x 4m
Age: 3-adult



Item #0663
Mini Trail 3

Size: 14m x 1.2m
CFH: 0.6m
Space: 16m x 3m
Age: 3-adult

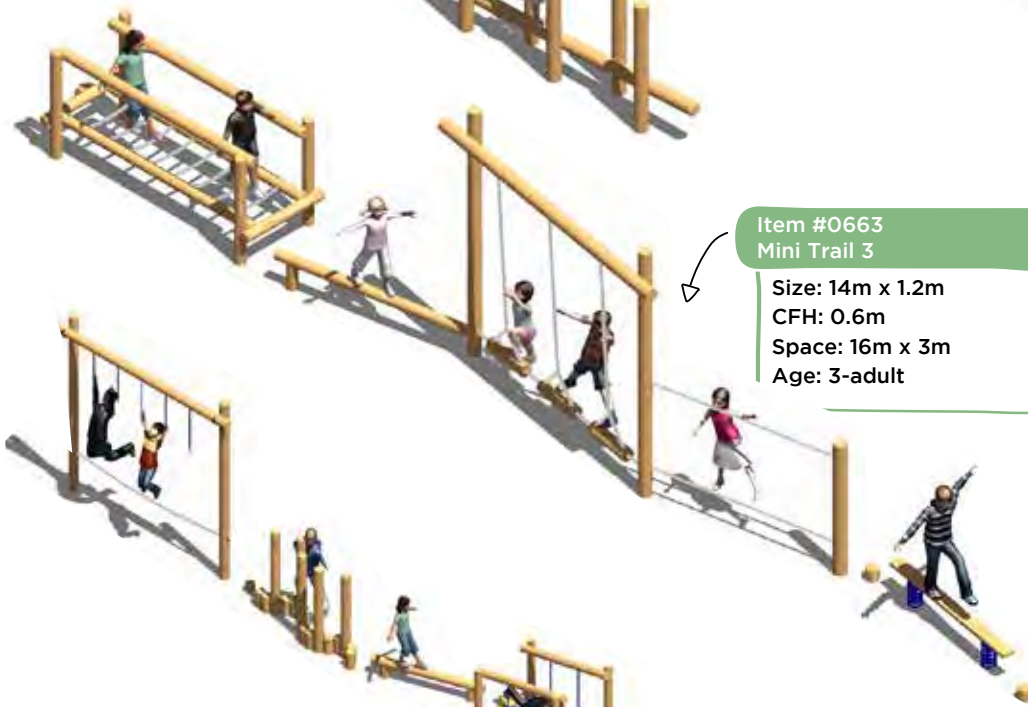

Item #0664
Mini Trail 4

Size: 19m x 1.2m
CFH: 0.6m
Space: 21m x 3m
Age: 3-adult





Item #0665
Mini Trail 5

Size: 19m x 4m
CFH: 2.2m
Space: 21m x 6m
Age: 3-adult

Item #0666
Mini Trail 6

Size: 13.5m x 0.5m
CFH: 0.6m
Space: 16m x 3m
Age: 3-adult



Item #0679
Rope Rush

Size: 12.5m x 11m
CFH: 2m
Space: 17m x 11m
Age: 5-adult

Item #0677
Pursuit Trail

Size: 9.5m x 8.7m
CFH: 0.6m
Space: 11.5m x 10.7m
Age: 3-adult



Item #0676
Sprint Agility Trail

Size: 15.8m x 12m
CFH: 0.6m
Space: 17.8m x 14m
Age: 3-adult



Item #0675
Venture Trail

Size: 10.3m x 9.4m
CFH: 0.6m
Space: 12.3m x 11.4m
Age: 3-adult

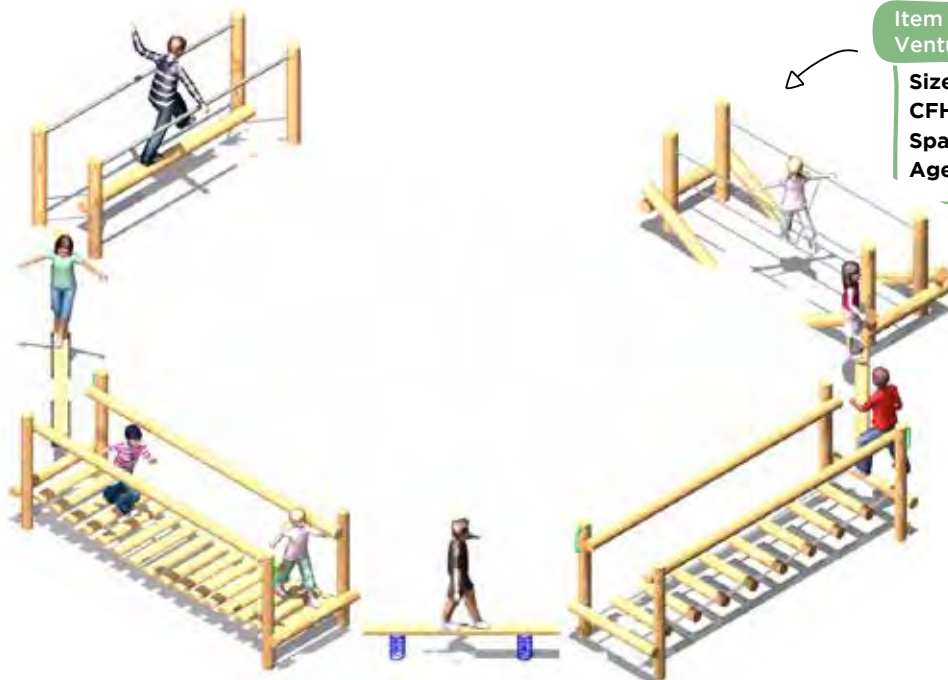

Item #0415
Log Climber

Size: 1.8m x 1.8m
CFH: 1.3m
Space: 4.5m x 4.5m
Age: 5-adult



Item #0431
Crawl Tunnel

Size: 1.2m x 1m
Space: 2m x 2m
Age: 3-11



Item #0612
Mini Hammock Net

Size: 4.5m x 1.8m
CFH: 1m
Space: 7m x 4m
Age: 5-adult

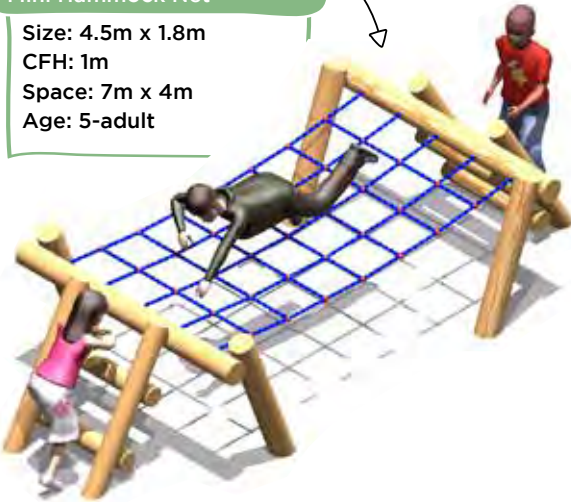

Item #0417
Scamble Net Log Climber

Size: 1.8m x 1.8m
CFH: 1.5m
Space: 5m x 5m
Age: 5-adult

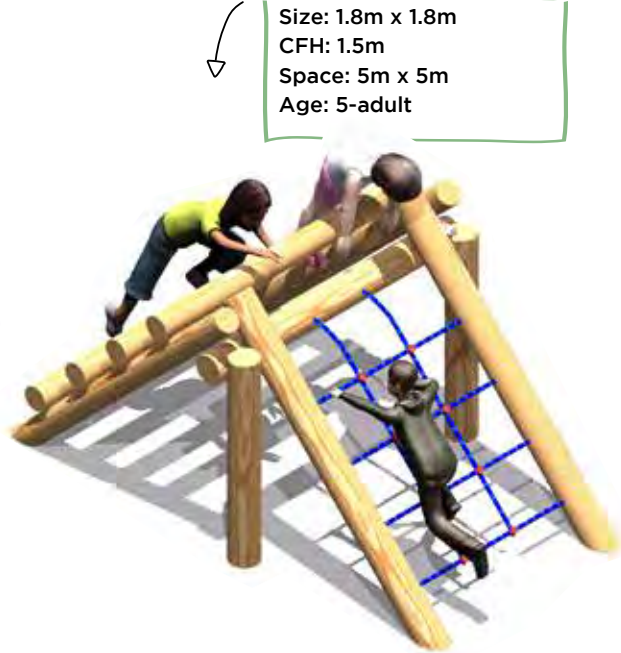

Item #0407
Tyre Climber

Size: 1m x 1m
CFH: 1.5m
Space: 4m x 4m
Age: 5-11



Item #0901
Traverse Wall

Size: 3m x 2m x 0.25m
CFH: 1m
Space: 5m x 2m
Age: 5-adult

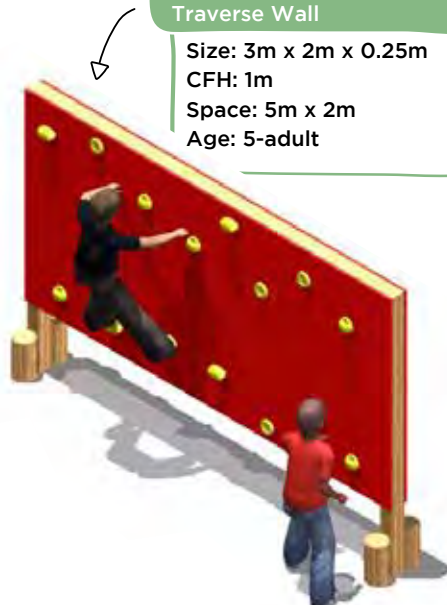



Designed to be more challenging than Fun Trail items, our Fitness range is excellent at assisting in the development of the user's upper-body strength, co-ordination, as well as providing cardiovascular exercise. From easy to navigate items such as the Step Ups to the harder items to negotiate such as the Overhead Ladder Cross, our Fitness items provide countless hours of stimulating fun and exercise.

The Fitness items can be combined to make a unique, exciting fitness trail or circuit for older children, teenagers and adults. For most items in this range, a safer surface other than grass will be required, due to the Critical Fall Heights of the equipment.

Quite often, most of these items can be installed in just one or two days, which means minimal disruption to the play area. Fitness trail items can be installed individually or in any configuration, making it suitable for practically any site. These fitness trail items are designed to test the levels of physical ability, strength, agility, co-ordination and overall stamina.

"The kids and the school are over the moon with the playground so thank you so much! Your guys did an outstanding job of it. We are already planning the fundraising activities to add onto the playground next year."

Mrs Georgina Hodgson -Hooton Pagnell All Saints CE Primary School

Item #1090
Assault Climb

Size: 3.4m x 2.9m
CFH: 1.8m
Space: 7m x 6m
Age: 7-adult

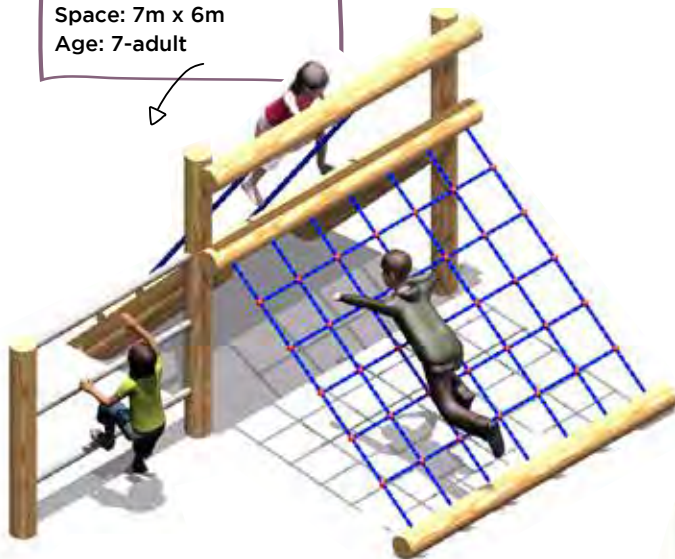

Item #0820
Chin Ups/ Tumble Bars

Size: 4m x 0.125m
CFH: 2.2m
Space: 8m x 4m
Age: 7-adult



Item #1032
Fitness Station 1

Size: 4m x 2.7m
CFH: 2.3m
Space: 6.8m x 6m
Age: 7-adult



Item #0830
Gym Rings

Size: 3m x 0.125m
CFH: 2.2m
Space: 7m x 4m
Age: 7-adult

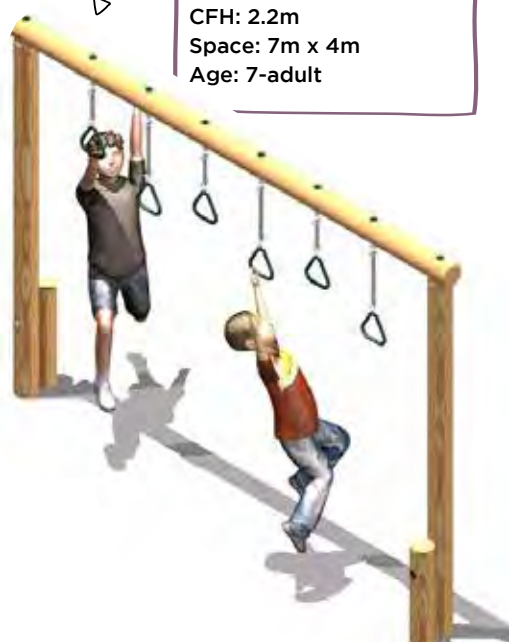

Item #0500
Overhead Ladder Monkey Bar

Size: 3m x 0.25m
CFH: 2.2m
Space: 7m x 4m
Age: 7-adult



Item #0790
Overhead Ladder Cross

Size: 3m x 1m
CFH: 2.2m
Space: 7m x 5m
Age: 7-adult

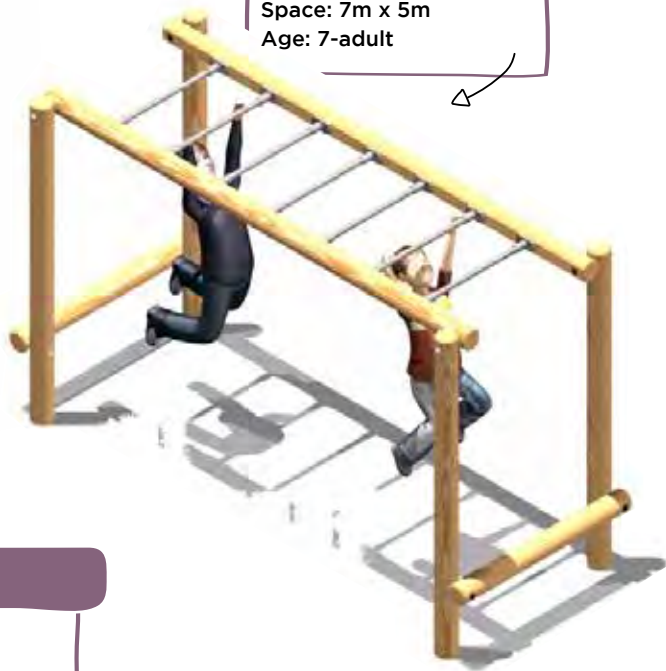

Item #0880
Pole Climb

Size: 3m x 0.25m
CFH: 2m
Space: 7m x 5m
Age: 7-adult

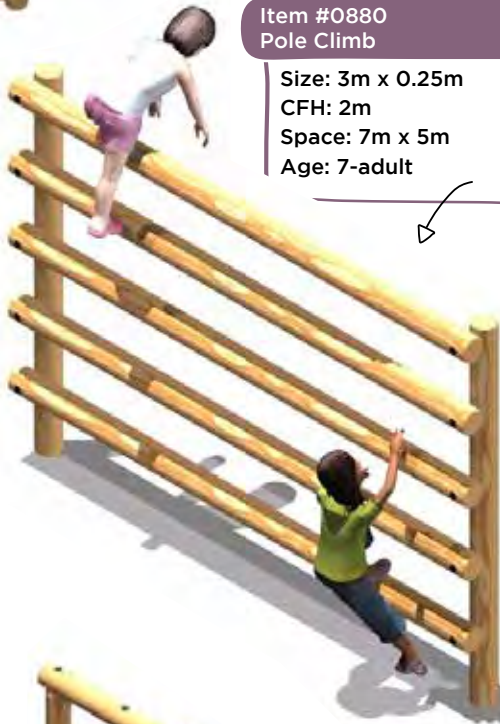

Item #0890
Rope Climb

Size: 3.6m x 0.125m
CFH: 2.85m
Space: 7.5m x 6m
Age: 7-adult

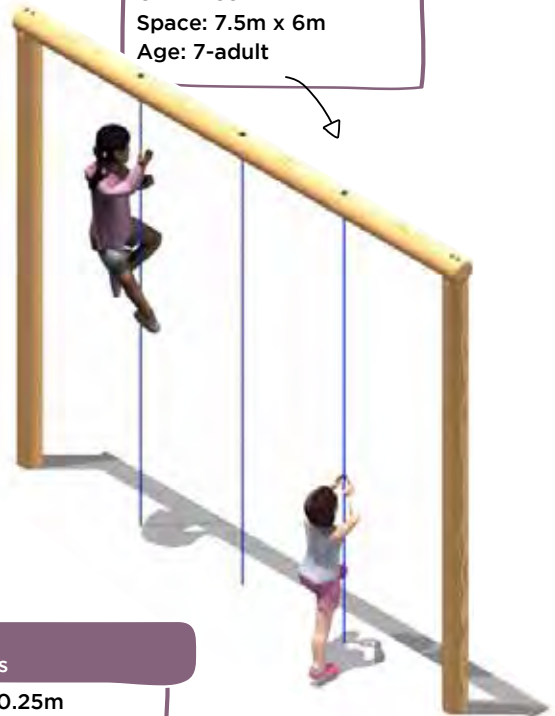

Item #0510
Russian Rings

Size: 3m x 0.25m
CFH: 2.2m
Space: 7m x 4m
Age: 7-adult



Item #0850
Scramble Net Climbing Frame

Size: 3m x 2m
CFH: 2m
Space: 7m x 5m
Age: 5-adult

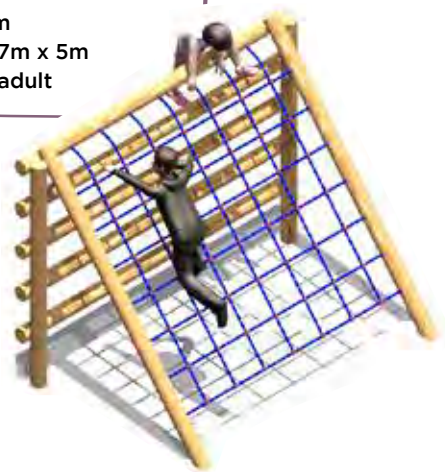

Item #0982
Scramble Net Climbing Frame Combi

Size: 4.2m x 2.7m
CFH: 2.2m
Space: 8m x 6m
Age: 5-adult

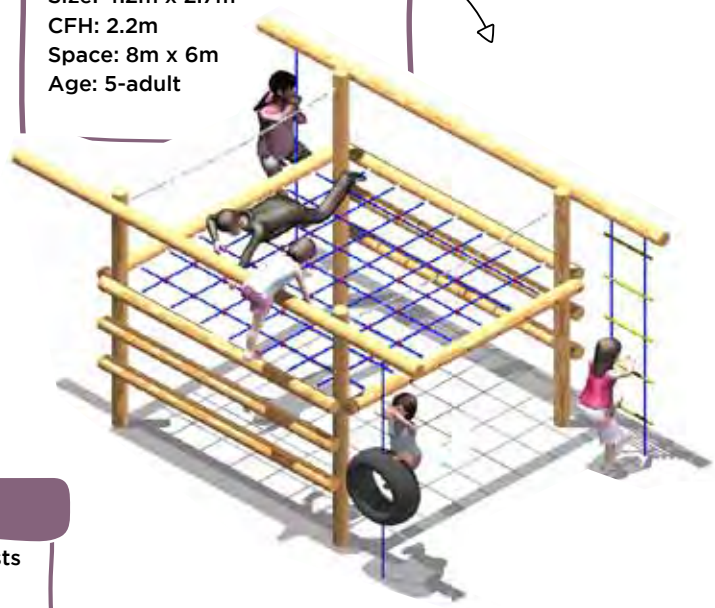

Item #0770
Step Ups

Size: 0.2m x 0.2m posts
CFH: 0.6m - 1m
Space: 2m x 2m
Age: 5-adult



Item #0625
Traverse Scamble Net

Size: 2.8m x 0.125m
CFH: 0.75m
Space: 4.8m x 2m
Age: 5-adult

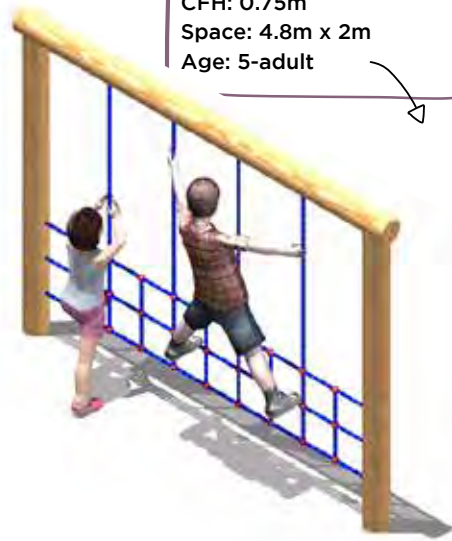

Item #0622
Vertical Scamble Net

Size: 2.8m x 0.125m
CFH: 2.2m
Space: 7m x 4m
Age: 7-adult

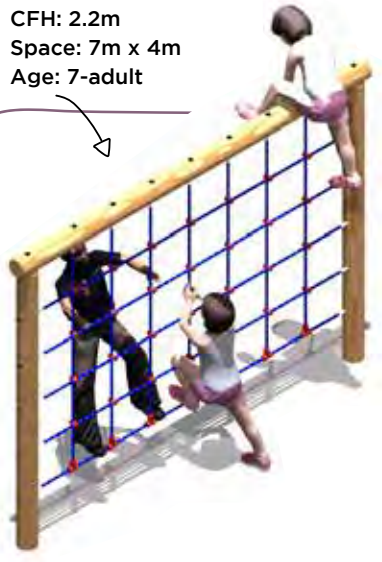

Item #1051
X-ite Mk1

Size: 8.7m x 1.6m
CFH: 2m
Space: 12.5m x 5.5m
Age: 7-adult





Designed to stimulate the user's imagination, our range of Themed Play is fantastic at encouraging imaginative, interactive and social play - as many users can play on these units at once.

From smaller items like the Hobbit Hole - ideal for the school environment where space is limited - right through to the Big Fort - where over 40 people can comfortably use this unit at any one time - our Themed Play offers huge amounts of activity filled fun at excellent prices.

Items such as our Adventure Playforts can be manufactured uniquely for your individual requirements, to be the central and main attraction of your play area. They are enjoyed by all ages and are both visually stimulating and physically challenging.

Bespoke units such as the Playforts can include play facilities such as Slides; Scramble Nets; Ramps; Bridges; Climb Walls; Fireman's Poles; Aerial Runways, etc - as well as 'Turret' and 'Castle' style features.

These items are available with 1m or 1.2m height platforms - these options allow the unit to be installed onto a suitable grass surface without the need for additional safer surfacing. They are also available with a 1.5m (or higher) height platforms with additional safer surfacing.

Please note that where slides are fitted, our large fibreglass Bumpy slide can be fitted onto these items - if the platform height is over 1.2m. Stainless steel slides are also available for these units (additional cost may apply).

Some of these products can also be adapted for users with special needs.

Some of these units can be manufactured from either timber or recycled plastic.

"I would just like to say a huge thank you for all your help with everything regards to the Trim Trail, my son came home and said "that trim trail is ace, well good!" so that's a big thumbs up from me and him, it looks great, thank you."
Mrs Emma Lowe (PTA) - St. Andrews Primary School

(Available without the slide if required)



Item #1502
Choo Choo Train & Slide

Size: 6m x 1m
Space: 8m x 2m
Age: 3-11

Item #1501
Chuff Chuff Log Train

Size: 6m x 0.5m
Space: 8m x 2m
Age: 3-11



Item #0735
Mega Fort

Size: 36.5m x 18m
CFH: 2.2m
Space: 38m x 21m
Age: 3-adult

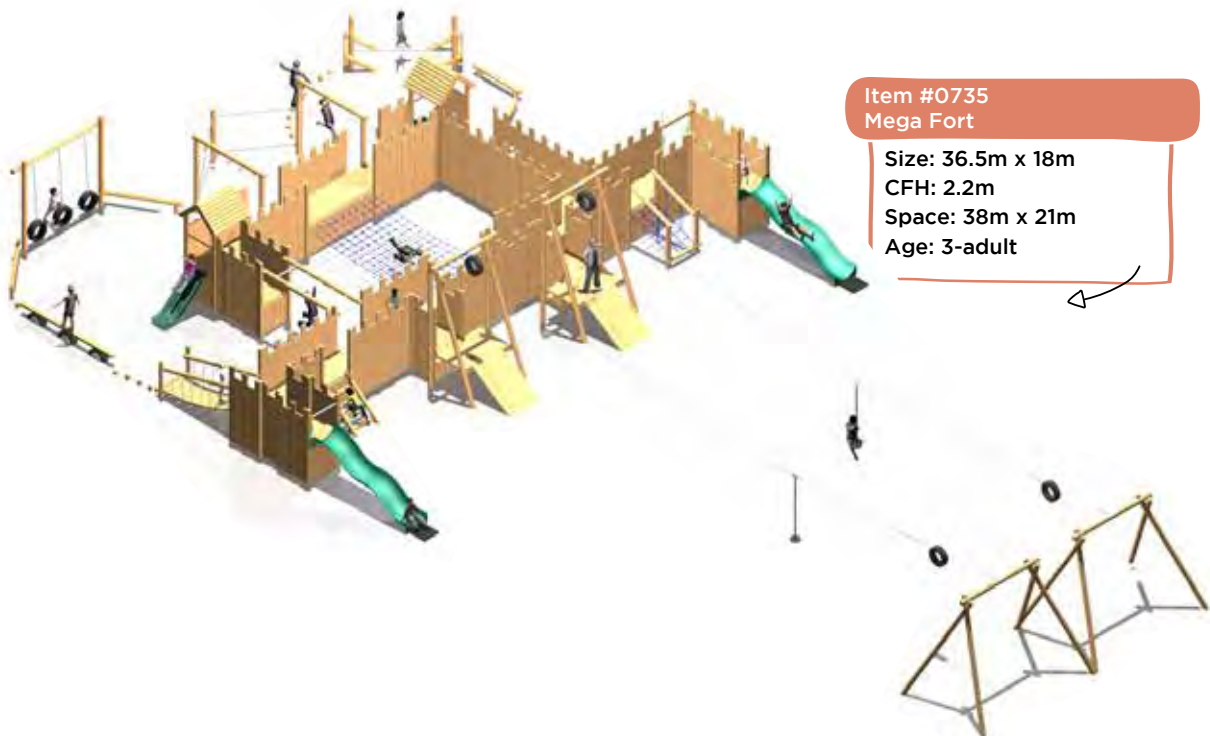

Item #0721
The Guard House

Size: 4.1m x 2.1m
CFH: 1m
Space: 6m x 5m
Age: 5-11

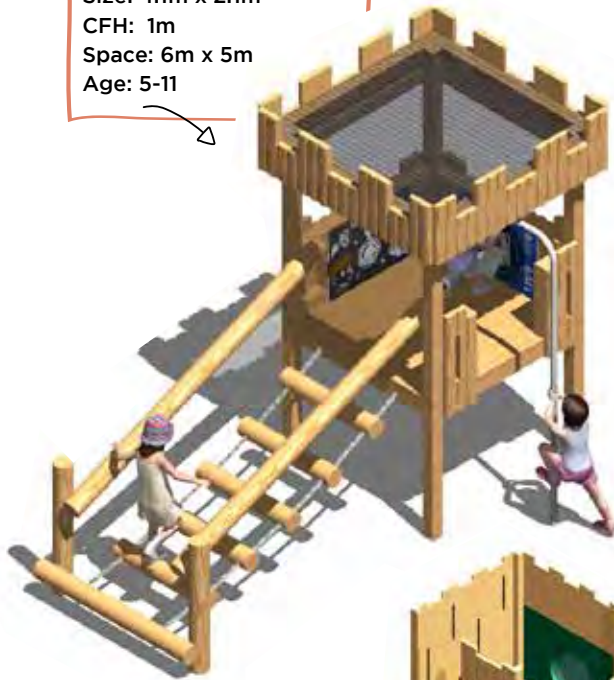

Item #0741
The King Castle

Size: 13.6m x 11.5m
CFH: 1.2m
Space: 16m x 16m
Age: 5-14



Item #0146
The Voyager Ship

Size: 13m x 7m
CFH: 1.4m
Space: 17m x 10m
Age: 5-14



Item #3051
The Imagination Station

Size: 2.8m x 2.8m
Space: 3m x 3m
Age: 3-7

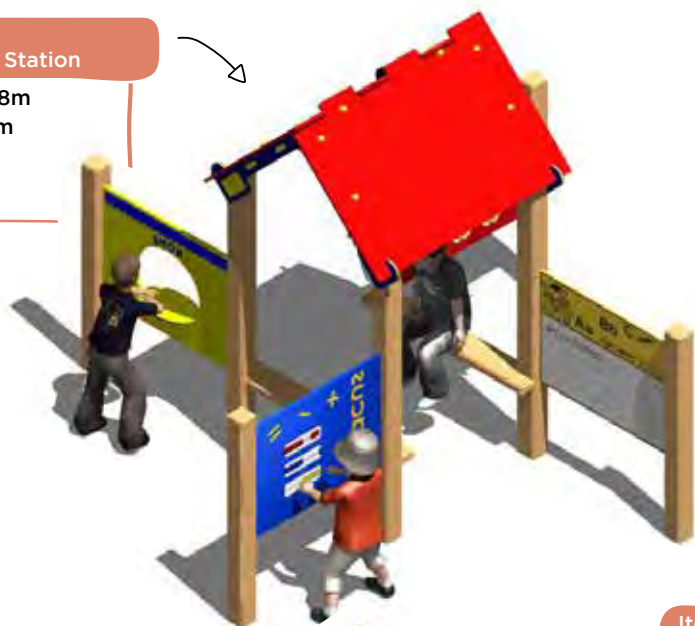

Item #0734
Big Fort

Size: 19m x 19m
CFH: 2m
Space: 22m x 22
Age: 3-adult

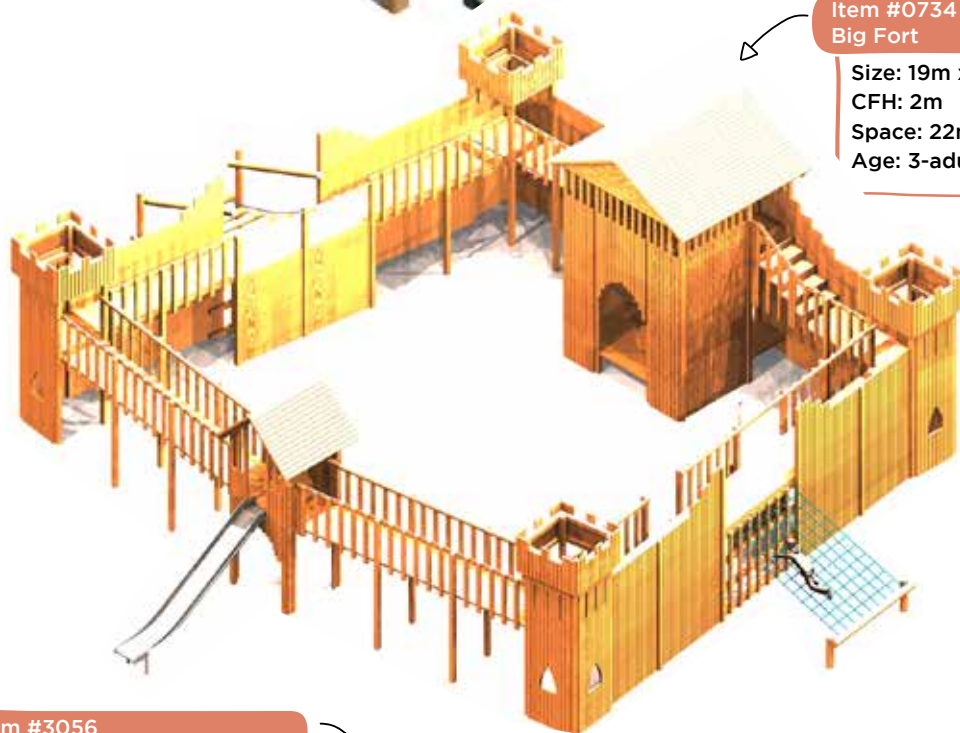

Item #3056
Hobbit Hole

Size: 2m x 1.8m
Space: 3m x 3m
Age: 3-adult





Adventure Climbing frames, great fun for kids of all ages!

We offer a vast range of climbing frames, differing in designs and activities - ranging from the 'Active Play 1' to the 'Crazy Poles'.

So that these climbing frames offer superb value for money, we have designed this range of climbing frames to incorporate as many great play features as possible. These include - Climb Walls, Russian Ring Traverses, Scramble Nets (vertical and horizontal), Rope Ladders, Pole Climbs, Fireman's Poles, Tyre Swings, and Slides (stainless steel or fibreglass available), as well as many other features within each climbing frame.

The climbing frames shown in this range are brilliant at combining numerous play features within a single unit, so they can be installed within relatively small areas.

Because of the design of these items, please note that only some of these units can be manufactured from recycled plastic.

Due to the Critical Fall Heights of the climbing frames, these will require a playground safety surfacing to.

" On behalf of the Parish Council we would like to say a very big thank you for a pleasant experience from start to finish of the whole process. From the moment we contacted the Sales Manager who was most helpful and efficient to the installation team who were very professional and completed the job this week without a hitch. The company have done an excellent job and we would certainly recommend them in the future. We have already had children using the equipment and parents and grandparents thanking the Parish Council for the equipment."

Mrs Laura Storey - Stanley Parish Council

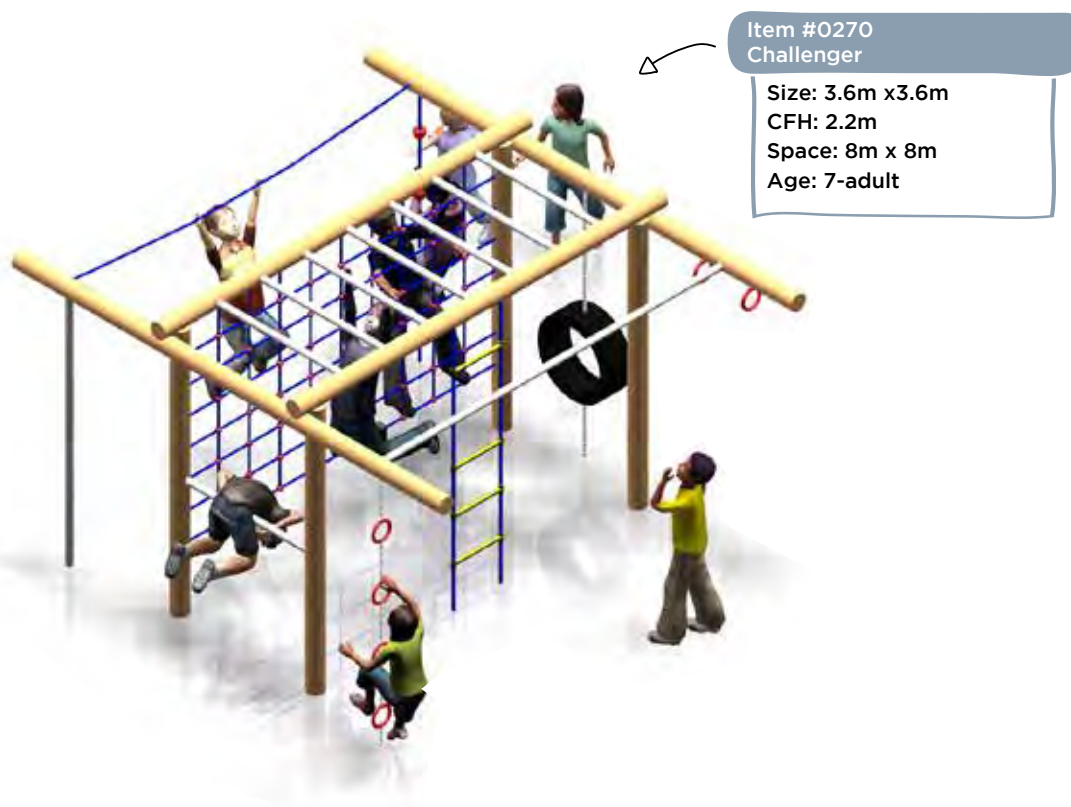
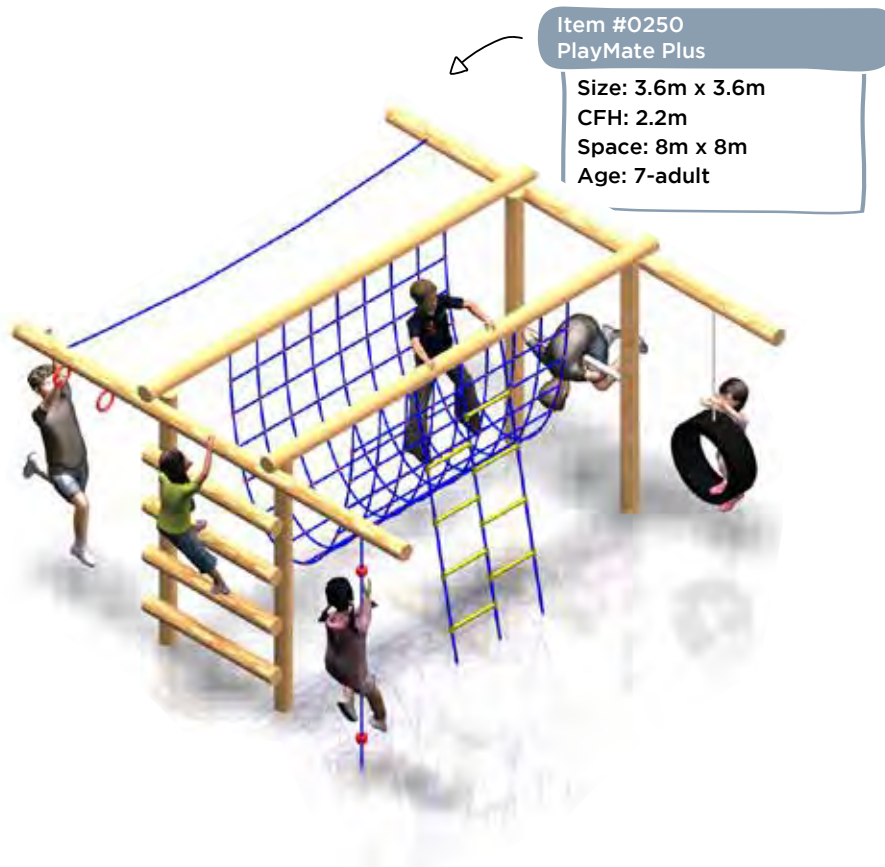

Item #1041
Crazy Poles

Size: 12.5 x 6.7m
CFH: 2.2m
Space: 15m x 10m
Age: 7-adult



Item #1043
Crazy Poles XL

Size: 13m x 8m
CFH: 2.5m
Space: 16m x 12m
Age: 7-adult



Item #0260
PlayMaker

Size: 4m x 3.6m
CFH: 2.2m
Space: 8m x 8m
Age: 7-adult



Item #0131
Active Play 1 (bumpy slide)

Size: 6m x 3m
CFH: 2.1m
Space: 9m x 7m
Age: 7-adult





From the Small Play 3 to the Hexersize Tower, many of the items in the Play Frame range combine various items from the Fun Trail range to create a climbing structure that fits neatly into smaller areas. They are also particularly popular when surfacing is required as these frames keep the overall area size to a minimum whilst still providing the maximum play value.

Items such as the PlayMaster and The Eliminator are also suited for older children and teenagers, as they combine - physical activities such as slides, ramps, and scramble nets - with upper-body strength challenges like Overhead Ladder Bars, Russian Rings, Gym Rings, Vertical Scramble Nets, etc.

The Play Frames range is ideal for play areas in schools or parks where there is only a small - medium amount of space available.

Some of the units in this range available with 600mm; 1m; or 1.2m height platforms - these options allow the unit to be installed onto a suitable grass surface without the need for additional safer surfacing. Some are also available with a 1.5m - 2m platform with additional safer surfacing.

Please note that where slides are fitted, our large fibreglass Bumpy slide can be fitted onto these items - if the platform height is over 1.2m. Note that stainless steel slides are also available for these units (additional cost may apply).

Additional features can be added to most of the items within this range, including ramps, interactive game panels, nets, additional slides, almost anything (within reason!).

Most of these products can also be adapted for users with special needs.

Most of these units can be manufactured from either timber or recycled plastic.



Item #1311
PlayMaster

Size: 9m x 7m
CFH: 2.2m
Space: 12m x 11m
Age: 5-adult



Item #1075
The Hexersize Tower

Size: 8.8m x 6.9m
CFH: 2.5m
Space: 12m x 12m
Age: 5-adult



Item #0180
Low Play 3

Size: 9m x 4m
CFH: 1m
Space: 11m x 6m
Age: 3-adult



Item #0231
Small Play 3

Size: 5.8m x 4.6m
CFH: 0.6m
Space: 8m x 7m
Age: 3-adult



Item #0201
Junior Playtime

Size: 7m x 6m
CFH: 0.6m x 1.2m
Space: 10m x 9m
Age: 3-adult



Item #0342
All Play 3 (high level)

Size: 9.5m x 6.5m
CFH: 2.2m
Space: 13m x 9m
Age: 5-adult



Item #0341
All Play 3 (low level)

Size: 9.5m x 6m
CFH: 0.6m x 1.2m
Space: 13m x 9m
Age: 3-adult



Item #1071
The Activator

Size: 5.2m x 5.1m
CFH: 2m
Space: 8m x 8m
Age: 7-adult



Item #1072
The Eliminator

Size: 6m x 3m
CFH: 2m
Space: 9m x 7.5m
Age: 7-adult





Playground Swings provide classic fun for people of all ages, including adults.

Wherever there have been playgrounds, there have been swings, and so we have some more traditional playground swings and some newer, more adventurous swing sets for public parks and playgrounds.

Our most popular playground and park swings are the Cantilever swing, the Hexagon swing and the Basket Seat swing.

Available in heavy duty timber, and some can be manufactured from recycled plastic.

Swings will require a safety surface, which will offer protection from falls and also help prevent ground erosion.

"Brilliant Responsive Service!
10+/10 Already well used &
enjoyed by public."

Mr Lewis White – Southwark Council

Item #0010
Double Flat Seat Swing

Size: 3.6m x 3.2m
CFH: 1.7m
Space: 8m x 4m
Age: 5-adult



Item #0020
Double Cradle Seat Swing

Size: 3.6m x 3.2m
CFH: 1.6m
Space: 7m x 4m
Age: 3-5



Item #0045
Basket Swing

Size: 3.6m x 3.2m
CFH: 1.6m
Space: 8m x 4m
Age: 3-adult

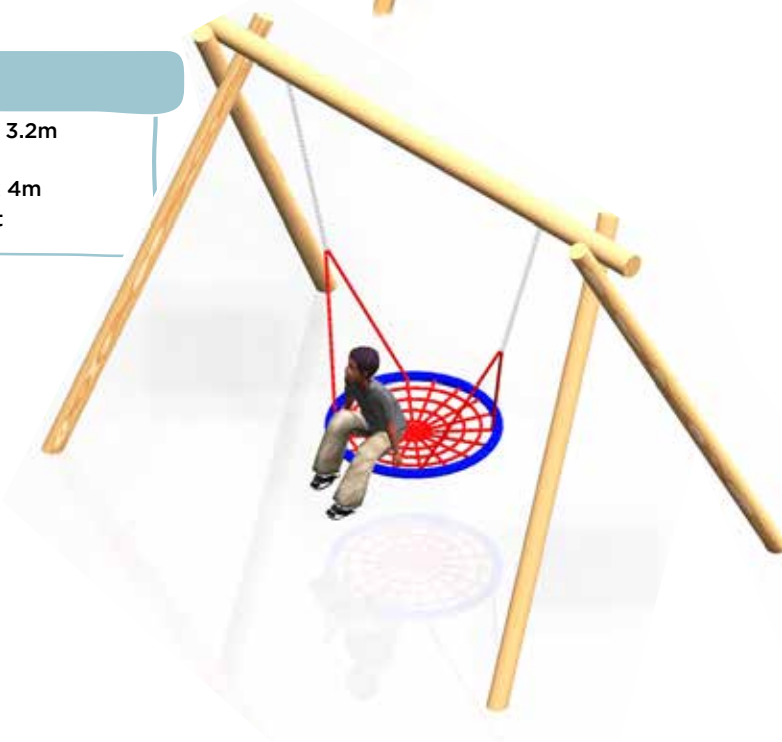



Item #0035
Cantilever Swing & Basket

Size: 4.9m x 3.7m
CFH: 1.8m
Space: 9m x 9m
Age: 3-adult



The Aerial Runway (aka, Cableway, Skyway, Zip Line, Zip Wire, Rope Slide, Death Slide!)

The basic concept is simple: a pulley suspended on a cable usually mounted on an incline.

We offer the Heavy Duty Commercial Aerial Runway from 20m as standard and up to 50m

Our Aerial Runways are extremely popular adventure playground equipment. Wherever an Aerial Runway is installed there's always a queue of kids waiting to have a go! So quite often we have installed 2 side-by-side allowing the kids to race with each other from one end to the other.

Where there is insufficient incline we have built a mound or platforms at the "take-off" end, so these cableways can be built on flat ground too.

We have Timber Aerial Runways available and now a new Steel version is also available.

Item #0693
30m Aerial Runway

Size: 33m x 3m
CFH: 1.6m
Space: 35m x 4m
Age: 5-adult

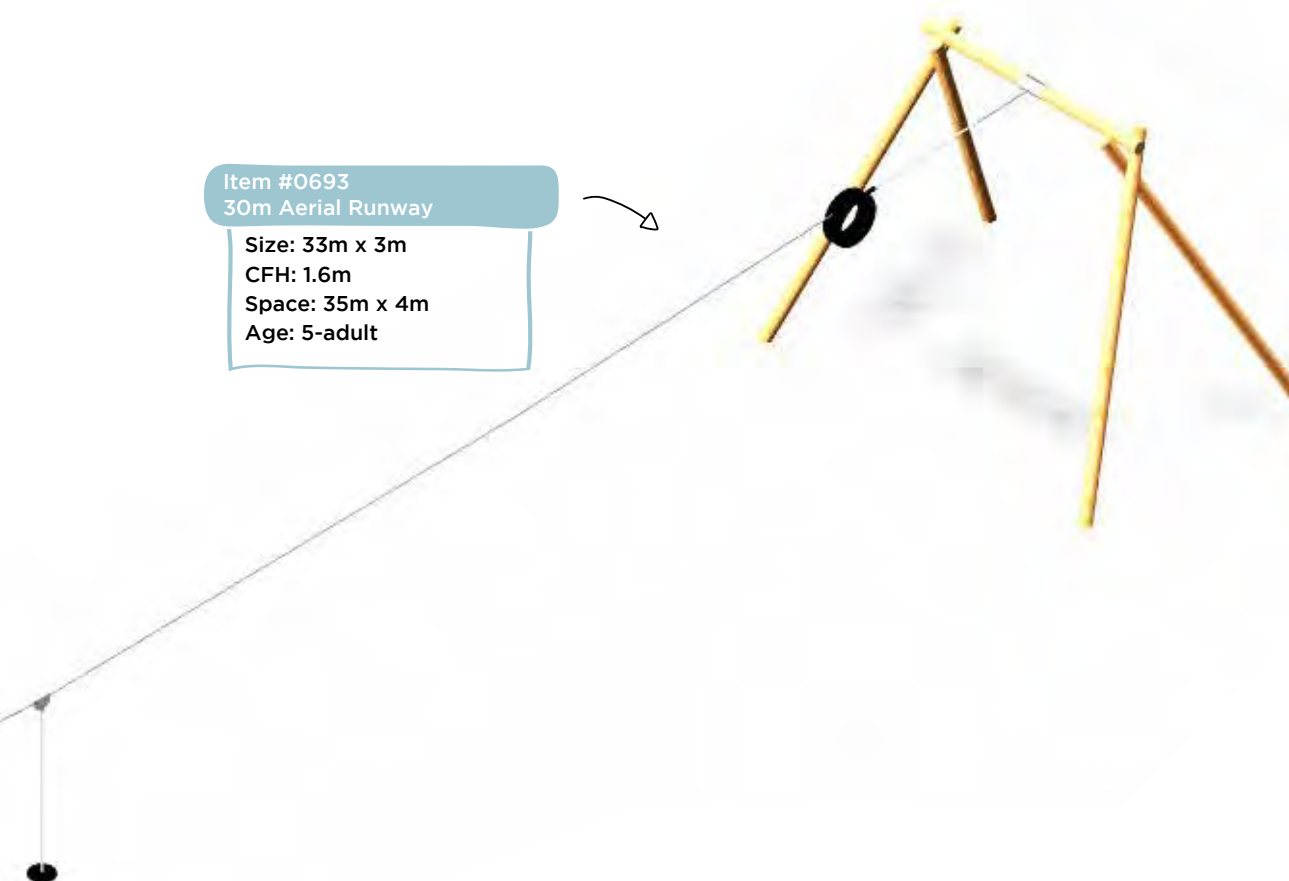

Item #0050
Hexagon Swing

Size: 6.7m x 6m
CFH: 1.7m
Space: 10m x 10m
Age: 5-adult





Create an Outdoor Gym or Outdoor Fitness Area with this range of professionally designed exercise equipment developed specifically for the outdoors, making them accessible to all.

The design makes it safe to use with resistance being provided by the user's own body weight.

All equipment is designed to aid the development of and benefits to one or more of the following areas;

- Strength - Helps to build and tone muscle.
- Cardiovascular - Helps to strengthen the heart and improve heart lung efficiency.
- Flexibility - Stretches muscles, tendons and ligaments and/or increases the range of movement.
- Balance & Co-ordination - Improves reflexes and mind/body interaction.

The Places

The equipment is suited to a wide variety of locations and in fact any open space to be used by anyone with the time to spare.

Many pieces of equipment have already been installed at; Public Playgrounds,

Schools, Colleges, Universities, Recreation Areas, Holiday Parks, Business Parks, Community Areas, Hotels, Motorway Services, Golf Courses, Cruise Ships, Military Bases and more!

The People

This equipment is suitable and accessible to all from teenagers to the elderly and from beginners to the serious athlete.

It is attractive and fun to use so at last everyone can now enjoy the benefits of being outdoors and exercising whilst having fun!

A range of equipment specifically for Children is also available.

The Benefits

Free to use - Accessible to all - Health & Wellbeing - Promotes physical exercise - Low maintenance - Low carbon footprint - Promotes social engagement - Grants available - Vandal resistant construction

Item #6601
Children Air Skier

Space: 4m x 4m
Age: 7-11



Item #6604
Children's Arm & Pedal Bike

Space: 4m x 4m
Age: 7-11



Item #6603
Children's Double Air Walker

Space: 4m x 4m
Age: 7-11



Item #6627
Seated Chest Press

Space: 6m x 4m
Age: 14-adult



Item #6640
Seated Bike

Space: 4m x 4m
Age: 14-adult





Our range of sensory items have been designed to encourage children to explore their other senses, specifically their sense of sound. They also emphasise the use of imagination, sight, touch and co-ordination.

Our range of Outdoor Musical Instruments come complete with Recycled Plastic posts - ready to install.

These items include brightly coloured and very high quality, anodized aluminium finished chimes; recycled plastic posts; and stainless steel fasteners.

Design and create a musical garden with these stimulating items that promote exploration and creativity for young minds.

"I am very proud with what we have achieved. I have nothing but praise for the dealings I have had with PlayQuest."

Mrs Coral Beresford – Shobnall Parish Council

Item #3180
Eco-Chimes

Size: 1.4m x 1.2m
Space: 2m x 1m
Age: 3-adult



Item #3181
Eco-Chimes Quartet

Size: 1.4m x 0.27m
Space: 1m x 1m
Age: 3-adult



Item #3182
Eco bongos

Size: 1m x 0.9m
Space: 2m x 1m
Age: 3-adult



Item #3183
Eco-Rain Wheel

Size: 1m x 0.6m
Space: 1m x 1m
Age: 3-adult



Item #3184
Eco- multi chimes 4

Size: 1.4m x 0.12m
Space: depends on layout
Age: 3-adult



Item #3185
Eco- multi chimes 8

Size: 1.4m x 0.12m
Space: depends on layout
Age: 3-adult



PlayTronic - Drum Kit



PlayTronic - Driving Panel

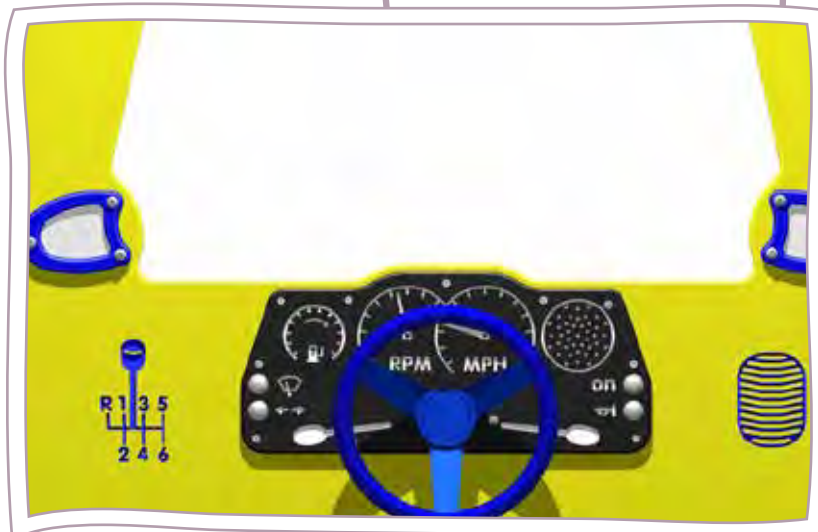

PlayTronic - Colours

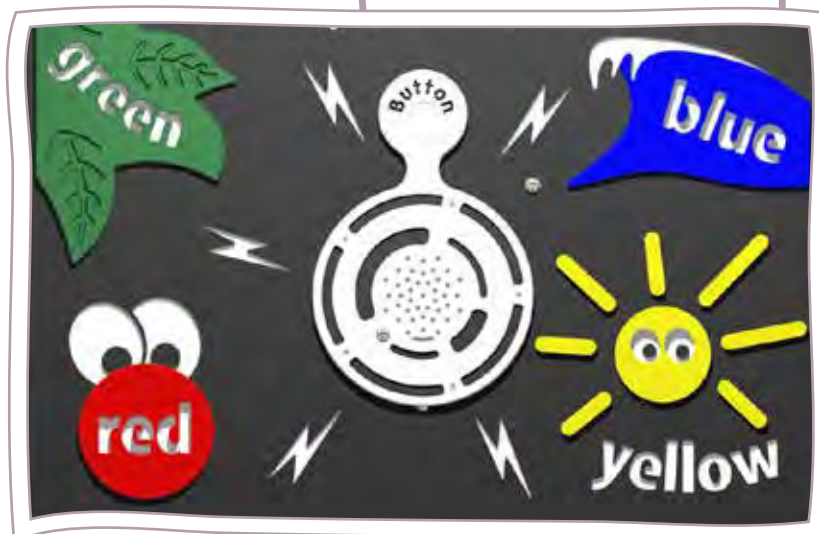

Arts & Crafts - Chalk Board



Arts & Crafts - Paint Board



Arts & Crafts - Dry Wipe Board

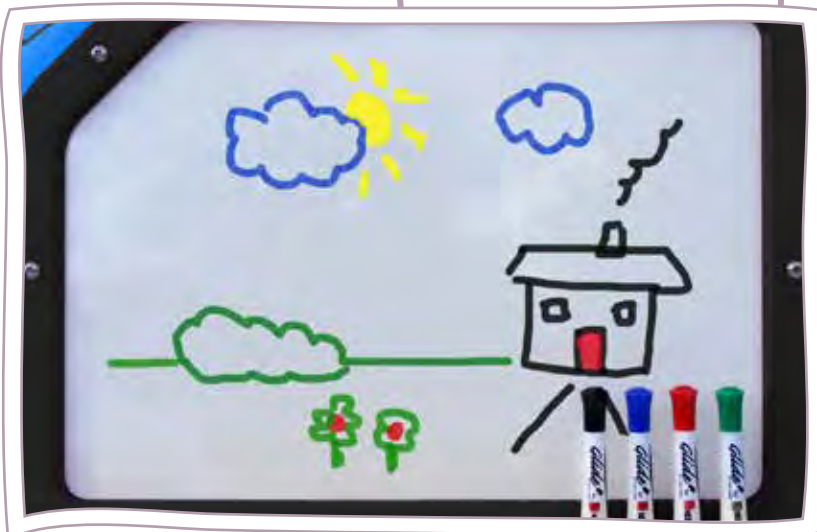



Activity Climbing Nets are especially suited for children aged 5 to 12, providing hours of fun and helping in developing climbing skills.

These Nets are available in a choice of rope colours, including red, green and blue, and can be made to order in single, two tone or triple colour variations at no additional cost.

Offering high play value, robust construction, strength and durability, not to mention its bold visual impact, the Activity Nets are prerequisites for any small to medium sized play area. Cone-climbers add a new and alternative dimension to play areas of any size, and are particularly suited to smaller schemes where space and play value are paramount.

Cone-climbers are rotating, 3-dimensional, climbing structures available in a number of differing sizes, whilst offering superb material specification as well as great play value for children aged from 3 years upwards.

The Cone-Climbers are also available in a selection of colours at no additional cost. With stainless steel mast, braided rope and hidden rotating components this product is highly durable, safe and made to last.

"I would like to commend your team of workers. We were quite astonished at the way in which they approached their work. They were well organised very efficient and above all, they must rank among the hardest working team of workers we have ever had working at the school. I was so impressed that I complimented them myself on completion of the work."

Mrs M Fitzpatrick — St. Mary's RC Parish School, Birmingham.



Item #3204
4m Actiity Net

Size: 6.6m x 6.6m
CFH: 0.6m
Space: 9.5m x 9.5m
Age: 5-adult

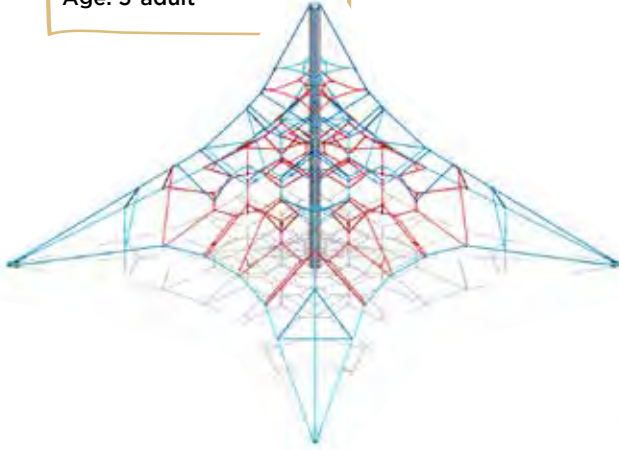

Item #3324
2.4m Cone Climber

Size: 2.15m x 2.15m
CFH: 0.35m
Space: 6m x 6m
Age: 3-14

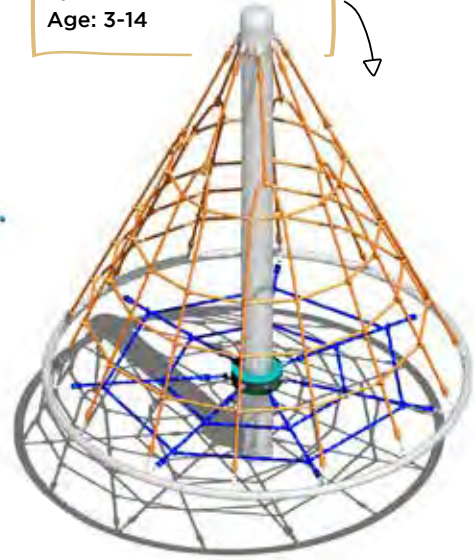

Item #3850
Revolve Roundabout (wheelchair)

Size: 2m x 2m
Space: 6m x 6m
Age: 3-adult



Item #3860
Orbiter Roundabout

Size: 1.5m x 1.5m
Space: 5m x 5m
Age: 5-adult





All our Springers have been designed and manufactured in compliance with EN1176 and are certified by TÜV-RHEINLAND in Cologne.

The figures of the springers are all manufactured from HDPE, treated against UV rays, and are completely recyclable.

All fittings are manufactured using both stainless and galvanized steel.

Our standard See-Saws come with galvanized steel hardware and are available in timber or recycled plastic.

"I would like to commend your team of workers. We were quite astonished at the way in which they approached their work. They were well organised very efficient and above all, they must rank among the hardest working team of workers we have ever had working at the school. I was so impressed that I complimented them myself on completion of the work." — Mrs M Fitzpatrick, St. Mary's RC Parish School, Birmingham.



Item #4323
Car Springer

Size: 0.8m x 0.5m
CFH: 1m
Space: 3m x 3m
Age: 3-5



Item #4503
Motorbike Springer

Size: 0.7m x 0.25m
CFH: 1m
Space: 3m x 3m
Age: 3-5

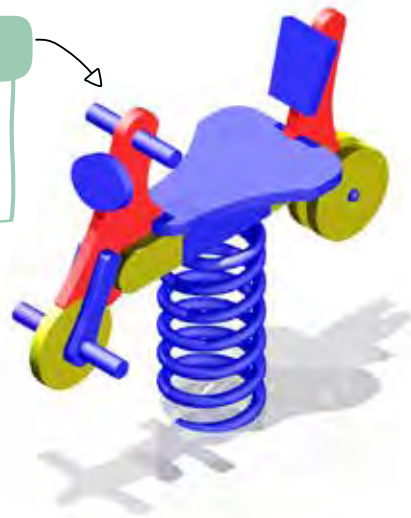

Item #1410
Timber See-Saw

Size: 3.6m x 0.15m
CFH: 1.2m
Space: 6m x 3m
Age: 5-adult

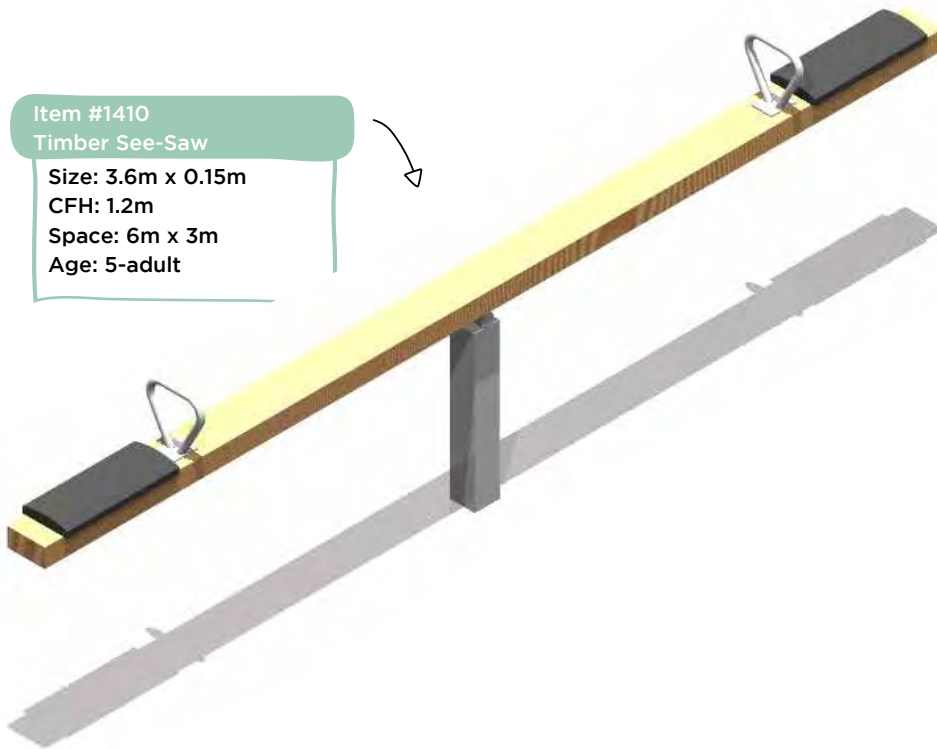



Our range of shelters and outdoor classrooms are popular with both schools and nurseries, as they are ideal for either teaching pupils outside during nice weather, or for parents waiting to collect their children from school.

These are very heavy duty, hand-made focal points that offer protection from the elements, whilst providing a useful, outdoor teaching area.

All of our shelters and outdoor classrooms can be made to suit your individual requirements, and can include additional seating, tables, and even interactive game panels.

All of our shelters and outdoor classrooms are hand-crafted using heavy-duty materials, which make them ideal for the school environment. Decked timber flooring is also available for our shelters and outdoor classrooms.

Also available are Shade Sails and Waterproof Canopies - please contact us for further information regarding types, sizes and colours available.

Item #7033
3m Octagonal Outdoor

Size: 3m x 3m
Space: 4m x 4m
Age: 3-adult



Item #7344
4m x 4m Square

Size: 4m x 4m
Space: 5m x 5m
Age: 3-adult

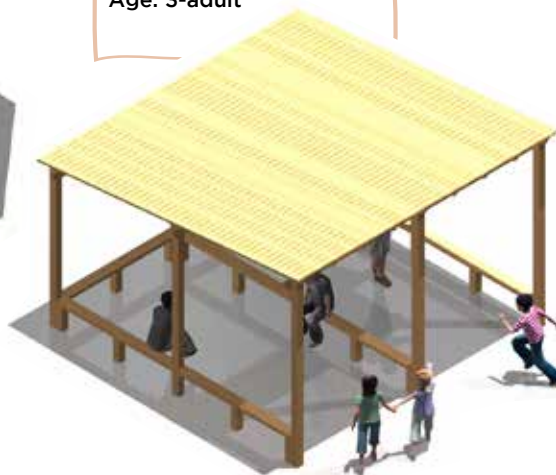



At PlayQuest, we recognise that the choices we make regarding the materials we use in our play equipment will have an impact in everyday life.

That is why since the year 2000, we have been designing and manufacturing play equipment using environmentally-friendly recycled plastic, and we are a market leader in providing play equipment / play areas from recycled plastic.

The recycled plastic we use for our equipment is of a very high quality grade, which means that the recycled plastic material used does not rot nor splinter, will last decades and is virtually maintenance free.

Recycled plastic products contribute to a better environment as they are made from recycled material and not chemically treated in any way, therefore there are no harmful effects to the environment. Another benefit is that, if necessary the sustainable plastic can be recycled again.

Recycled Plastic is produced from waste plastic collected by kerbside recycling schemes. By replacing timber products with recycled plastic equivalents, we are assisting in reducing carbon emissions, as well as helping to save our precious forests.

Regarding the anticipated lifespan of recycled plastic, we anticipate that this will be at least three-times the estimated lifespan of the same equipment manufactured from timber, as recycled plastic will not rot once installed and only minimum maintenance is required.

Most of our range of play equipment can be manufactured from recycled plastic, as well as other items such as Fencing, Benches, Picnic Tables, Waste Bins, etc.





Vertical Infill Fence - Vertical Infill Fencing manufactured from either heavy-duty grade timber or recycled plastic. Manufactured to comply with current safety guidelines.

Available as standard in both 1m and 2m heights, however we can also manufacture this fencing to suit your unique requirements.

Self-closing single and double gates are also available to suit your needs.

Fencing is also available complete with a retaining edge for loose-fill safer surfacing.

The Vertical Infill Fencing and Gates are also available in Recycled Plastic.

Barrier Fencing - Ideal to provide a safety barrier for play equipment such as Swings and Aerial Runways to maximise safety during the use of these items. This fencing can also be manufactured from either heavy-duty grade timber or recycled plastic.

Steel Bow-Top - Steel Bow Top Fencing - TR800-3G.

RoSPA compliant perimeter security fencing up to 1.8m metres high.

Resistant to vandalism, Steel Bow Top fencing is frequently preferred by Local Authority planners as a more acceptable, attractive alternative to traditional Palisade fencing for children's playgrounds within both the school and public domain.

TR800-3G is ideal for the school environment, as it can be used to segregate areas whilst keeping a bright, colourful and fresh look to the play area.

This fencing can either be left galvanised or powder coated in a variety of RAL colours: red, green, blue, yellow, etc and is also available in a multi-coloured 'Rainbow' finish.

Garden Furniture - We offer High quality, robust, long lasting Street and Park Furniture, Park Benches, Picnic Benches, Planters, School Playground Benches, Park Furniture including Tables and Chairs, in Timber and Heavy-Duty Recycled Plastic.

Our recycled plastic furniture is extremely heavy duty and has an expected lifespan in excess of 30 years!

(Also available in Recycled Plastic)



Item #2911
Vertical Infill fencing
Size: 1m - 2m high



Item #2971
Steel Bow - Top Fencing
Size: 1m - 1.8m high

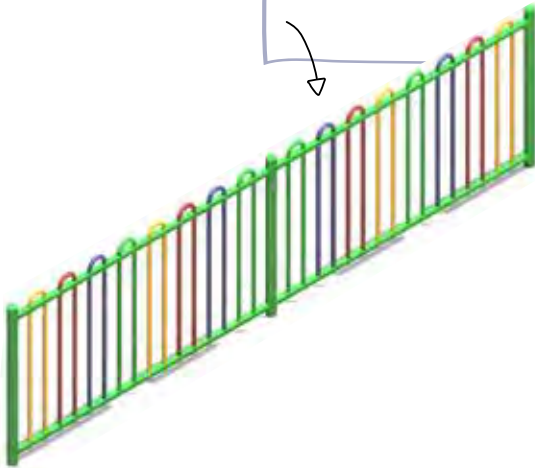

Item #5501
Timber Waste Bin
Size: 0.5m x 0.5m

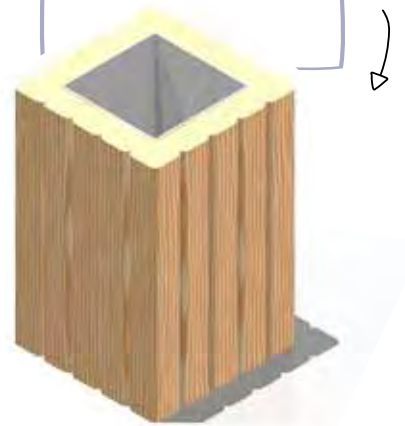

Item #2605
Forest Bench
Size: 1.6m x 0.9m
Space: 2m x 1m



Item #2651
Picnic Table
Size: 1.2m x 1.3m
Space: 1.5m x 1.5m

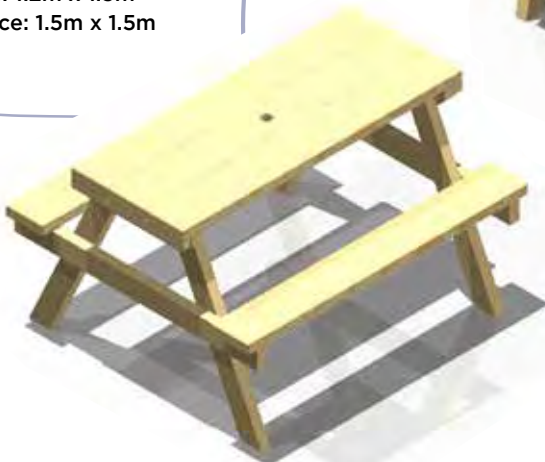

Wetpour



Wetpour - Wetpour rubber playground surfacing is designed to improve the safety and appearance of any play area.

It is a cost-effective and maintenance free solution for play area providers looking to install a play safety surface.

Available in a wide range of colours it is the preferred choice for many council playgrounds, although many schools now choose wet-pour surfacing if installing playground equipment onto tarmac.

We offer a bespoke design service for new or existing playgrounds requiring a new wet pour installation.

Our trained installers work at schools around the UK and we have safety as our priority.

This poured rubber playground surface can be installed during term time with minimal disruption for the school.

Wet pour installation onto grass requires a sub-base. This can be excavated or raised above the ground level with a surrounding edge.

Bark



Woodchip & Bark - With the ever growing concerns for conservation and our environment, our woodchip and bark safer surfacing help to keep the natural timber look to a play area.

We offer loose-fill surfacing as bagged or loose for self-installation or for us to install for you, at very competitive rates.

Our Woodchip and bark is suitable for Commercial and Residential Play Areas.

All of our surfacing has been tested to BS EN 1177. Certificates available upon request.

Note: To calculate required surfacing in cubic metres, multiply the width by the length and then multiply by the depth. E.g.. 5m (width) x 10m (length) x 0.3m (depth) = 15cubic metres.

PlayBond



PlayBond - PlayBond is installed on site using a mixture of fine recycled rubber shred and binder, and can easily be installed around both new and existing play equipment.

PlayBond is also suitable for installation in landscaping areas - such as pathways, seating areas, etc. PlayBond is suitable for installation in the school environment, as well as caravan parks, open play areas, etc.

SOME BENEFITS OF PLAYBOND ARE:-

- **Can be shaped around existing equipment flawlessly.**
- **Can be installed straight onto grass with only a membrane to install.**
- **Generally cheaper than Wetpour.**
- **Manufactured from 100% recycled shredded rubber.**
- **No edging required!**
- **Can be installed straight over an existing surface.**
- **No need to install a sub base.**
- **Porous material so that water drains through - can be used year-round.**
- **Variety of colours available.**
- **Longer lasting than Loose-fills.**
- **Natural looking finish.**
- **Eco-friendly material.**

Travel Mat



Travel Mat - Travel Mats safer surfacing is the most popular of the safer surfacing that we offer. Virtually maintenance free, the Travel Mats allow the grass to grow through - thus allowing your play area to retain the natural look.

Travel Mats are ideal for Play Areas, Walkways, Embankments, Golf Courses & Gardens.

Travel Mats are installed with a Ground Stabilizing Mesh, Pegs, Ties, and Grass Seed to promote the natural growth.

BENEFITS OF THE TRAVEL MATS ARE:

- Available in 22mm and 16mm thickness.
- Critical Fall Height of over 2.5m, tested by RAPRA to BS EN 1177 (22mm).
- An environmentally friendly, impact absorbing safety surface.
- Moulded non-slip cellular structure with excellent durability and comfort.
- Requires no special skills or tools allowing a quick and easy installation.
- No costly base works (as required for conventional tiles or wet-pour).
- Ideal for green field sites, disappears from view once turf has re-grown.
- Suitable for all weather, extreme temperatures and resists wind uplift.
- Can be used on flat or contoured landscapes.
- Large openings of 2.5cm diameter allow liquid and debris to drain, keeping surface dry and clean.
- Absorbs shock and noise.
- Protects floor and equipment.
- Pours surface so that water drains through - can be used year-round.



Contact

t: 01745 561 117

e: sales@playquest.co.uk

w: www.playquest.co.uk